

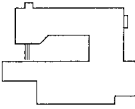

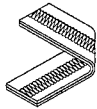

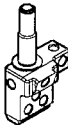

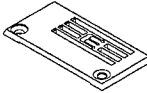

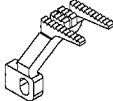
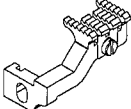
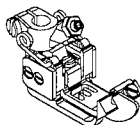



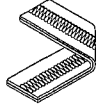
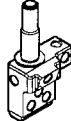
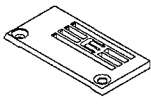
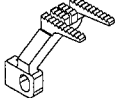
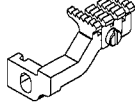
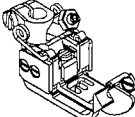
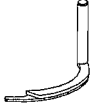

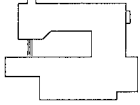
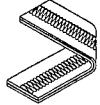
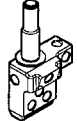
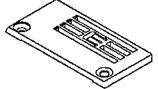
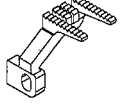
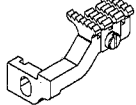
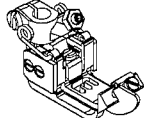
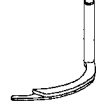

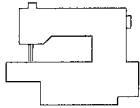
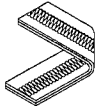
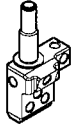
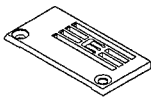
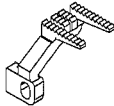
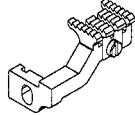
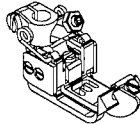

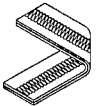
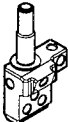
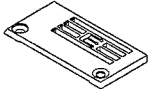
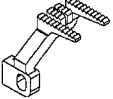
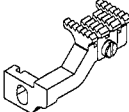
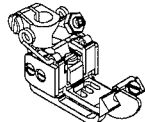

SIRUBA GAGE PARTS LIST		Series			Remark					Page	Date
		C007K/C007KD C858K								1 / 7	2016/9/7
											
MODEL		SUB-CLASS	NEEDLE CLAMP	NEEDLE PLATE	MAIN FEED DOG	DIFF. FEED DOG	PRESSER FOOT	SPREADER	LOOPER	NEEDLE	
機 型		規 格	針 座	針 板	主 送 具	差 送 具	押 具	上 叉	勾 針	針 號	
C007K(KD) C858K	W121/CH			E5232KL E5240KL E5248KL E5348KL E5356KL E5364KL	D5356K	H5356KA-E	P5232A-A P5240A-A P5248A-A P5348A-A P5356A-A1 P5364A-A1	MH41	MT01	UYX128GAS#9	
	W122/CH	232 240 248 348 356 364	M5232 M5240 M5248 M5348KX M5356 M5364	E5232KM E5240KM E5248KM E5348KM E5356KM E5364KM						UYX128GAS#10	
	W122/CH-3M	356 364	M5356 M5364	E5356KM E5364KM						P2456-A P2457-A	
	W123/CH	232 240 248 348 356 364	M5232 M5240 M5248 M5348KX M5356 M5364	E5232KH E5240KH E5248KH E5348KH E5356KH E5364KH						P5232A-A P5240A-A P5248A-A P5348A-A P5356A-A1 P5364A-A1	
	W152/CZ/UTP/RLQ									P2416-A P2417-A	
	W152/CZP/RLQ	356 364	M5356 M5364	E5356GM E5364GM							D5356G H5356L



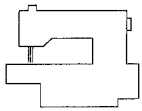
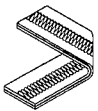
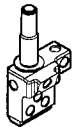
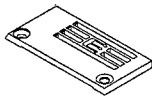
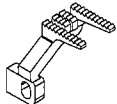
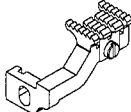
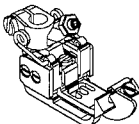

SIRUBA MODEL COMPARE LIST		Series				Remark				Page	Date	
		C007K/C007KD C858K								2 / 7	2016/9/7	
												
MODEL		SUB-CLASS	NEEDLE CLAMP	NEEDLE PLATE	MAIN FEED DOG	DIFF. FEED DOG	PRESSER FOOT	SPREADER	LOOPER	NEEDLE		
機 型		規 格	針 座	針 板	主 送 具	差 送 具	押 具	上 叉	勾 針	針 號		
C007K(KD) C858K	W162/CH	240 248 348 356 364	M5240 M5248 M5348KX M5356 M5364	E5240KHA E5248KHA E5348KHA E5356KHA E5364KHA	D5356K	H5356KA-E	P5240A-A P5248A-A P5348A-A P5356A-A1 P5364A-A1	MH41	MT01A	TV*5#14~16		
	W222/CQ	240 248 356 364	M5240 M5248 M5356 M5364	E5240GM E5248GM E5356GM E5364GM	D5356G	H5356GA	P1814K-A P1815K-A P2116K-A P2117K-A	MH41	MT01	UYX128GAS#10		
	W222/CQA/CLA	256 356	M5356	E2326Q	D2110	H2220Q	P2906Q-A	MH41	MT01A	TVX5#14		
	W322/CC	356 364	M5356	E5356AM E5364AM	D5356K	H5356AA	P2456-A P2457-A	MH41	MT01	UYX128GAS#10		
	W322/CE		M5364	E5356BM E5364BM		H5356BA						
C007K C858K	W512/FE(FFC)	232 240 356 364	M5232 M5240 M5356 M5364	E5232FM E5240FM E5356FM E5364FM	D5356K	H5356KA-E	P2913-A P2914-A P3216-A P3217-A				MT01	UYX128GAS#10
	U512/FE(FFC)	240 356 364	M5240 M5356 M5364	E5240FM E5356FM E5364FM			P3414-A P3716-A P3717-A					





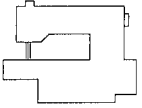
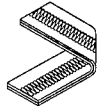
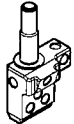
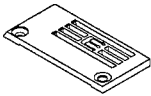
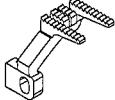
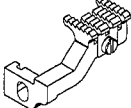
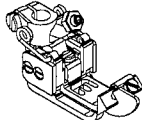

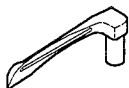
SIRUBA GAGE PARTS LIST		Series				Remark				Page	Date
		C007K/C007KD C858K								3 / 7	2016/9/7
											
MODEL		SUB-CLASS	NEEDLE CLAMP	NEEDLE PLATE	MAIN FEED DOG	DIFF. FEED DOG	PRESSER FOOT	SPREADER	LOOPER	NEEDLE	
機 型		規 格	針 座	針 板	主 送 具	差 送 具	押 具	上 叉	勾 針	針 號	
C007K C858K	W522/FE(FFC)/CR	232 240 248 348 356 364	M5232 M5240 M5248 M5348KX M5356 M5364	E5232CH E5240CH E5248CH E5348CH E5356CH E5364CH	D5356C	H5356CA	P3813R-A1 P5240C-A1 P5248C-A1 P5348C-A1 P3816R-A1 P3817R-A1	MH41	MT01	UYX128GAS#10	
C007K(KD) C858K	W522/CR						P5232R-A P5240R-A P5248R-A P5348R-A P5356R-A P5364R-A				
	W532/CR/UTP/CL/RLP/CX										
C007K C858K	W542/CFC/CL/FH/2(3A)	240 248 356 364	M5240 M5248 M5356 M5364	E2324P E2325P E2326P E2327P	D2109 D2110	H2219 H2220	P2904-A P2905-A P2906-A P2907-A				
C007K(KD) C858K	W811/CRL	232 240 248 356 364	M5232 M5240 M5248 M5356 M5364	E5232ML E5240ML E5248ML E5356ML E5364ML	D5356H	H5356MA	P2763-A P2764-A P2765-A P2766-A P2767-A	—		UYX128GAS#9	
	U811/CRL						P0963-A P0964-A P0965-A P0966-A P0967-A				



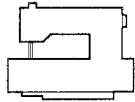
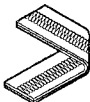

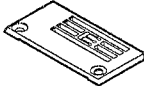
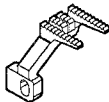
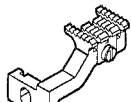
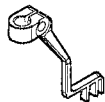
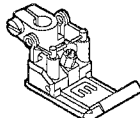
SIRUBA MODEL COMPARE LIST		Series			Remark					Page	Date
		C007K/C007KD C858K			W812 /W813 : 4rof teeth W812A/W813A : 5rof teeth					4 / 7	2016/9/7
											
MODEL		SUB-CLASS	NEEDLE CLAMP	NEEDLE PLATE	MAIN FEED DOG	DIFF. FEED DOG	PRESSER FOOT	SPREADER	LOOPER	NEEDLE	
機 型		規 格	針 座	針 板	主 送 具	差 送 具	押 具	上 叉	勾 針	針 號	
C007K(KD) C858K	W811A/CRL	232 240 248 356 364	M5232 M5240 M5248 M5356 M5364	E5232NL E5240NL E5248NL E5356NL E5364NL	D5356H	H5356NA	P2763-A P2764-A P2765-A P2766-A P2767-A	MH41	MT01	UYX128GAS#9	
	U811A/CRL						P0963-A P0964-A P0965-A P0966-A P0967-A	—			
	W812/CRL			E5232MM E5240MM E5248MM E5356MM E5364MM		H5356MA	P2763-A P2764-A P2765-A P2766-A P2767-A	MH41		UYX128GAS#10	
	U812/CRL						P0963-A P0964-A P0965-A P0966-A P0967-A	—			
	W812A/CRL			E5232NM E5240NM E5248NM E5356NM E5364NM		H5356NA	P2763-A P2764-A P2765-A P2766-A P2767-A	MH41			
	U812A/CRL						P0963-A P0964-A P0965-A P0966-A P0967-A	—			



SIRUBA MODEL COMPARE LIST		Series				Remark				Page	Date
		C007K/C007KD C858K				W812 /W813 : 4rof teeth W812A/W813A : 5rof teeth				5 / 7	2016/9/7
											
MODEL		SUB-CLASS	NEEDLE CLAMP	NEEDLE PLATE	MAIN FEED DOG	DIFF. FEED DOG	PRESSER FOOT	SPREADER	LOOPER	NEEDLE	
機 型		規 格	針 座	針 板	主 送 具	差 送 具	押 具	上 叉	勾 針	針 號	
C007K(KD) C858K	W813/CRL	232 240 248 356 364	M5232 M5240 M5248 M5356 M5364	E5232MH E5240MH E5248MH E5356MH E5364MH	D5356H	H5356MA	P2763-A P2764-A P2765-A P2766-A P2767-A	MH41	MT01	UYX128GAS#10	
	U813/CRL						P0963-A P0964-A P0965-A P0966-A P0967-A	—			
	W813A/CRL			P2763-A P2764-A P2765-A P2766-A P2767-A		MH41					
	U813A/CRL			P0963-A P0964-A P0965-A P0966-A P0967-A		—					
	W821/CRL/CHP/UTP/CL/RL			E5232ML E5240ML E5248ML E5356ML E5364ML		H5356MA	P2763-A P2764-A P2765-A P2766-A P2767-A	MH41			
	U821/CRL/CHP/UTP/CL/RL						P0963-A P0964-A P0965-A P0966-A P0967-A	—			

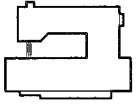
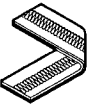
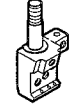
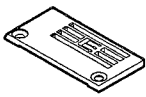
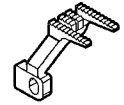
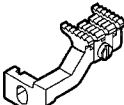
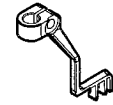
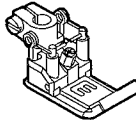

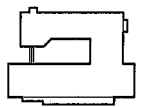
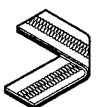
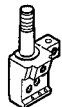
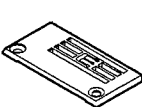
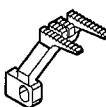
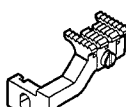
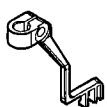
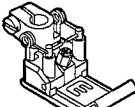
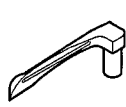

SIRUBA GAGE PARTS LIST		Series				Remark				Page	Date
		C007K/C007KD C858K								6 / 7	2016/9/7
											
MODEL		SUB-CLASS	NEEDLE CLAMP	NEEDLE PLATE	MAIN FEED DOG	DIFF. FEED DOG	PRESSER FOOT	SPREADER	LOOPER	NEEDLE	
機 型		規 格	針 座	針 板	主 送 具	差 送 具	押 具	上 叉	勾 針	針 號	
C007K(KD) C858K	W821A/CRL/CHP/UTP/CL/RL	232 240 248 356 364	M5232 M5240 M5248 M5356 M5364	E5232NL E5240NL E5248NL E5356NL E5364NL	D5356H	H5356NA	P2763-A P2764-A P2765-A P2766-A P2767-A	MH41	MT01	UYX128GAS#9	
	U821A/CRL/CHP/UTP/CL/RL			P0963-A P0964-A P0965-A P0966-A P0967-A			—				
	W822/CRL/CHP/UTP/CL/RL			P2763-A P2764-A P2765-A P2766-A P2767-A		MH41	UYX128GAS#10				
	U822/CRL/CHP/UTP/CL/RL			P0963-A P0964-A P0965-A P0966-A P0967-A		—					
	W822A/CRL/CHP/UTP/CL/RL			E5232NM E5240NM E5248NM E5356NM E5364NM		H5356NA	P2763-A P2764-A P2765-A P2766-A P2767-A	MH41			
	U822A/CRL/CHP/UTP/CL/RL			P0963-A P0964-A P0965-A P0966-A P0967-A			—				

SIRUBA GAGE PARTS LIST		Series				Remark			Page	Date	
		C007K/C007KD C858K							7/7	2016/9/7	
											
MODEL		SUB-CLASS	NEEDLE CLAMP	NEEDLE PLATE	MAIN FEED DOG	DIFF. FEED DOG	PRESSER FOOT	SPREADER	LOOPER	NEEDLE	
機 型		規 格	針 座	針 板	主 送 具	差 送 具	押 具	上 叉	勾 針	針 號	
C007K(KD) C858K	W823/CRL/CHP/UTP/CL/RL			E5232MH E5240MH E5248MH E5356MH E5364MH		H5356MA	P2763-A P2764-A P2765-A P2766-A P2767-A	MH41	MT01	UYX128GAS#10	
	U823/CRL/CHP/UTP/CL/RL						P0963-A P0964-A P0965-A P0966-A P0967-A	—			
	W823A/CRL/CHP/UTP/CL/RL	232 240 248 356 364	M5232 M5240 M5248 M5356 M5364	E5232NH E5240NH E5248NH E5356NH E5364NH		D5356H	H5356NA	P2763-A P2764-A P2765-A P2766-A P2767-A			MH41
	U823A/CRL/CHP/UTP/CL/RL							P0963-A P0964-A P0965-A P0966-A P0967-A			—
	W922/CW	456 460 464	M5456K M5460K M5464K	E5456KM E5460KM E5464KM		D5456K	H5456KA-E	P5456K-A P5460K-A P5464K-A			MH41

SIRUBA GAGE PARTS LIST		Series				Remark					Page	Date
		C007KD				USE FOR FFT					1 / 4	2016/8/26
												
MODEL	SUB-CLASS	NEEDLE CLAMP	NEEDLE PLATE	MAIN FEED DOG	DIFF. FEED DOG	TOP FEED DOG	PRESSER FOOT	LOOPER	SPREADER	NEEDLE		
機型	規格	針座	針板	主送具	差送具	上送具	壓具	勾針	上叉	使用針		
W121/FFT/CH	240 248 356 364	M5240 M5248 M5356 M5364	E5240KL E5248KL E5356KL E5364KL	D5356K	H5356KA-E	F7356N	P7240N-A P7248N-A P7356N-A P7364N-A	MT01	MH41	UYX128GAS#9		
W121/FFT/CH /UTP(UTR)	240 248 356 364	M5240 M5248 M5356 M5364	E5240KL E5248KL E5356KL E5364KL	D5356K	H5356KA-E	F7356N	P7240N-A P7248N-A P7356N-A P7364N-A	MT01	MH41	UYX128GAS#9		
W122/FFT/CH	240 248 356 364	M5240 M5248 M5356 M5364	E5240KM E5248KM E5356KM E5364KM	D5356K	H5356KA-E	F7356N	P7240N-A P7248N-A P7356N-A P7364N-A	MT01	MH41	UYX128GAS#10		
W122/FFT/CH /UTP(UTR)	240 248 356 364	M5240 M5248 M5356 M5364	E5240KM E5248KM E5356KM E5364KM	D5356K	H5356KA-E	F7356N	P7240N-A P7248N-A P7356N-A P7364N-A	MT01	MH41	UYX128GAS#10		

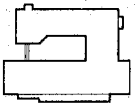
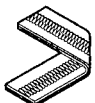
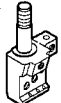
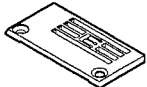
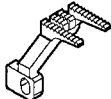
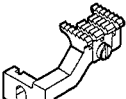
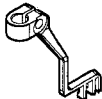
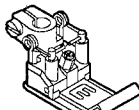
SIRUBA GAGE PARTS LIST		Series				Remark					Page	Date
		C007KD				USE FOR FFT					2 / 4	2015/11/24
												
MODEL	SUB-CLASS	NEEDLE CLAMP	NEEDLE PLATE	MAIN FEED DOG	DIFF. FEED DOG	TOP FEED DOG	PRESSER FOOT	LOOPER	SPREADER	NEEDLE		
機 型	規 格	針 座	針 板	主送具	差送具	上送具	壓 具	勾 針	上 叉	使用針		
W131/FFT/CH	240 248 356 364	M5240 M5248 M5356 M5364	E7240CL E7248CL E7356CL E7364CL	D7356C	H7356CA	F7356F	P7240F-A P7248F-A P7356F-A P7364F-A	MT01	MH41	UYX128GAS#10		
W131/FFT/CH /UTP(UTR)	240 248 356 364	M5240 M5248 M5356 M5364	E7240CL E7248CL E7356CL E7364CL	D7356C	H7356CA	F7356F	P7240F-A P7248F-A P7356F-A P7364F-A	MT01	MH41	UYX128GAS#10		
W132/FFT/CH	240 248 356 364	M5240 M5248 M5356 M5364	E7240CM E7248CM E7356CM E7364CM	D7356C	H7356CA	F7356F	P7240F-A P7248F-A P7356F-A P7364F-A	MT01	MH41	UYX128GAS#10		
W132/FFT/CH /UTP(UTR)	240 248 356 364	M5240 M5248 M5356 M5364	E7240CM E7248CM E7356CM E7364CM	D7356C	H7356CA	F7356F	P7240F-A P7248F-A P7356F-A P7364F-A	MT01	MH41	UYX128GAS#10		

SIRUBA GAGE PARTS LIST		Series			Remark						Page	Date
		C007KD			USE FOR FFT						3 / 4	2016/9/8
												
MODEL	SUB-CLASS	NEEDLE CLAMP	NEEDLE PLATE	MAIN FEED DOG	DIFF. FEED DOG	TOP FEED DOG	PRESSER FOOT	LOOPER	SPREADER	NEEDLE		
機 型	規 格	針 座	針 板	主送具	差送具	上送具	壓 具	勾 針	上 叉	使用針		
W811A/FFT/CRL	240 248 356 364	M5240 M5248 M5356 M5364	E5240NL E5248NL E5356NL E5364NL	D5356H	H5356NA	F7356L	P7240H-A P7248H-A P7356H-A P7364H-A	MT01	MH41	UYX128GAS#9		
U811A/FFT/CRL	240 248 356 364	M5240 M5248 M5356 M5364	E5240NL E5248NL E5356NL E5364NL	D5356H	H5356NA	F7356L	P7240L-A P7248L-A P7356L-A P7364L-A	MT01	—	UYX128GAS#9		
W811A/FFT/CRL /UTP(UTR)	240 248 356 364	M5240 M5248 M5356 M5364	E5240NL E5248NL E5356NL E5364NL	D5356H	H5356NA	F7356L	P7240H-A P7248H-A P7356H-A P7364H-A	MT01	MH41	UYX128GAS#9		
U811A/FFT/CRL /UTP(UTR)	240 248 356 364	M5240 M5248 M5356 M5364	E5240NL E5248NL E5356NL E5364NL	D5356H	H5356NA	F7356L	P7240L-A P7248L-A P7356L-A P7364L-A	MT01	—	UYX128GAS#9		
W812A/FFT/CRL	240 248 356 364	M5240 M5248 M5356 M5364	E5240NM E5248NM E5356NM E5364NM	D5356H	H5356NA	F7356L	P7240H-A P7248H-A P7356H-A P7364H-A	MT01	MH41	UYX128GAS#10		
U812A/FFT/CRL	240 248 356 364	M5240 M5248 M5356 M5364	E5240NM E5248NM E5356NM E5364NM	D5356H	H5356NA	F7356L	P7240L-A P7248L-A P7356L-A P7364L-A	MT01	—	UYX128GAS#10		
W812A/FFT/CRL /UTP(UTR)	240 248 356 364	M5240 M5248 M5356 M5364	E5240NM E5248NM E5356NM E5364NM	D5356H	H5356NA	F7356L	P7240H-A P7248H-A P7356H-A P7364H-A	MT01	MH41	UYX128GAS#10		

SIRUBA GAGE PARTS LIST		Series				Remark					Page	Date
		C007KD				USE FOR FFT					4 / 4	2016/8/22
												
MODEL	SUB-CLASS	NEEDLE CLAMP	NEEDLE PLATE	MAIN FEED DOG	DIFF. FEED DOG	TOP FEED DOG	PRESSER FOOT	LOOPER	SPREADER	NEEDLE		
機 型	規 格	針 座	針 板	主送具	差送具	上送具	壓 具	勾 針	上 叉	使用針		
U812A/FFT/CRL /UTP(UTR)	240 248 356 364	M5240 M5248 M5356 M5364	E5240NM E5248NM E5356NM E5364NM	D5356H	H5356NA	F7356L	P7240L-A P7248L-A P7356L-A P7364L-A	MT01	—	UYX128GAS#10		
W812A/FFT/CRL /CW/UTP(UTR)	456 460 464	M5456 M5460 M5464	E5456NM E5460NM E5464NM	D5356H	H5356NA	F7356L	P7456H-A P7460H-A P7464H-A	MT01	MH41	SM1014B#10 (MY1014B#70,SY7256)		

SIRUBA PARTS LIST	Series	Parts Group	Subclass / Remark	Page
	C007K/C007KD C858K	MF-K		1/1
				Date
				2016/8/31

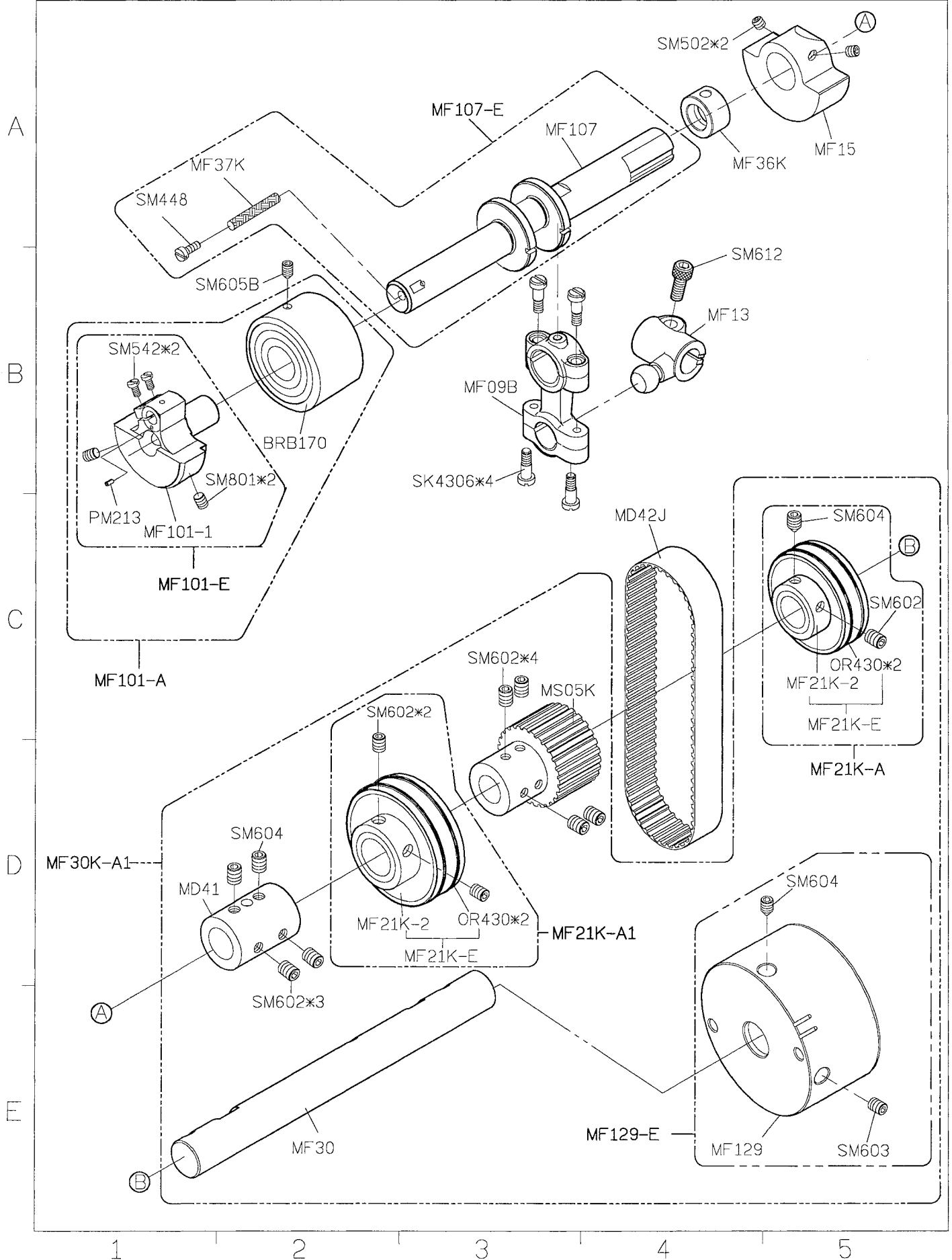

SIRUBA PARTS LIST	Series	Parts Group	Subclass / Remark	Page
	C007K/C007KD C858K	MG-K		1/1
				Date
				2016/9/6

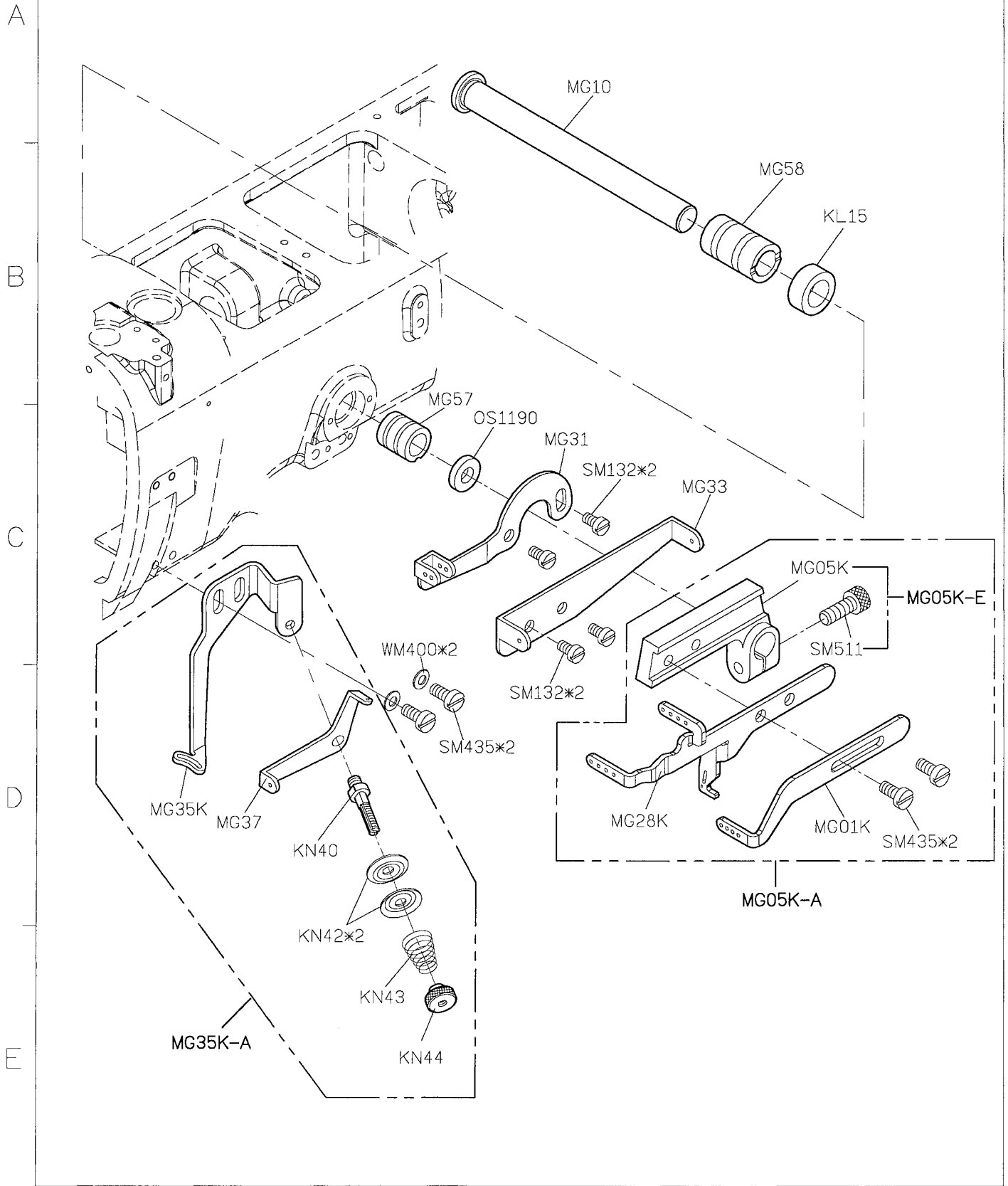

SIRUBA PARTS LIST	Series	Parts Group	Subclass / Remark	Page
	C007K/C007KD C858K	MH-K		1/1
				Date
				2016/9/6

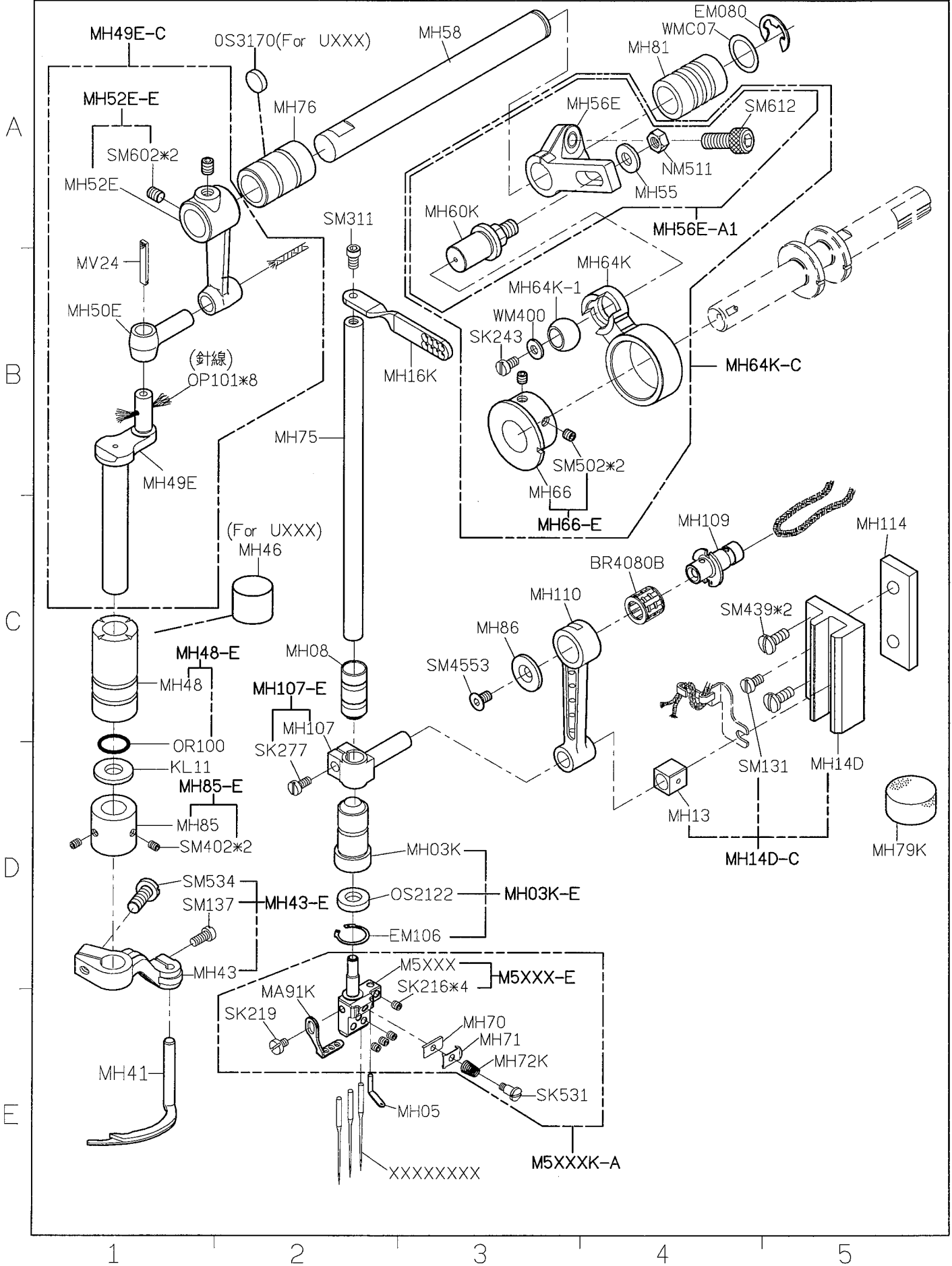

SIRUBA PARTS LIST	Series	Parts Group	Subclass / Remark	Page
	C007K/C007KD C858K	MJ-K		1/1
				Date
				2016/9/1

組件代號	零件內容
MJ35K-A1	MJ35K/MJ38/NM610 MJ54K/SM492
MJ35K-A3	MJ35K/MJ38/NM610

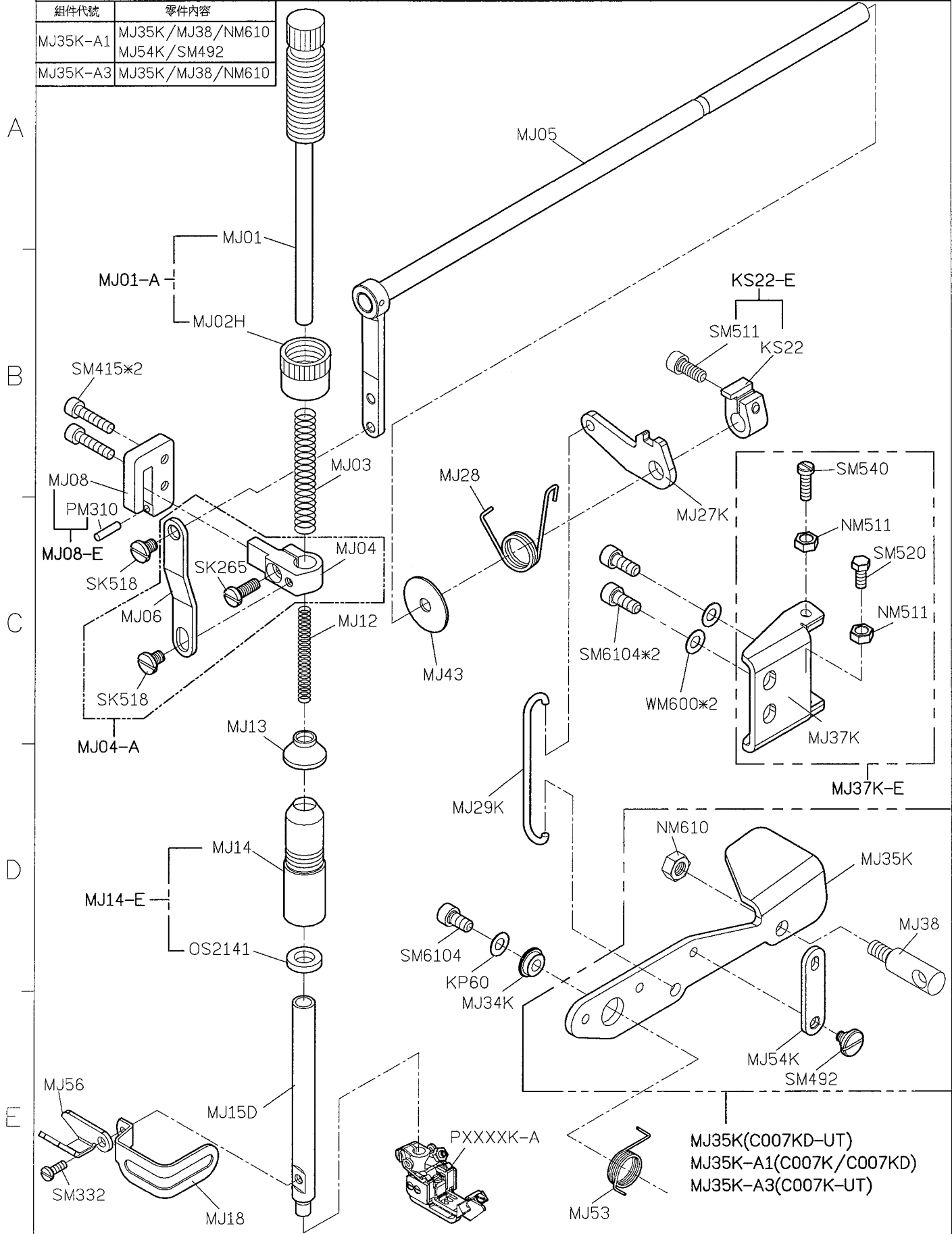

SIRUBA PARTS LIST	Series	Parts Group	Subclass / Remark	Page
	C007K/C007KD C858K	MK-K		1/1
				Date
				2016/8/29

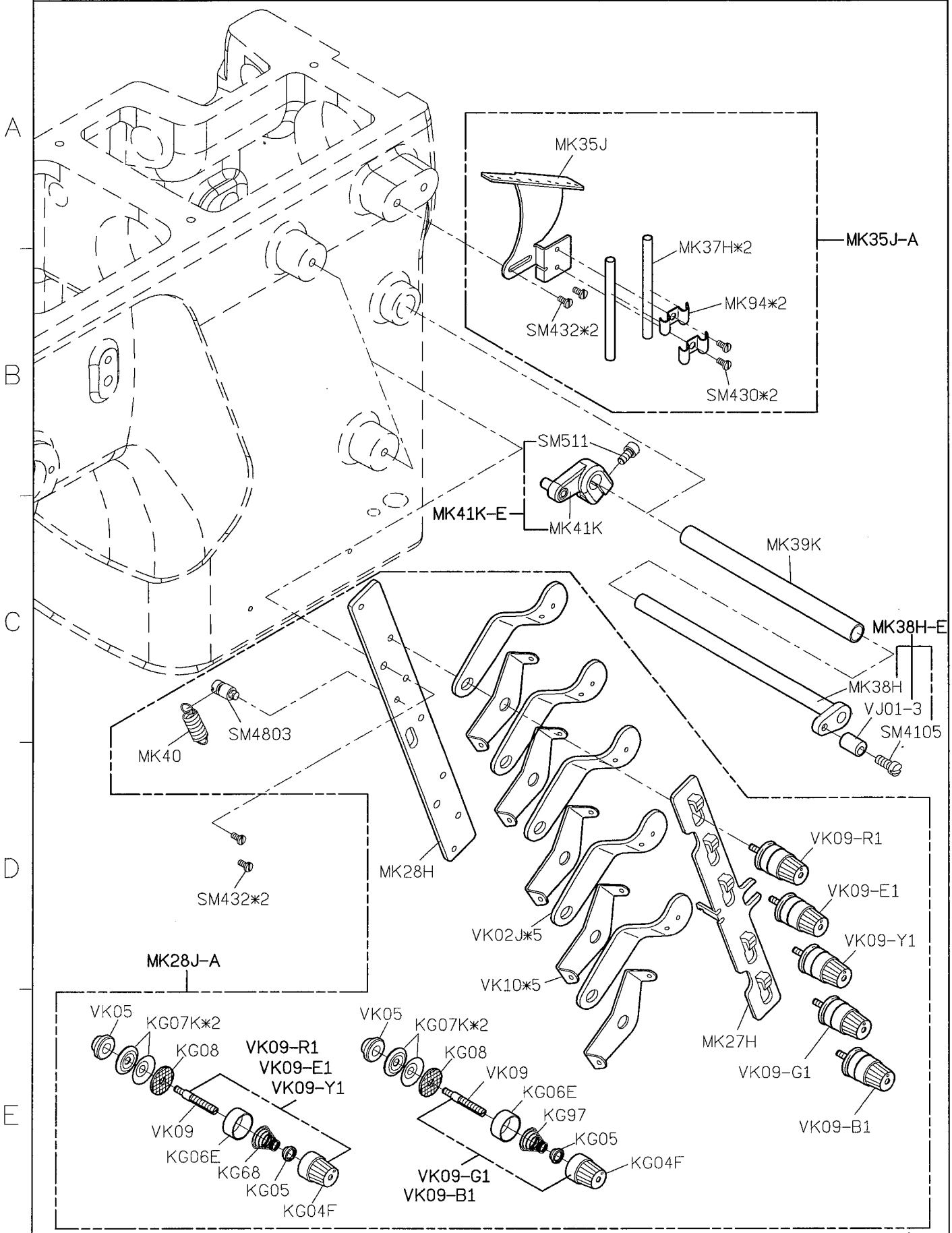

SIRUBA PARTS LIST	Series	Parts Group	Subclass / Remark	Page
	C007K/C007KD C858K	MN-K		1/2
				Date
				2016/8/29

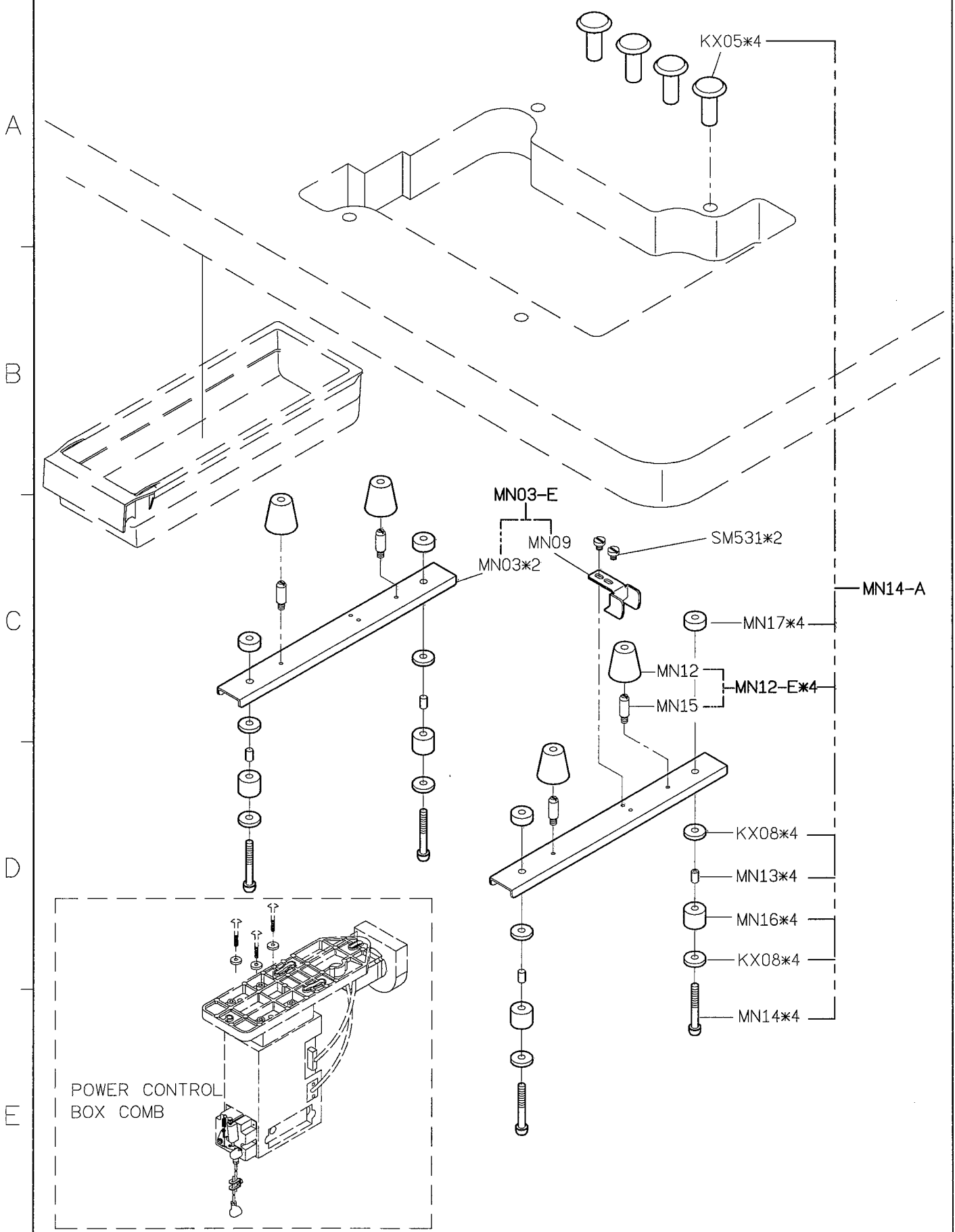

SIRUBA PARTS LIST	Series	Parts Group	Subclass / Remark	Page
	C007K/C007KD C858K	MN-K	# Use for C007K/C858K	2/2
				Date
				2016/8/29

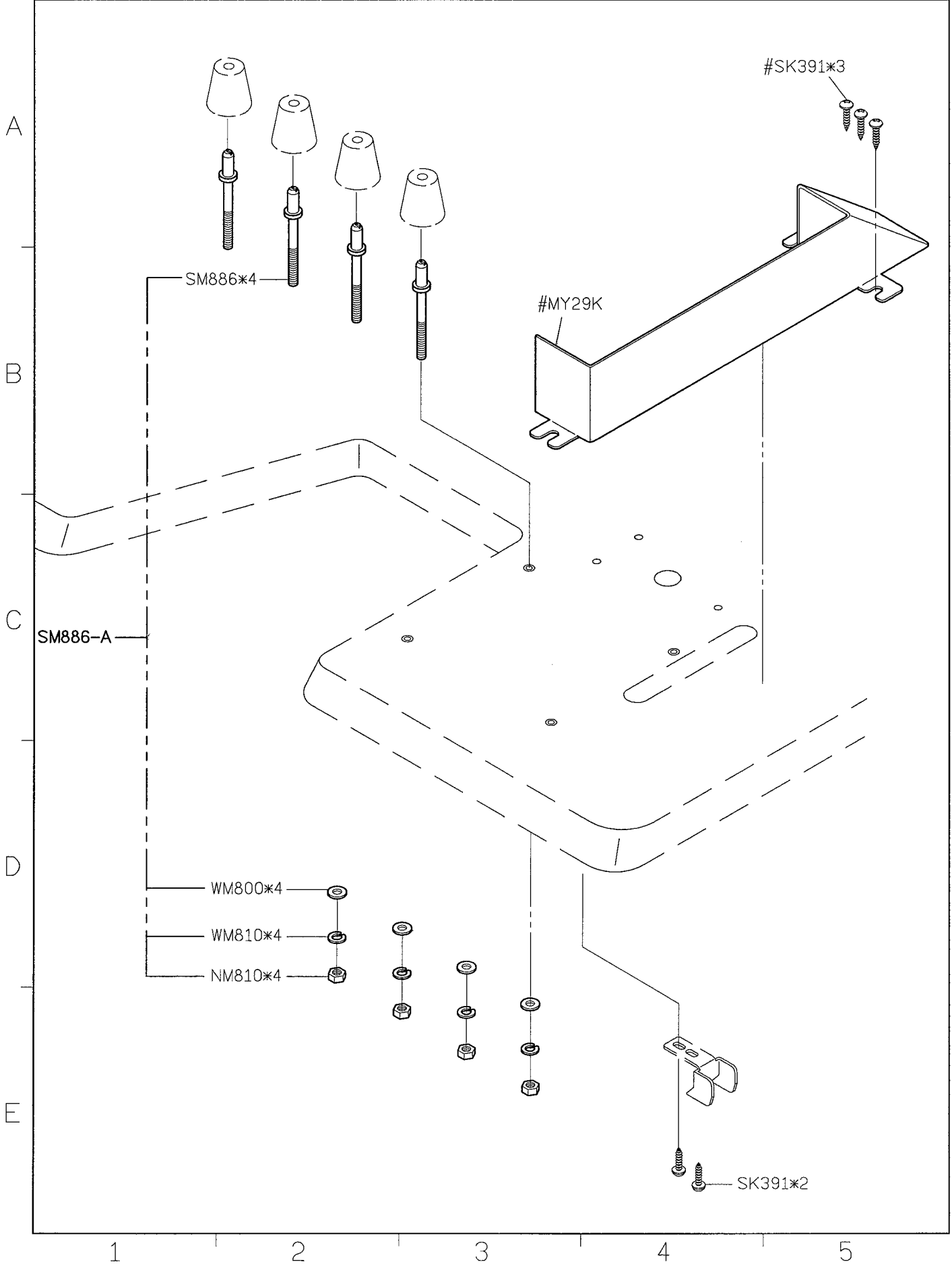

SIRUBA PARTS LIST	Series	Parts Group	Subclass / Remark	Page
	C007K/C007KD C858K	MQ-K		1/4
				Date
				2016/8/29

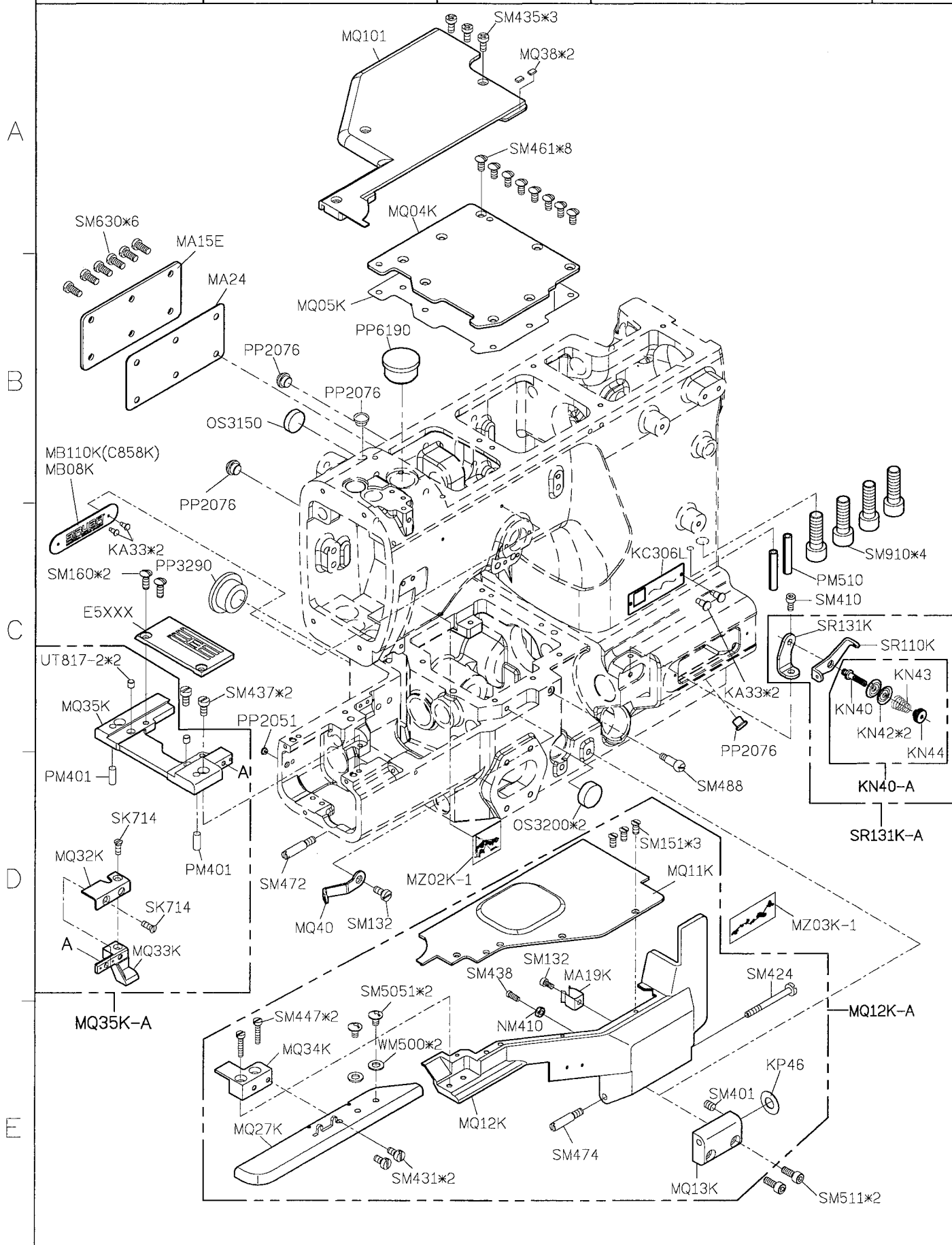

SIRUBA PARTS LIST	Series	Parts Group	Subclass / Remark	Page
	C007K/C007KD	MQ-K	For Direct-Drive Motor(H牌) #For Pneumatic Automatic %For Electric Automatic	2/4
				Date
				2016/8/29

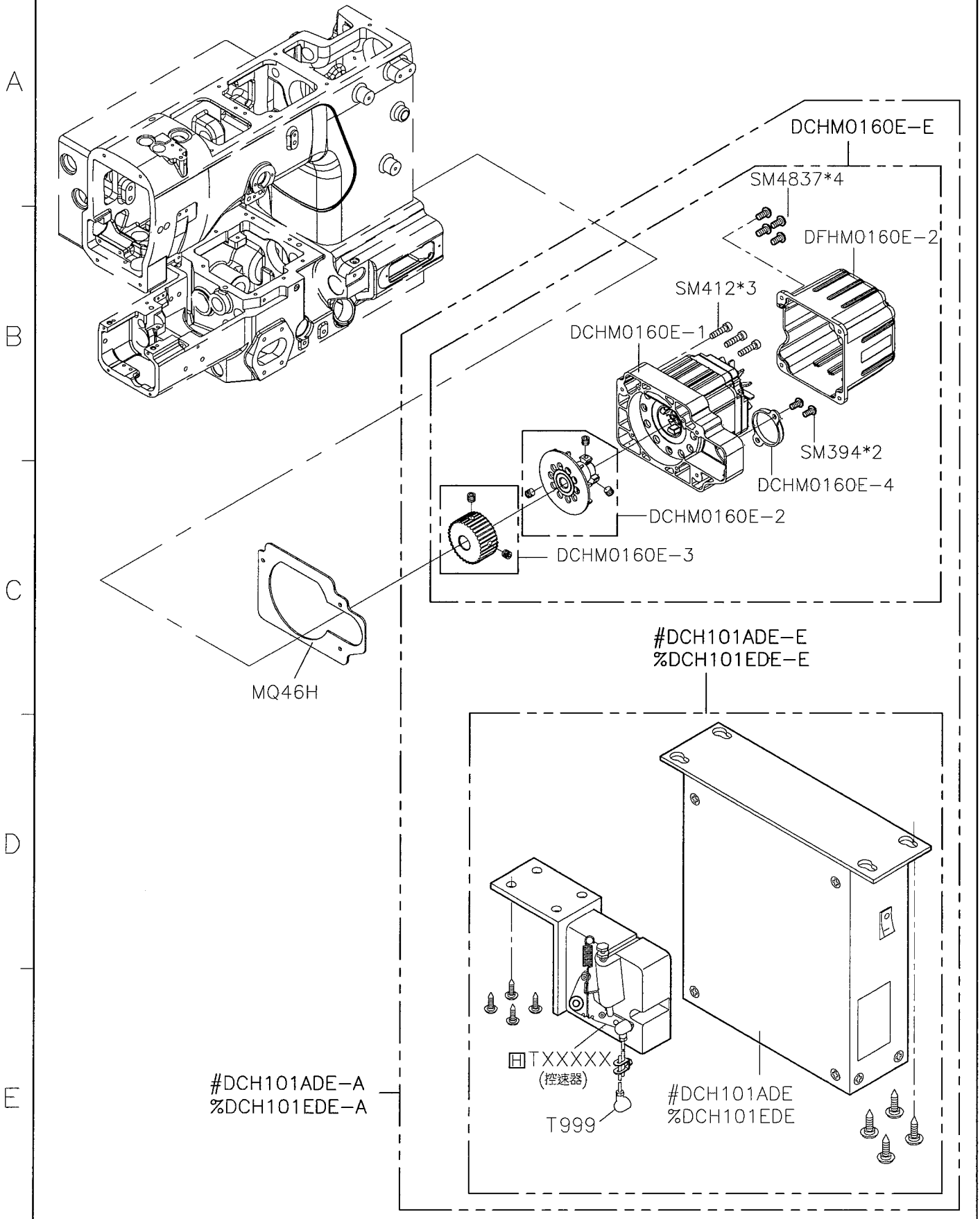

SIRUBA PARTS LIST	Series	Parts Group	Subclass / Remark	Page
	C007K/C007KD	MQ-K	For Direct-Drive Motor (T牌) #For Pneumatic Automatic %For Electric Automatic	3/4
				Date
				2016/8/29

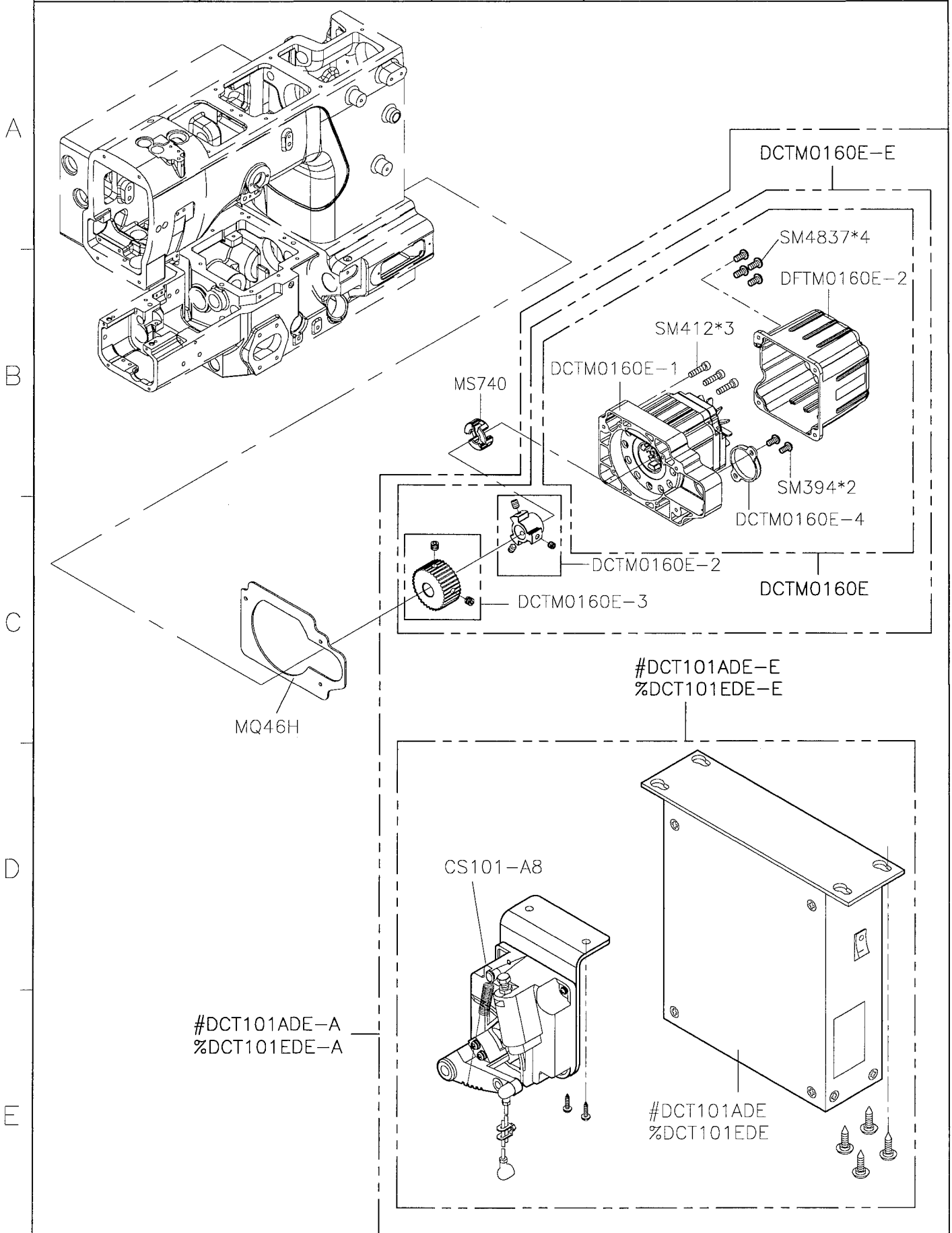

SIRUBA PARTS LIST	Series	Parts Group	Subclass / Remark	Page
	C007K/C007KD	MQ-K	For Direct-Drive Motor(P牌) #For Pneumatic Automatic %For Electric Automatic	4/4
				Date
				2016/8/29

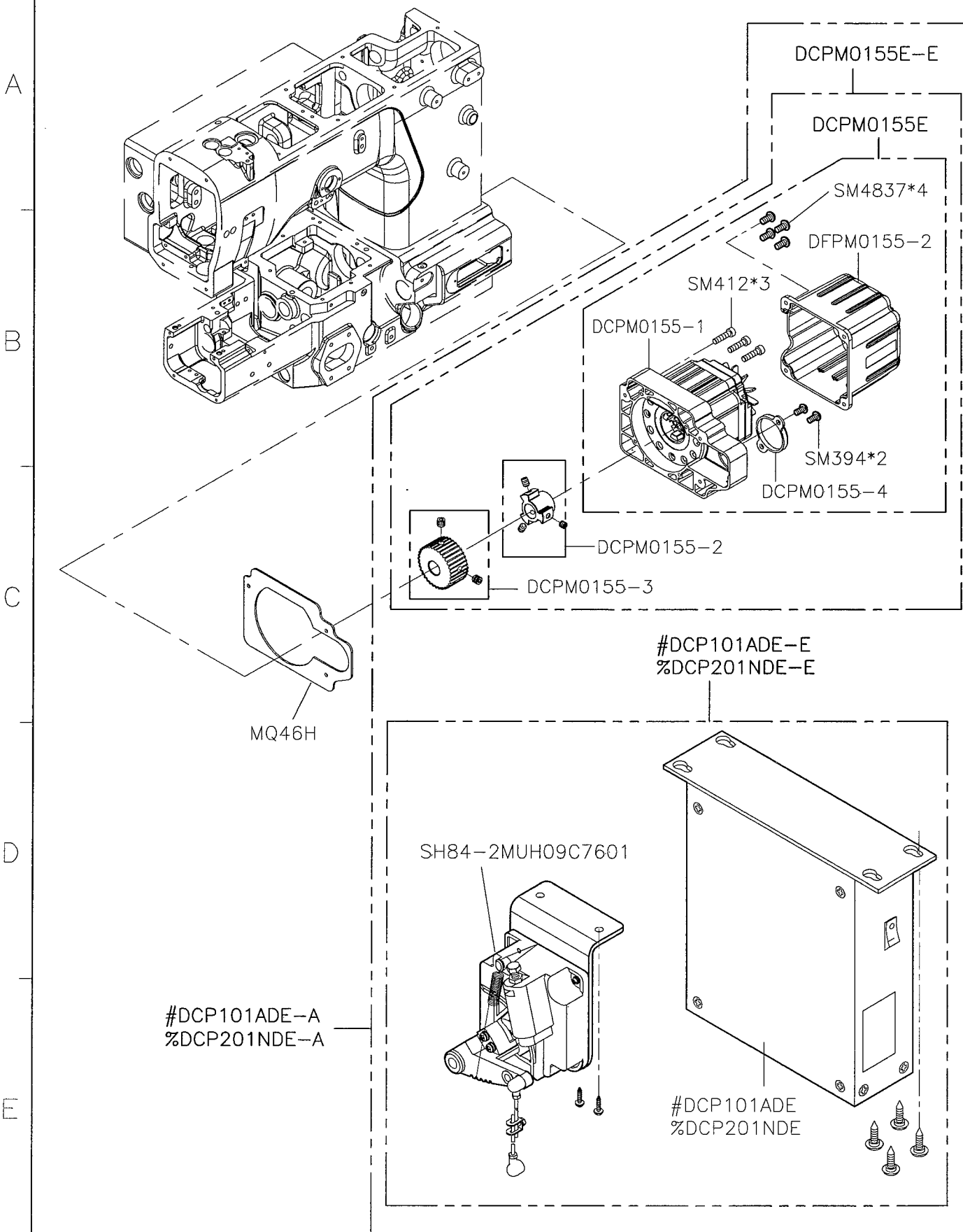

1 2 3 4 5

SIRUBA PARTS LIST	Series	Parts Group	Subclass / Remark	Page
	C007K/C007KD C858K	MR-K	△ : Use for CW #: Use for C007K/C858K	1/1
				Date
				2016/8/29

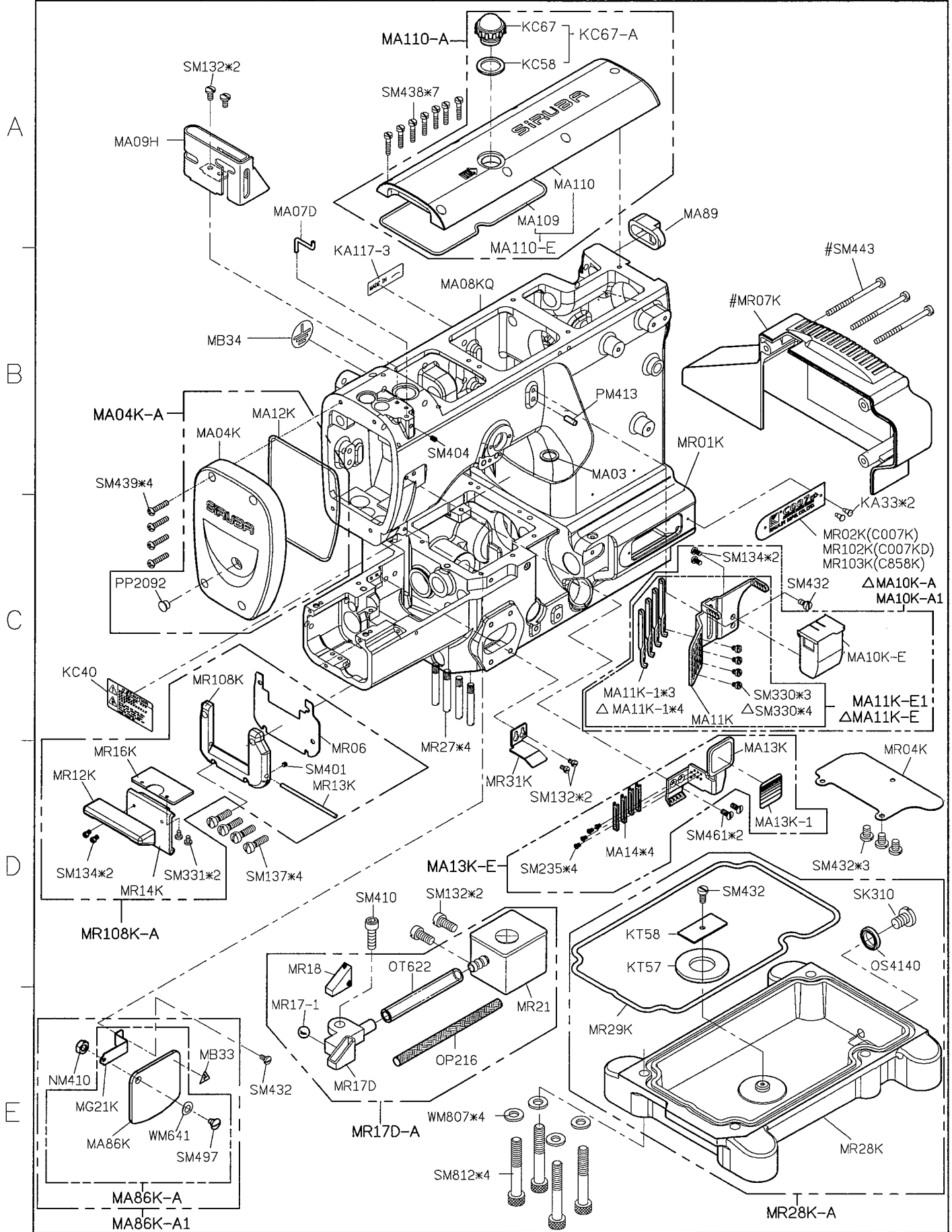

SIRUBA PARTS LIST	Series	Parts Group	Subclass / Remark	Page
	C007K/C007KD C858K	MS-K	#: Use for C007K/C858K	1/1
				Date
				2016/8/30

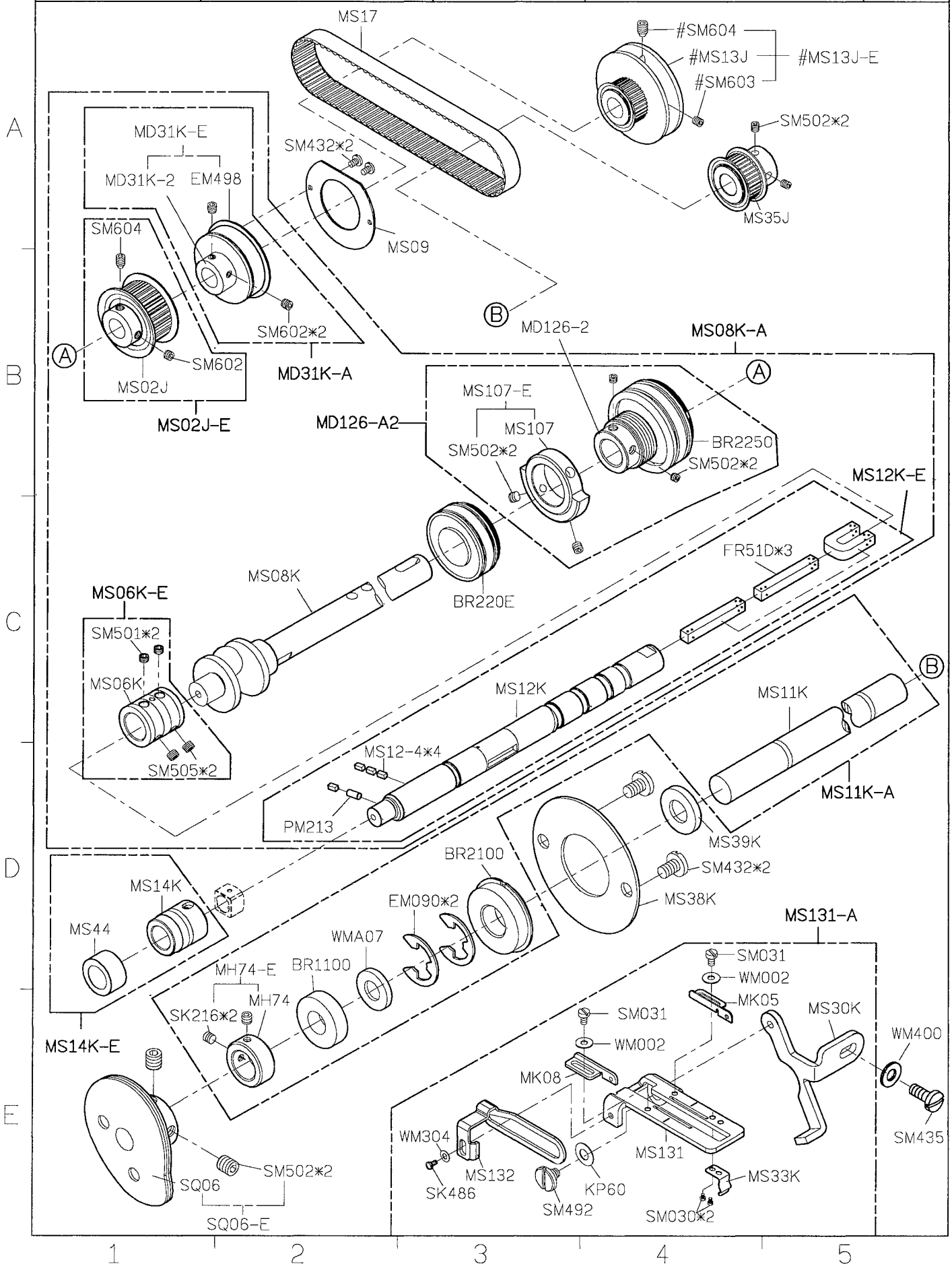

SIRUBA PARTS LIST	Series	Parts Group	Subclass / Remark	Page
	C007K/C007KD C858K	MT-K		1/1
				Date
				2016/8/30

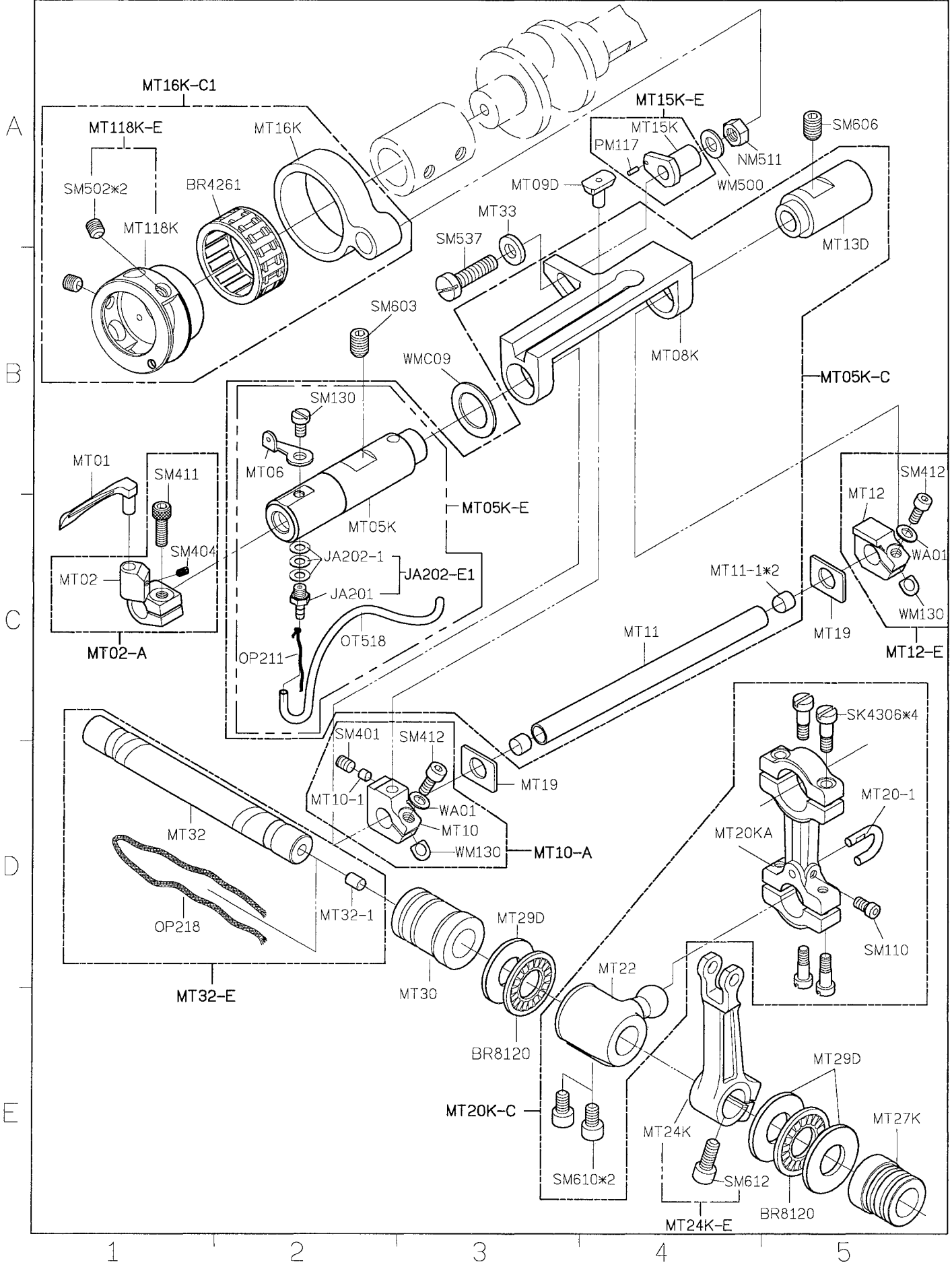

SIRUBA PARTS LIST	Series	Parts Group	Subclass / Remark	Page
	C007K/C007KD C858K	MU-K	# : Use for CRL	1/1
				Date
				2016/8/30

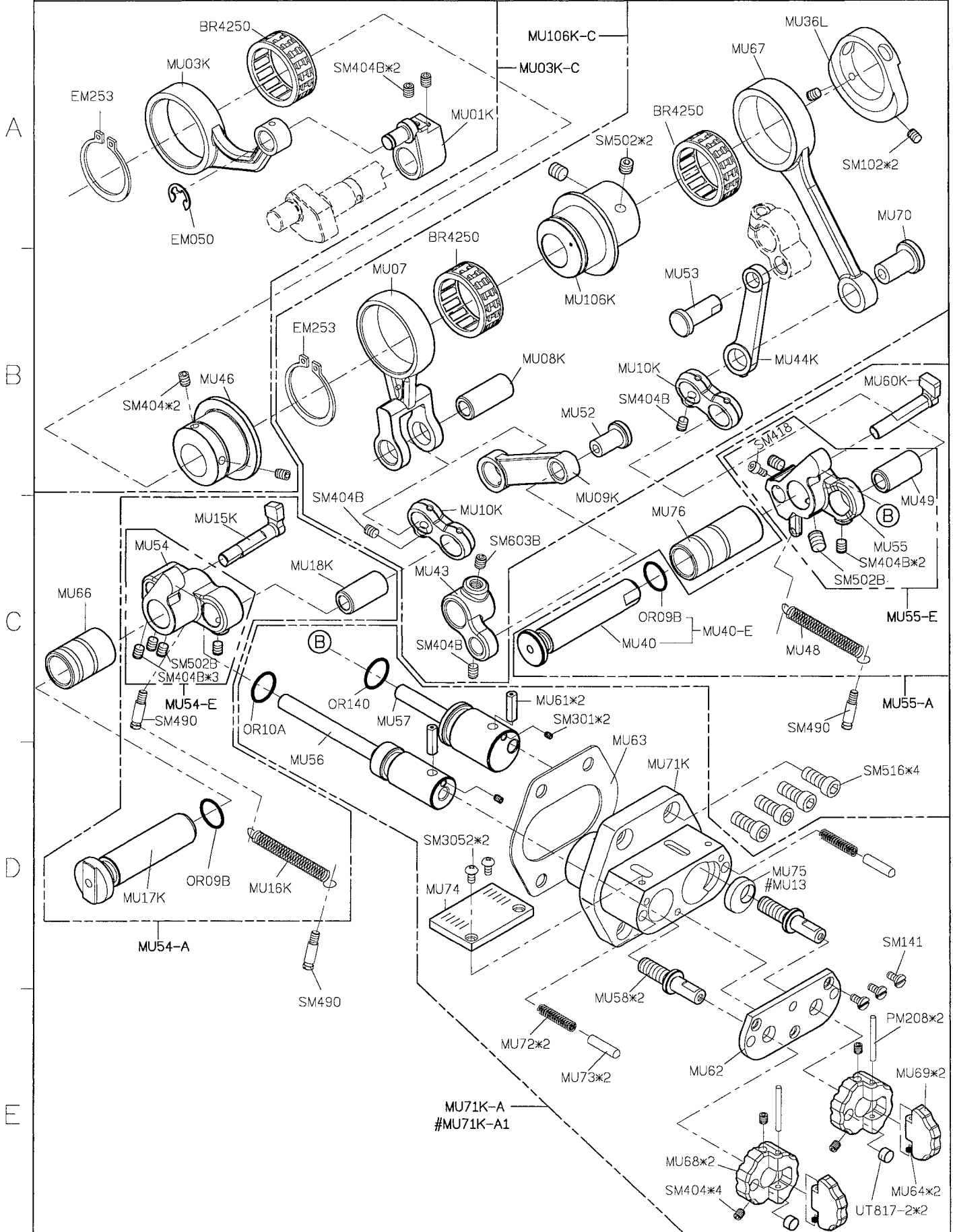

1 2 3 4 5

SIRUBA PARTS LIST	Series	Parts Group	Subclass / Remark	Page
	C007K/C007KD C858K	MV-K		1/1
				Date
				2016/8/30

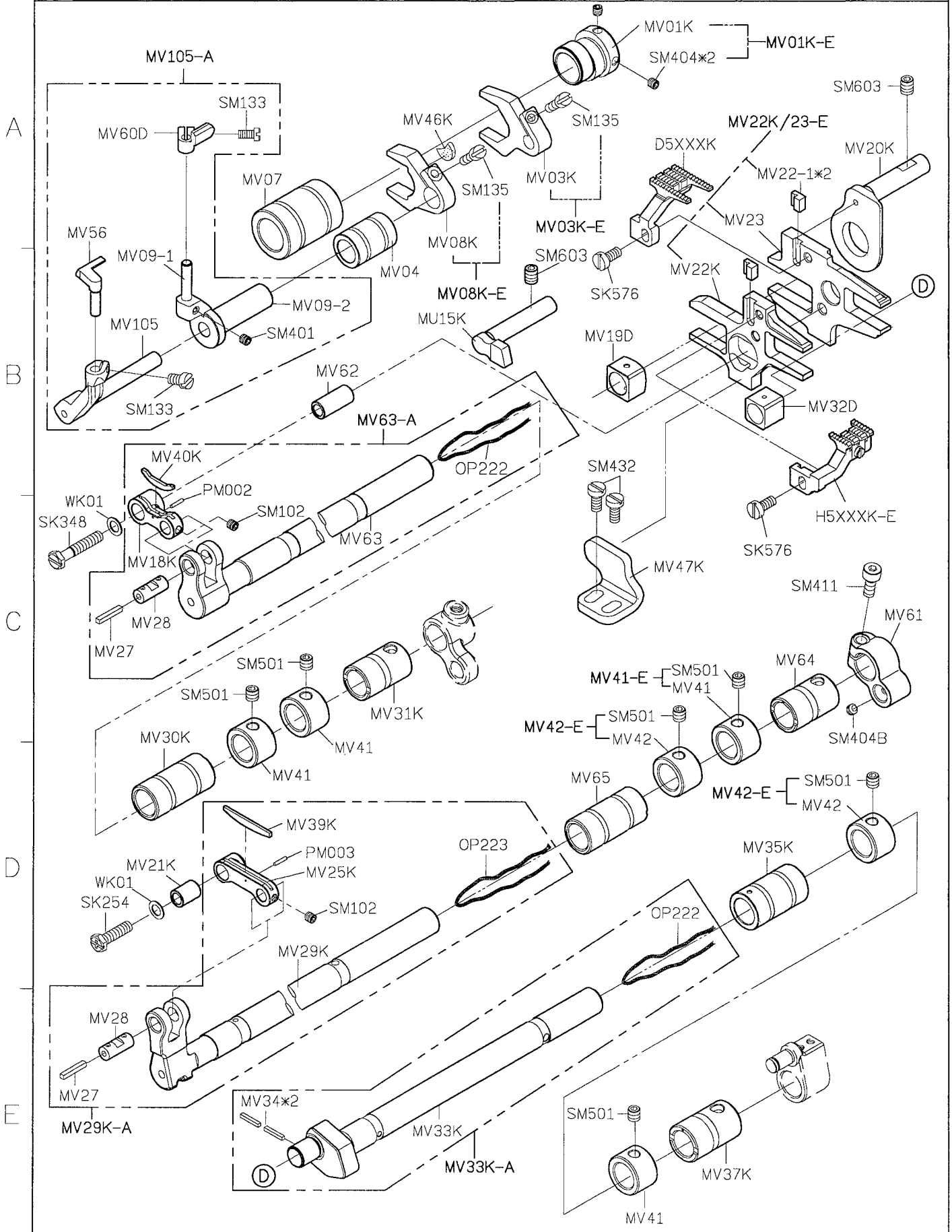

1 2 3 4 5

SIRUBA PARTS LIST	Series	Parts Group	Subclass / Remark	Page
	C007K/C007KD	MW-K		1/1
	C858K			Date
				2016/8/30

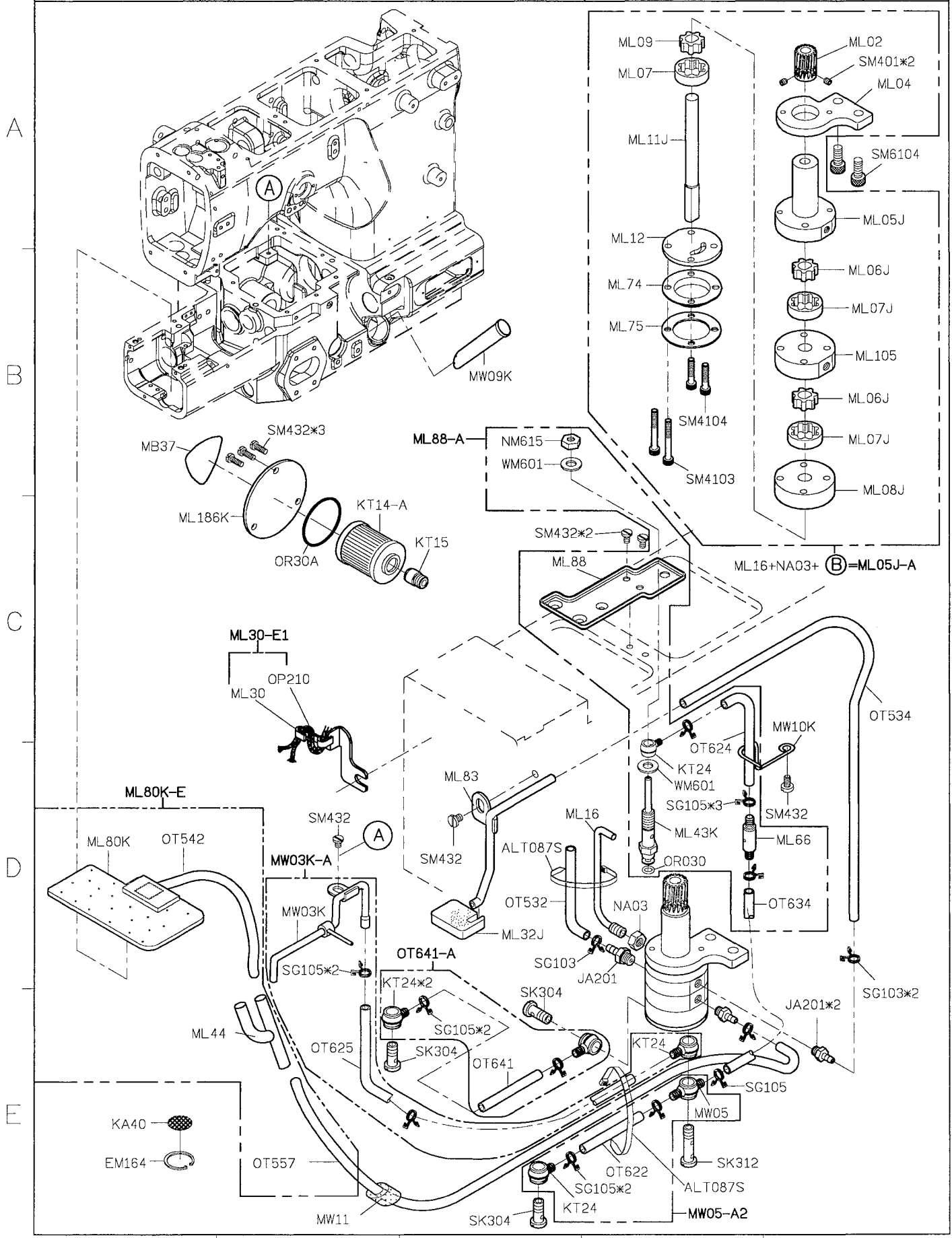

SIRUBA PARTS LIST	Series	Parts Group	Subclass / Remark	Page
	C007K/C007KD C858K	MY-K		1/1
				Date
				2016/8/30

A

MY01 KY03 KY04 KY05-A KY23-A KY23(6/7mm) KY09

B

MY10-A MY09 KY10 MY10 MY11 MY12 KY11 KY14 LY33-A LY33 LY34 KY18

C

KY20D-A 針*5 MY21-E KY21-1 MY21 KY201 KZ03

D

KT14-A MY29K(C007K/C858K) SM886-A(C007K/C858K) SM886-A1(C007KD)

SM886*4	WM800*4
WM810*4	NM810*4
SK391*5	

SM886*4	WM800*4
WM810*4	NM810*4
SK391*2	

E

MY127K Instruction book (使用説明書)

MY32K Parts list (零件圖)

Parts list	
Basic mechanism	MY32K
Special mechanism	MY32K
UTP/UTQ	MY32K UT120K
Special machine type + UTP/UTQ	MY32K UT120K
UTR/UTS	MY32K UT240K
Special machine type + UTR/UTS	MY32K UT240K

SIRUBA PARTS LIST	Series	Parts Group	Subclass / Remark	Page
	C007K/C007KD C858K	MZ-K		1/2
				Date
				2016/8/29

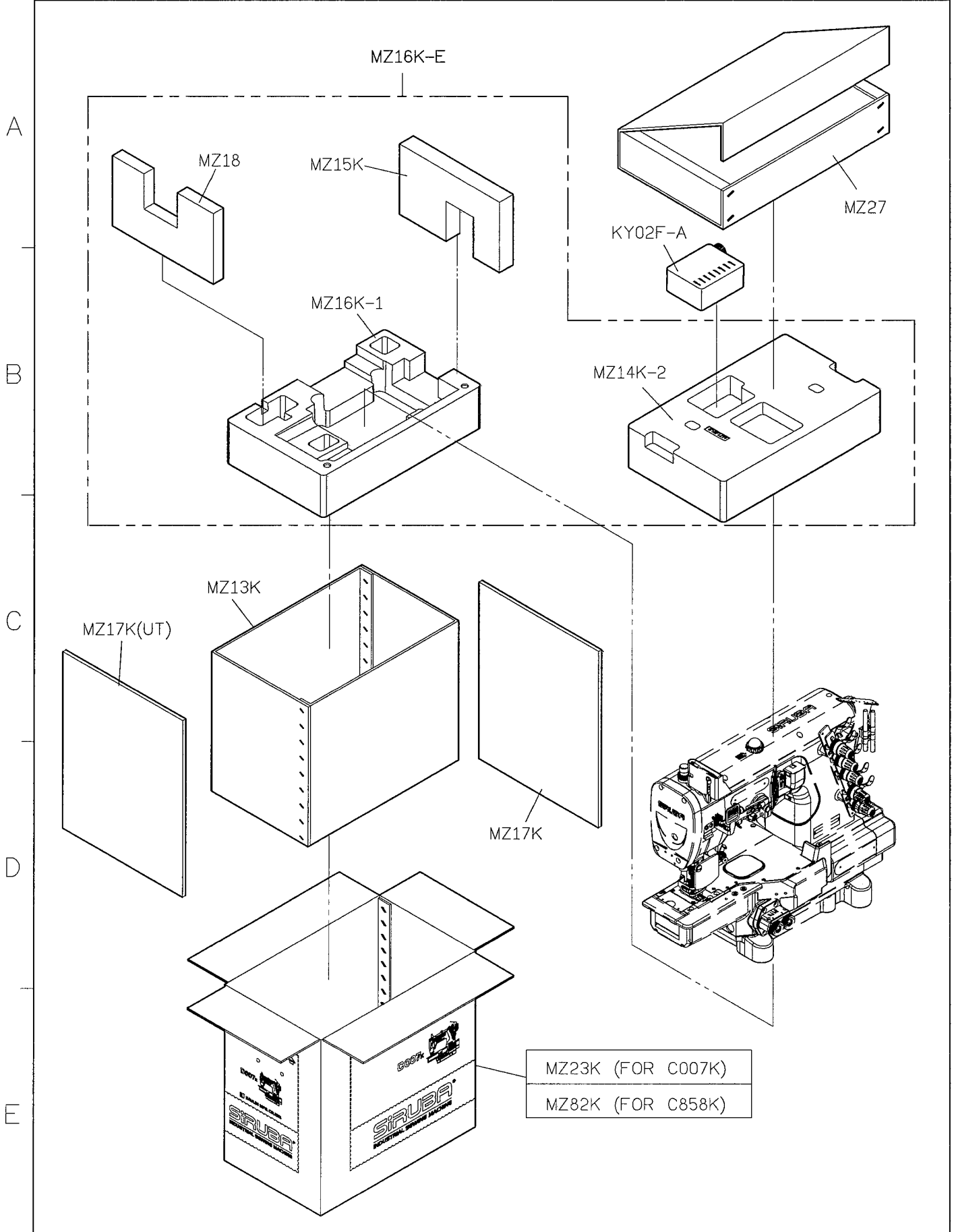

1 2 3 4 5

SIRUBA PARTS LIST	Series	Parts Group	Subclass / Remark	Page
	C007K/C007KD C858K	MZ-K	For C007KD	2/2
				Date
				2016/8/29

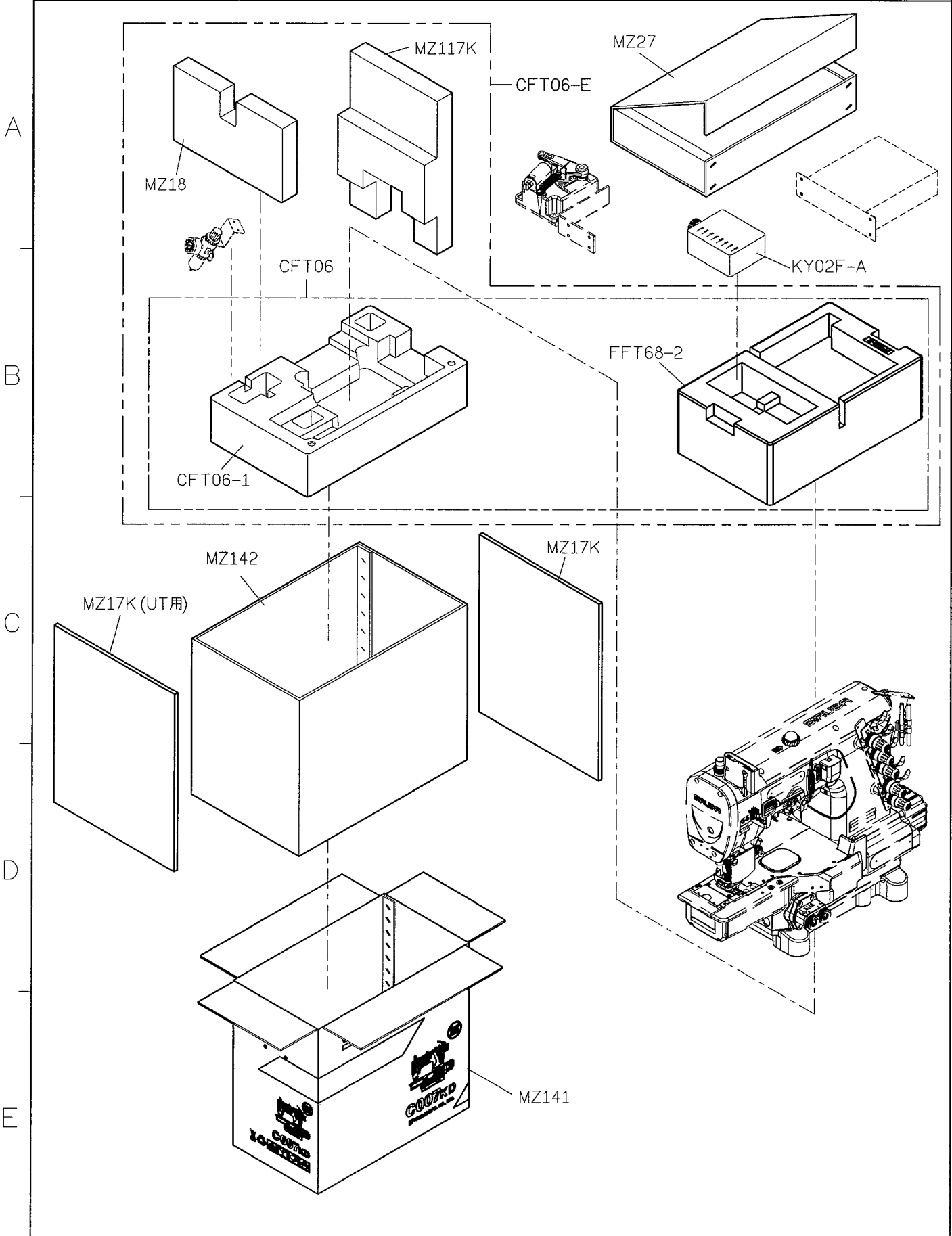

SIRUBA TABLE CUT - OUT	Series	Item Code	Subclass / Remark	Mounting
	C007K/C007KD C858K/C858KD S007K/S007KD	C007K-T23	For All Series	Semi-submerged
				Date 2013/01/28

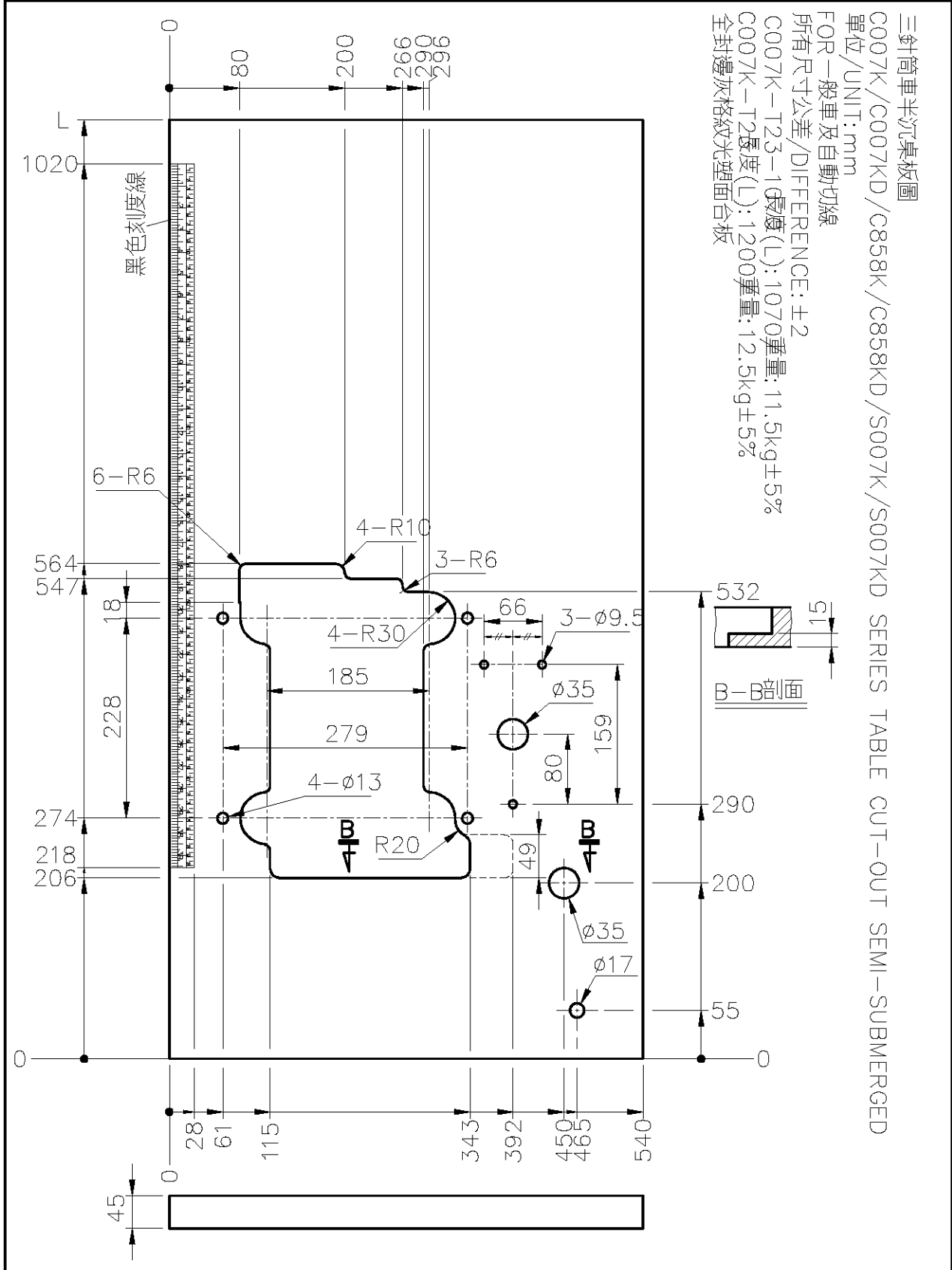

SIRUBA TABLE CUT - OUT	Series	Item Code	Subclass / Remark	Mounting
	C007K/C858K	C007K-T26	For CFC	Semi-submerged
				Date
				2015/11/27

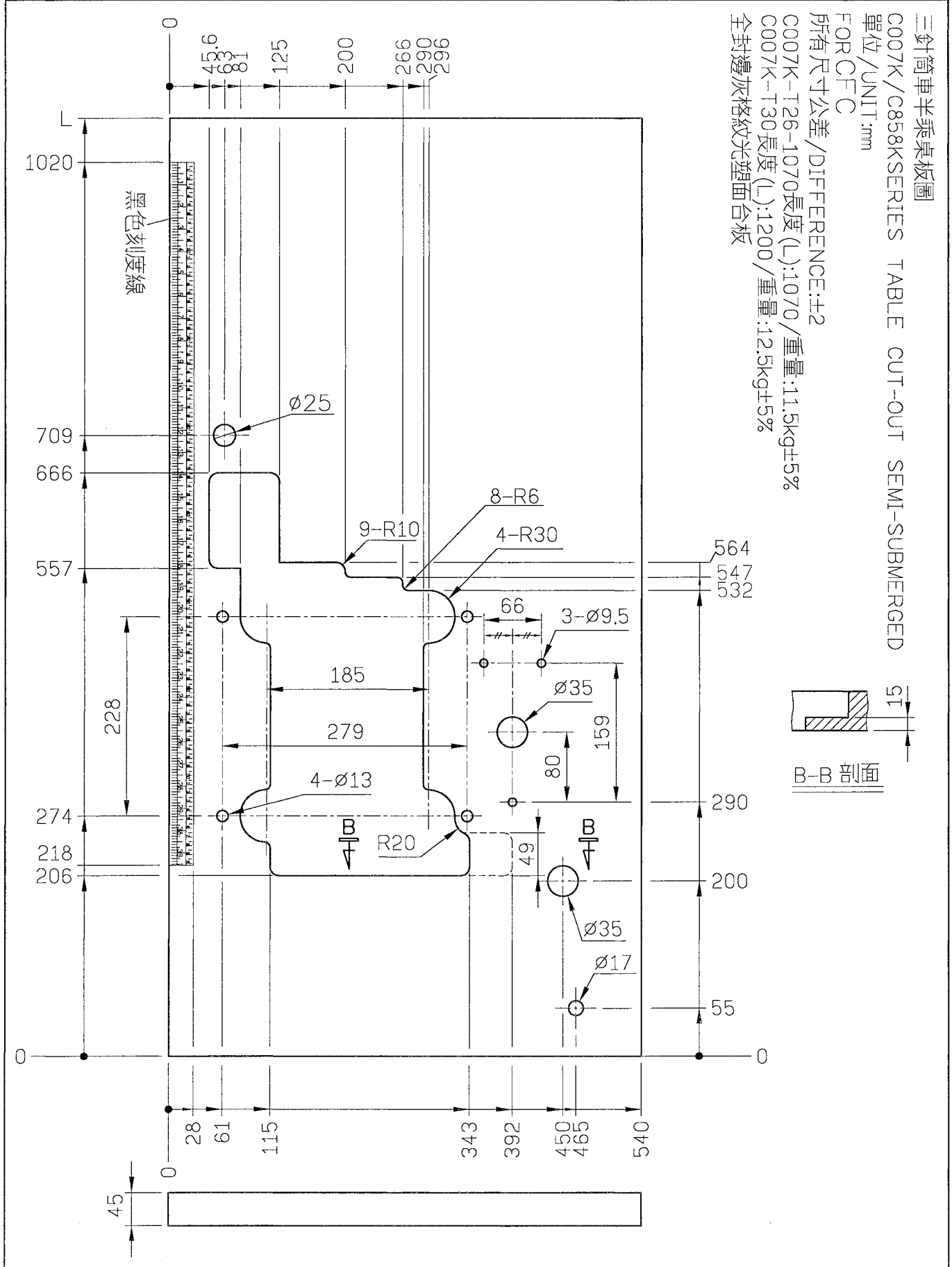

SIRUBA TABLE CUT - OUT	Series	Item Code	Subclass / Remark	Mounting
	C007J/C007K	C007-T30		Non-submerged
				Date
				2016/10/03

三針筒車上乘桌板圖
 C007J/C007K SERIES TABLE CUT-OUT SEMI-SUBMERGED
 單位/UNIT:mm
 FOR 印度客戶使用
 所有尺寸公差/DIFFERENCE:±2
 C007-T30-1070長度(L):1070/重量:11.3kg±5%
 C007-T30長度(L):1200/重量:12.3kg±5%
 全封邊灰格紋光塑面台板

