

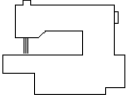



筒車直驅伺服馬達規格件表 / CONVERSION CHART

P1

										
MODEL	SUB-CLASS	NEEDLE CLAMP	NEEDLE PLATE	MAIN FEED DOG	DIFF. FEED DOG	PRESSER FOOT	SPREADER	LOOPER	NEEDLE	Motor
機 型	規 格	針 座	針 板	主 送 具	差 送 具	押 具	上 叉	勾 針	針 號	馬 達
C007JD C858JD /CH	356 364	M5356 M5364	E 3816P E 3817P	D 4206 D 4207	H 4458 H 4459	P2446-A P2447-A	MH41	MT01	UYX128GAS #10	T501HE
C007JD C858JD /CH	356 364	M5356 M5364	E 3816P E 3817P	D 4206 D 4207	H 4458 H 4459	P2446-A P2447-A	—	MT01	UYX128GAS #10	
C007JD C858JD CH/UTP(UTR)	356 364	M5356 M5364	E 3816P E 3817P	D 4206 D 4207	H 4458 H 4459	P2446-A P2447-A	MH41	MT01	UYX128GAS #10	
C007JD C858JD CH/UTQ(UTS)	356 364	M5356 M5364	E 3816P E 3817P	D 4206 D 4207	H 4458 H 4459	P2446-A P2447-A	—	MT01	UYX128GAS #10	
C007JD C858JD /CH	240 248 256 356 364	M5240 M5248 M5356 M5356 M5364	E 3524P E3525P E 3826S E 3826P E 3827P	D4206 D4206 D4206 D4206 D4207	H 4458 H 4458 H 4458 H 4458 H 4459	P2544-A P2545-A P2446-A P2446-A P2447-A	MH41	MT01	UYX128GAS #10	
C007JD C858JD /CH	240 248 256 356 364	M5240 M5248 M5356 M5356 M5364	E 3524P E3525P E 3826S E 3826P E 3827P	D4206 D4206 D4206 D4206 D4207	H 4458 H 4458 H 4458 H 4458 H 4459	P2544-A P2545-A P2446-A P2446-A P2447-A	—	MT01	UYX128GAS #10	
C007JD C858JD CH/UTP(UTR)	240 248 256 356 364	M5240 M5248 M5356 M5356 M5364	E 3524P E3525P E 3826S E 3826P E 3827P	D4206 D4206 D4206 D4206 D4207	H 4458 H 4458 H 4458 H 4458 H 4459	P2544-A P2545-A P2446-A P2446-A P2447-A	MH41	MT01	UYX128GAS #10	

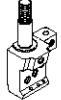
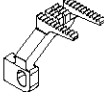
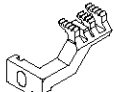
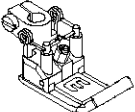
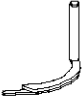
註：P2544-A/P2545-A為固定式押具舌,亦可使用活動式押具舌 P2565-A代替P2544-A/P2545-A

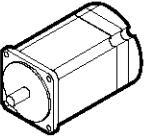



P2544-A/P2545-A is the fixed presser foot tongue. It can be replaced by the removable presser foot tongue P2565-A.

P2446-A/P2447-A為固定式押具舌,亦可使用活動式押具舌 P2466-A代替P2446-A/P2447-A

P2446-A/P2447-A is the fixed presser tongue. It can be replaced by the removable presser foot tongue P2466-A.

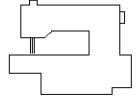
筒車直驅伺服馬達規格件表/CONVERSION CHART

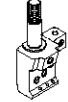
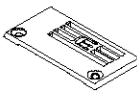
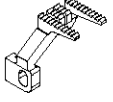
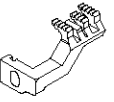
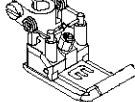
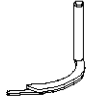
P2

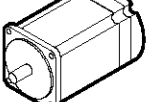
										
MODEL	SUB-CLASS	NEEDLE CLAMP	NEEDLE PLATE	MAIN FEED DOG	DIFF. FEED DOG	PRESSER FOOT	SPREADER	LOOPER	NEEDLE	Motor
機 型	規 格	針 座	針 板	主 送 具	差 送 具	押 具	上 叉	勾 針	針 號	馬 達
C007JD C858JD CH/UTQ(UTS)	240	M5240	E 3524P	D4206	H4458	P2544-A	—	MT01	UYX128GAS #10	☐ T501HE
	248	M5248	E3525P	D4206	H4458	P2545-A				
	256	M5356	E 3826S	D4206	H4458	P2446-A				
	356	M5356	E 3826P	D4206	H4458	P2446-A				
364	M5364	E 3827P	D4207	H4459	P2447-A					
C007JD C858JD /CHA	356	M5356	E 3826Q	D4206	H4458	P0216-A	MH41	MT01	UYX128GAS #10	
C007JD C858JD /CHA	356	M5356	E 3826Q	D4206	H4458	P0416-A	—	MT01	UYX128GAS #10	
C007JD C858JD /CH	240	M5240	E 3534P	D4206	H4458	P2544-A	MH41	MT01	UYX128GAS #10	
	248	M5248	E3535P	D4206	H4458	P2545-A				
	356	M5356	E 3836P	D4206	H4458	P2446-A				
	364	M5364	E 3837P	D4207	H4459	P2447-A				
C007JD C858JD /CH	240	M5240	E 3534P	D4206	H4458	P2544-A	—	MT01	UYX128GAS #10	
	248	M5248	E3535P	D4206	H4458	P2545-A				
	356	M5356	E 3836P	D4206	H4458	P2446-A				
	364	M5364	E 3837P	D4207	H4459	P2447-A				
C007JD C858JD /CHE	240	M5240	E2324P	D2109	H2219	P2904-A	MH41	MT01	UYX128GAS #10	
	248	M5248	E2325P	D2109	H2219	P2905-A				
	356	M5356	E 2326P	D2110	H2220	P2906-A				
	364	M5364	E2327P	D2110	H2220	P2907-A				
C007JD C858JD CHE/UTP(UTR)	356	M5356	E 2326P	D2110	H2220	P2906-A	MH41	MT01	UYX128GAS #10	
	364	M5364	E2327P			P2907-A				







註：P2544-A/P2545-A為固定式押具舌,亦可使用活動式押具舌 P2565-A代替P2544-A/P2545-A

P2544-A/P2545-A is the fixed presser foot tongue. It can be replaced by the removable presser foot tongue P2565-A.

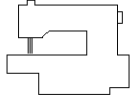
P2446-A/P2447-A為固定式押具舌,亦可使用活動式押具舌 P2466-A代替P2446-A/P2447-A

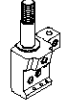
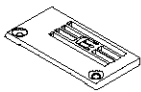
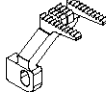
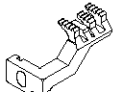
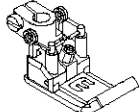
P2446-A/P2447-A is the fixed presser foot tongue. It can be replaced by the removable presser foot tongue P2466-A.

筒車直驅伺服馬達規格件表/CONVERSION CHART

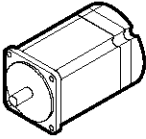
										
MODEL	SUB-CLASS	NEEDLE CLAMP	NEEDLE PLATE	MAIN FEED DOG	DIFF. FEED DOG	PRESSER FOOT	SPREADER	LOOPER	NEEDLE	Motor
機型	規格	針座	針板	主送具	差送具	押具	上叉	勾針	針號	馬達
C007JD C858JD-W152 /CZP/RLQ	356 364	M5356 M5364	E4326 E4327	D3216 D3217	H3262 H3263	P2416-A P2417-A	MH41	MT01	UYX128GAS #10	☐ T501HE
C007JD C858JD-U152 /CZP/RLQ	356 364	M5356 M5364	E4326 E4327	D3216 D3217	H3262 H3263	P2416-A P2417-A	—	MT01	UYX128GAS #10	
C007JD C858JD-W152 CZP/CLA/RLQ	356 364	M5356 M5364	E4326 E4327	D3216 D3217	H3262 H3263	P2416-A P2417-A	MH41	MT01	UYX128GAS #10	
C007JD C858JD-U152 CZP/CLA/RLQ	356 364	M5356 M5364	E4326 E4327	D3216 D3217	H3262 H3263	P2416-A P2417-A	—	MT01	UYX128GAS #10	
C007JD C858JD-W162	240 248 356 364	M5240 M5248 M5356 M5364	E3544 E3545 E3846 E3847	D4206 D4206 D4206 D4207	H4458 H4458 H4458 H4459	P2544-A P2545-A P2446-A P2447-A	MH41	MT01A	TVX5 #14~16	
C007JD C858JD-U162	240 248 356 364	M5240 M5248 M5356 M5356	E3544 E3545 E3846 E3847	D4206 D4206 D4206 D4207	H4458 H4458 H4458 H4459	P2544-A P2545-A P2446-A P2447-A	—	MT01A	TVX5 #14~16	
C007JD C858JD-W162 /UTP (UTR)	240 248 356 364	M5240 M5248 M5356 M5364	E3544 E3545 E3846 E3847	D4206 D4206 D4206 D4207	H4458 H4458 H4458 H4459	P2544-A P2545-A P2446-A P2447-A	MH41	MT01A	TVX5 #14~16	
C007JD C858JD-U162 /UTQ (UTS)	240 248 356 364	M5240 M5248 M5356 M5356	E3544 E3545 E3846 E3847	D4206 D4206 D4206 D4207	H4458 H4458 H4458 H4459	P2544-A P2545-A P2446-A P2447-A	—	MT01A	TVX5 #14~16	







註：P2544-A/P2545-A為固定式押具舌,亦可使用活動式押具舌 P2565-A代替 P2544-A/P2545-A

P2544-A/P2545-A is the fixed presser foot tongue. It can be replaced by the removable presser foot tongue P2565-A.

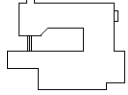
P2446-A/P2447-A為固定式押具舌,亦可使用活動式押具舌 P2466-A代替 P2446-A/P2447-A

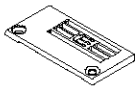
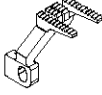
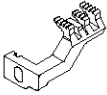
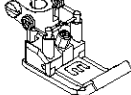
P2446-A/P2447-A is the fixed presser foot tongue. It can be replaced by the removable presser foot tongue P2466-A.

筒車直驅伺服馬達規格件表 / CONVERSION CHART

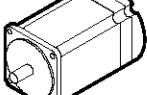
										
MODEL	SUB-CLASS	NEEDLE CLAMP	NEEDLE PLATE	MAIN FEED DOG	DIFF. FEED DOG	PRESSER FOOT	SPREADER	LOOPER	NEEDLE	Motor
機 型	規 格	針 座	針 板	主送具	差送具	押 具	上 叉	勾 針	針 號	馬 達
C007JD C858JD -W222 /CQ	240	M5240	E4124P	D3216	H3362	P1814-A	MH41	MT01	UYX128GAS #10	T501HE
C007JD C858JD -U222 /CQ	248 356 364	M5248 M5356 M5364	E4125P E4426P E4427P	D3216 D3216 D3217	H3362 H3362 H3363	P1815-A P2116-A P2117-A				
C007JD C858JD - /CQA/CLA	256	M5356	E2326Q	D2110	H2220Q	P2906Q-A	MH41	MT01A	TVX5 #14	
C007JD C858JD -W322 /CC	356 364	M5356 M5364	E2826P E2827P	D2107L D2107L	H3259M H3259M	P2456-A P2457-A	MH41	MT01	UYX128GAS #10	
C007JD C858JD -U322 /CC	356 364	M5356 M5364	E2826P E2827P	D2107L D2107L	H3259M H3259M	P2456-A P2457-A	—	MT01	UYX128GAS #10	
C007JD C858JD -W322 CC/UTP(UTR)	356 364	M5356 M5364	E2826P E2827P	D2107L D2107L	H3259M H3259M	P2456-A P2457-A	MH41	MT01	UYX128GAS #10	
C007JD C858JD -U322 CC/UTQ(UTS)	356 364	M5356 M5364	E2826P E2827P	D2107L D2107L	H3259M H3259M	P2456-A P2457-A	—	MT01	UYX128GAS #10	



註(1) : P2544-A/P2545-A為固定式押具舌,亦可使用活動式押具舌 P2565-A代替P2544-A/P2545-A
 P2544-A/P2545-A is the fixed presser foot tongue. It can be replaced by the removable presser foot tongue P2565-A.
 P2446-A/P2447-A為固定式押具舌,亦可使用活動式押具舌 P2466-A代替P2446-A/P2447-A
 P2446-A/P2447-A is the fixed presser tongue. It can be replaced by the removable presser foot tongue P2466-A.

09/12/11

註(2) : C007JD-W/U322A-³⁵⁶/₃₆₄ /CC 時, 該針板與送具改用 C007JD-³⁵⁶/₃₆₄ 之針板與送具, 加附CHJ-A
 When W/U322A-³⁵⁶/₃₆₄ /CC, The needle plate and the feed dog have to be replaced by C007JD-³⁵⁶/₃₆₄ needle plate and the feed dog, with CHJ-A attached.

筒車直驅伺服馬達規格件表 / CONVERSION CHART

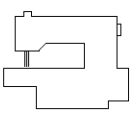
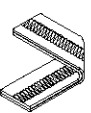
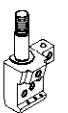
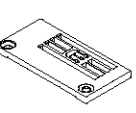
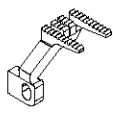
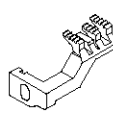
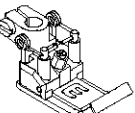
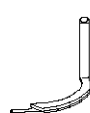
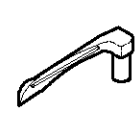

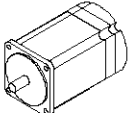



P5-1

										
MODEL	SUB-CLASS	NEEDLE CLAMP	NEEDLE PLATE	MAIN FEED DOG	DIFF. FEED DOG	PRESSER FOOT	SPREADER	LOOPER	NEEDLE	Motor
機 型	規 格	針 座	針 板	主 送 具	差 送 具	押 具	上 叉	勾 針	針 號	馬 達
C007JD C858JD W512 /FE	240 356 364	M5240 M5356 M5364	E 3524R E 3826R E3827R	D 4206 D 4206 D 4207	H 4458 H 4458 H 4459	P2914-A P3216-A P3217-A	MH41	MT01	UYX128GAS #10	☐ T501HE
C007JD C858JD U512 /FE	240 356 364	M5240 M5356 M5364	E 3524R E 3826R E3827R	D 4206 D 4206 D 4207	H 4458 H 4458 H 4459	P3414-A P3716-A P3717-A	—	MT01	UYX128GAS #10	
C007JD C858JD W522 /FE/CR/CL	356 364	M5356 M5364	E 6426R E6427R	D3222	H3268	P3816R-A P3817R-A	MH41	MT01	UYX128GAS #10	
C007JD C858JD U522 /FE/CR/CL	356 364	M5356 M5364	E 6426R E6427R	D3222	H3268	P3816R-A P3817R-A	—	MT01	UYX128GAS #10	
C007JD C858JD W532/ CR/UTP/CL/RLP/CX	356 364	M5356 M5364	E 6426R E6427R	D3222	H3268	P3816R-A P3817R-A	MH41	MT01	UYX128GAS #10	
C007JD C858JD U532/ CR/UTQ/CL/RLP/CX	356 364	M5356 M5364	E 6426R E6427R	D3222	H3268	P3816R-A P3817R-A	MH41	MT01	UYX128GAS #10	
C007JD C858JD W922/ CW	456 464	M5456 M5464	E1828P E1848P	D2107M	H4459M	P2428Q-A P2448Q-A	MH41	MT01B	SMX1014B#10 (MY1014B#70,SY7256)	
C007JD C858JD W922/ CW/UTP	456 464	M5456 M5464	E1828P E1848P	D2107M	H4459M	P2428Q-A P2448Q-A	MH41	MT01B	SMX1014B#10 (MY1014B#70,SY7256)	
C007JD C858JD W922/ CW/UTR	456 464	M5456 M5464	E1828P E1848P	D2107M	H4459M	P2428Q-A P2448Q-A	MH41	MT01B	SMX1014B#10 (MY1014B#70,SY7256)	

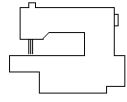
註： C007JD/C858JD 不可加裝FFC

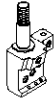
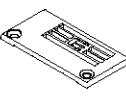
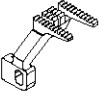
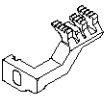
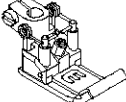
10/07/08



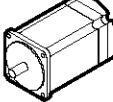



筒車直驅伺服馬達規格件表 / CONVERSION CHART

										
MODEL	SUB-CLASS	NEEDLE CLAMP	NEEDLE PLATE	MAIN FEED DOG	DIFF. FEED DOG	PRESSER FOOT	SPREADER	LOOPER	NEEDLE	Motor
機 型	規 格	針 座	針 板	主 送 具	差 送 具	押 具	上 叉	勾 針	針 號	馬 達
C007JD C858JD-W512 /FE	240 356 364	M5240 M5356 M5364	E 3524R E 3826R E3827R	D 4206 D 4206 D 4207	H 4458 H 4458 H 4459	P2914-A P3216-A P3217-A	MH41	MT01	UYX128GAS #10	T501HE
C007JD C858JD-U512 /FE	240 356 364	M5240 M5356 M5364	E 3524R E 3826R E3827R	D 4206 D 4206 D 4207	H 4458 H 4458 H 4459	P3414-A P3716-A P3717-A	—	MT01	UYX128GAS #10	
C007JD C858JD-W522 /FE/CR/CL	356 364	M5356 M5364	E 6426R E6427R	D 3222	H3268	P3816R-A P3817R-A	MH41	MT01	UYX128GAS #10	
C007JD C858JD-U522 /FE/CR/CL	356 364	M5356 M5364	E 6426R E6427R	D 3222	H3268	P3816R-A P3817R-A	—	MT01	UYX128GAS #10	
C007JD C858JD-W532/ CR/UTP/CL/RLP/CX	356 364	M5356 M5364	E 6426R E6427R	D 3222	H3268	P3816R-A P3817R-A	MH41	MT01	UYX128GAS #10	
C007JD C858JD-U532/ CR/UTQ/CL/RLP/CX	356 364	M5356 M5364	E 6426R E6427R	D 3222	H3268	P3816R-A P3817R-A	MH41	MT01	UYX128GAS #10	
C007JD C858JD-W922/ CW	456 464	M5456 M5464	E1828P E1848P	D2107M	H4459M	P2428Q-A P2448Q-A	MH41	MT01B	SMX1014B#10 (MY1014B#70,SY7256)	
C007JD C858JD-W922/ CW/UTP	456 464	M5456 M5464	E1828P E1848P	D2107M	H4459M	P2428Q-A P2448Q-A	MH41	MT01B	SMX1014B#10 (MY1014B#70,SY7256)	
C007JD C858JD-W922/ CW/UTR	456 464	M5456 M5464	E1828P E1848P	D2107M	H4459M	P2428Q-A P2448Q-A	MH41	MT01B	SMX1014B#10 (MY1014B#70,SY7256)	

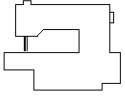
註： C007JD/C858JD不可加裝FFC

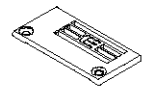
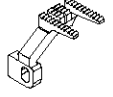
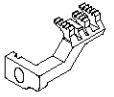
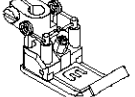
FFC can not be attached to C007JD/C858JD.

筒車直驅伺服馬達規格件表/CONVERSION CHART

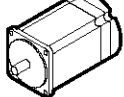
										
MODEL	SUB-CLASS	NEEDLE CLAMP	NEEDLE PLATE	MAIN FEED DOG	DIFF. FEED DOG	PRESSER FOOT	SPREADER	LOOPER	NEEDLE	Motor
機型	規格	針座	針板	主送具	差送具	押具	上叉	勾針	針號	馬達
C007JD-W811 C858JD /CRL/RL	248 356 364	M5248 M5356 M5364	E0215R E0216R E0217R	D2101Q	H2203R	P2765-A P2766-A P2767-A	MH41	MT01	TVX5 #14	T501HE
C007JD-W811A C858JD /CRL/RL	248 356 364	M5248 M5356 M5364	E0215Q E0216Q E0217Q	D2101Q	H2203Q	P2765-A P2766-A P2767-A	MH41	MT01	TVX5 #14	
C007JD-U811 C858JD /CRL/RL	248 356 364	M5248 M5356 M5364	E0215R E0216R E0217R	D2101Q	H2203R	P0965-A P0966-A P0967-A	—	MT01	TVX5 #14	
C007JD-U811A C858JD /CRL/RL	248 356 364	M5248 M5356 M5364	E0215Q E0216Q E0217Q	D2101Q	H2203Q	P0965-A P0966-A P0967-A	—	MT01	TVX5 #14	
C007JD-W811 C858JD CRL/UTP/RL	248 356 364	M5248 M5356 M5364	E0215R E0216R E0217R	D2101Q	H2203R	P2765-A P2766-A P2767-A	MH41	MT01	TVX5 #14	
C007JD-W811A C858JD CRL/UTP/RL	248 356 364	M5248 M5356 M5364	E0215Q E0216Q E0217Q	D2101Q	H2203Q	P2765-A P2766-A P2767-A	MH41	MT01	TVX5 #14	
C007JD-U811 C858JD CRL/UTQ/RL	248 356 364	M5248 M5356 M5364	E0215R E0216R E0217R	D2101Q	H2203R	P0965-A P0966-A P0967-A	—	MT01	TVX5 #14	
C007JD-U811A C858JD CRL/UTQ/RL	248 356 364	M5248 M5356 M5364	E0215Q E0216Q E0217Q	D2101Q	H2203Q	P0965-A P0966-A P0967-A	—	MT01	TVX5 #14	
C007JD-W812 C858JD /CRL/RL	248 356 364	M5248 M5356 M5364	E0225R E0226R E0227R	D2101Q	H2203R	P2765-A P2766-A P2767-A	MH41	MT01	UYX128GAS #10	
C007JD-W812A C858JD /CRL/RL	248 356 364	M5248 M5356 M5364	E0225Q E0226Q E0227Q	D2101Q	H2203Q	P2765-A P2766-A P2767-A	MH41	MT01	UYX128GAS #10	
C007JD-U812 C858JD /CRL/RL	248 356 364	M5248 M5356 M5364	E0225R E0226R E0227R	D2101Q	H2203R	P0965-A P0966-A P0967-A	—	MT01	UYX128GAS #10	
C007JD-U812A C858JD /CRL/RL	248 356 364	M5248 M5356 M5364	E0225Q E0226Q E0227Q	D2101Q	H2203Q	P0965-A P0966-A P0967-A	—	MT01	UYX128GAS #10	







註：C007JD-W812A/W813A機型之針板與差送具為5排齒。

The needle plate and the differential feed dog of W812A/W813A model are five teeth.

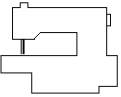
C007JD-W812/W813 機型之針板與差送具為4排齒。

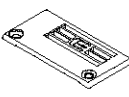
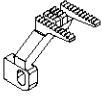
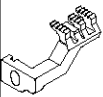
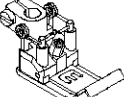
The needle plate and the differential feed dog of W812/W813 model are four teeth.

筒車直驅伺服馬達規格件表/CONVERSION CHART

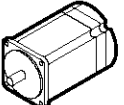
										
MODEL	SUB-CLASS	NEEDLE CLAMP	NEEDLE PLATE	MAIN FEED DOG	DIFF. FEED DOG	PRESSER FOOT	SPREADER	LOOPER	NEEDLE	Motor
機 型	規 格	針 座	針 板	主 送 具	差 送 具	押 具	上 叉	勾 針	針 號	馬 達
C007JD C858JD CRL/UTP/RL	-W812 248 356 364	M5248 M5356 M5364	E0225R E0226R E0227R	D2101Q	H2203R	P2765-A P2766-A P2767-A	MH41	MT01	UYX128GAS #10	T501HE
C007JD C858JD CRL/UTP/RL	-W812A 248 356 364	M5248 M5356 M5364	E0225Q E0226Q E0227Q	D2101Q	H2203Q	P2765-A P2766-A P2767-A	MH41	MT01	UYX128GAS #10	
C007JD C858JD CRL/UTQ/RL	-U812 248 356 364	M5248 M5356 M5364	E0225R E0226R E0227R	D2101Q	H2203R	P0965-A P0966-A P0967-A	—	MT01	UYX128GAS #10	
C007JD C858JD CRL/UTQ/RL	-U812A 248 356 364	M5248 M5356 M5364	E0225Q E0226Q E0227Q	D2101Q	H2203Q	P0965-A P0966-A P0967-A	—	MT01	UYX128GAS #10	
C007JD C858JD /CRL/UTR	-W812 248 356 364	M5248 M5356 M5364	E0225R E0226R E0227R	D2101Q	H2203R	P2765-A P2766-A P2767-A	MH41	MT01	UYX128GAS #10	
C007JD C858JD /CRL/UTR	-W812A 248 356 364	M5248 M5356 M5364	E0225Q E0226Q E0227Q	D2101Q	H2203Q	P2765-A P2766-A P2767-A	MH41	MT01	UYX128GAS #10	
C007JD C858JD /CRL/UTS	-U812 248 356 364	M5248 M5356 M5364	E0225R E0226R E0227R	D2101Q	H2203R	P0965-A P0966-A P0967-A	MH41	MT01	UYX128GAS #10	
C007JD C858JD /CRL/UTS	-U812A 248 356 364	M5248 M5356 M5364	E0225Q E0226Q E0227Q	D2101Q	H2203Q	P0965-A P0966-A P0967-A	MH41	MT01	UYX128GAS #10	
C007JD C858JD /CRL/RL	-W813 248 356 364	M5248 M5356 M5364	E0235R E0236R E0237R	D2101Q	H2203R	P2765-A P2766-A P2767-A	MH41	MT01	UYX128GAS #10	
C007JD C858JD /CRL/RL	-W813A 248 356 364	M5248 M5356 M5364	E0235Q E0236Q E0237Q	D2101Q	H2203Q	P2765-A P2766-A P2767-A	MH41	MT01	UYX128GAS #10	
C007JD C858JD /CRL/RL	-U813 248 356 364	M5248 M5356 M5364	E0235R E0236R E0237R	D2101Q	H2203R	P0965-A P0966-A P0967-A	—	MT01	UYX128GAS #10	
C007JD C858JD /CRL/RL	-U813A 248 356 364	M5248 M5356 M5364	E0235Q E0236Q E0237Q	D2101Q	H2203Q	P0965-A P0966-A P0967-A	—	MT01	UYX128GAS #10	







註：C007JD -W812A/W813A 機型之針板與差送具為 5 排齒。

The needle plate and the differential feed dog of W812A/W813A model are five teeth.

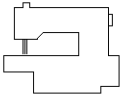
C007JD -W812/W813 機型之針板與差送具為 4 排齒。

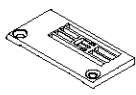
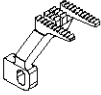
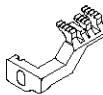
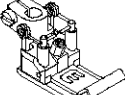
The needle plate and the differential feed dog of W812/W813 model are four teeth.

筒車直驅伺服馬達規格件表 / CONVERSION CHART

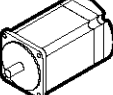
										
MODEL	SUB-CLASS	NEEDLE CLAMP	NEEDLE PLATE	MAIN FEED DOG	DIFF. FEED DOG	PRESSER FOOT	SPREADER	LOOPER	NEEDLE	Motor
機 型	規 格	針 座	針 板	主 送 具	差 送 具	押 具	上 叉	勾 針	針 號	馬 達
C007JD-W813 C858JD-W813 /CRL/UTR	248 356 364	M5248 M5356 M5364	E0235R E0236R E0237R	D2101Q	H2203R	P2765-A P2766-A P2767-A	MH41	MT01	TVX5 #14	☐ T501HE
C007JD-W813A C858JD-W813A /CRL/UTR	248 356 364	M5248 M5356 M5364	E0235Q E0236Q E0237Q	D2101Q	H2203Q	P2765-A P2766-A P2767-A	MH41	MT01	TVX5 #14	
C007JD-U813 C858JD-U813 /CRL/UTS	248 356 364	M5248 M5356 M5364	E0235R E0236R E0237R	D2101Q	H2203R	P0965-A P0966-A P0967-A	MH41	MT01	TVX5 #14	
C007JD-U813A C858JD-U813A /CRL/UTS	248 356 364	M5248 M5356 M5364	E0235Q E0236Q E0237Q	D2101Q	H2203Q	P0965-A P0966-A P0967-A	MH41	MT01	TVX5 #14	
C007JD-W822 C858JD-W822 /CRL/CY/CL/RL	248 356 364	M5248 M5356 M5364	E0225R E0226R E0227R	D2101Q	H2203R	P2765-A P2766-A P2767-A	MH41	MT01	UYX128GAS #10	
C007JD-W823 C858JD-W823 /CRL/CY/CL/RL	248 356 364	M5248 M5356 M5364	E0235R E0236R E0237R	D2101Q	H2203R	P2765-A P2766-A P2767-A	MH41	MT01	TVX5 #14	
C007JD-U822 C858JD-U822 /CRL/CY/CL/RL	248 356 364	M5248 M5356 M5364	E0225R E0226R E0227R	D2101Q	H2203R	P0965-A P0966-A P0967-A	—	MT01	UYX128GAS #10	
C007JD-U823 C858JD-U823 /CRL/CY/CL/RL	248 356 364	M5248 M5356 M5364	E0235R E0236R E0237R	D2101Q	H2203R	P0965-A P0966-A P0967-A	—	MT01	TVX5 #14	
C007JD-W822 C858JD-W822 CRL/CY/UTP/CL/RL	248 356 364	M5248 M5356 M5364	E0225R E0226R E0227R	D2101Q	H2203R	P2765-A P2766-A P2767-A	MH41	MT01	UYX128GAS #10	
C007JD-W823 C858JD-W823 CRL/CY/UTP/CL/RL	248 356 364	M5248 M5356 M5364	E0235R E0236R E0237R	D2101Q	H2203R	P2765-A P2766-A P2767-A	MH41	MT01	TVX5 #14	

註：C007JD-W812A/W813A 機型之針板與差送具為 5 排齒。
C858JD







The needle plate and the differential feed dog of W812A/W813A model are five teeth.

C007JD-W812/W813 機型之針板與差送具為 4 排齒。
C858JD

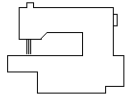
The needle plate and the differential feed dog of W812/W813 model are four teeth.

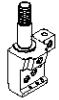
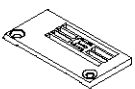
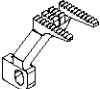
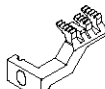
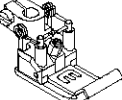
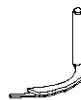
筒車直驅伺服馬達規格件表 / CONVERSION CHART

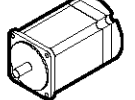





P10

										
MODEL	SUB-CLASS	NEEDLE CLAMP	NEEDLE PLATE	MAIN FEED DOG	DIFF. FEED DOG	PRESSER FOOT	SPREADER	LOOPER	NEEDLE	Motor
機 型	規 格	針 座	針 板	主 送 具	差 送 具	押 具	上 叉	勾 針	針 號	馬 達
C007JD-U822 C858JD CRL/CY/UTQ/CL/RL	248 356 364	M5248 M5356 M5364	E0225R E0226R E0227R	D2101Q	H2203R	P0965-A P0966-A P0967-A	—	MT01	UYX128GAS #10	 T501HE
C007JD-U823 C858JD CRL/CY/UTQ/CL/RL	248 356 364	M5248 M5356 M5364	E0235R E0236R E0237R	D2101Q	H2203R	P0965-A P0966-A P0967-A	—	MT01	TVX5 #14	
C007JD-U822 C858JD CRL/CY/UTQ/CL/RL	248 356 364	M5248 M5356 M5364	E0225R E0226R E0227R	D2101Q	H2203R	P0965-A P0966-A P0967-A	—	MT01	UYX128GAS #10	
C007JD-U823 C858JD CRL/CY/UTQ/CL/RL	248 356 364	M5248 M5356 M5364	E0235R E0236R E0237R	D2101Q	H2203R	P0965-A P0966-A P0967-A	—	MT01	TVX5 #14	
C007JD-U822 C858JD CRL/CY/UTQ/CL/RL	248 356 364	M5248 M5356 M5364	E0225R E0226R E0227R	D2101Q	H2203R	P0965-A P0966-A P0967-A	—	MT01	UYX128GAS #10	

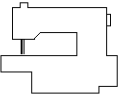
09/12/11

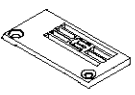
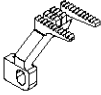
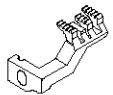
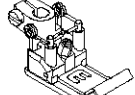
筒車直驅伺服馬達規格件表 / CONVERSION CHART

P11

										
MODEL	SUB-CLASS	NEEDLE CLAMP	NEEDLE PLATE	MAIN FEED DOG	DIFF. FEED DOG	PRESSER FOOT	SPREADER	LOOPER	CAM	NEEDLE
機 型	規 格	針 座	針 板	主 送 具	差 送 具	押 具	上 叉	勾 針	偏 心 凸 輪	針 號
C007JD-W522 C858JD /FE(FFC)/CRB/CL	356 364	M5356 M5364	E 6426P E 6427P	D 3222	H 3268	P3116 P3117	MH41E	MT01	MF01-A	UYX128GAS #11
C007JD-U522 C858JD /FE(FFC)/CRB/CL	356 364	M5356 M5364	E 6426P E 6427P	D 3222	H 3268	P3116 P3117	—	MT01	MF01-A	UYX128GAS #11
C007JD-W812 C858JD /CRL/RL	248 356 364	M5248 M5356 M5364	E 0225R E 0226R E 0227R	D2101Q	H2203R	P2765 P2766 P2767	MH41E	MT01	MF91-A	UYX128GAS #11
C007JD-U812 C858JD /CRL/RL	248 356 364	M5248 M5356 M5364	E 0225R E 0226R E 0227R	D2101Q	H2203R	P0965 P0966 P0967	—	MT01	MF91-A	UYX128GAS #11
C007JD-W813 C858JD /CRL/RL	248 356 364	M5248 M5356 M5364	E 0235R E 0236R E 0237R	D2101Q	H2203R	P2765 P2766 P2767	MH41E	MT01	MF91-A	UYX128GAS #11
C007JD-U813 C858JD /CRL/RL	248 356 364	M5248 M5356 M5364	E 0235R E 0236R E 0237R	D2101Q	H2203R	P0965 P0966 P0967	—	MT01	MF91-A	UYX128GAS #11

09/12/11

C007JD PARTS LIST FOR MF GROUP P.1/1

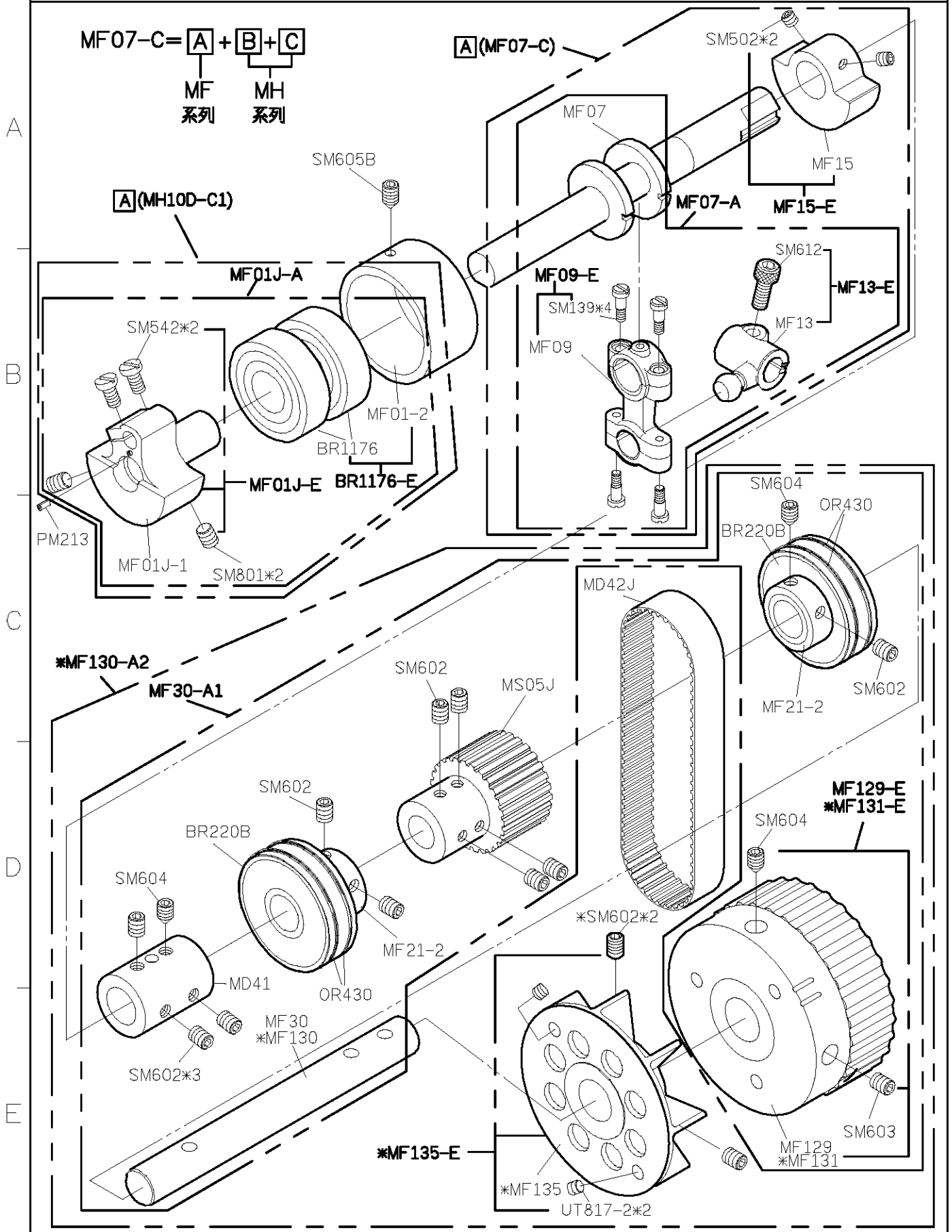

FOR C007J/C007JD/C858J/C858JD/S007K/S007KD
 *USE FOR C007JD/C858JD/S007KD

11/08/29

C007JD PARTS LIST FOR MG GROUP P.1/1

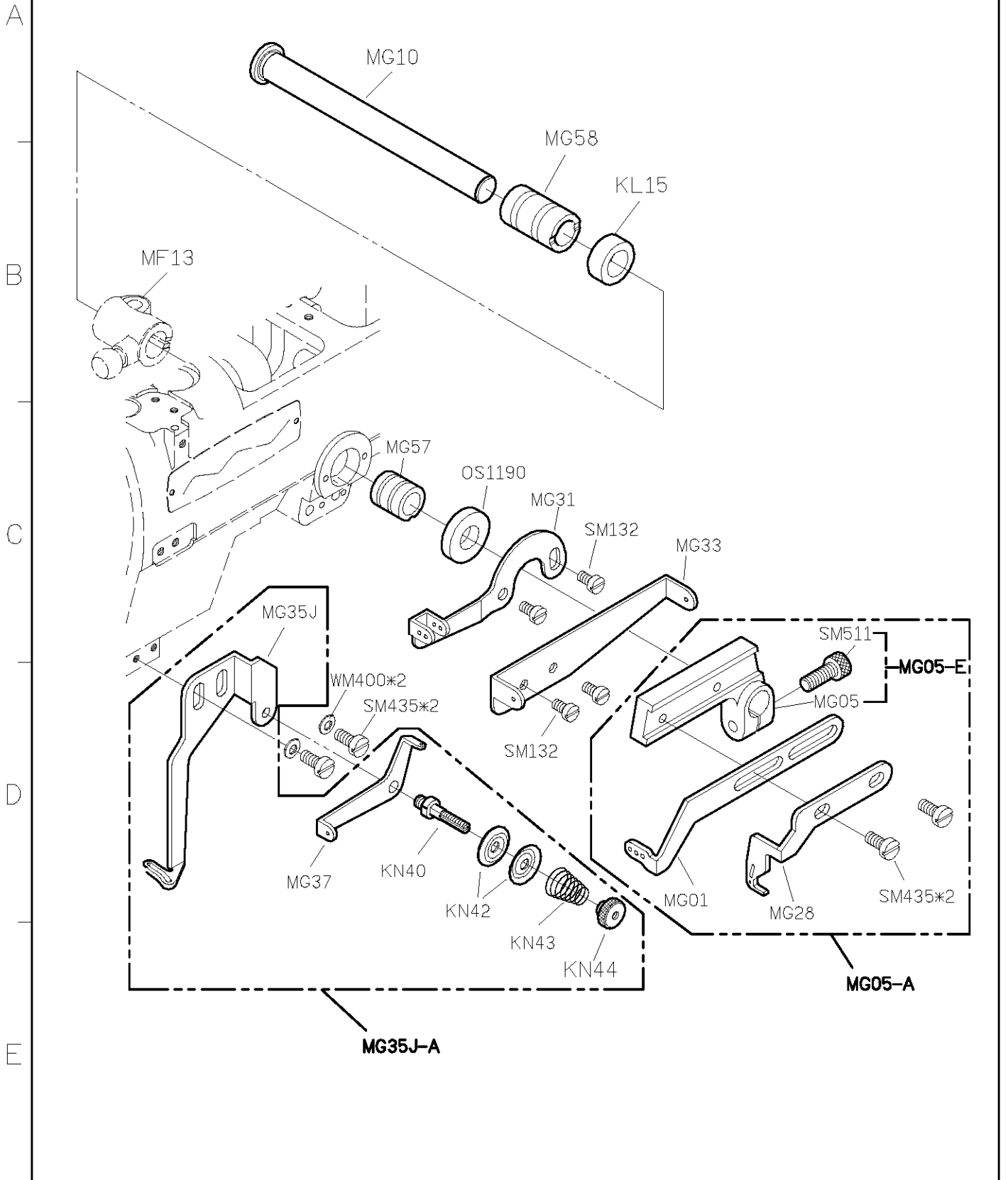

1
FOR C007J/C007JD/S007K/S007KD

2

3

4

5

11/09/24

C007JD PARTS LIST FOR MH GROUP P.1/1

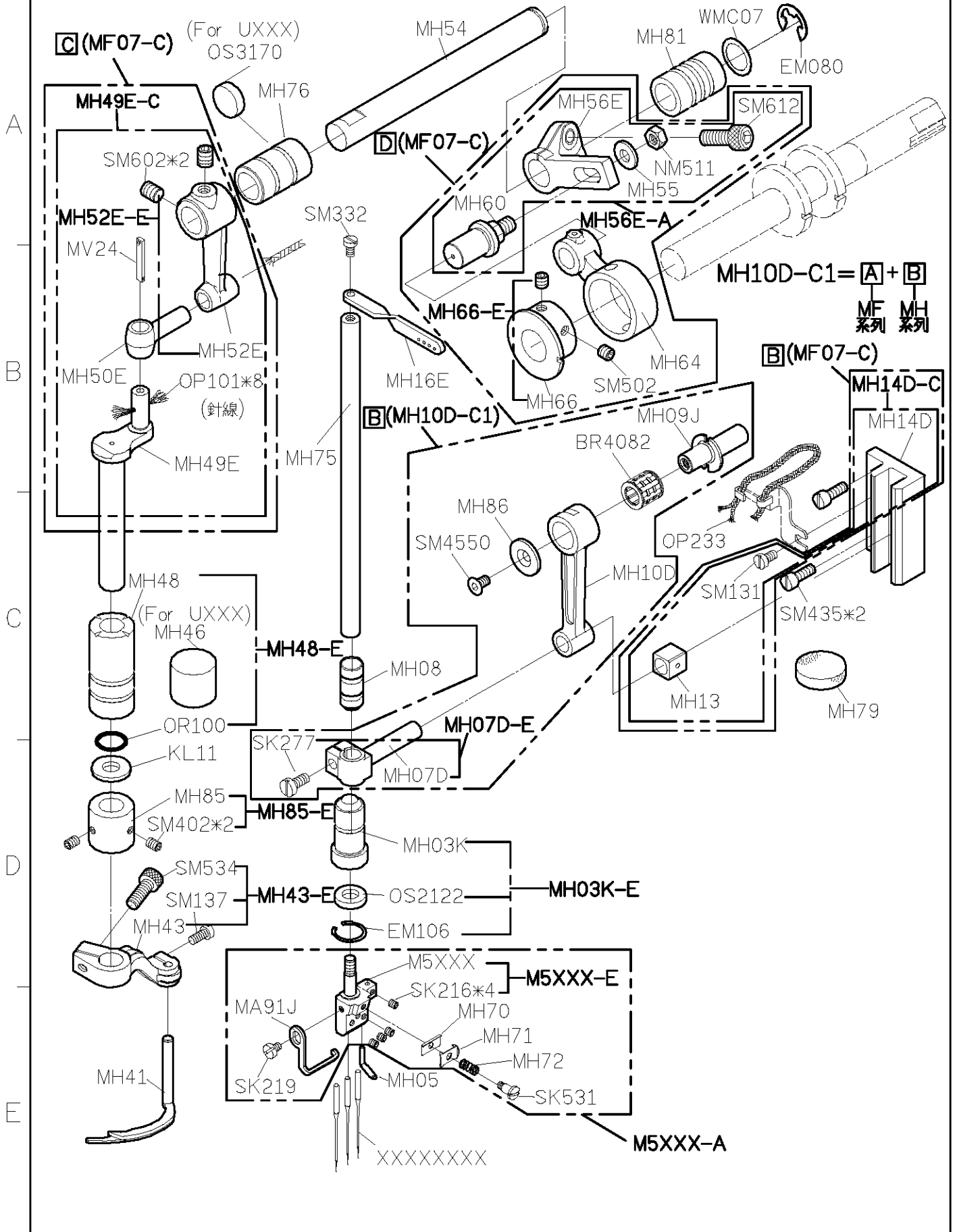

FOR C007J/C007JD/S007K/S007KD

12/03/15

C007JD PARTS LIST FOR MJ GROUP P.1/1

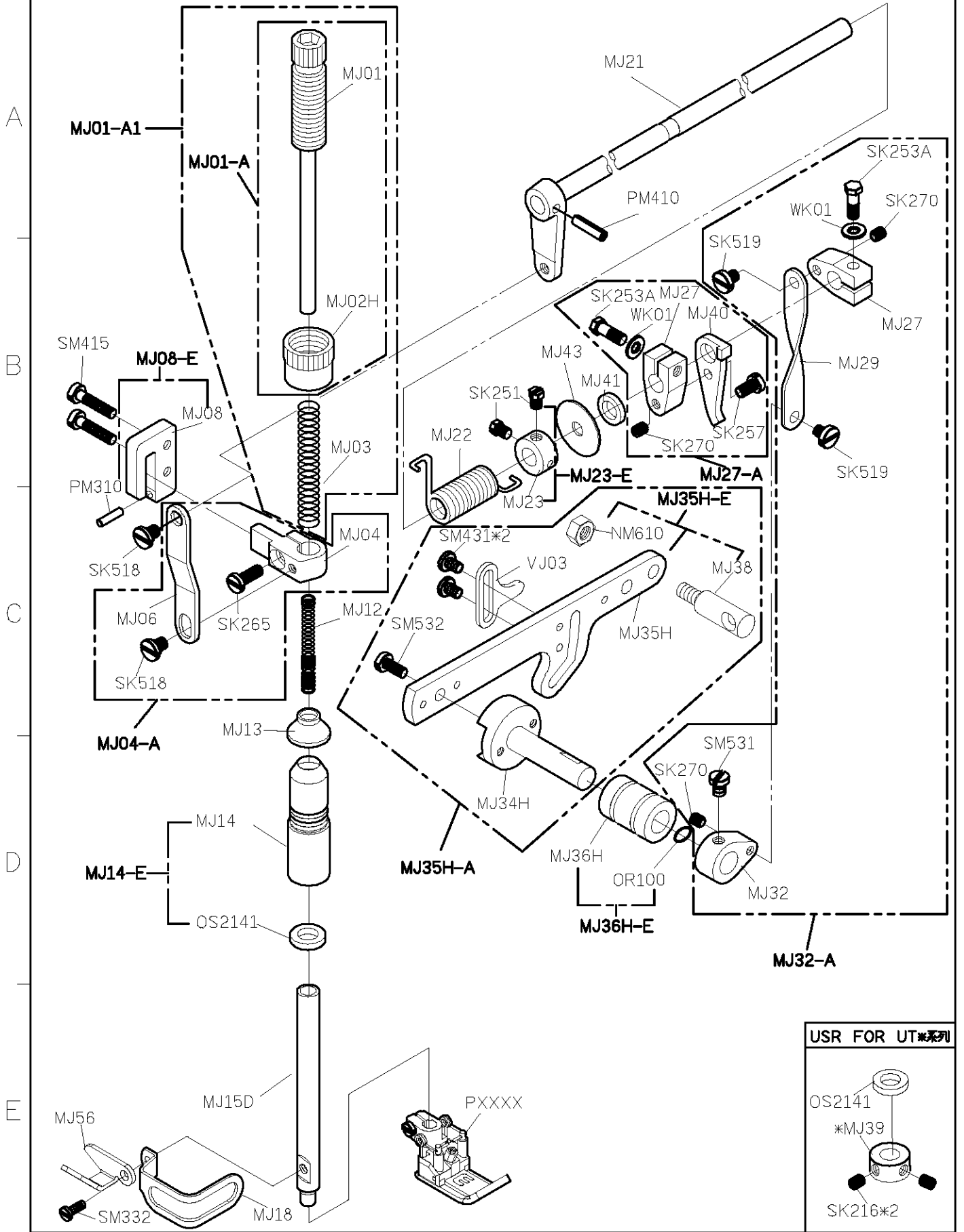

FOR C007J/C007JD/S007K/S007KD

11/06/07

C007JD PARTS LIST FOR MK GROUP P.1/1

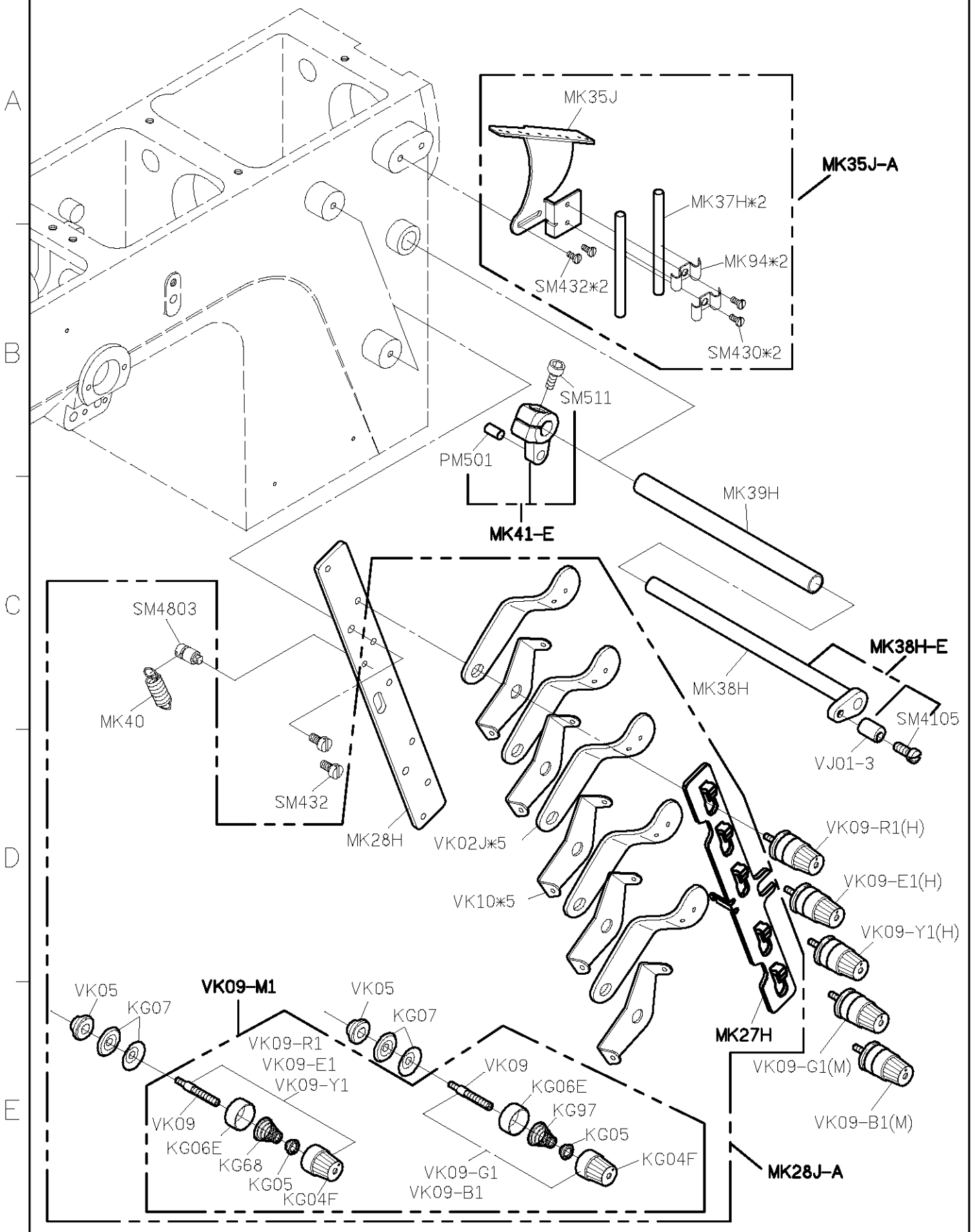

FOR C007J/C007JD/F007J/F007JD/S007K/KD

11/08/12

PARTS LIST FOR MN GROUP P.1/2

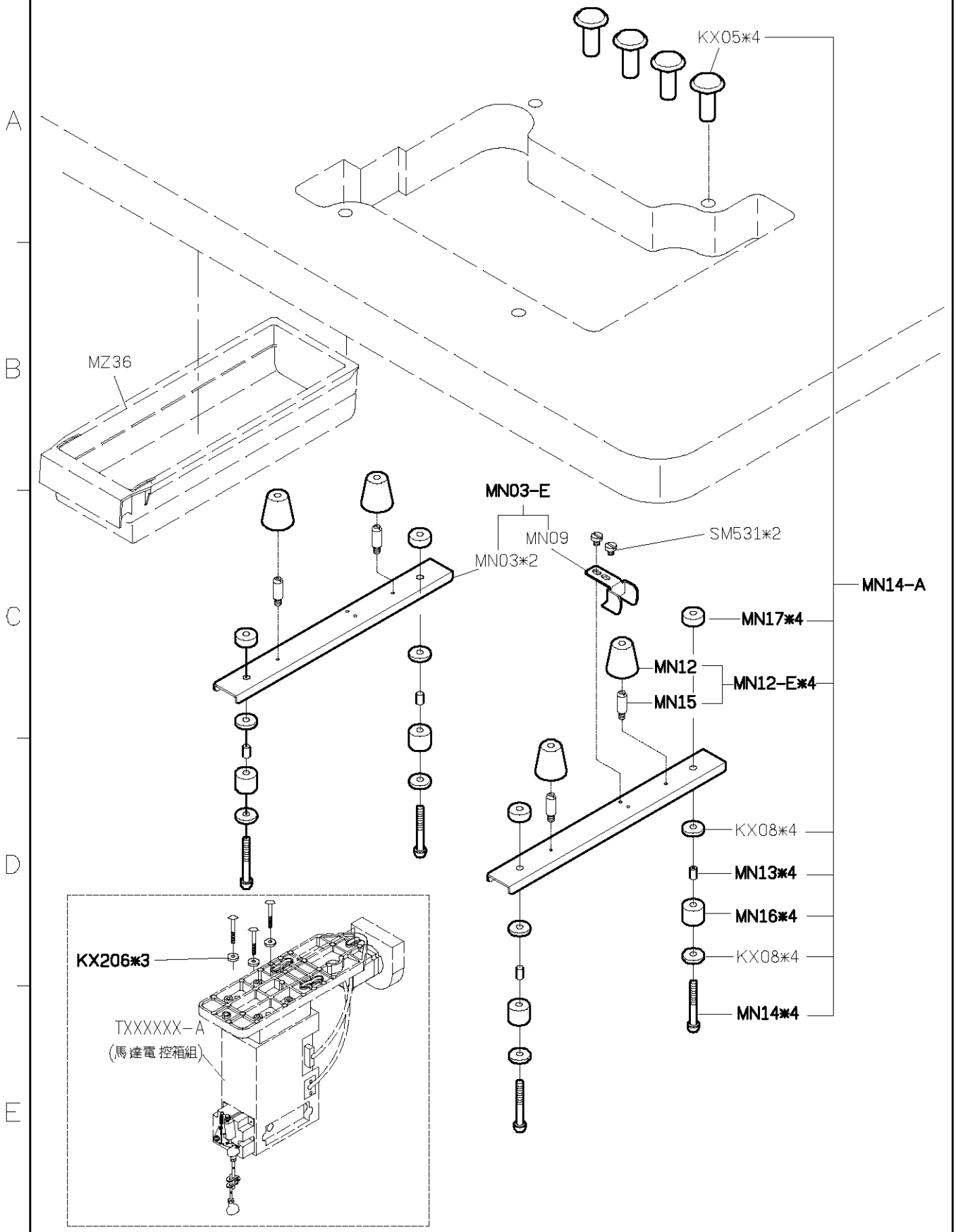

FOR C007J/C007JD/C858J/C858JD/S007K/S007KD

12/04/06

PARTS LIST FOR MN GROUP P.2/2

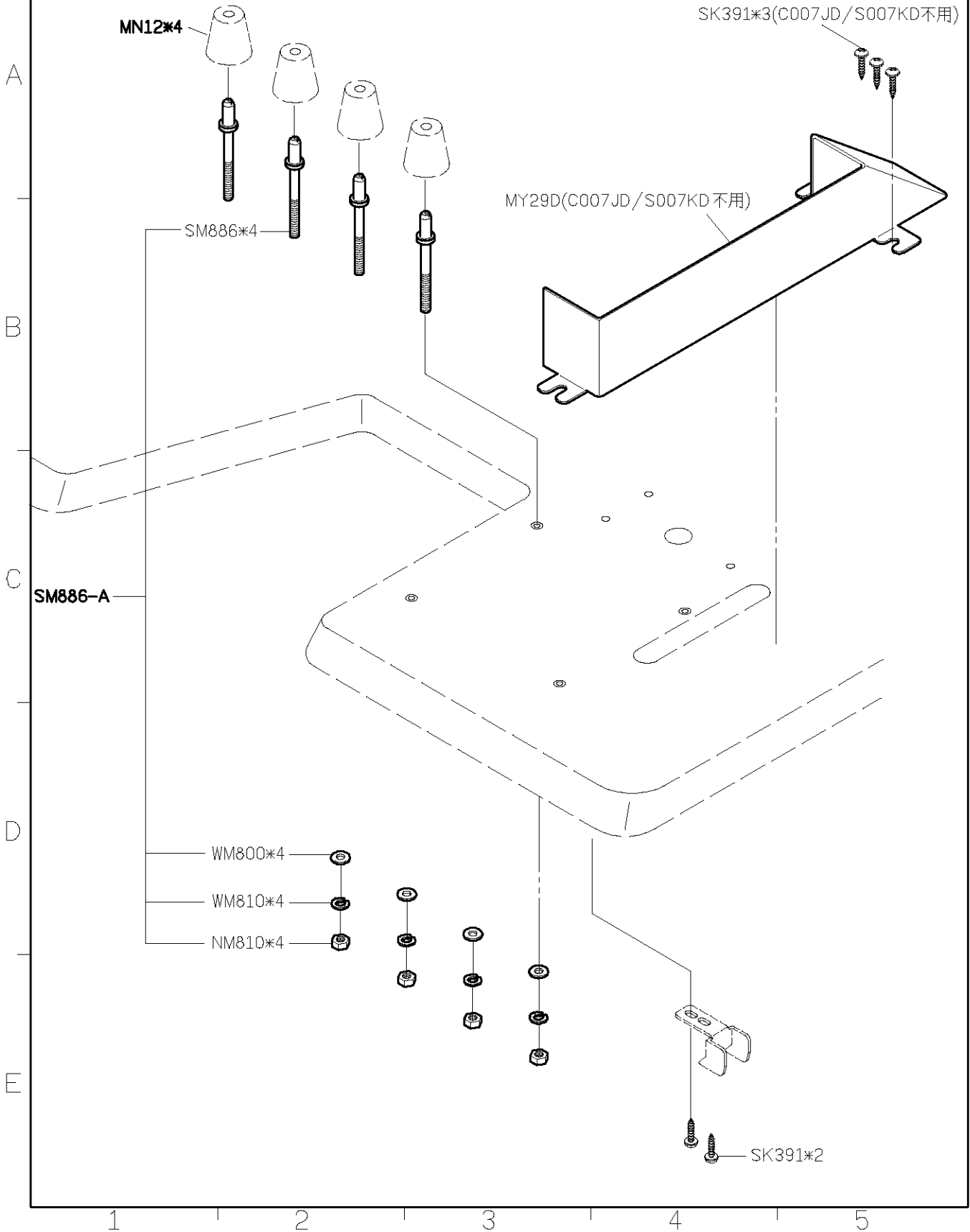

FOR C007J/C007JD/C858J/C858JD/S007K/S007KD

12/04/06

C007JD PARTS LIST FOR MQ-J GROUP P.1/1

選配件

PARTS NO.	MQ42
-----------	------

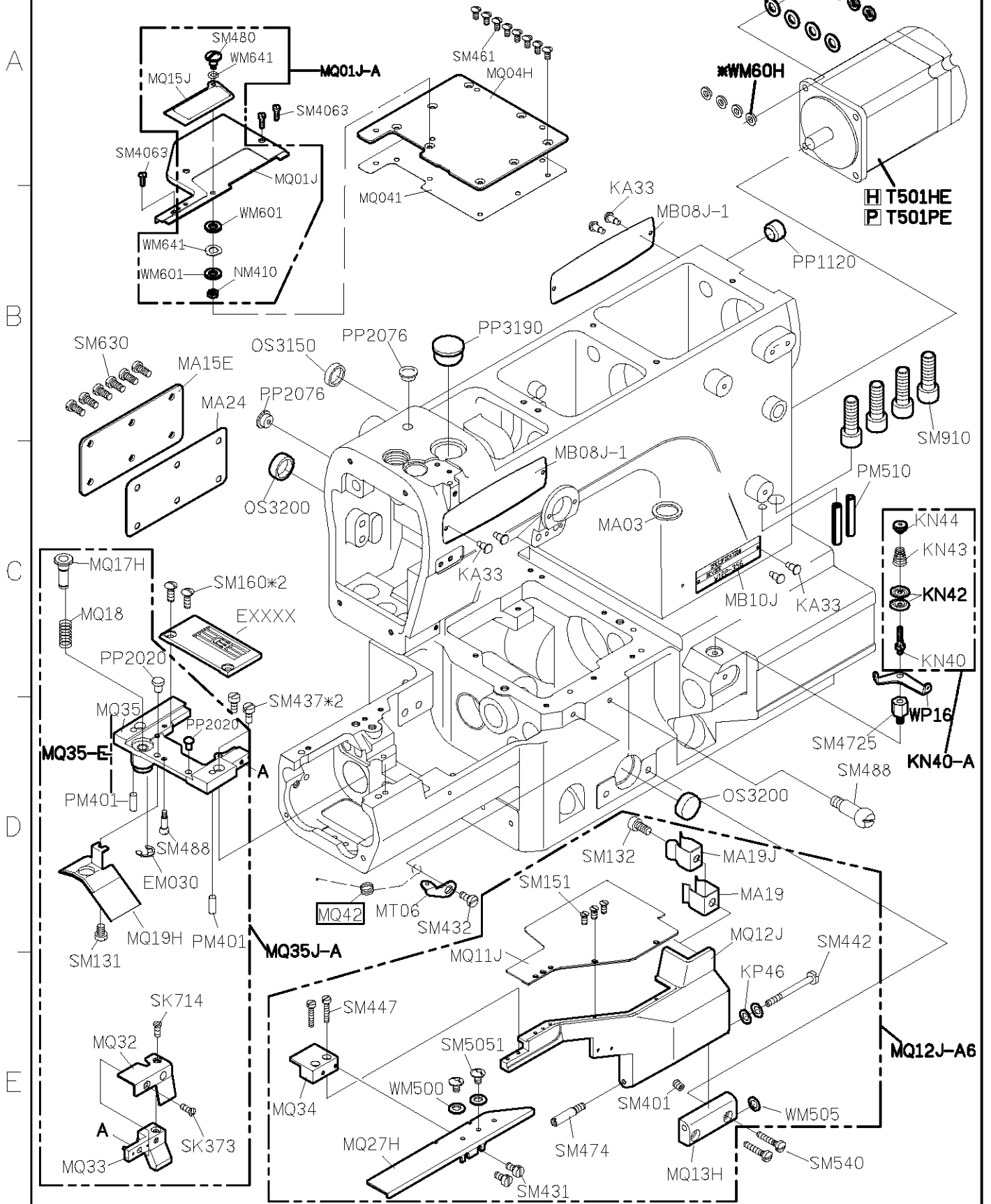

1 FOR C007J/C007JD/C858J/C858JD 2 3 H FOR C007JD/C858JD H牌機 4 5 11/03/14

C007JD PARTS LIST FOR MR-J GROUP P.1/1

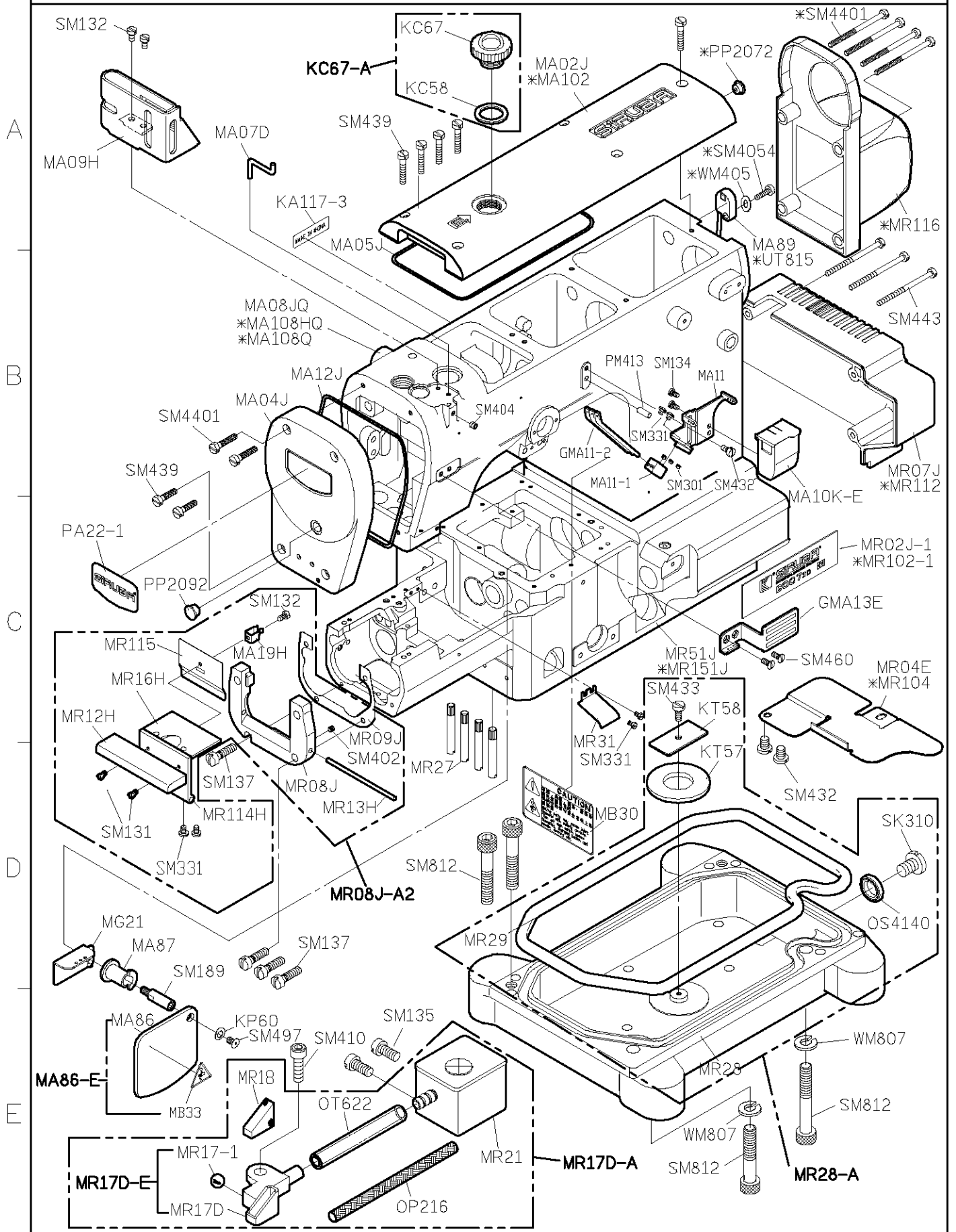

FOR C007J/C007JD/C858J/C858JD
 *USE FOR C007JD/C858JD

11/08/09

PARTS LIST FOR MT GROUP P.1/1

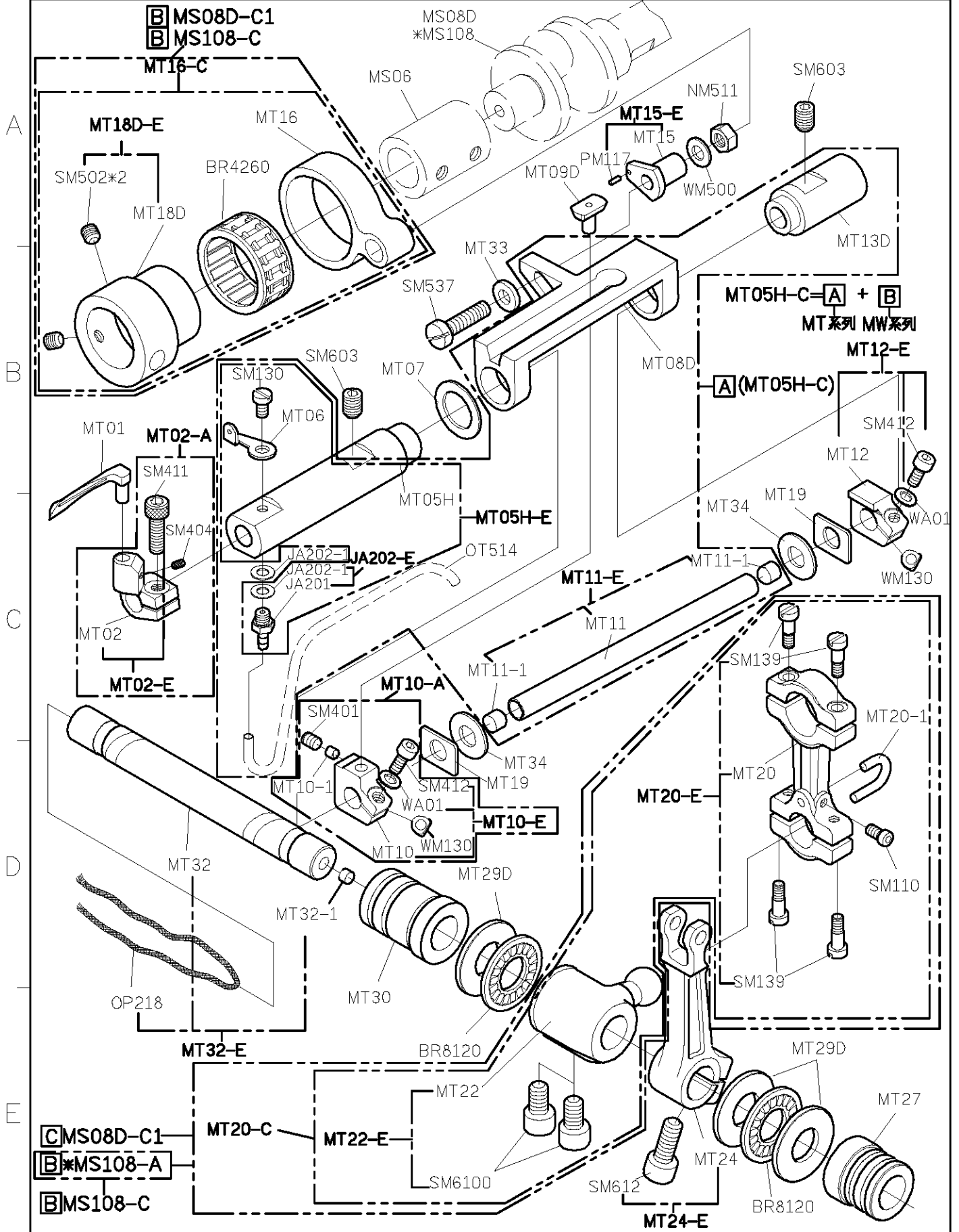

FOR C007J/C007JD/C858J/C858JD
 *USE FOR C007JD/C858JD

11/12/21

C007JD PARTS LIST FOR MU GROUP P.1/1

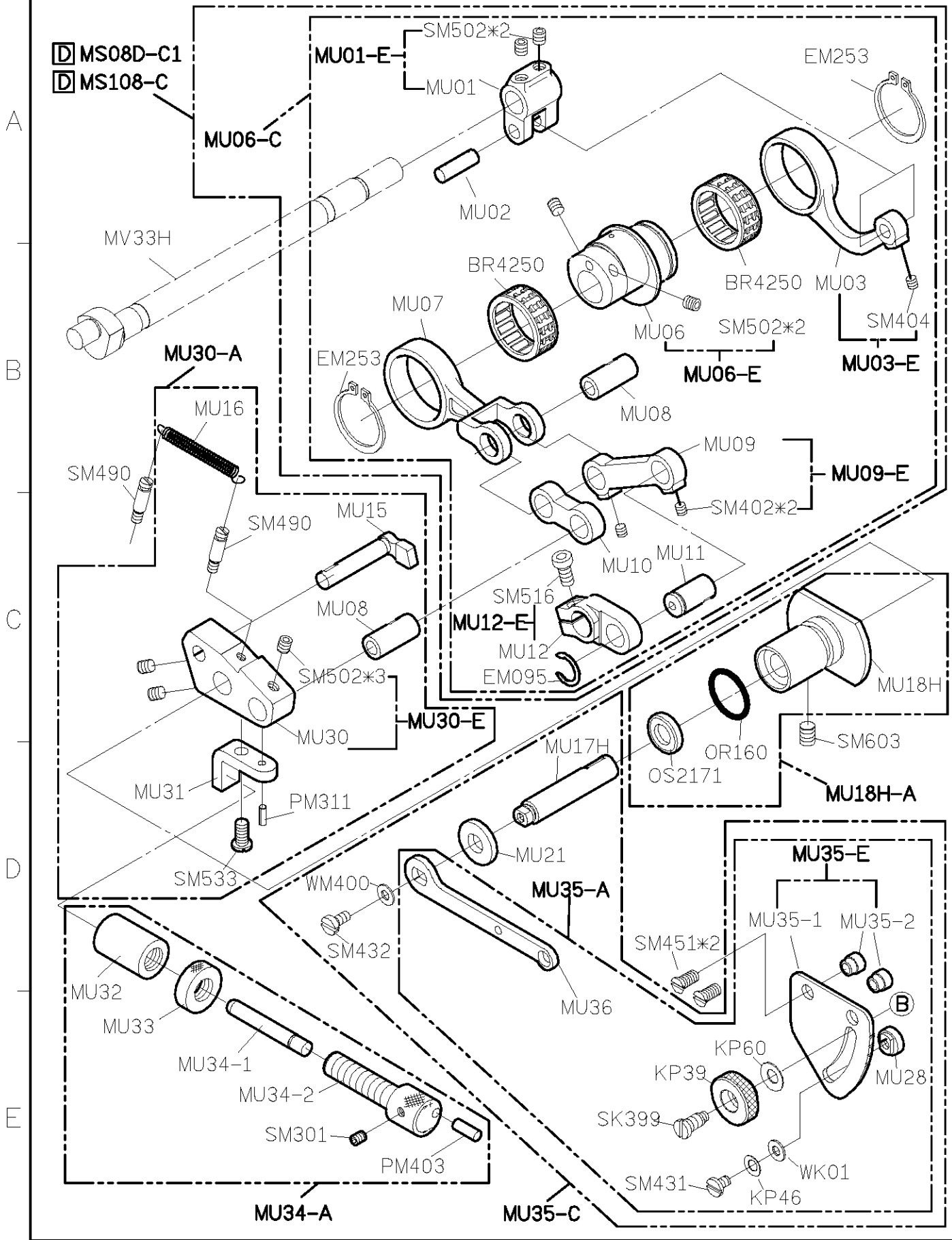

C007JD PARTS LIST FOR MV GROUP P.1/1

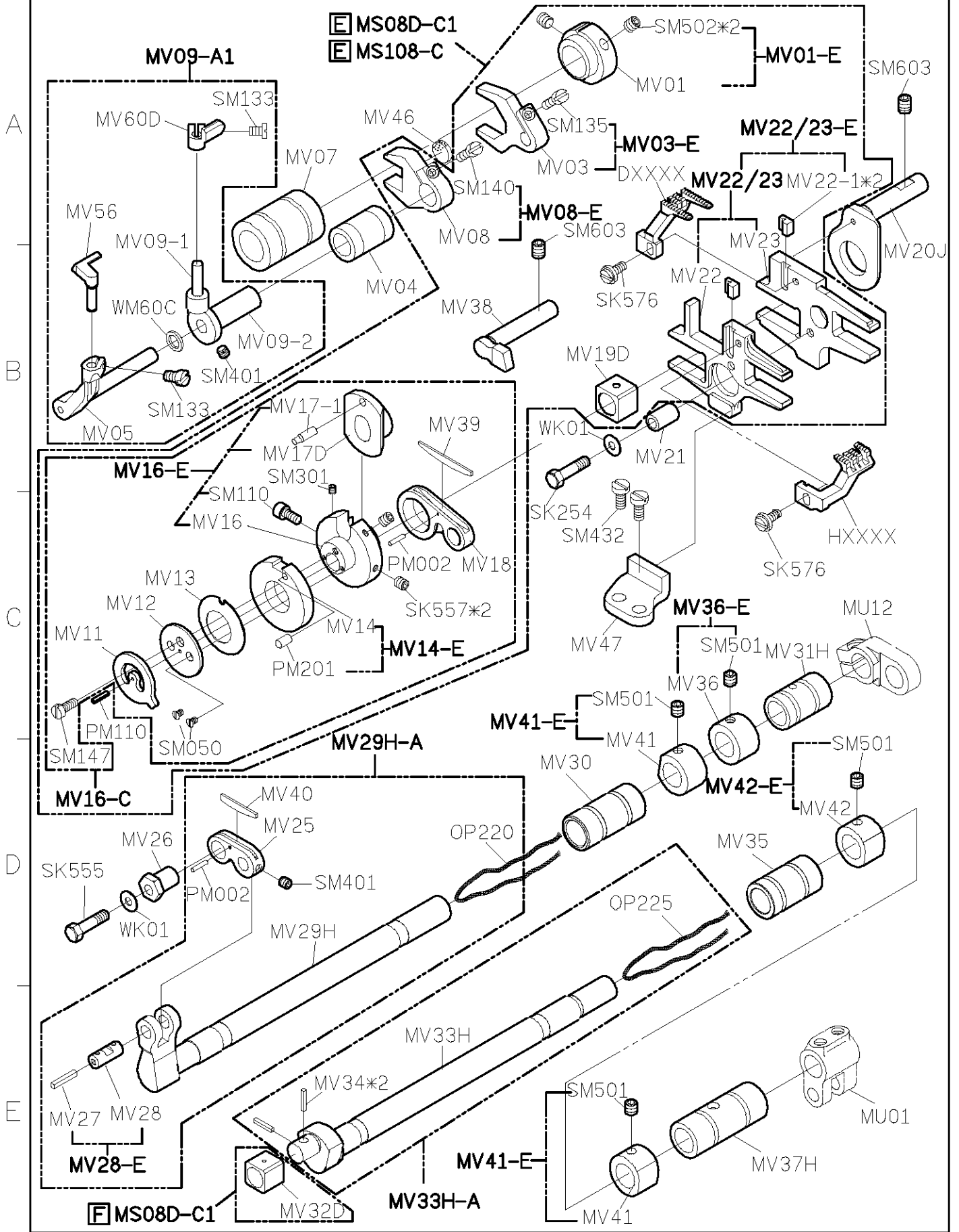

FOR C007J/C007JD/C858J/C858JD 11/09/29

C007JD PARTS LIST FOR MW GROUP P.1/1

A

B

C

D

E

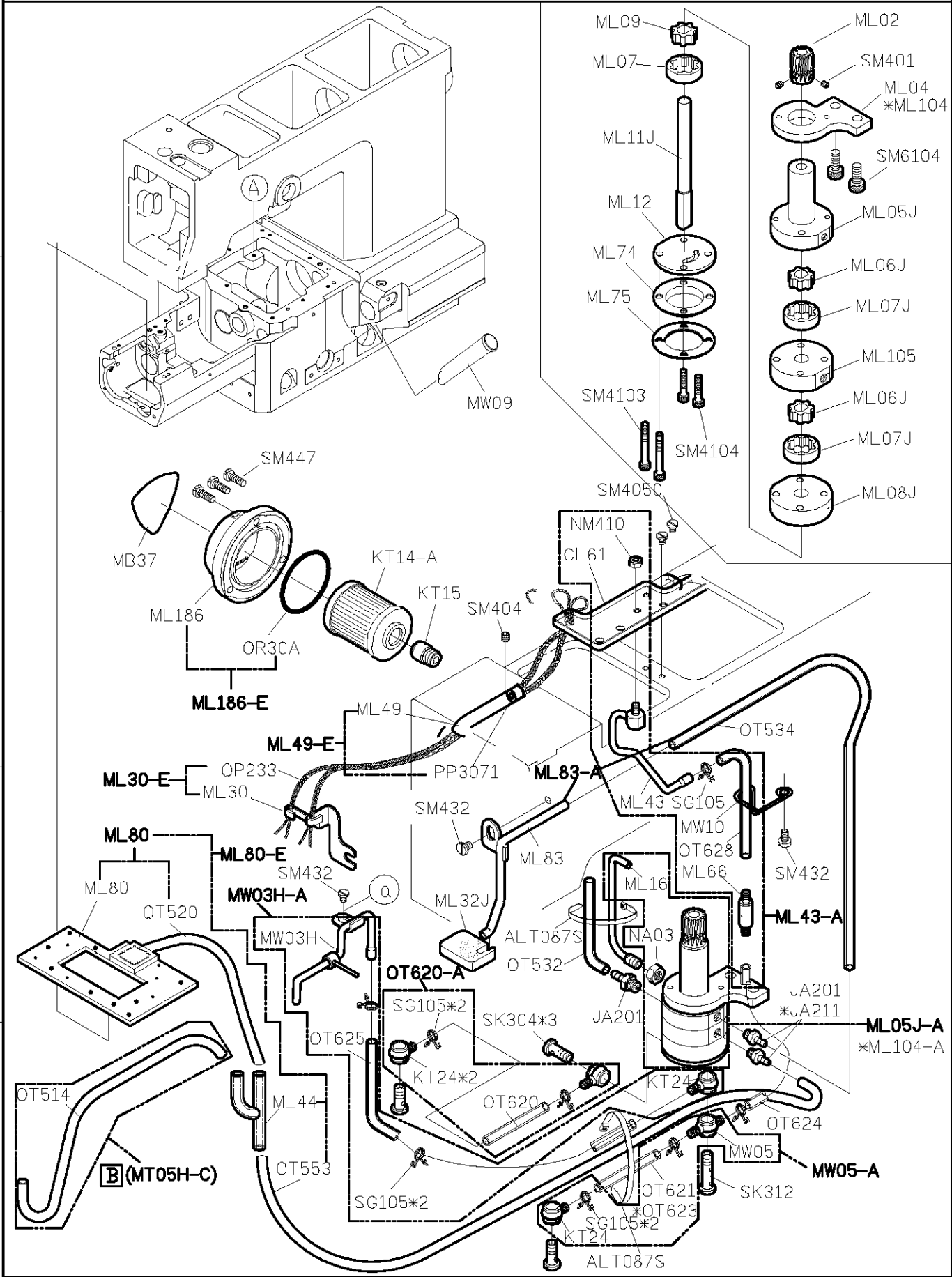



FOR C007J/C007JD/C858J/C858JD
 *USE FOR C007JD/C858JD

10/12/16

From the library of: Superior Sewing Machine & Supply LLC

C007JD PARTS LIST FOR MY GROUP P.1/1

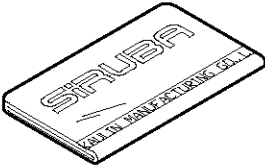

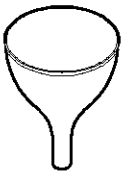
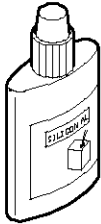
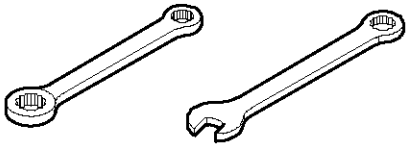

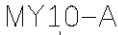

A

MY01  KY03  KY04  KY05-A  KY23-A 

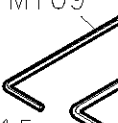

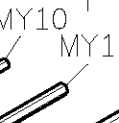
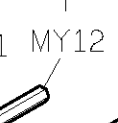

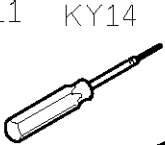
 KY23(6/7mm) KY09

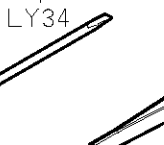
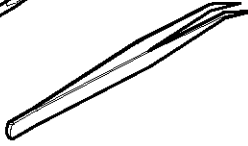
B

MY10-A 

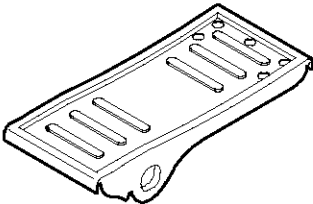

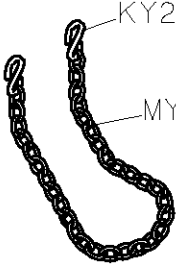
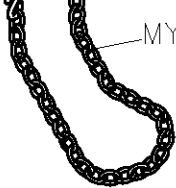

 MY09  1.5
 KY10  2
 MY10  2.5
 MY11  3
 MY12  4
 KY11  5
 KY14  LY33-A  LY33 LY34  KY18 



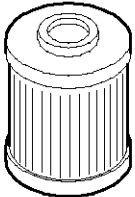
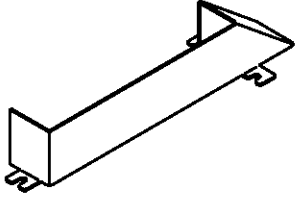

C

KY20D-A  針*5  KY21-1  MY21  -MY21-E KY201  KZ03*1 

D

KT14-A  MY29D 

 △SM886-A  SM886*4  WM800*4
 WM810*4  NM810*4
 SK391*5 

 □ SM886-A1  SM886*4  WM800*4
 WM810*4  NM810*4
 SK391*2 

E

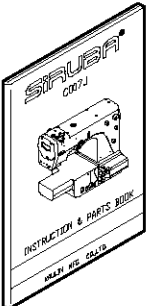
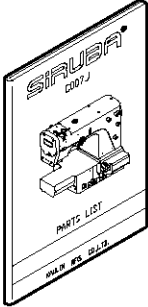
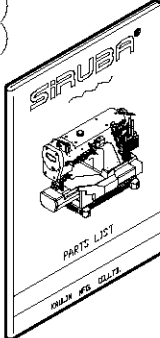
MY45  使用説明書
 MY46  零件圖
 MY47  筒車特殊件零件圖
 (UT975)
 (UT976)

零件圖	
基本車	MY46
特種車	MY46 MY47
UTP/UTQ	MY46 UT975
特種車 + UTP/UTQ	MY46 MY47 UT975
UTR/UTS	MY46 UT976
特種車 + UTR/UTS	MY46 MY47 UT976

PARTS LIST FOR MZ GROUP 系列圖 1

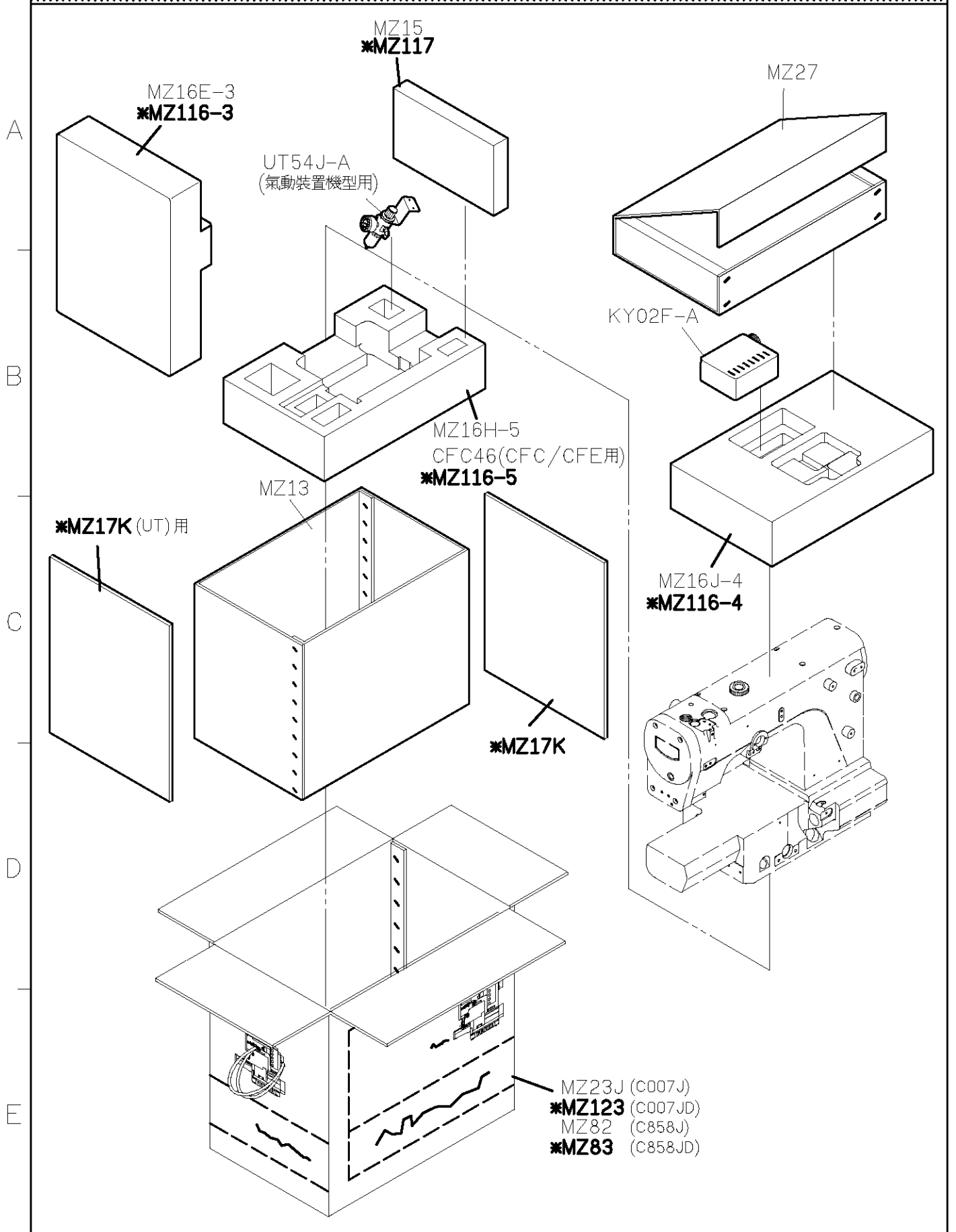

FOR C007J/C858J
 *USE FOR C007JD/C858JD

11/12/23

TABLE CUT-OUT OF C007-T22

三針筒車下乘桌板圖

C007J SERIES TABLE CUT-OUT SEMI-SUBMERGED

單位/UNIT:mm

FOR CRB

所有尺寸公差/DIFFERENCE:±2

C007-T22-1070長度(L):1070/重量:11.5kg±5%

C007-T22長度(L):1200/重量:12.5kg±5%

全封邊灰格紋光塑面台板

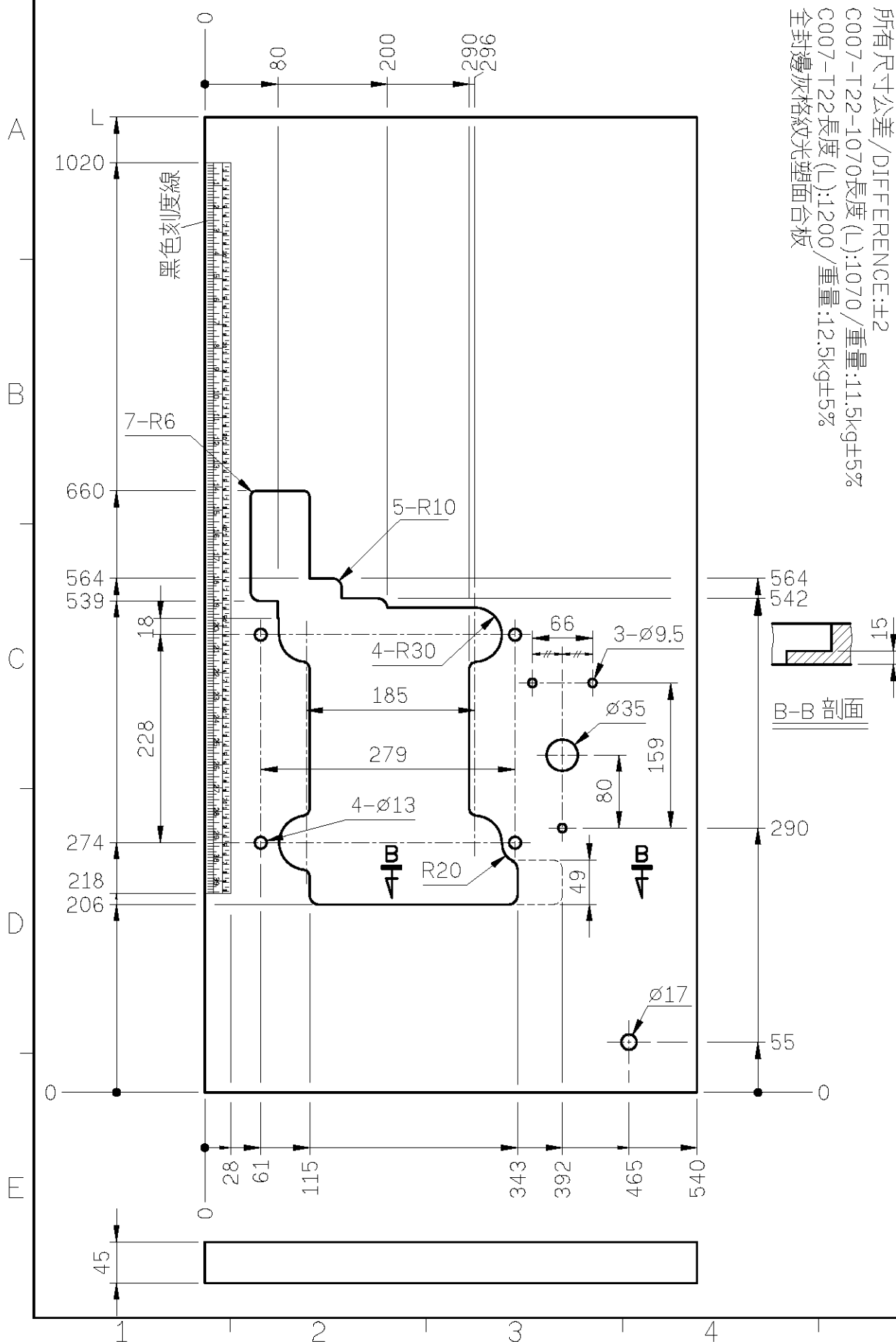

TABLE CUT-OUT OF C007-T23

三針筒車下乘桌板圖

C007K/C007KD/C007J/C007JD/S007K/S007KD SERIES TABLE CUT-OUT SEMI-SUBMERGED

單位/UNIT:mm

FOR一般車及自動切線

所有尺寸公差/DIFFERENCE:±2

C007-T23-1070長度(L):1070/重量:11.5kg±5%

C007-T23長度(L):1200/重量:12.5kg±5%

全封邊灰格紋光塑面台板

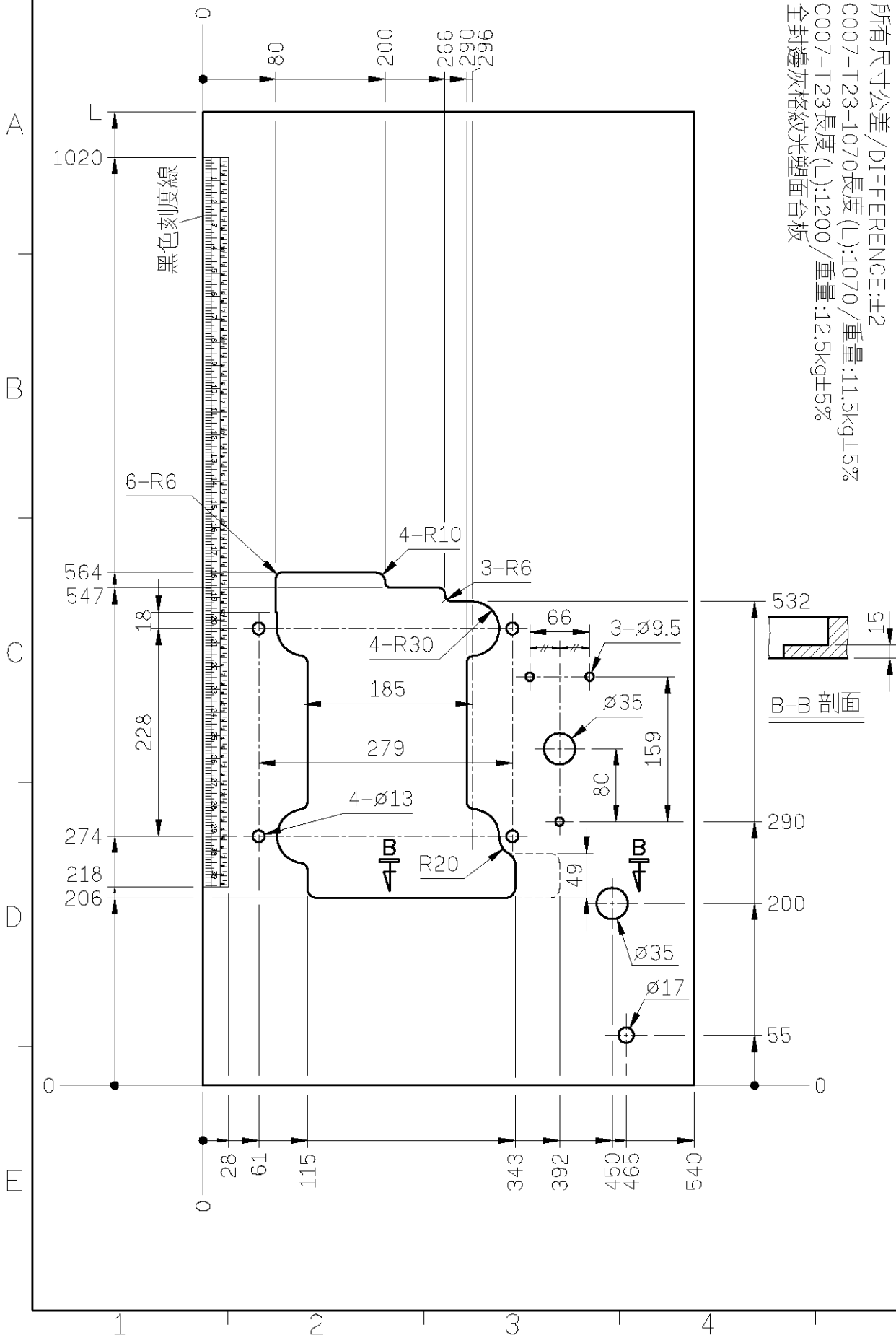

TABLE CUT-OUT OF C007-T24

三針筒車上乘桌板圖
 C007J SERIES TABLE CUT-OUT SEMI-SUBMERGED
 單位/UNIT:mm

FOR 一般車及自動切線
 所有尺寸公差/DIFFERENCE:±2
 C007-T24-1070長度(L):1070/重量:11.3kg±5%
 C007-T24長度(L):1200/重量:12.3kg±5%
 全封邊灰格紋光塑面台板

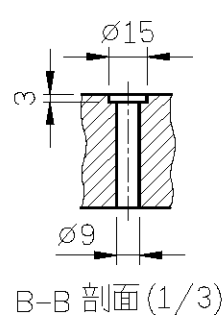
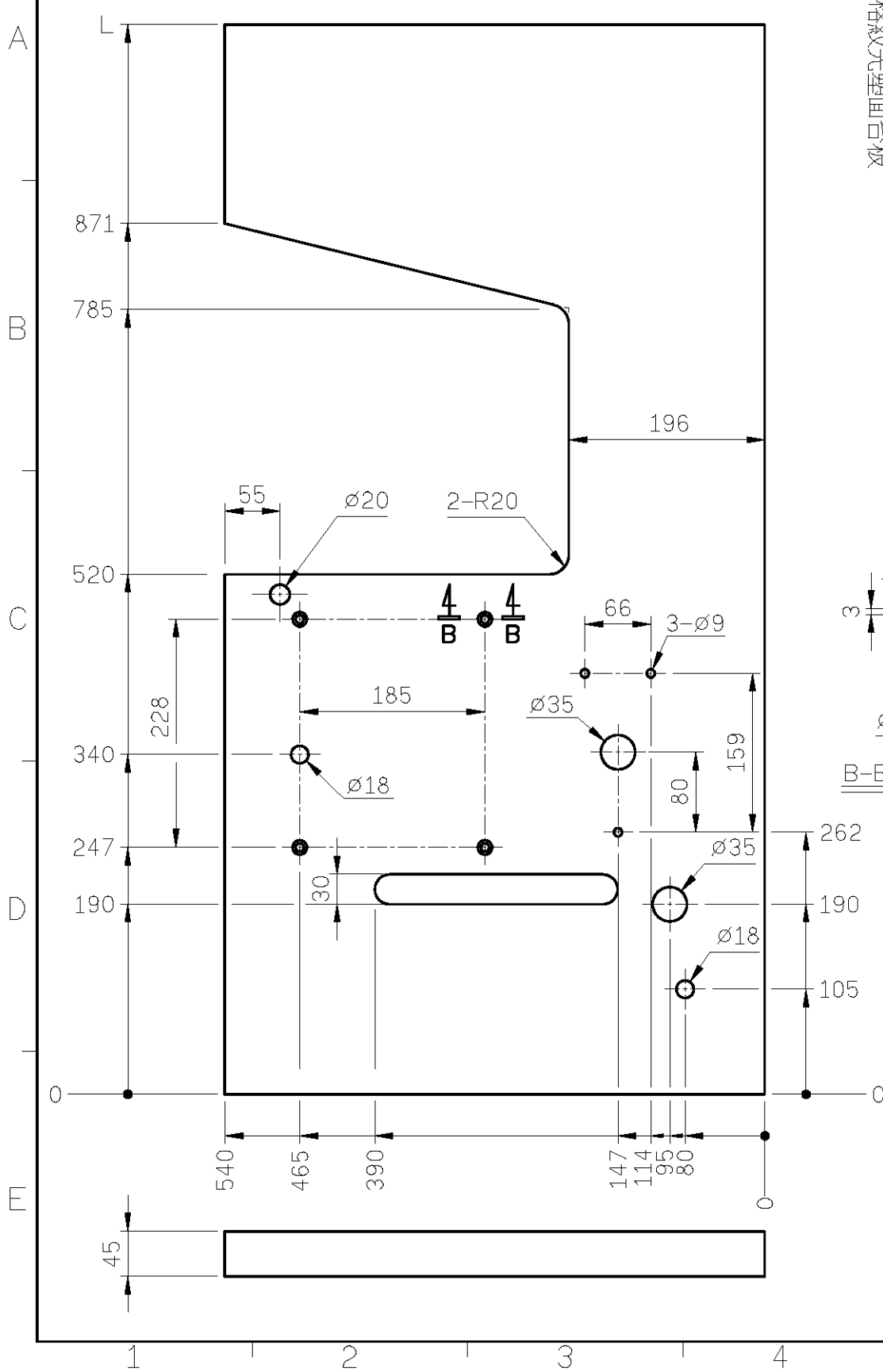

TABLE CUT-OUT OF C007-T25

三針筒車上乘桌板圖

C007J/C007JD/S007K/S007KD SERIES TABLE CUT-OUT SEMI-SUBMERGED

單位/UNIT:mm

FOR CRL,CRL/UTP,Q

所有尺寸公差/DIFFERENCE:±2

C007-T25-1070長度(L):1070/重量:11.3kg±5%

C007-T25長度(L):1200/重量:12.3kg±5%

全封邊灰格紋光塑面台板

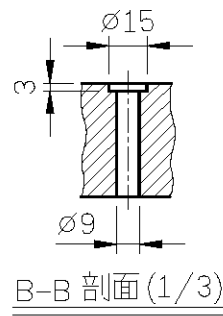
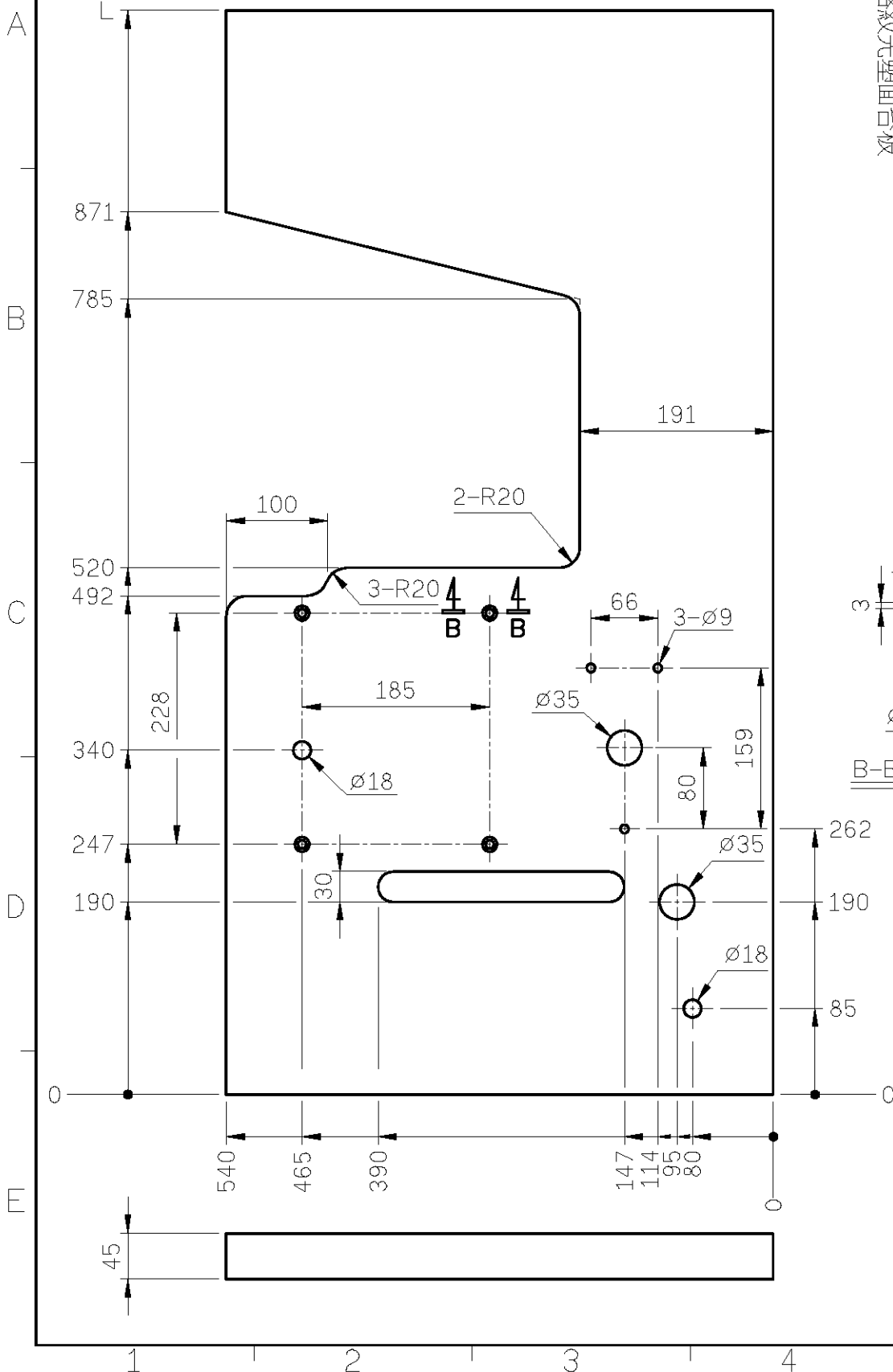

TABLE CUT-OUT OF C007-T26

三針筒車下乘桌板圖

C007J SERIES TABLE CUT-OUT SEMI-SUBMERGED

單位/UNIT:mm

FOR CFC/CFE

所有尺寸公差/DIFFERENCE:±2

C007-T26-1070長度(L):1070/重量:11.4kg±5%

C007-T26長度(L):1200/重量:12.4kg±5%

全封邊灰格紋光塑面台板

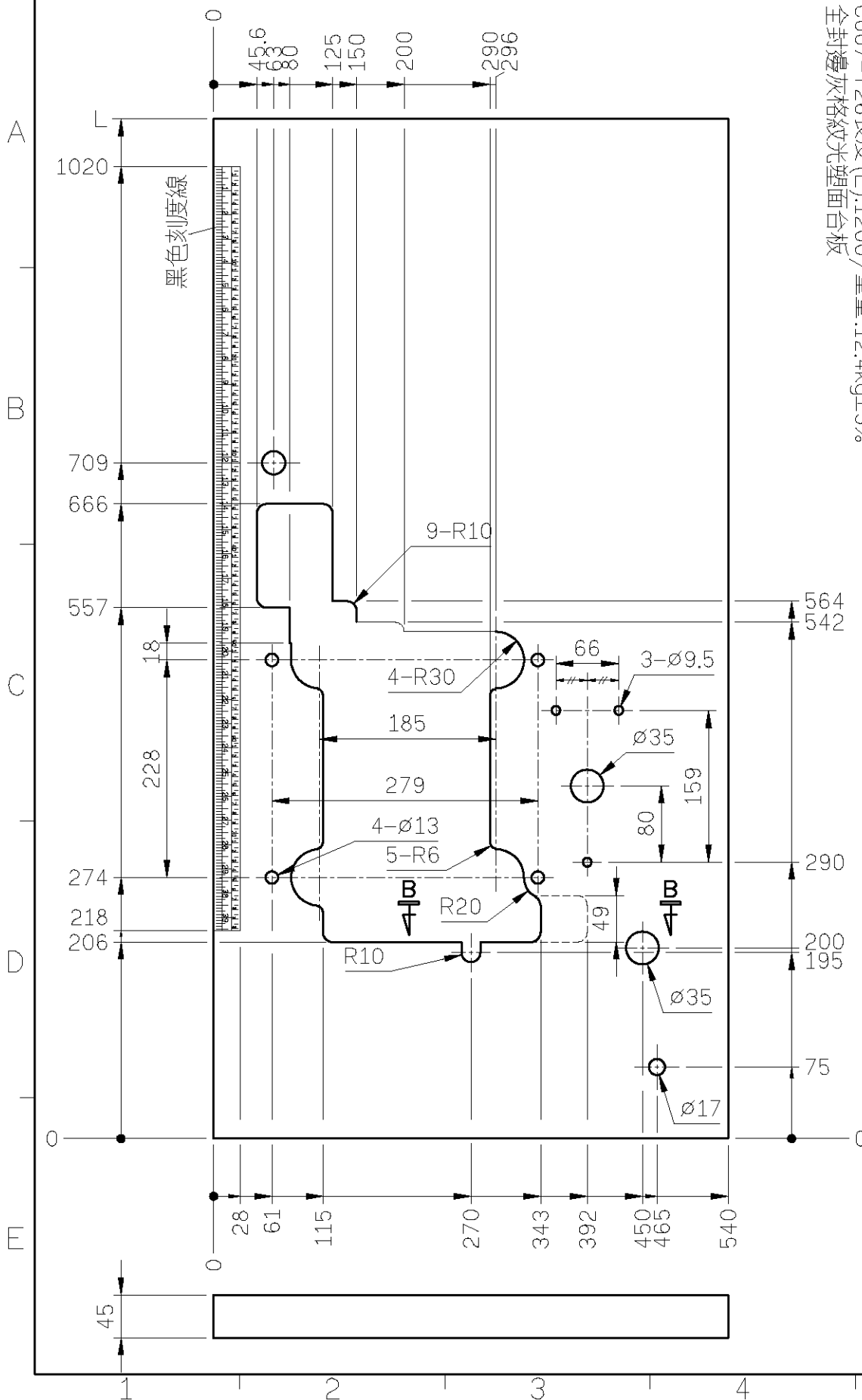

TABLE CUT-OUT OF C007-T30

三針筒車上乘桌板圖
 C007J SERIES TABLE CUT-OUT SEMI-SUBMERGED
 單位/UNIT:mm
 FOR 印度客戶使用
 所有尺寸公差/DIFFERENCE:±2
 C007-T30-1070長度(L):1070/重量:11.3kg±5%
 C007-T30長度(L):1200/重量:12.3kg±5%
 全封邊灰格紋光塑面台板

