

# SIRUBA®

銀箭牌工業用縫紉機

INDUSTRIAL SEWING MACHINE

# C007JD



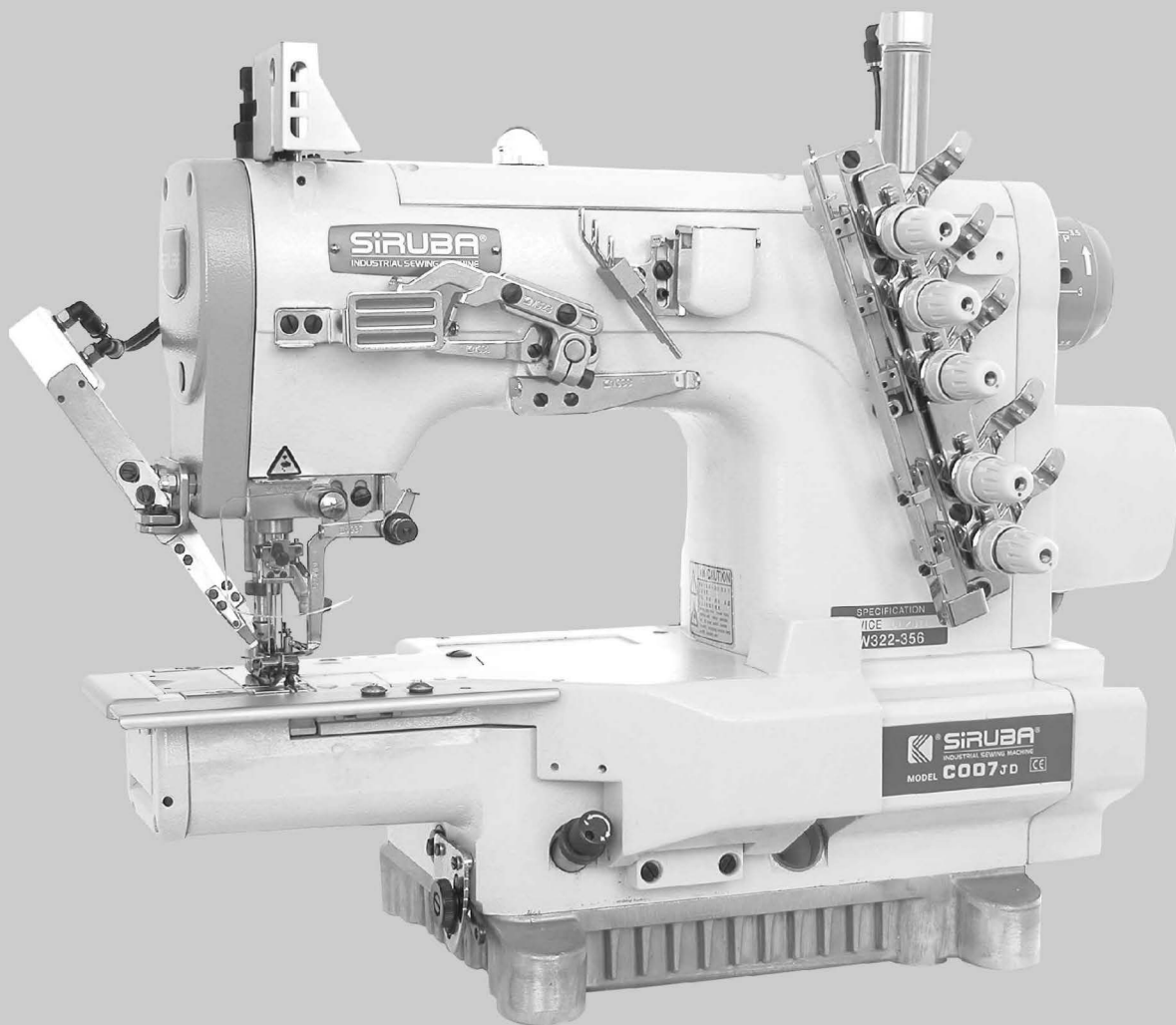



## 零件圖 PARTS LIST

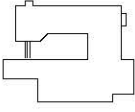

CE

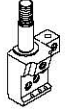
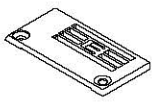
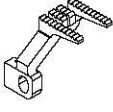
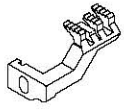
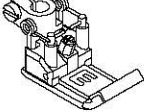

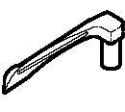
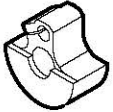

 高林股份有限公司  
KAULIN MFG. CO., LTD.

From the library of: Superior Sewing Machine & Supply LLC



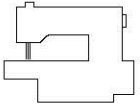

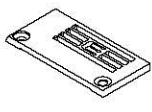
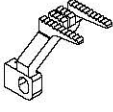
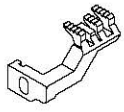
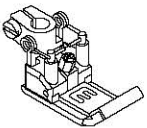
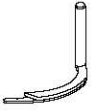
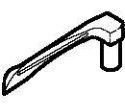
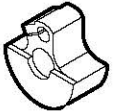

										
MODEL	SUB-CLASS	NEEDLE CLAMP	NEEDLE PLATE	MAIN FEED DOG	DIFF. FEED DOG	PRESSER FOOT	SPREADER	LOOPER	CAM	NEEDLE
機 型	規 格	針 座	針 板	主 送 具	差 送 具	押 具	上 叉	勾 針	偏 心 凸 輪	針 號
C007JD-W121 /CH	240 248 356 364	M5240 M5248 M5356 M5364	E 3514P E 3515P E 3836P E 3837P	D 4206 D 4206 D 4206 D 4207	H 4458 H 4458 H 4458 H 4459	P2544 P2545 P2446 P2447	MH41	MT01	MF01-A	UY128GAS #10
C007JD-U121 /CH	240 248 356 364	M5240 M5248 M5356 M5364	E 3514P E 3515P E 3836P E 3837P	D 4206 D 4206 D 4206 D 4207	H 4458 H 4458 H 4458 H 4459	P2544 P2545 P2446 P2447	—	MT01	MF01-A	UY128GAS #10
C007JD-W122 /CH	240 248 256 356 364	M5240 M5248 M5356 M5356 M5364	E 3524P E 3525P E 3826S E 3826P E 3827P	D 4206 D 4206 D 4206 D 4206 D 4207	H 4458 H 4458 H 4458 H 4458 H 4459	P2544 P2545 P2446 P2446 P2447	MH41	MT01	MF01-A	UY128GAS #10
C007JD-U122 /CH	240 248 256 356 364	M5240 M5248 M5356 M5356 M5364	E 3524P E 3525P E 3826S E 3826P E 3827P	D 4206 D 4206 D 4206 D 4206 D 4207	H 4458 H 4458 H 4458 H 4458 H 4459	P2544 P2545 P2446 P2446 P2447	—	MT01	MF01-A	UY128GAS #10
C007JD-W122 CH/UTP(UTR)	240 248 256 356 364	M5240 M5248 M5356 M5356 M5364	E 3524P E 3525P E 3826S E 3826P E 3827P	D 4206 D 4206 D 4206 D 4206 D 4207	H 4458 H 4458 H 4458 H 4458 H 4459	P2544 P2545 P2446 P2446 P2447	MH41	MT01	MF01-A	UY128GAS #10

註：P2544/2545 為固定式押具舌,亦可使用活動式押具舌 P2565代替P2544/P2545  
P2446/2447 為固定式押具舌,亦可使用活動式押具舌 P2466代替P2446/2447

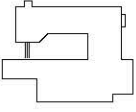
## 規格件表 CONVERSION CHART-2

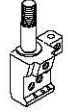
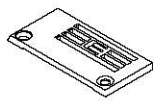
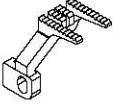
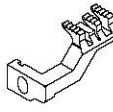
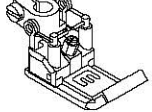

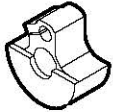

										
MODEL	SUB-CLASS	NEEDLE CLAMP	NEEDLE PLATE	MAIN FEED DOG	DIFF. FEED DOG	PRESSER FOOT	SPREADER	LOOPER	CAM	NEEDLE
機 型	規 格	針 座	針 板	主 送 具	差 送 具	押 具	上 叉	勾 針	偏 心 凸 輪	針 號
C007JD-U122 CH/UTQ(UTS)	240 248 256 356 364	M5240 M5248 M5356 M5356 M5364	E 3524P E 3525P E 3826S E 3826P E 3827P	D 4206 D 4206 D 4206 D 4206 D 4207	H 4458 H 4458 H 4458 H 4458 H 4459	P2544 P2545 P2446 P2446 P2447	—	MT01	MF01-A	UY128GAS #10
C007JD-W122 /CHA	356	M5356	E 3826Q	D 4206	H 4458	P0216	MH41	MT01	MF01-A	UY128GAS #10
C007JD-U122 /CHA	356	M5356	E 3826Q	D 4206	H 4458	P0416	—	MT01	MF01-A	UY128GAS #10
C007JD-W123 /CH	356 364	M5356 M5364	E 3816P E 3817P	D 4206 D 4207	H 4458 H 4459	P2446 P2447	MH41	MT01	MF01-A	UY128GAS #10
C007JD-U123 /CH	356 364	M5356 M5364	E 3816P E 3817P	D 4206 D 4207	H 4458 H 4459	P2446 P2447	—	MT01	MF01-A	UY128GAS #10
C007JD-W123 CH/UTP(UTR)	356 364	M5356 M5364	E 3816P E 3817P	D 4206 D 4207	H 4458 H 4459	P2446 P2447	MH41	MT01	MF01-A	UY128GAS #10
C007JD-U123 CH/UTQ(UTS)	356 364	M5356 M5364	E 3816P E 3817P	D 4206 D 4207	H 4458 H 4459	P2446 P2447	—	MT01	MF01-A	UY128GAS #10
C007JD-W132 /CHE	240 248 356 364	M5240 M5248 M5356 M5364	E 2324P E 2325P E 2326P E 2327P	D 2109 D 2109 D 2110 D 2110	H 2219 H 2219 H 2220 H 2220	P2904 P2905 P2906 P2907	MH41	MT01	MF01-A	UY128GAS #10
C007JD-W132 CHE/UTP(UTR)	356 364	M5356 M5364	E 2326P E 2327P	D 2110	H 2220	P2906 P2907	MH41	MT01	MF01-A	UY128GAS #10

註：P2544/2545 為固定式押具舌,亦可使用活動式押具舌 P2565代替P2544/P2545  
P2446/2447 為固定式押具舌,亦可使用活動式押具舌 P2466代替P2446/2447



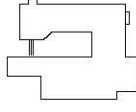

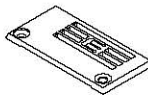
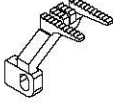
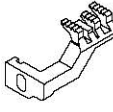
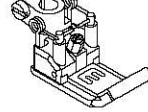
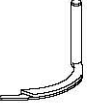
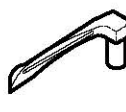
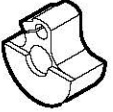
										
MODEL	SUB-CLASS	NEEDLE CLAMP	NEEDLE PLATE	MAIN FEED DOG	DIFF. FEED DOG	PRESSER FOOT	SPREADER	LOOPER	CAM	NEEDLE
機 型	規 格	針 座	針 板	主 送 具	差 送 具	押 具	上 叉	勾 針	偏 心 凸 輪	針 號
C007JD-W152 /CZP/RLQ	356 364	M5356 M5364	E4326 E4327	D 3216 D 3217	H 3262 H 3263	P2416 P2417	MH41	MT01	MF01-A	UY128GAS #10
C007JD-U152 /CZP/RLQ	356 364	M5356 M5364	E4326 E4327	D 3216 D 3217	H 3262 H 3263	P2416 P2417	—	MT01	MF01-A	UY128GAS #10
C007JD-W152 CZP/CLA/RLQ	356 364	M5356 M5364	E4326 E4327	D 3216 D 3217	H 3262 H 3263	P2416 P2417	MH41	MT01	MF01-A	UY128GAS #10
C007JD-U152 CZP/CLA/RLQ	356 364	M5356 M5364	E4326 E4327	D 3216 D 3217	H 3262 H 3263	P2416 P2417	—	MT01	MF01-A	UY128GAS #10
C007JD-W162	240 248 356 364	M5240 M5248 M5356 M5364	E3544 E3545 E3846 E3847	D4206 D4206 D4206 D4207	H4458 H4458 H4458 H4459	P2544 P2545 P2446 P2447	MH41	MT01A	MF91-A	UY128GAS #14~16
C007JD-U162	240 248 356 364	M5240 M5248 M5356 M5356	E3544 E3545 E3846 E3847	D4206 D4206 D4206 D4207	H4458 H4458 H4458 H4459	P2544 P2545 P2446 P2447	—	MT01A	MF91-A	UY128GAS #14~16
C007JD-W162 /UTP (UTR)	240 248 356 364	M5240 M5248 M5356 M5364	E3544 E3545 E3846 E3847	D4206 D4206 D4206 D4207	H4458 H4458 H4458 H4459	P2544 P2545 P2446 P2447	MH41	MT01A	MF91-A	UY128GAS #14~16
C007JD-U162 /UTQ (UTS)	240 248 356 364	M5240 M5248 M5356 M5356	E3544 E3545 E3846 E3847	D4206 D4206 D4206 D4207	H4458 H4458 H4458 H4459	P2544 P2545 P2446 P2447	—	MT01A	MF01-A	UY128GAS #14~16

註：P2544/2545 為固定式押具舌,亦可使用活動式押具舌 P2565代替P2544/P2545  
P2446/2447 為固定式押具舌,亦可使用活動式押具舌 P2466代替P2446/2447

## 規格件表 CONVERSION CHART-4

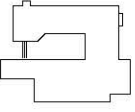
										
MODEL	SUB-CLASS	NEEDLE CLAMP	NEEDLE PLATE	MAIN FEED DOG	DIFF. FEED DOG	PRESSER FOOT	SPREADER	LOOPER	CAM	NEEDLE
機 型	規 格	針 座	針 板	主 送 具	差 送 具	押 具	上 叉	勾 針	偏 心 凸 輪	針 號
C007JD-W222 /CQ	240 248	M5240 M5248	E 4124P E 4125P	D 3216 D 3216	H 3362 H 3362	P1814 P 1815	MH41	MT01	MF01-A	UY128GAS #10
C007JD-U222 /CQ	356 364	M5356 M5364	E 4426P E 4427P	D 3216 D 3217	H 3362 H 3363	P2116 P2117	—			
C007JD-W222 /CQA/CLA	256	M5356	E2326Q	D2110	H2220Q	P2906Q	MH41	MT01A	MF91-A	TV*5 #14
C007JD-W222 /CQB/CC	248 356 364	M5248 M5356 M5364	E 4125P E 4426P E 4427P	D 3216 D 3216 D 3217	H 3362 H 3362 H 3363	P 1815 P2116 P2117	MH41	MT01	MF01-A	UY128GAS #10
C007JD-W222 /CQB/CD										
C007JD-W222 /CQB/CE										
C007JD-U222 /CQB/CC	248 356 364	M5248 M5356 M5356	E 4125P E 4426P E 4427P	D 3216 D 3216 D 3217	H 3362 H 3362 H 3363	P 2315 P2616 P2617	—	MT01	MF01-A	UY128GAS #10
C007JD-U222 /CQB/CD										
C007JD-U222 /CQB/CE										
C007JD-W322 /CC	356 364	M5356 M5364	E 2826P E 2827P	D 2107L D 2107L	H 3259M H 3259M	P2456 P2457	MH41	MT01	MF01-A	UY128GAS #10
C007JD-U322 /CC	356 364	M5356 M5364	E 2826P E 2827P	D 2107L D 2107L	H 3259M H 3259M	P2456 P2457	—	MT01	MF01-A	UY128GAS #10
C007JD-W322 CC/UTP(UTR)	356 364	M5356 M5364	E 2826P E 2827P	D 2107L D 2107L	H 3259M H 3259M	P2456 P2457	MH41	MT01	MF01-A	UY128GAS #10
C007JD-U322 CC/UTQ(UTS)	356 364	M5356 M5364	E 2826P E 2827P	D 2107L D 2107L	H 3259M H 3259M	P2456 P2457	—	MT01	MF01-A	UY128GAS #10

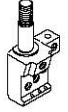
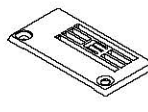
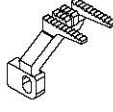
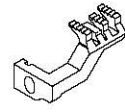
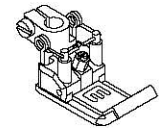
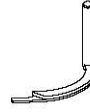
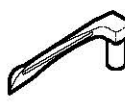
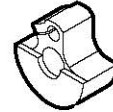
\*CQB為三合一機型 註：P2544/2545 為固定式押具舌,亦可使用活動式押具舌 P2565代替P2544/P2545  
 P2446/2447 為固定式押具舌,亦可使用活動式押具舌 P2466代替P2446/2447







										
MODEL	SUB-CLASS	NEEDLE CLAMP	NEEDLE PLATE	MAIN FEED DOG	DIFF. FEED DOG	PRESSER FOOT	SPREADER	LOOPER	CAM	NEEDLE
機 型	規 格	針 座	針 板	主 送 具	差 送 具	押 具	上 叉	勾 針	偏 心 凸 輪	針 號
C007JD-W322 /CD	356 364	M5356 M5364	E 3626P E 3627P	D 4206 D 4207	H 4158 H 4159	P2446 P2447	MH41	MT01	MF01-A	UY128GAS #10
C007JD-U322 /CD	356 364	M5356 M5364	E 3626P E 3627P	D 4206 D 4207	H 4158 H 4159	P2446 P2447	—	MT01	MF01-A	UY128GAS #10
C007JD-W322 CD/UTP(UTR)	356 364	M5356 M5364	E 3626P E 3627P	D 4206 D 4207	H 4158 H 4159	P2446 P2447	MH41	MT01	MF01-A	UY128GAS #10
C007JD-U322 CD/UTQ(UTS)	356 364	M5356 M5364	E 3626P E 3627P	D 4206 D 4207	H 4158 H 4159	P2446 P2447	—	MT01	MF01-A	UY128GAS #10
C007JD-W322 /CE	356 364	M5356 M5364	E 2626P E 2627P	D 2107	H 3159	P2456 P2457	MH41	MT01	MF01-A	UY128GAS #10
C007JD-U322 /CE	356 364	M5356 M5364	E 2626P E 2627P	D 2107	H 3159	P2456 P2457	—	MT01	MF01-A	UY128GAS #10
C007JD-W322 CE/UTP(UTR)	356 364	M5356 M5364	E 2626P E 2627P	D 2107	H 3159	P2456 P2457	MH41	MT01	MF01-A	UY128GAS #10
C007JD-U322 CE/UTQ(UTS)	356 364	M5356 M5364	E 2626P E 2627P	D 2107	H 3159	P2456 P2457	—	MT01	MF01-A	UY128GAS #10
C007JD-U322 /CF	248	M5348	E 2625P	D 2106	H 3158	P2555P	—	MT01	MF01-A	UY128GAS #10
C007JD-U322 CF/UTQ(UTS)	248	M5348	E 2625P	D 2106	H 3158	P2555P	—	MT01	MF01-A	UY128GAS #10

註：P2544/2545 為固定式押具舌,亦可使用活動式押具舌 P2565代替P2544/P2545  
P2446/2447 為固定式押具舌,亦可使用活動式押具舌 P2466代替P2446/2447

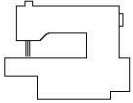
## 規格件表 CONVERSION CHART-6

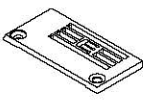
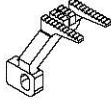
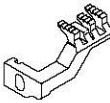
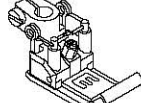
										
MODEL	SUB-CLASS	NEEDLE CLAMP	NEEDLE PLATE	MAIN FEED DOG	DIFF. FEED DOG	PRESSER FOOT	SPREADER	LOOPER	CAM	NEEDLE
機 型	規 格	針 座	針 板	主 送 具	差 送 具	押 具	上 叉	勾 針	偏 心 凸 輪	針 號
C007JD-W512 /FE	240 356 364	M5240 M5356 M5364	E 3524R E 3826R E 3827R	D 4206 D 4206 D 4207	H 4458 H 4458 H 4459	P2914 P3216 P3217	MH41	MT01	MF01-A	UY128GAS #10
C007JD-U512 /FE	240 356 364	M5240 M5356 M5364	E 3524R E 3826R E 3827R	D 4206 D 4206 D 4207	H 4458 H 4458 H 4459	P3414 P3716 P3717	—	MT01	MF01-A	UY128GAS #10
C007JD-W522 /FE/CR/CL	356 364	M5356 M5364	E 6426R E 6427R	D 3222	H 3268	P3816R P3817R	MH41	MT01	MF01-A	UY128GAS #10
C007JD-U522 /FE/CR/CL	356 364	M5356 M5364	E 6426R E 6427R	D 3222	H 3268	P3816R P3817R	—	MT01	MF01-A	UY128GAS #10
C007JD-W532/ CR/UTP/CL/RLP/CX	356 364	M5356 M5364	E 6426R E 6427R	D 3222	H 3268	P3816R P3817R	MH41	MT01	MF01-A	UY128GAS #10
C007JD-U532/ CR/UTQ/CL/RLP/CX	356 364	M5356 M5364	E 6426R E 6427R	D 3222	H 3268	P3816R P3817R	MH41	MT01	MF01-A	UY128GAS #10
C007J-W922/ CW	456 464	M5456 M5464	E1828P E1848P	D2107M	H4459M	P2428P P2448P	MH41	MT01B	MF01-A	SM1014B#10 (MY1014B#70,SY7256)

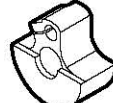





註：C007JD不可加裝 FFC

										
MODEL	SUB-CLASS	NEEDLE CLAMP	NEEDLE PLATE	MAIN FEED DOG	DIFF. FEED DOG	PRESSER FOOT	SPREADER	LOOPER	CAM	NEEDLE
機 型	規 格	針 座	針 板	主 送 具	差 送 具	押 具	上 叉	勾 針	偏 心 凸 輪	針 號
C007JD-W811 /CRL/RL	248 356 364	M5248 M5356 M5364	E 0235R E 0236R E 0237R	D2101Q	H2203R	P2765 P2766 P2767	MH41	MT01	MF91-A	UY128GAS #10
C007JD-W811A /CRL/RL	248 356 364	M5248 M5356 M5364	E 0235Q E 0236Q E 0237Q	D2101Q	H2203Q	P2765 P2766 P2767	MH41	MT01	MF91-A	UY128GAS #10
C007JD-U811 /CRL/RL	248 356 364	M5248 M5356 M5364	E 0235R E 0236R E 0237R	D2101Q	H2203R	P0965 P0966 P0967	—	MT01	MF91-A	UY128GAS #10
C007JD-U811A /CRL/RL	248 356 364	M5248 M5356 M5364	E 0235Q E 0236Q E 0237Q	D2101Q	H2203Q	P0965 P0966 P0967	—	MT01	MF91-A	UY128GAS #10
C007JD-W812 /CRL/RL	248 356 364	M5248 M5356 M5364	E 0225R E 0226R E 0227R	D2101Q	H2203R	P2765 P2766 P2767	MH41	MT01	MF91-A	UY128GAS #10
C007JD-W812A /CRL/RL	248 356 364	M5248 M5356 M5364	E 0225Q E 0226Q E 0227Q	D2101Q	H2203Q	P2765 P2766 P2767	MH41	MT01	MF91-A	UY128GAS #10
C007JD-U812 /CRL/RL	248 356 364	M5248 M5356 M5364	E 0225R E 0226R E 0227R	D2101Q	H2203R	P0965 P0966 P0967	—	MT01	MF91-A	UY128GAS #10
C007JD-U812A /CRL/RL	248 356 364	M5248 M5356 M5364	E 0225Q E 0226Q E 0227Q	D2101Q	H2203Q	P0966 P0967	—	MT01	MF91-A	UY128GAS #10
C007JD-W812 CRL/UTP/RL	248 356 364	M5248 M5356 M5364	E 0225R E 0226R E 0227R	D2101Q	H2203R	P2765 P2766 P2767	MH41	MT01	MF91-A	UY128GAS #10
C007JD-W812A CRL/UTP/RL	248 356 364	M5248 M5356 M5364	E 0225Q E 0226Q E 0227Q	D2101Q	H2203Q	P2765 P2766 P2767	MH41	MT01	MF91-A	UY128GAS #10
C007JD-U812 CRL/UTQ/RL	248 356 364	M5248 M5356 M5364	E 0225R E 0226R E 0227R	D2101Q	H2203R	P0965 P0966 P0967	—	MT01	MF91-A	UY128GAS #10
C007JD-U812A CRL/UTQ/RL	248 356 364	M5248 M5356 M5364	E 0225Q E 0226Q E 0227Q	D2101Q	H2203Q	P0965 P0966 P0967	—	MT01	MF91-A	UY128GAS #10

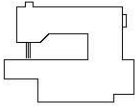

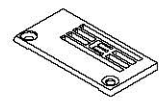
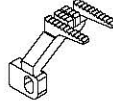
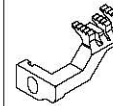
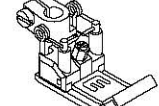

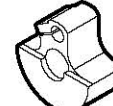

註：C007JD-W812A/W813A 機型之針板與差送具為5排齒。 C007JD-W812/W813 機型之針板與差送具為4排齒。

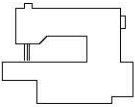

## 規格件表 CONVERSION CHART-8

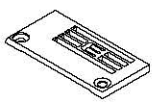
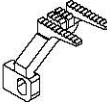
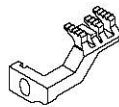
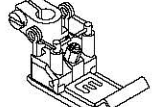

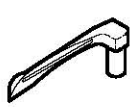
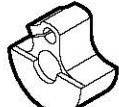



										
MODEL	SUB-CLASS	NEEDLE CLAMP	NEEDLE PLATE	MAIN FEED DOG	DIFF. FEED DOG	PRESSER FOOT	SPREADER	LOOPER	CAM	NEEDLE
機型	規格	針座	針板	主送具	差送具	押具	上叉	勾針	偏心凸輪	針號
C007JD-W812 /CRL/UTR/CSB	248 356 364	M5248 M5356 M5364	E 0225R E 0226R E 0227R	D2101Q	H2203R	P2765 P2766 P2767	MH41	MT01	MF91-A	UY128GAS #10
C007JD-W812A /CRL/UTR/CSB	248 356 364	M5248 M5356 M5364	E 0225Q E 0226Q E 0227Q	D2101Q	H2203Q	P2765 P2766 P2767	MH41	MT01	MF91-A	UY128GAS #10
C007JD-U812 /CRL/UTS/CSB	248 356 364	M5248 M5356 M5364	E 0225R E 0226R E 0227R	D2101Q	H2203R	P0965 P0966 P0967	MH41	MT01	MF91-A	UY128GAS #10
C007JD-U812A /CRL/UTS/CSB	248 356 364	M5248 M5356 M5364	E 0225Q E 0226Q E 0227Q	D2101Q	H2203Q	P0965 P0966 P0967	MH41	MT01	MF91-A	UY128GAS #10
C007JD-W813 /CRL/RL	248 356 364	M5248 M5356 M5364	E 0215R E 0216R E 0217R	D2101Q	H2203R	P2765 P2766 P2767	MH41	MT01	MF91-A	UY128GAS #10
C007JD-W813A /CRL/RL	248 356 364	M5248 M5356 M5364	E 0215Q E 0216Q E 0217Q	D2101Q	H2203Q	P2765 P2766 P2767	MH41	MT01	MF91-A	UY128GAS #10
C007JD-U813 /CRL/RL	248 356 364	M5248 M5356 M5364	E 0215R E 0216R E 0217R	D2101Q	H2203R	P0965 P0966 P0967	—	MT01	MF91-A	UY128GAS #10
C007JD-U813A /CRL/RL	248 356 364	M5248 M5356 M5364	E 0215Q E 0216Q E 0217Q	D2101Q	H2203Q	P0965 P0966 P0967	—	MT01	MF91-A	UY128GAS #10
C007JD-W813 CRL/UTP/RL	248 356 364	M5248 M5356 M5364	E 0215R E 0216R E 0217R	D2101Q	H2203R	P2765 P2766 P2767	MH41	MT01	MF91-A	UY128GAS #10
C007JD-W813A CRL/UTP/RL	248 356 364	M5248 M5356 M5364	E 0215Q E 0216Q E 0217Q	D2101Q	H2203Q	P2765 P2766 P2767	MH41	MT01	MF91-A	UY128GAS #10
C007JD-U813 CRL/UTQ/RL	248 356 364	M5248 M5356 M5364	E 0215R E 0216R E 0217R	D2101Q	H2203R	P0965 P0966 P0967	—	MT01	MF91-A	UY128GAS #10
C007JD-U813A CRL/UTQ/RL	248 356 364	M5248 M5356 M5364	E 0215Q E 0216Q E 0217Q	D2101Q	H2203Q	P0965 P0966 P0967	—	MT01	MF91-A	UY128GAS #10

註：C007JD-W812A/W813A 機型之針板與差送具為5排齒， C007JD-W812/W813 機型之針板與差送具為4排齒。

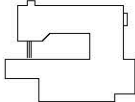
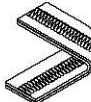
										
MODEL	SUB-CLASS	NEEDLE CLAMP	NEEDLE PLATE	MAIN FEED DOG	DIFF. FEED DOG	PRESSER FOOT	SPREADER	LOOPER	CAM	NEEDLE
機型	規格	針座	針板	主送具	差送具	押具	上叉	勾針	偏心凸輪	針號
C007JD-W813 /CRL/UTR/CSB	248 356 364	M5248 M5356 M5364	E0235R E0236R E0237R	D2101Q	H2203R	P2765 P2766 P2767	MH41	MT01	MF91-A	UY128GAS #10
C007JD-W813A /CRL/UTR/CSB	248 356 364	M5248 M5356 M5364	E0235Q E0236Q E0237Q	D2101Q	H2203Q	P2765 P2766 P2767	MH41	MT01	MF91-A	UY128GAS #10
C007JD-U813 /CRL/UTS/CSB	248 356 364	M5248 M5356 M5364	E0235R E0236R E0237R	D2101Q	H2203R	P0965 P0966 P0967	MH41	MT01	MF91-A	UY128GAS #10
C007JD-U813A /CRL/UTS/CSB	248 356 364	M5248 M5356 M5364	E0235Q E0236Q E0237Q	D2101Q	H2203Q	P0965 P0966 P0967	MH41	MT01	MF91-A	UY128GAS #10
C007JD-W822 /CRL/CY/CL/RL	248 356 364	M5248 M5356 M5364	E0225R E0226R E0227R	D2101Q	H2203R	P2765 P2766 P2767	MH41	MT01	MF91-A	UY128GAS #10
C007JD-W823 /CRL/CY/CL/RL	248 356 364	M5248 M5356 M5364	E0235R E0236R E0237R	D2101Q	H2203R	P2765 P2766 P2767	MH41	MT01	MF91-A	UY128GAS #10
C007JD-U822 /CRL/CY/CL/RL	248 356 364	M5248 M5356 M5364	E0225R E0226R E0227R	D2101Q	H2203R	P0965 P0966 P0967	—	MT01	MF91-A	UY128GAS #10
C007JD-U823 /CRL/CY/CL/RL	248 356 364	M5248 M5356 M5364	E0235R E0236R E0237R	D2101Q	H2203R	P0965 P0966 P0967	—	MT01	MF91-A	UY128GAS #10
C007JD-W822 CRL/CY/UTP/CL/RL	248 356 364	M5248 M5356 M5364	E0225R E0226R E0227R	D2101Q	H2203R	P2765 P2766 P2767	MH41	MT01	MF91-A	UY128GAS #10
C007JD-W823 CRL/CY/UTP/CL/RL	248 356 364	M5248 M5356 M5364	E0235R E0236R E0237R	D2101Q	H2203R	P2765 P2766 P2767	MH41	MT01	MF91-A	UY128GAS #10

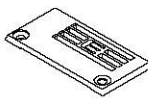
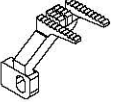
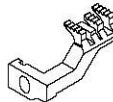
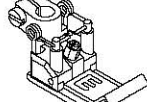
註：C007JD-W812A/W813A 機型之針板與差送具為5排齒。  
C007JD-W812/W813 機型之針板與差送具為4排齒。

## 規格件表 CONVERSION CHART-10

										
MODEL	SUB-CLASS	NEEDLE CLAMP	NEEDLE PLATE	MAIN FEED DOG	DIFF. FEED DOG	PRESSER FOOT	SPREADER	LOOPER	CAM	NEEDLE
機 型	規 格	針 座	針 板	主 送 具	差 送 具	押 具	上 叉	勾 針	偏 心 凸 輪	針 號
C007JD-U822 CRL/CY/UTQ/CL/RL	248 356 364	M5248 M5356 M5364	E0225R E0226R E0227R	D2101Q	H2203R	P0965 P0966 P0967	—	MT01	MF91-A	UY128GAS #10
C007JD-U823 CRL/CY/UTQ/CL/RL	248 356 364	M5248 M5356 M5364	E0235R E0236R E0237R	D2101Q	H2203R	P0965 P0966 P0967	—	MT01	MF91-A	UY128GAS #10
C007JD-U822 CRL/CY/UTQ/CL/RL	248 356 364	M5248 M5356 M5364	E0225R E0226R E0227R	D2101Q	H2203R	P0965 P0966 P0967	—	MT01	MF91-A	UY128GAS #10
C007JD-U823 CRL/CY/UTQ/CL/RL	248 356 364	M5248 M5356 M5364	E0235R E0236R E0237R	D2101Q	H2203R	P0965 P0966 P0967	—	MT01	MF91-A	UY128GAS #10

註：C007J-W/U122A-<sup>356</sup><sub>364</sub> /CH 時，增加 CE04-A

C007JD-W/U322A-<sup>356</sup><sub>364</sub> /CC 時，該針板與送金改用 C007JD-W/U122-<sup>356</sup><sub>364</sub> 之針板與送金



# PARTS LIST FOR MH GROUP

# PARTS LIST FOR MJ GROUP

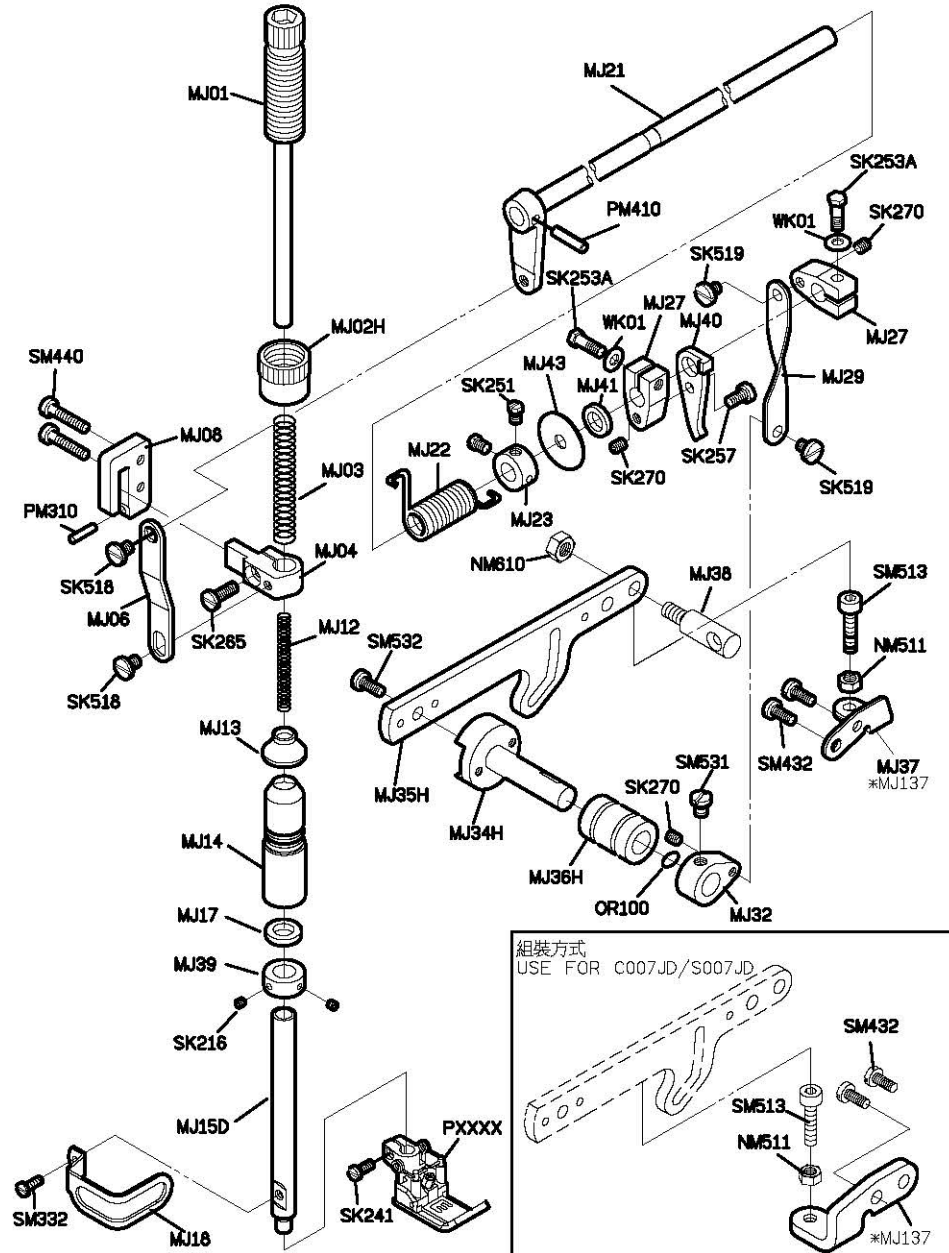
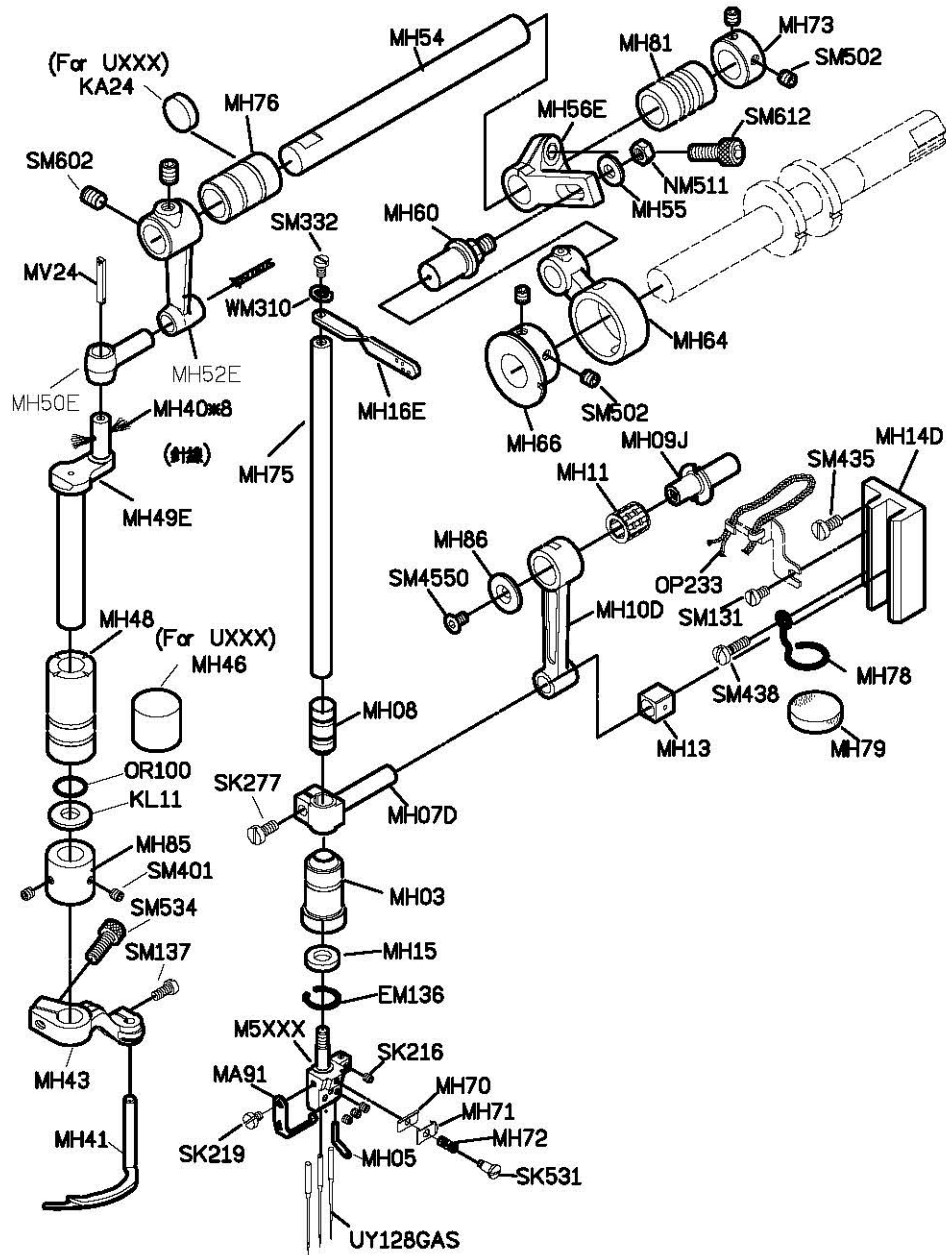

KX05

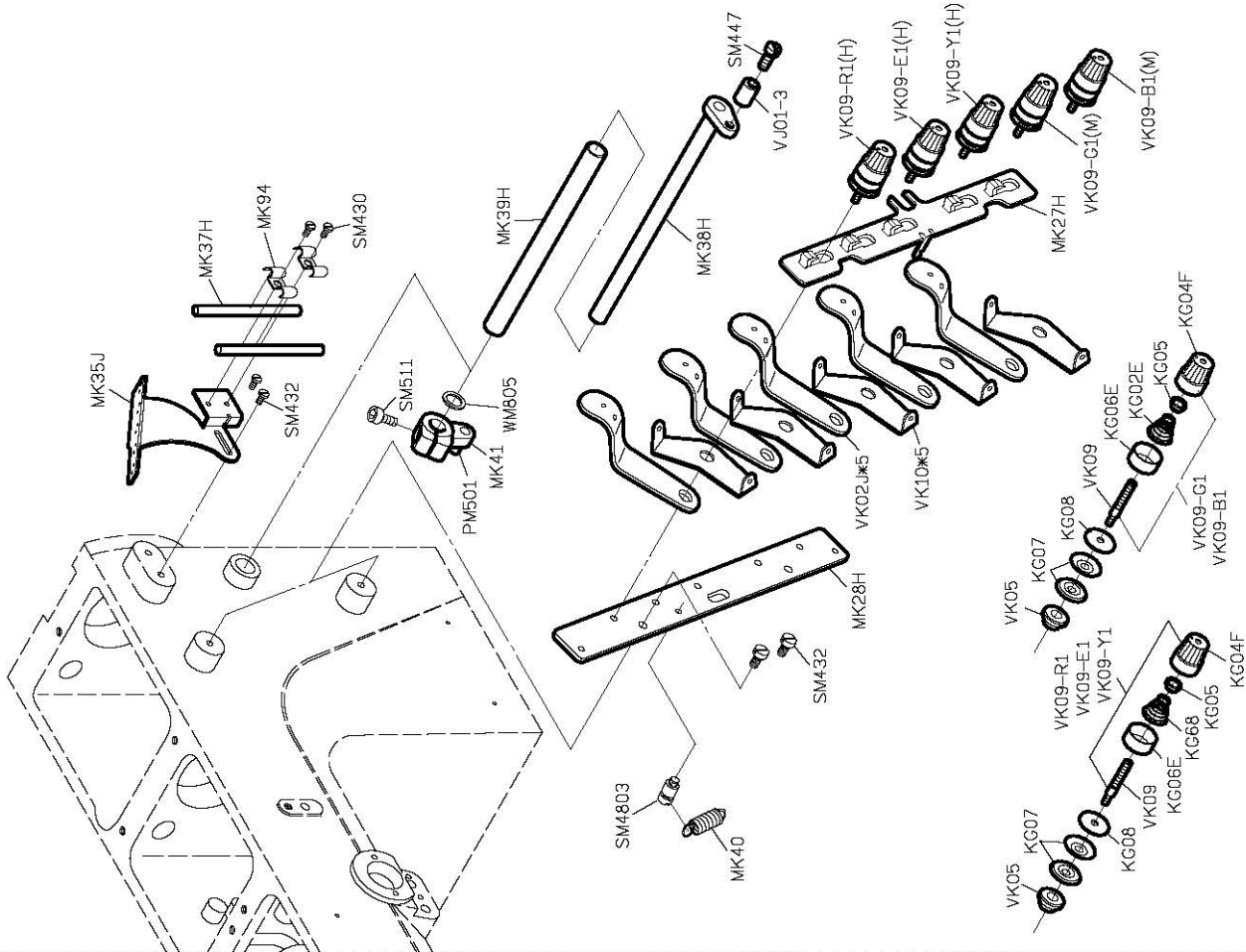
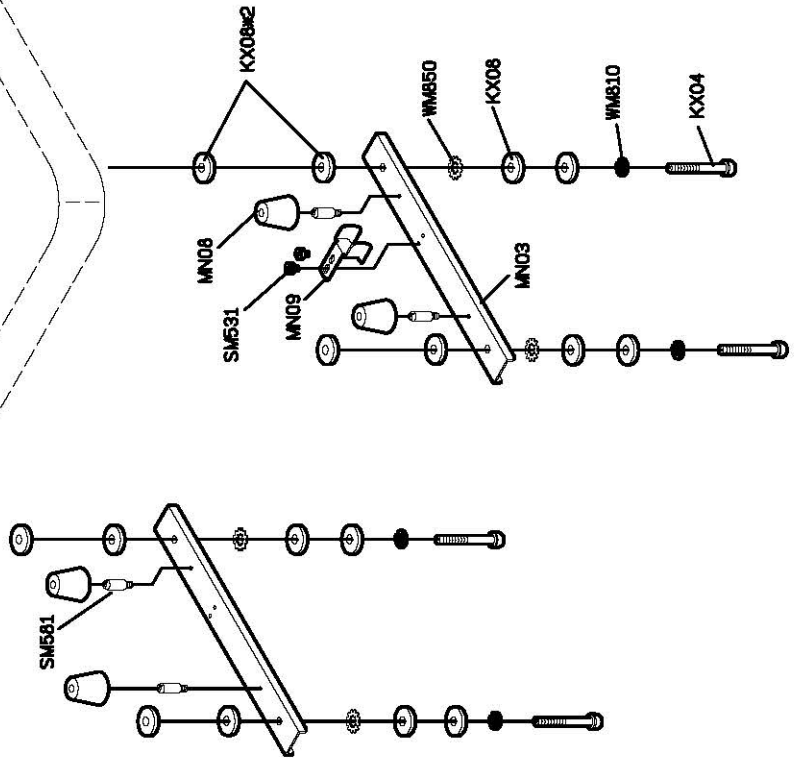
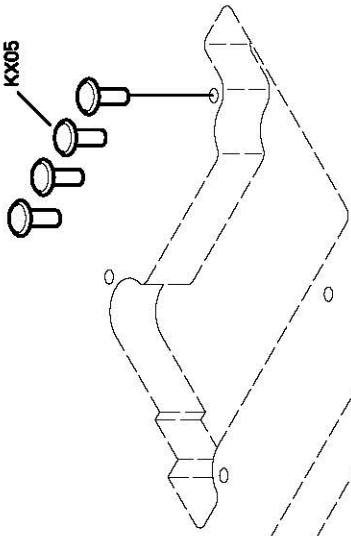

PARTS LIST FOR MN GROUP

PARTS LIST FOR MK GROUP







# PARTS LIST FOR MT GROUP

# PARTS LIST FOR MU GROUP

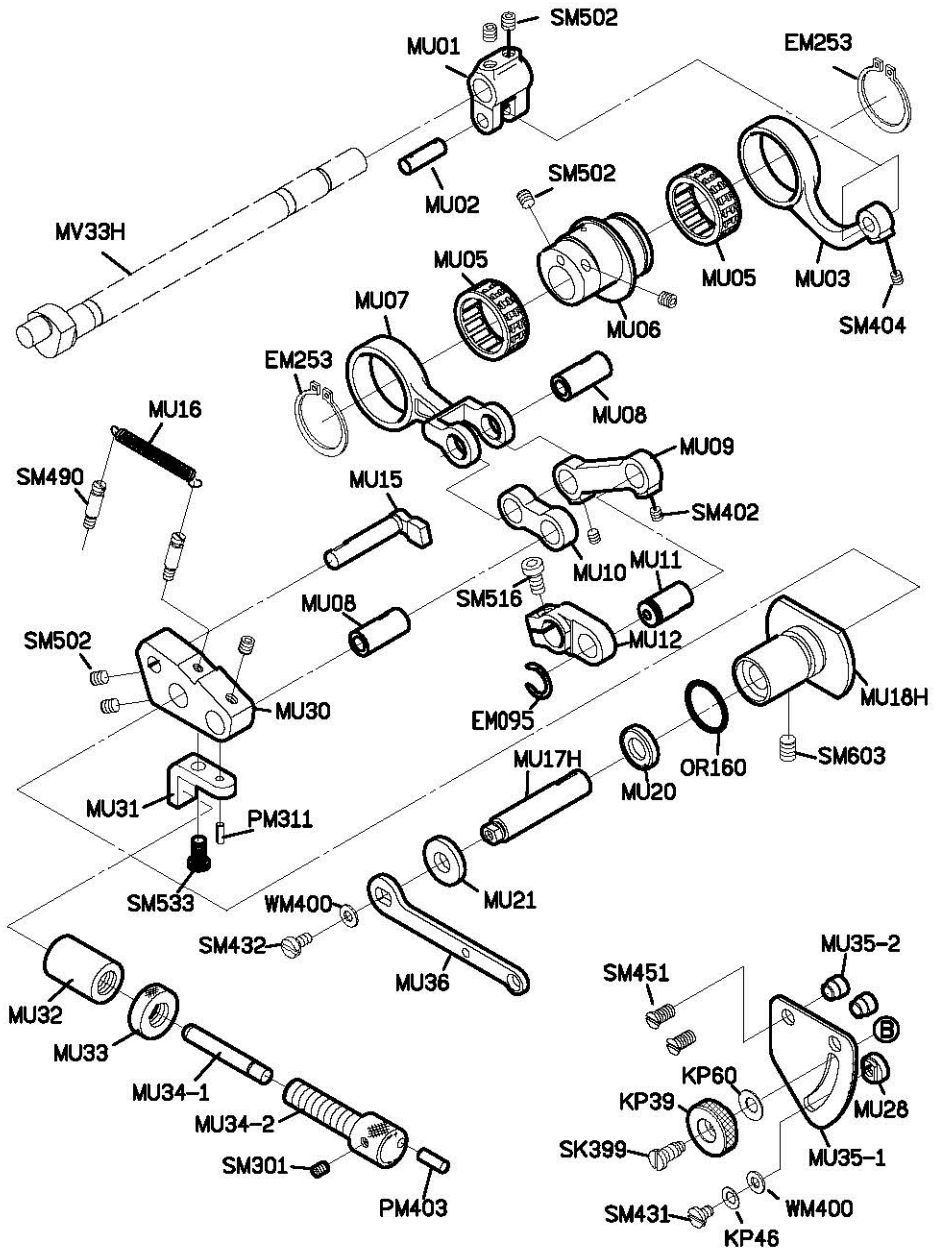
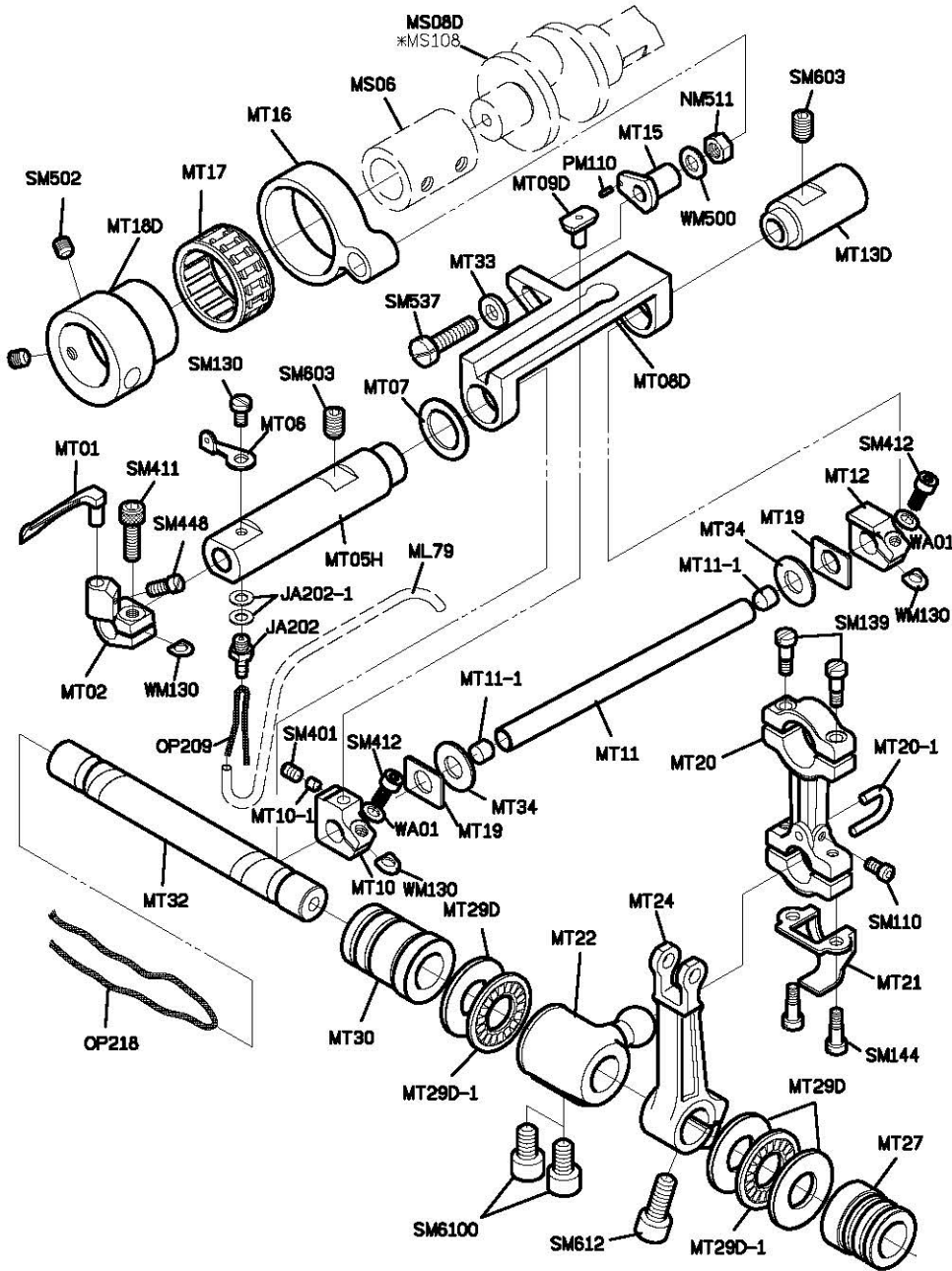

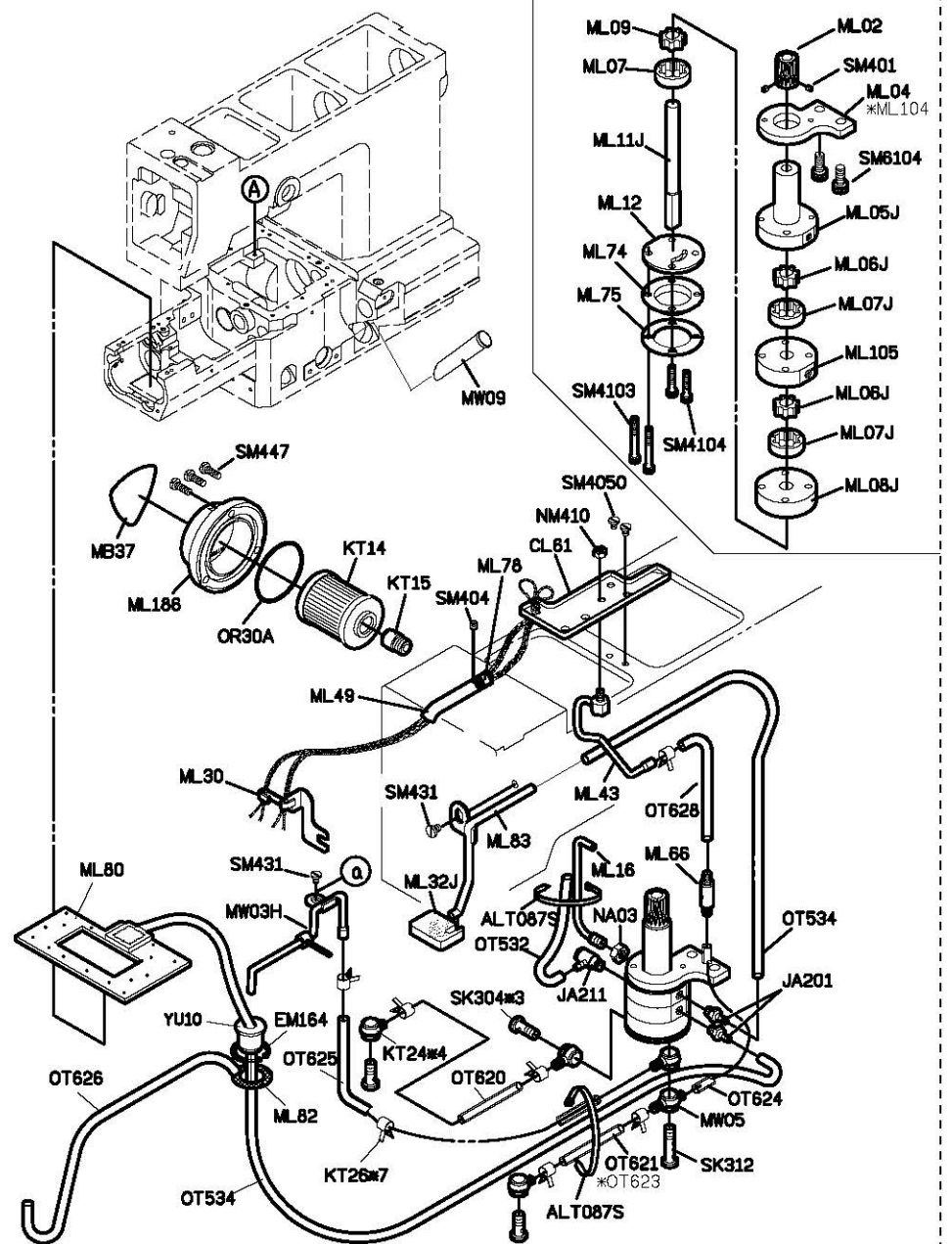
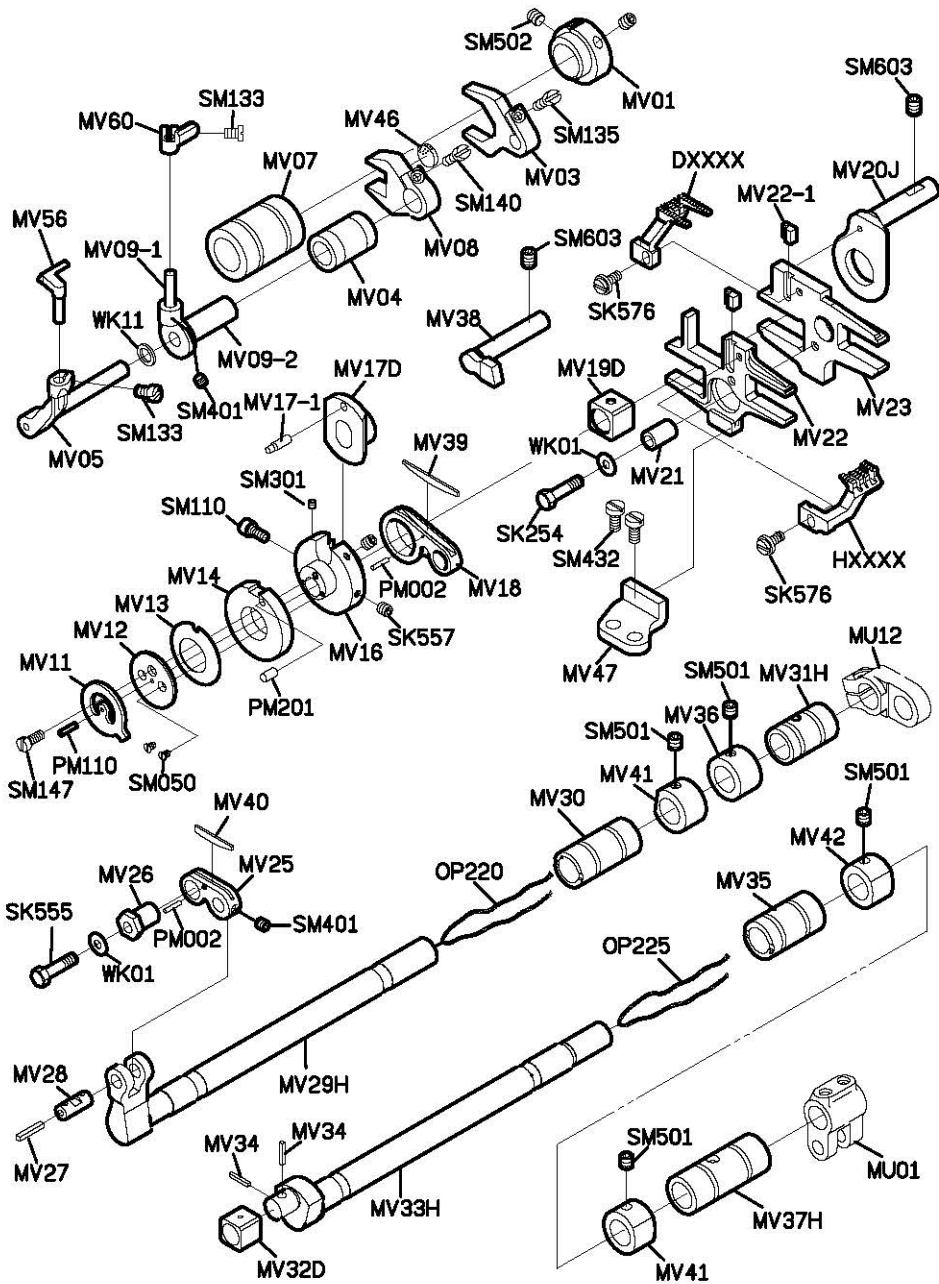

# PARTS LIST FOR MY GROUP

# PARTS LIST FOR MZ GROUP

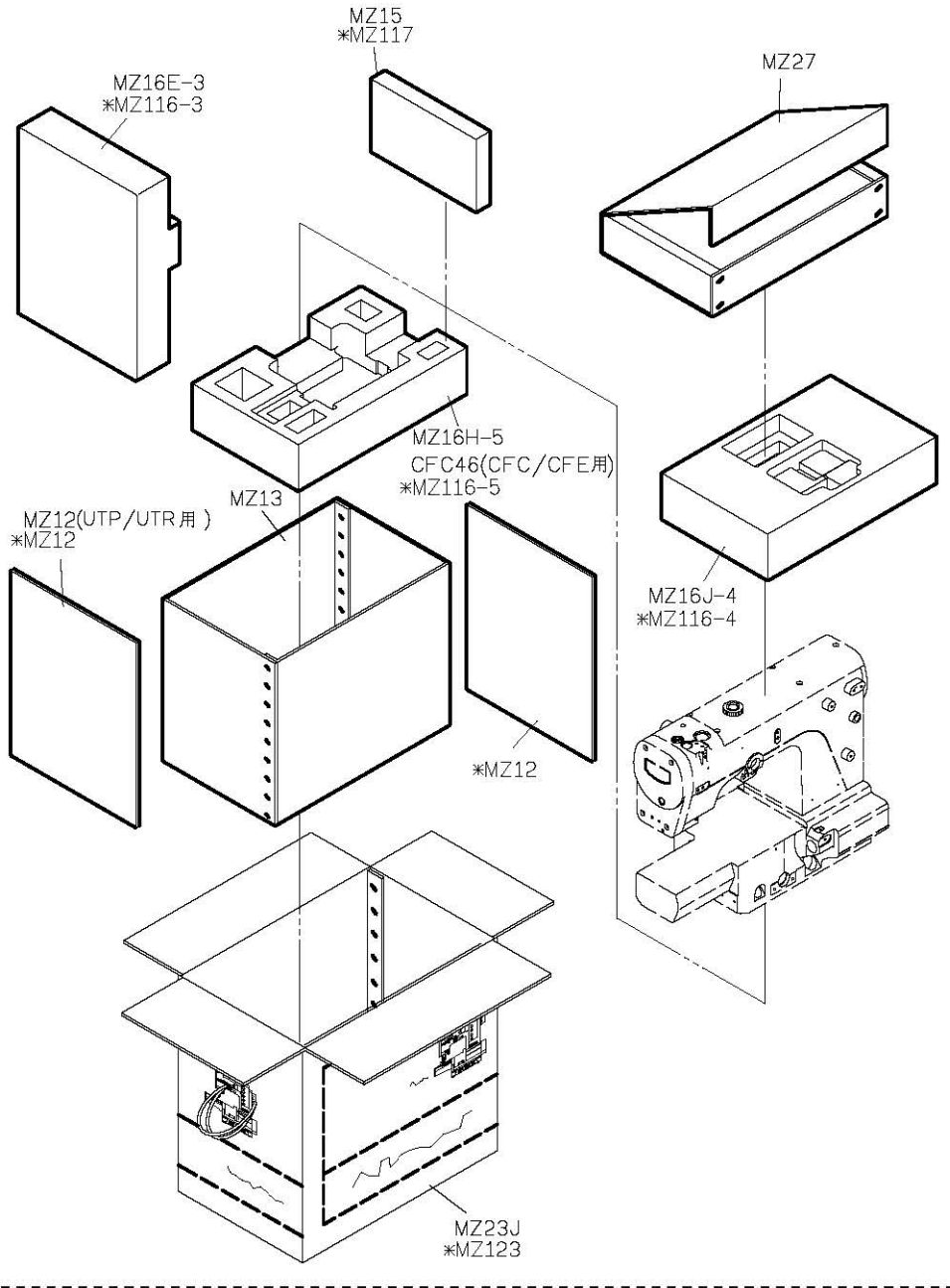
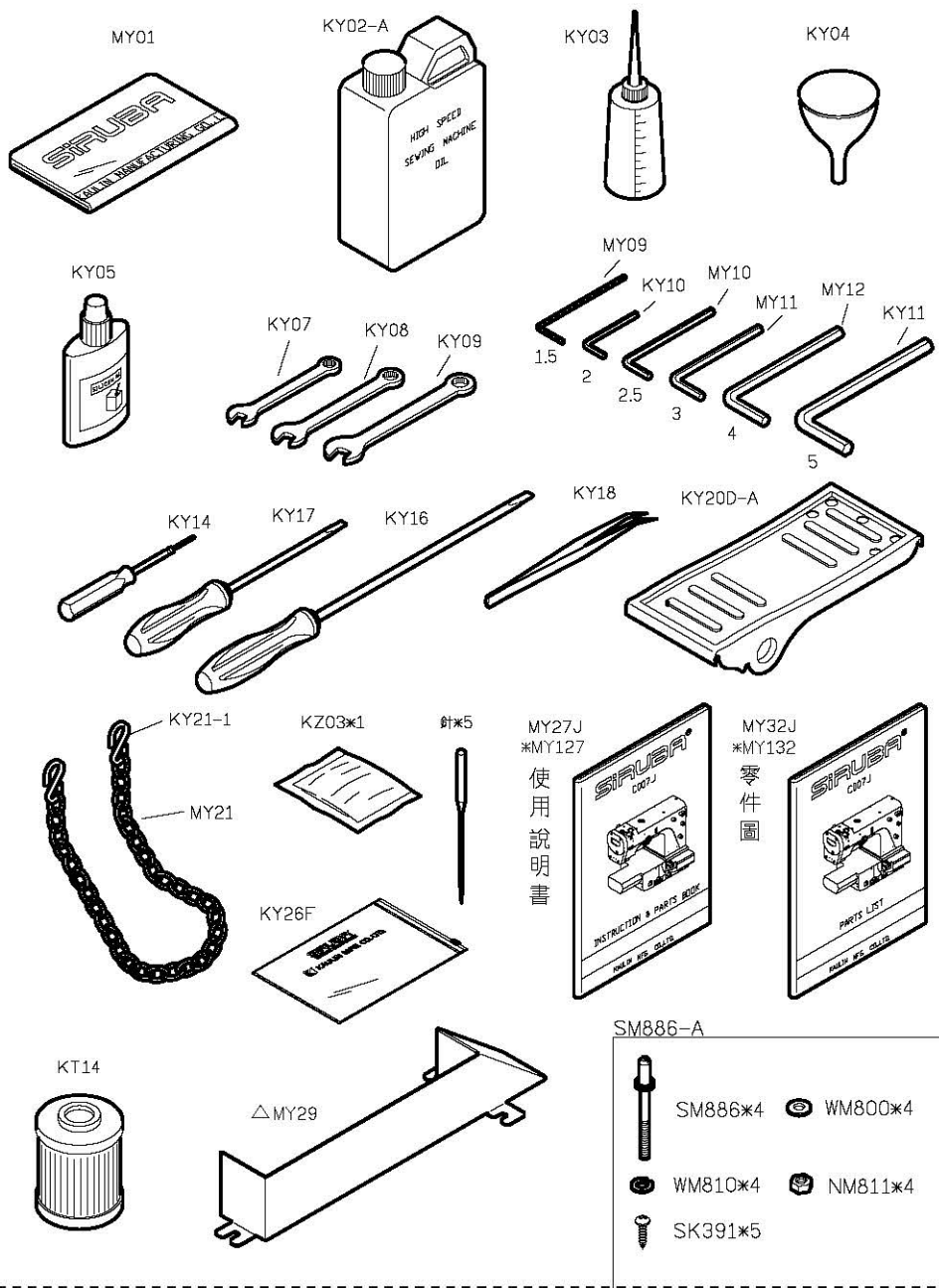



# C007JD

高林股份有限公司 KAULIN MFG. CO., LTD.