

# SIRUBA®

銀箭牌工業用縫紉機

INDUSTRIAL SEWING MACHINE





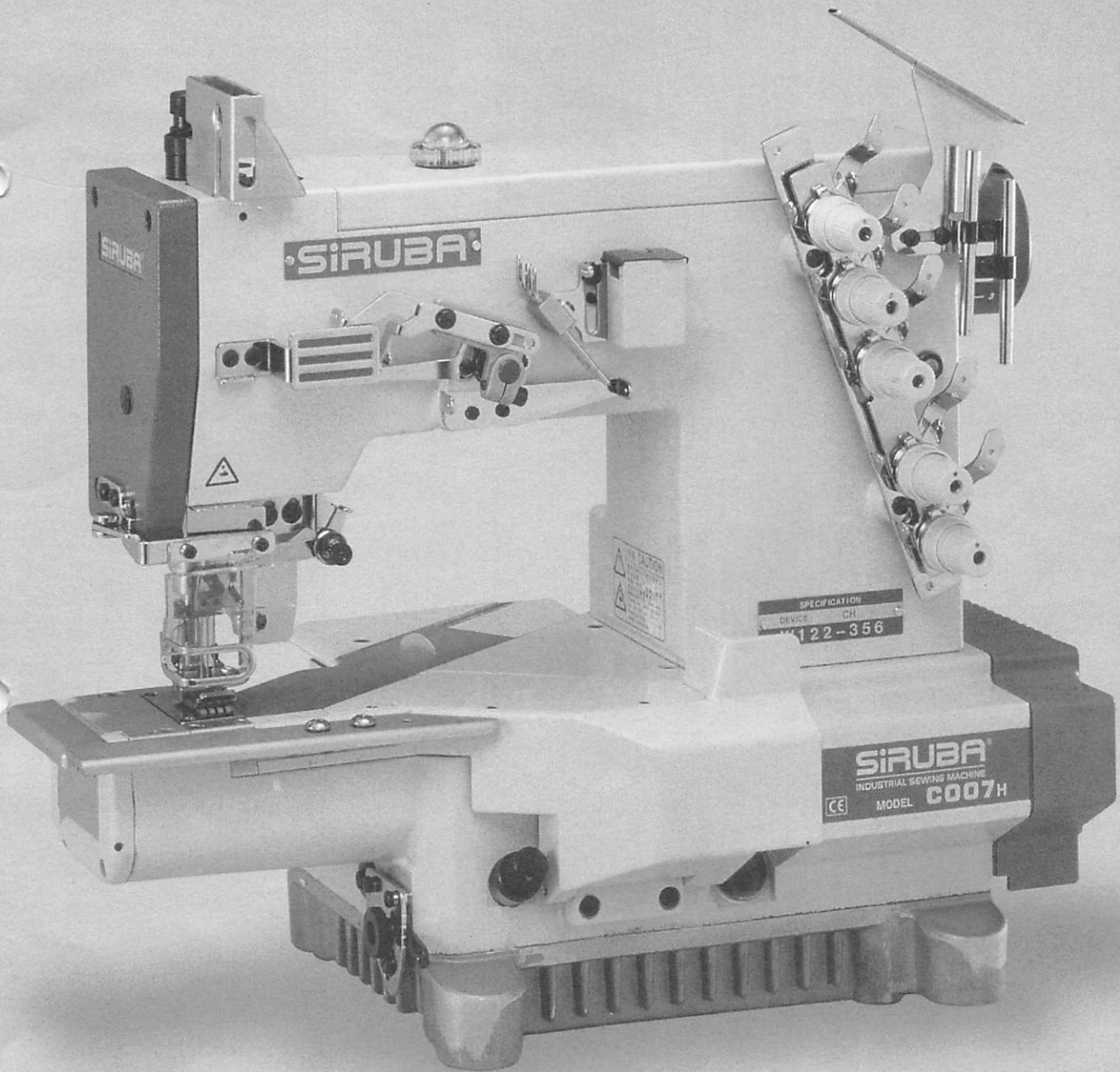

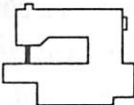

# C007H

## 零件圖 PARTS LIST



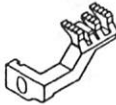
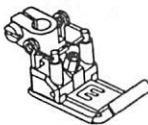







CE

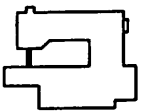
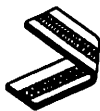



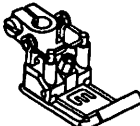

 高林股份有限公司  
KAULIN MFG. CO., LTD.

									
MODEL	SUB - CLASS	NEEDLE CLAMP	NEEDLE PLATE	MAIN FEED DOG	DIFF. FEED DOG	PRESSER FOOT	SPREADER	LOOPER	NEEDLE
機 型	規 格	針 座	針 板	主 送 具	差 送 具	押 具	上 叉	勾 針	針 號
C007H - W122 / CH	240	M5240	E3524P	D4206	H4258	P0024	MH41E	MT01	UY128GAS #11
	248	M5248	E3525P	D4206	H4258	P0025			
	256	M5356	E3826S	D4206	H4258	P0216			
	356	M5356	E3826P	D4206	H4258	P0216			
	364	M5364	E3827P	D4207	H4259	P0217			
C007H - U122 / CH	240	M5240	E3524P	D4206	H4258	P0314	-	MT01	UY128GAS #11
	248	M5248	E3525P	D4206	H4258	P0315			
	256	M5356	E3826S	D4206	H4258	P0416			
	356	M5356	E3826P	D4206	H4258	P0416			
	364	M5364	E3827P	D4207	H4259	P0417			
C007H - W122 CH / UTP (UTR )	240	M5240	E3524P	D4206	H4258	P0024	MH41E	MT01	UY128GAS #11
	248	M5248	E3525P	D4206	H4258	P0025			
	256	M5356	E3826S	D4206	H4258	P0216			
	356	M5356	E3826P	D4206	H4258	P0216			
	364	M5364	E3827P	D4207	H4259	P0217			
C007H - U122 CH / UTQ (UTS )	240	M5240	E3524P	D4206	H4258	P0314	-	MT01	UY128GAS #11
	248	M5248	E3525P	D4206	H4258	P0315			
	256	M5356	E3826S	D4206	H4258	P0416			
	356	M5356	E3826P	D4206	H4258	P0416			
	364	M5364	E3827P	D4207	H4259	P0417			
C007H - W122/CHA	356	M5356	E3826Q	D4206	H4258	P0216	MH41E	MT01	UY128GAS #11





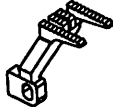
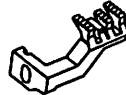
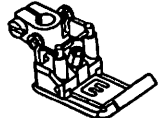
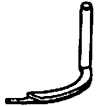





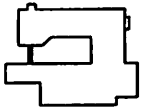

## 規格件表 • CONVERSION CHART

									
MODEL	SUB - CLASS	NEEDLE CLAMP	NEEDLE PLATE	MAIN FEED DOG	DIFF. FEED DOG	PRESSER FOOT	SPREADER	LOOPER	NEEDLE
機 型	規 格	針 座	針 板	主 送 具	差 送 具	押 具	上 叉	勾 針	針 號
C007H - U122/CHA	356	M5356	E3826Q	D4206	H4258	P0416	-	MT01	UY128GAS #11
C007H - W132 / CHE	240	M5240	E2324P	D2109	H2219	P2904	MH41E	MT01	UY128GAS #11
	248	M5248	E2325P	D2109	H2219	P2905			
	356	M5356	E2326P	D2110	H2220	P2906			
	364	M5364	E2327P	D2110	H2220	P2907			
C007H - W132 /CHE/UTP(UTR)	356	M5356	E2326P	D2110	H2220	P2906	MH41E	MT01	UY128GAS #11
	364	M5364	E2327P	D2110	H2220	P2907			
C007H - W152 /CZ/UTP/RLQ	356	M5356	E4326P	D3216	H3262	P2416	MH41E	MT01	UY128GAS #11
	364	M5364	E4327P	D3217	H3263	P2417			
C007H - U152 /CZ/UTQ/RLQ	356	M5356	E4326P	D3216	H3262	P2416	-	MT01	UY128GAS #11
	364	M5364	E4327P	D3217	H3263	P2417			
C007H - W152 /CZ/CLA/UTP/RLQ	356	M5356	E4326P	D3216	H3262	P2416	MH41E	MT01	UY128GAS #11
	364	M5364	E4327P	D3217	H3263	P2417			
C007H - U152 /CZ/CLA/UTQ/RLQ	356	M5356	E4326P	D3216	H3262	P2416	-	MT01	UY128GAS #11
	364	M5364	E4327P	D3217	H3263	P2417			
C007H - W152 /CZP/RLQ	356	M5356	E4326	D3216	H3262	P2416	MH41E	MT01	UY128GAS #11
	364	M5364	E4327	D3217	H3263	P2417			
C007H - U152 /CZP/RLQ	356	M5356	E4326	D3216	H3262	P2416	-	MT01	UY128GAS #11
	364	M5364	E4327	D3217	H3263	P2417			
C007H - W152 /CZP/CLA/RLQ	356	M5356	E4326	D3216	H3262	P2416	MH41E	MT01	UY128GAS #11
	364	M5364	E4327	D3217	H3263	P2417			
C007H - U152 /CZP/CLA/RLQ	356	M5356	E4326	D3216	H3262	P2416	-	MT01	UY128GAS #11
	364	M5364	E4327	D3217	H3263	P2417			



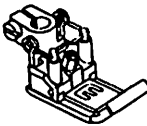





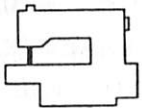

									
MODEL	SUB - CLASS	NEEDLE CLAMP	NEEDLE PLATE	MAIN FEED DOG	DIFF. FEED DOG	PRESSER FOOT	SPREADER	LOOPER	NEEDLE
機 型	規 格	針 座	針 板	主 送 具	差 送 具	押 具	上 叉	勾 針	針 號
C007H - W162	240	M5240	E3544	D4206	H4258	P0234	MH41E	MT01A	UY128GAS #14 - 16
	248	M5248	E3545	D4206	H4258	P0235			
	356	M5356	E3846	D4206	H4258	P0226			
	364	M5364	E3847	D4207	H4259	P0227			
C007H - U162	240	M5240	E3544	D4206	H4258	P0234	-	MT01	UY128GAS #11
	248	M5248	E3545	D4206	H4258	P0235			
	356	M5356	E3846	D4206	H4258	P0226			
	364	M5356	E3847	D4207	H4259	P0227			
C007H - W162 / UTP (UTR)	240	M5240	E3544	D4206	H4258	P0234	MH41E	MT01A	UY128GAS #14 - 16
	248	M5248	E3545	D4206	H4258	P0235			
	356	M5356	E3846	D4206	H4258	P0226			
	364	M5364	E3847	D4207	H4259	P0227			
C007H - U162 / UTQ (UTS)	240	M5240	E3544	D4206	H4258	P0234	-	MT01A	UY128GAS #14 - 16
	248	M5248	E3545	D4206	H4258	P0235			
	356	M5356	E3846	D4206	H4258	P0226			
	364	M5356	E3847	D4207	H4259	P0227			
C007H - W222 / CQ	240	M5240	E4124P	D3216	H3362	P1814	MH41E	MT01	UY128GAS #11
	248	M5248	E4125P	D3216	H3362	P1815			
	356	M5356	E4426P	D3216	H3362	P2116			
	364	M5364	E4427P	D3217	H3363	P2117			
C007H - U222 / CQ	240	M5240	E4124P	E3216	H3362	P2314	-	MT01	UY128GAS #11
	248	M5248	E4125P	D3216	H3362	P2315			
	356	M5356	E4426P	D3216	H3362	P2616			

規 格 件 表 • CONVERSION CHART









## 規格件表 • CONVERSION CHART

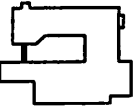



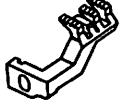
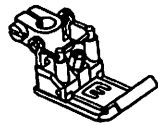



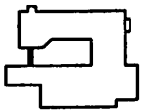

									
MODEL	SUB - CLASS	NEEDLE CLAMP	NEEDLE PLATE	MAIN FEED DOG	DIFF. FEED DOG	PRESSER FOOT	SPREADER	LOOPER	NEEDLE
機 型	規 格	針 座	針 板	主 送 具	差 送 具	押 具	上 叉	勾 針	針 號
C007H-U222 / CQ	364	M5356	E4427P	D3217	H3363	P2617	-	MT01	UY128GAS #11
C007H - W222 /CQA/CLA	256	M5356	E2326Q	D2110	H2220Q	P2906Q	MH41E	MT01	UY128GAS #11
C007H - W322 / CC	356	M5356	E2826P	D2107L	H3259M	P1406	MH41E	MT01	UY128GAS #11
	364	M5364	E2827P	D2107L	H3259M	P1407			
C007H - U322 / CC	356	M5356	E2826P	D2107L	H3259M	P1406	-	MT01	UY128GAS #11
	364	M5364	E2827P	D2107L	H3259M	P1407			
C007H - W322 CC / UTP (UTR)	356	M5356	E2826P	D2107L	H3259M	P1406	MH41E	MT01	UY128GAS #11
	364	M5364	E2827P	D2107L	H3259M	P1407			
C007H - U322 CC / UTQ (UTS)	356	M5356	E2826P	D2107L	H3259M	P1406	-	MT01	UY128GAS #11
	364	M5364	E2827P	D2107L	H3259M	P1407			
C007H - W322 / CD	356	M5356	E3626P	D4206	H4158	P1406	MH41E	MT01	UY128GAS #11
	364	M5364	E3627P	D4207	H4159	P1407			
C007H - U322 / CD	356	M5356	E3626P	D4206	H4158	P1606	-	MT01	UY128GAS #11
	364	M5364	E3627P	D4207	H4159	P1607			
C007H - W322 CD / UTP (UTR)	356	M5356	E3626P	D4206	H4158	P1406	MH41E	MT01	UY128GAS #11
	364	M5364	E3627P	D4207	H4159	P1407			
C007H - U322 CD / UTQ (UTS)	356	M5356	E3626P	D4206	H4158	P1606	-	MT01	UY128GAS #11
	364	M5364	E3627P	D4207	H4159	P1607			
C007H - W322 / CE	356	M5356	E2626P	D2107	H3159	P1406	MH41E	MT01	UY128GAS #11
	364	M5364	E2627P	D2107	H3159	P1407			
C007H - U322 / CE	356	M5356	E2626P	D2107	H3159	P1406	-	MT01	UY128GAS #11
	364	M5364	E2627P	D2107	H3159	P1407			

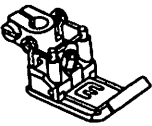

									
MODEL	SUB - CLASS	NEEDLE CLAMP	NEEDLE PLATE	MAIN FEED DOG	DIFF. FEED DOG	PRESSER FOOT	SPREADER	LOOPER	NEEDLE
機 型	規 格	針 座	針 板	主 送 具	差 送 具	押 具	上 叉	勾 針	針 號
C007H - W322 CE / UTP (UTR)	356	M5356	E2626P	D2107	H3159	P1406	MH41E	MT01	UY128GAS #11
	364	M5364	E2627P	D2107	H3159	P1407			
C007H - U322 CE / UTQ (UTS)	356	M5356	E2626P	D2107	H3159	P1606	-	MT01	UY128GAS #11
	364	M5364	E2627P	D2107	H3159	P1607			
C007H - U322/CF	248	M5348	E2625P	D2106	H3158	P1605	-	MT01	UY128GAS #11
C007H - U322 CF / UTQ(UTS)	248	M5348	E2625P	D2106	H3158	P1605	-	MT01	UY128GAS #11
C007H - W512 / FE (FFC )	240	M5240	E3524P	D4206	H4258	P2914	MH41E	MT01	UY128GAS #11
	356	M5356	E3826P	D4206	H4258	P3216			
	364	M5364	E3827P	D4207	H4259	P3217			
C007H - U512 / FE (FFC)	240	M5240	E3524P	D4206	H4258	P3414	-	MT01	UY128GAS #11
	356	M5356	E3826P	D4206	H4258	P3716			
	364	M5364	E3827P	D4207	H4259	P3717			
C007H - W522 FE(FFC)/CRA/CL	356	M5356	E6426	D3222	H3268	P3116P	MH41E	MT01	UY128GAS #11
	364	M5364	E6427	D3222	H3268	P3117P			
C007H - U522 FE(FFC)/CRA/CL	356	M5356	E6426	D3222	H3268	P3116P	-	MT01	UY128GAS #11
	364	M5364	E6427	D3222	H3268	P3117P			
C007H - W522 FE(FFC)/CRB/CL	356	M5356	E6426	D3222	H3268	P3116P	MH41E	MT01	UY128GAS #11
	364	M5364	E6427	D3222	H3268	P3117P			
C007H - U522 FE(FFC)/CRB/CL	356	M5356	E6426	D3222	H3268	P3116P	-	MT01	UY128GAS #11
	364	M5364	E6427	D3222	H3268	P3117P			
C007H - W532CRA /UTP/CL/RLP/CX	356	M5356	E6426	D3222	H3268	P3816Q	MH41E	MT01	UY128GAS #11
	364	M5364	E6427	D3222	H3268	P3817Q			

# 規格件表 • CONVERSION CHART

									
MODEL	SUB - CLASS	NEEDLE CLAMP	NEEDLE PLATE	MAIN FEED DOG	DIFF. FEED DOG	PRESSER FOOT	SPREADER	LOOPER	NEEDLE
機 型	規 格	針 座	針 板	主 送 具	差 送 具	押 具	上 叉	勾 針	針 號
C007H - U532CRA UTQ/CL/RLP/CX	356	M5356	E6426	D3222	H3268	P3816Q	-	MT01	UY128GAS #11
	364	M5364	E6427	D3222	H3268	P3817Q			
C007H - W532CRB UTP/CL/RLP/CX	356	M5356	E6426	D3222	H3268	P3816Q	MH41E	MT01	UY128GAS #11
	364	M5364	E6427	D3222	H3268	P3817Q			
C007H - U532CRB UTQ/CL/RLP/CX	356	M5356	E6426	D3222	H3268	P3816Q	-	MT01	UY128GAS #11
	364	M5364	E6427	D3222	H3268	P3817Q			
C007H - W542 CFC(CFE)/CL	240	M5240	E2324P	D2109	H2219	P2904	MH41E	MT01	UY128GAS #11
	248	M5248	E2325P	D2109	H2219	P2905			
	356	M5356	E2326P	D2110	H2220	P2906			
	364	M5364	E2327P	D2110	H2220	P2907			
C007H - U542 CFC(CFE) /CL	240	M5240	E2324P	D2109	H2219	P2904	-	MT01	UY128GAS #11
	248	M5248	E2325P	D2109	H2219	P2905			
	356	M5356	E2326P	D2110	H2220	P2906			
	364	M5364	E2327P	D2110	H2220	P2907			
C007H - W812 CRL / RL	356	M5356	E0226Q	D2101Q	H2203Q	P2766	MH41E	MT01	UY128GAS #11
	364	M5364	E0227Q	D2101Q	H2203Q	P2767			
C007H - U812 CRL / RL	356	M5356	E0226Q	D2101Q	H2203Q	P0966	-	MT01	UY128GAS #11
	364	M5364	E0227Q	D2101Q	H2203Q	P0967			
C007H - W812 CRL/CHP/RL	356	M5356	E0226Q	D2101Q	H2203Q	P2766	MH41E	MT01	UY128GAS #11
	364	M5364	E0227Q	D2101Q	H2203Q	P2767			
C007H - U812 CRL/CHP/RL	356	M5356	E0226Q	D2101Q	H2203Q	P0966	-	MT01	UY128GAS #11
	364	M5364	E0227Q	D2101Q	H2203Q	P0967			

									
MODEL	SUB - CLASS	NEEDLE CLAMP	NEEDLE PLATE	MAIN FEED DOG	DIFF. FEED DOG	PRESSER FOOT	SPREADER	LOOPER	NEEDLE
機 型	規 格	針 座	針 板	主 送 具	差 送 具	押 具	上 叉	勾 針	針 號
C007H - W812 CRL/CHP/UTP/RL	356	M5356	E0226Q	D2101Q	H2203Q	P2766	MH41E	MT01	UY128GAS #11
	364	M5364	E0227Q	D2101Q	H2203Q	P2767			
C007H - U812 CRL/CHP/UTQ/RL	356	M5356	E0226Q	D2101Q	H2203Q	P0966	-	MT01	UY128GAS #11
	364	M5364	E0227Q	D2101Q	H2203Q	P0967			
C007H - W822 CRL/CY/CL/RL	356	M5356	E0226Q	D2101Q	H2203Q	P2766	MH41E	MT01	UY128GAS #11
	364	M5364	E0227Q	D2101Q	H2203Q	P2767			
C007H - U822 CRL/CY/CL/RL	356	M5356	E0226Q	D2101Q	H2203Q	P0966	-	MT01	UY128GAS #11
	364	M5364	E0227Q	D2101Q	H2203Q	P0967			
C007H - W822 CRL/CY/UTP/CL/RL	356	M5356	E0226Q	D2101Q	H2203Q	P2766	MH41E	MT01	UY128GAS #11
	364	M5364	E0227Q	D2101Q	H2203Q	P2767			
C007H - U822 CRL/CY/UTQ/CL/RL	356	M5356	E0226Q	D2101Q	H2203Q	P0966	-	MT01	UY128GAS #11
	364	M5364	E0227Q	D2101Q	H2203Q	P0967			
C007H - U822 CRL/CY/UTQ/CL/RL	356	M5356	E0226Q	D2101Q	H2203Q	P0966	-	MT01	UY128GAS #11
	364	M5364	E0227Q	D2101Q	H2203Q	P0967			



# PARTS LIST FOR MF GROUP

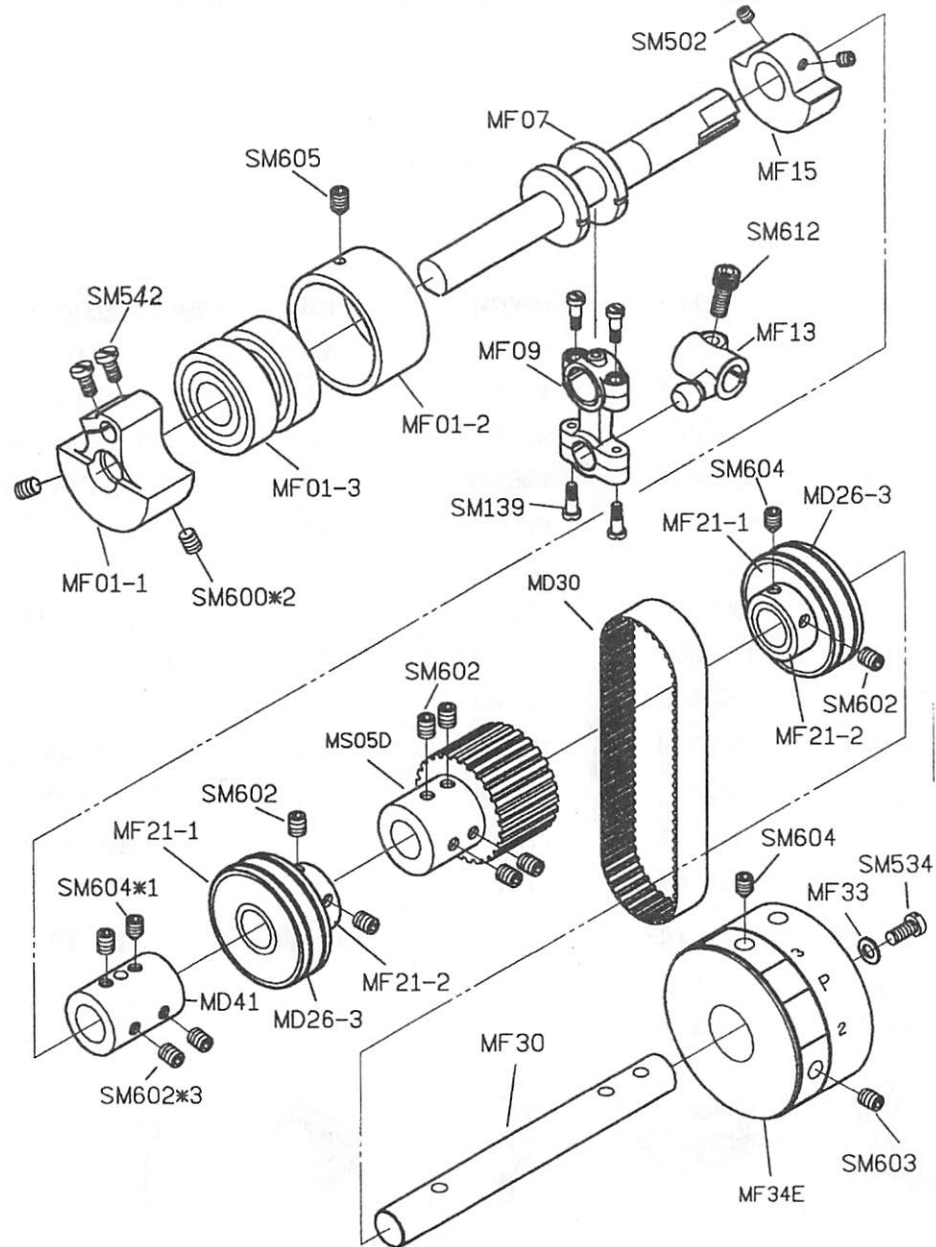

# PARTS LIST FOR MG GROUP

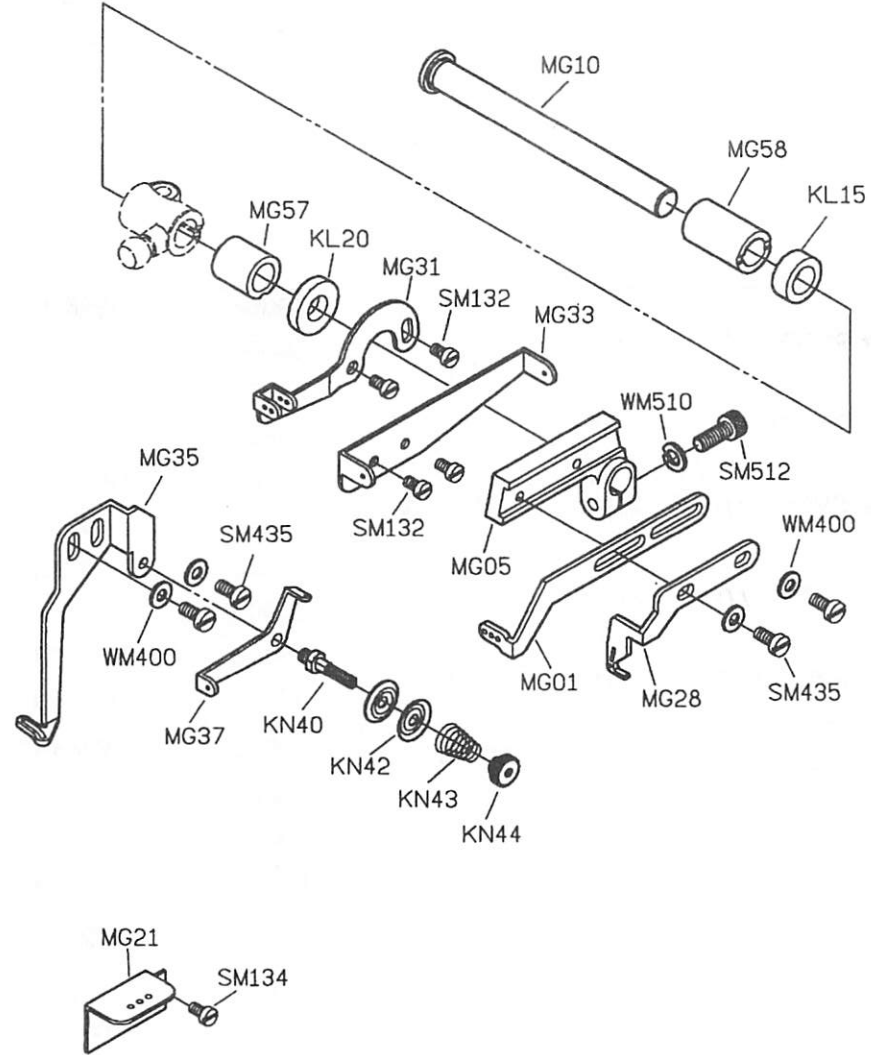

PARTS LIST FOR MJ GROUP

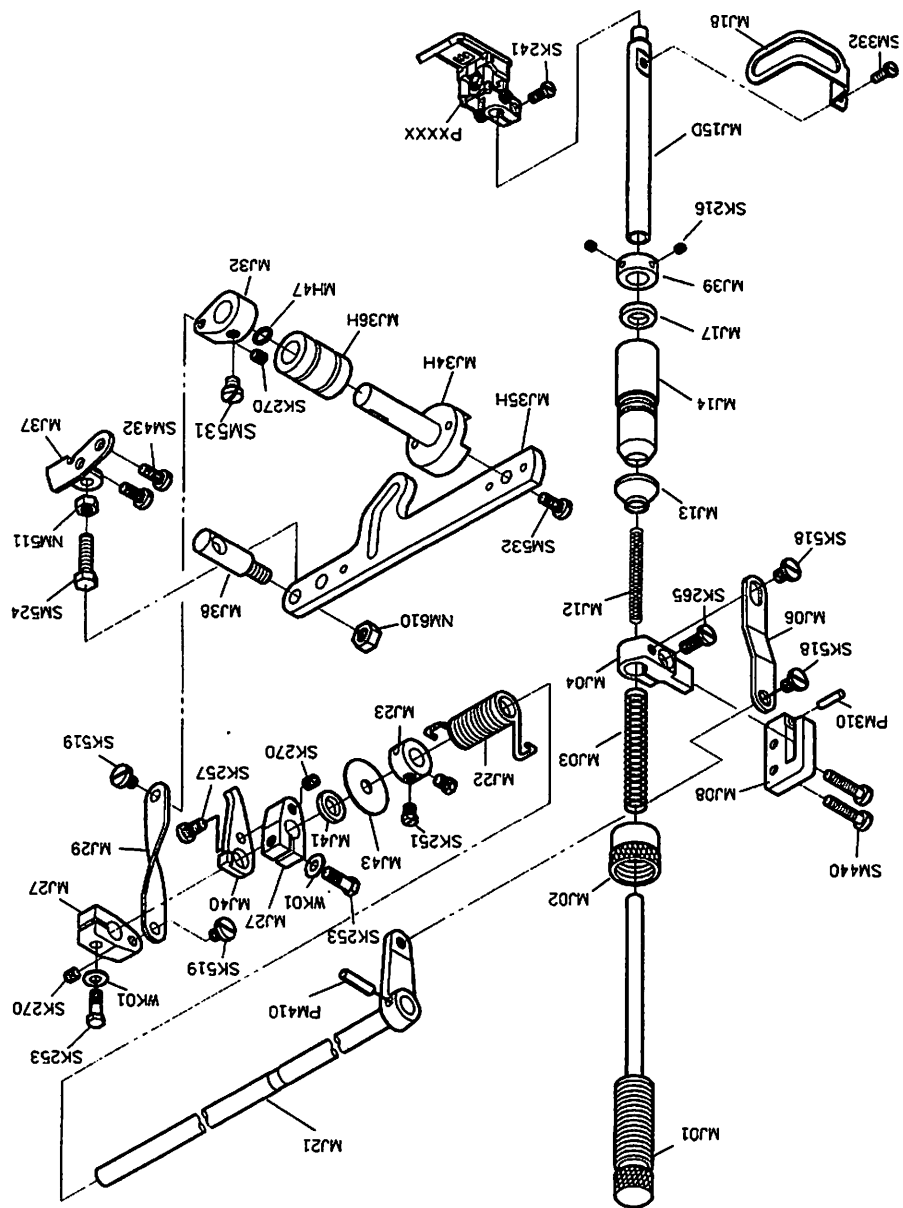

PARTS LIST FOR MH GROUP

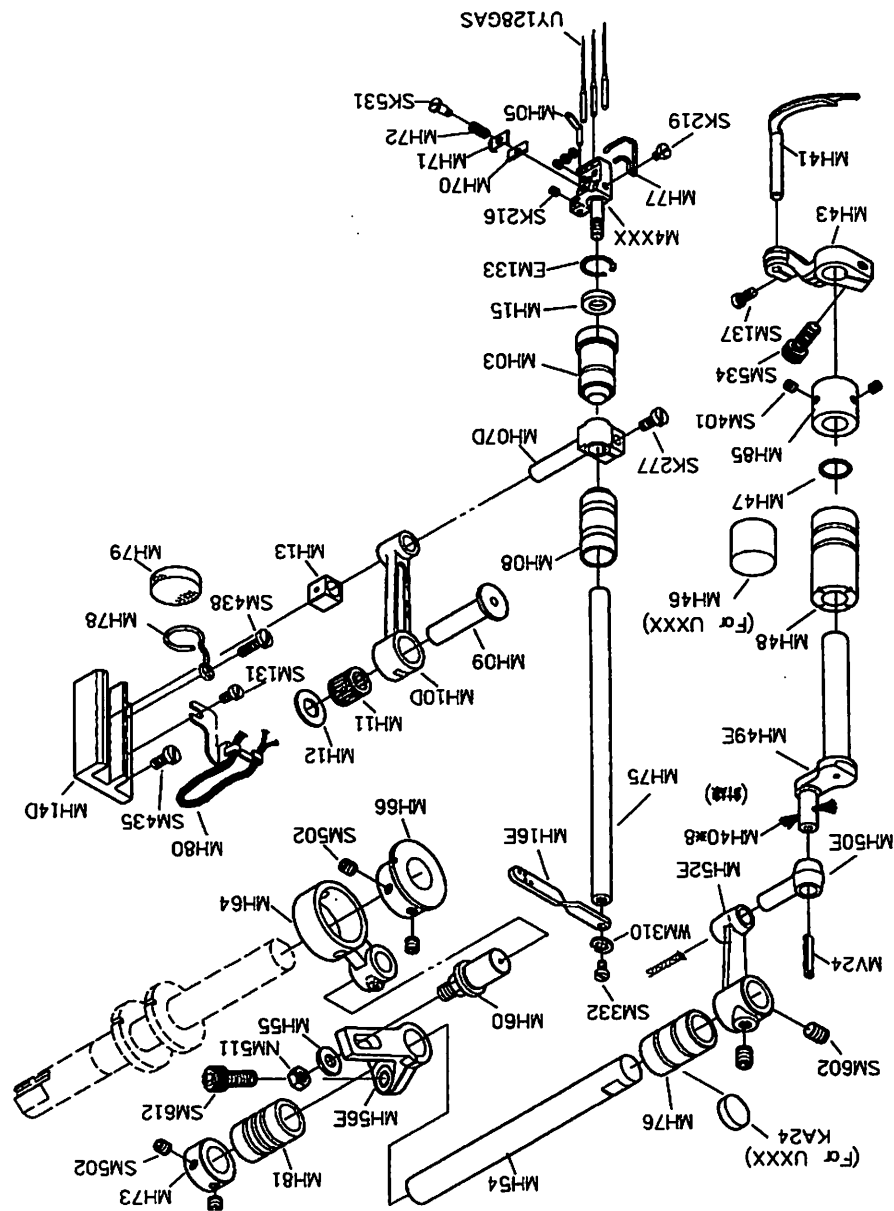

# PARTS LIST FOR MK GROUP

# PARTS LIST FOR MN(1) GROUP

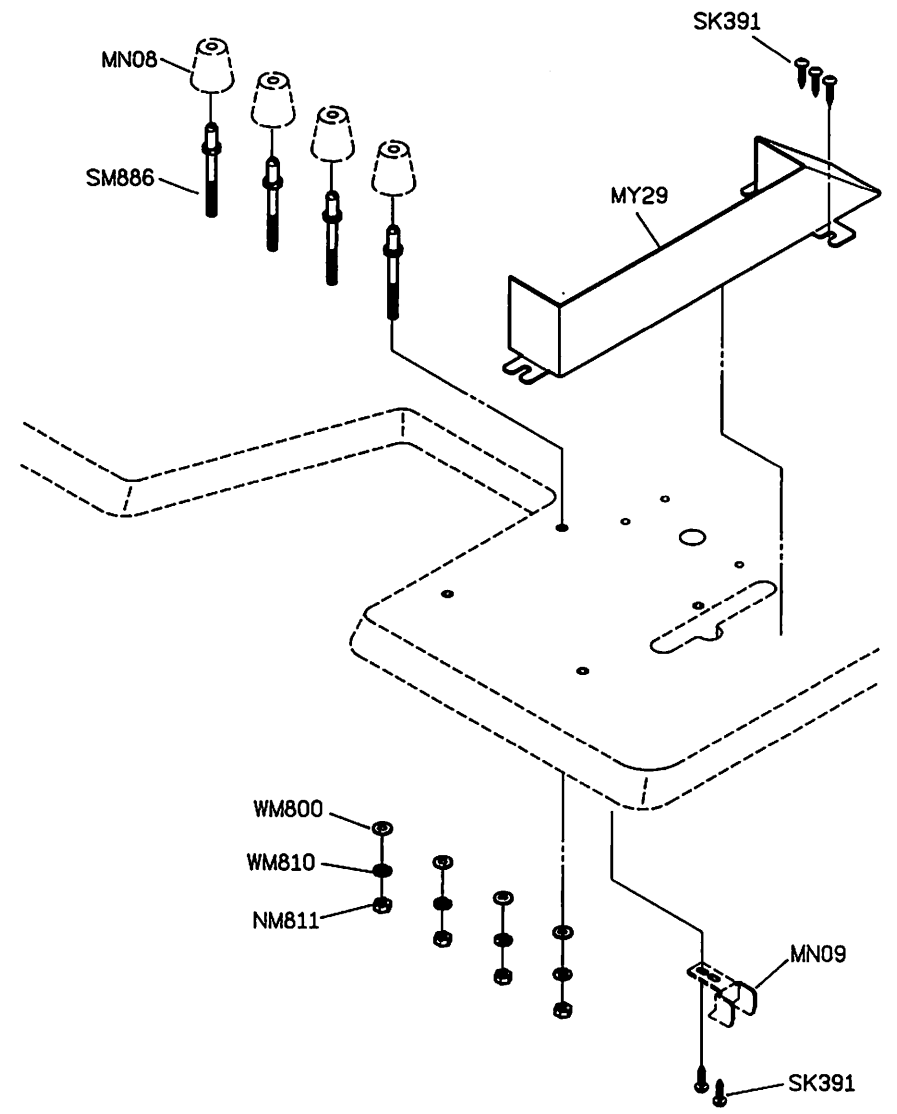
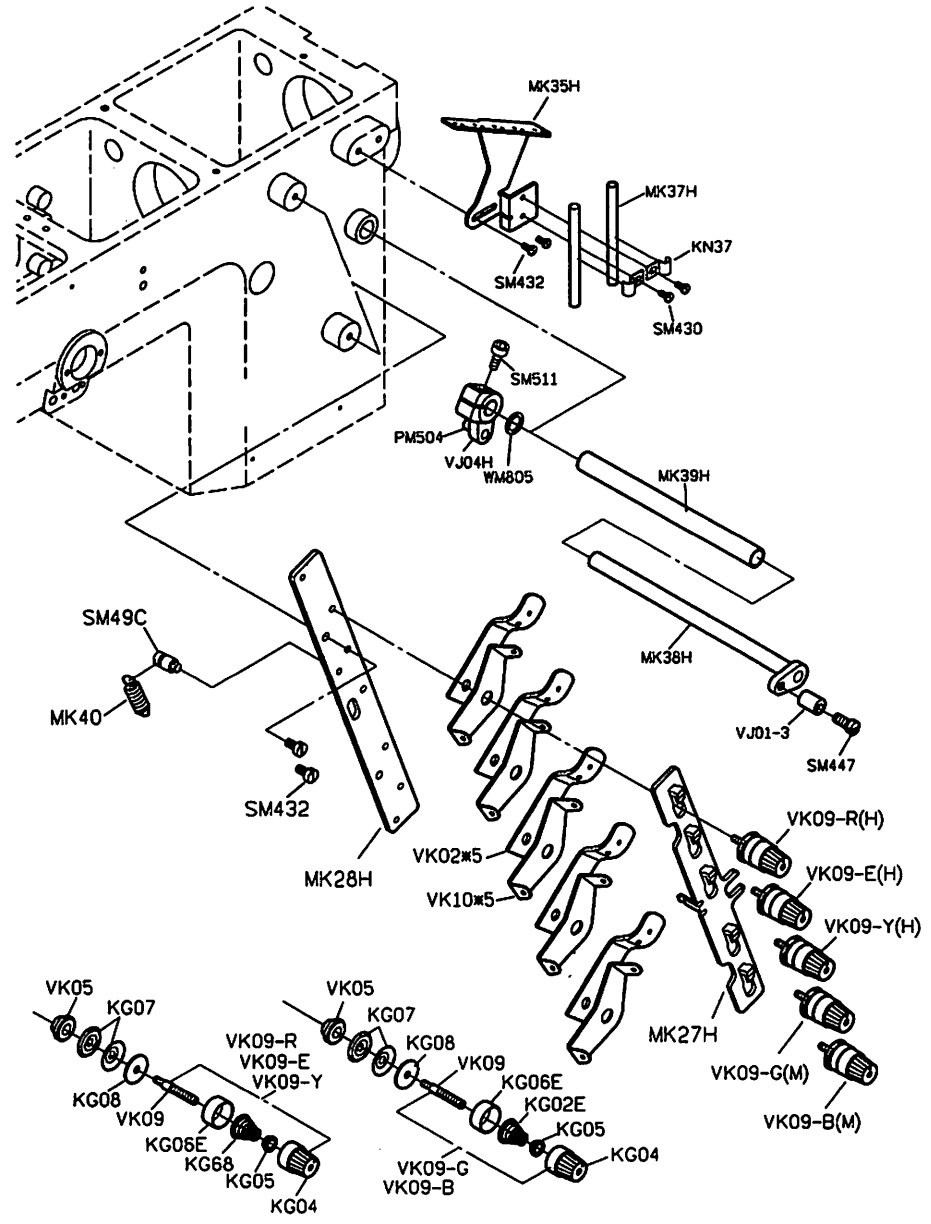









PARTS LIST FOR MU GROUP

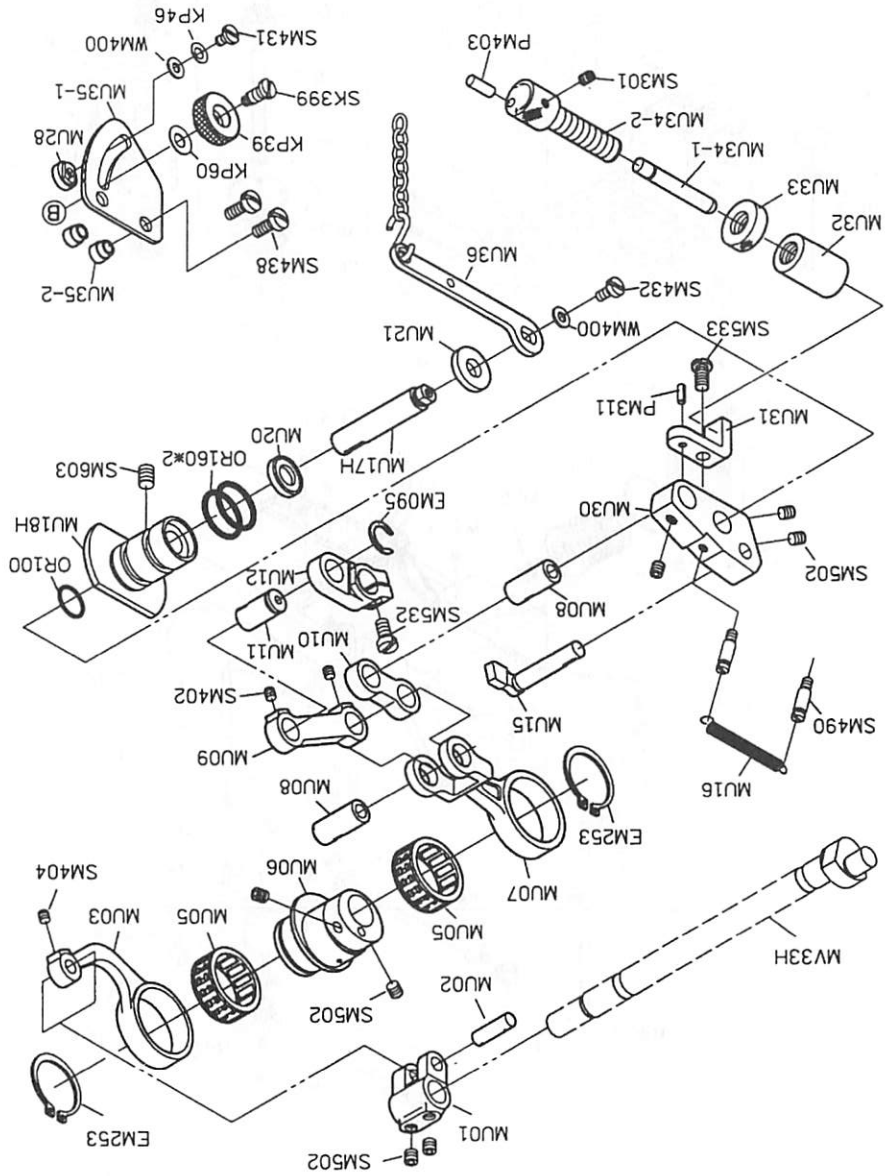

PARTS LIST FOR MT GROUP

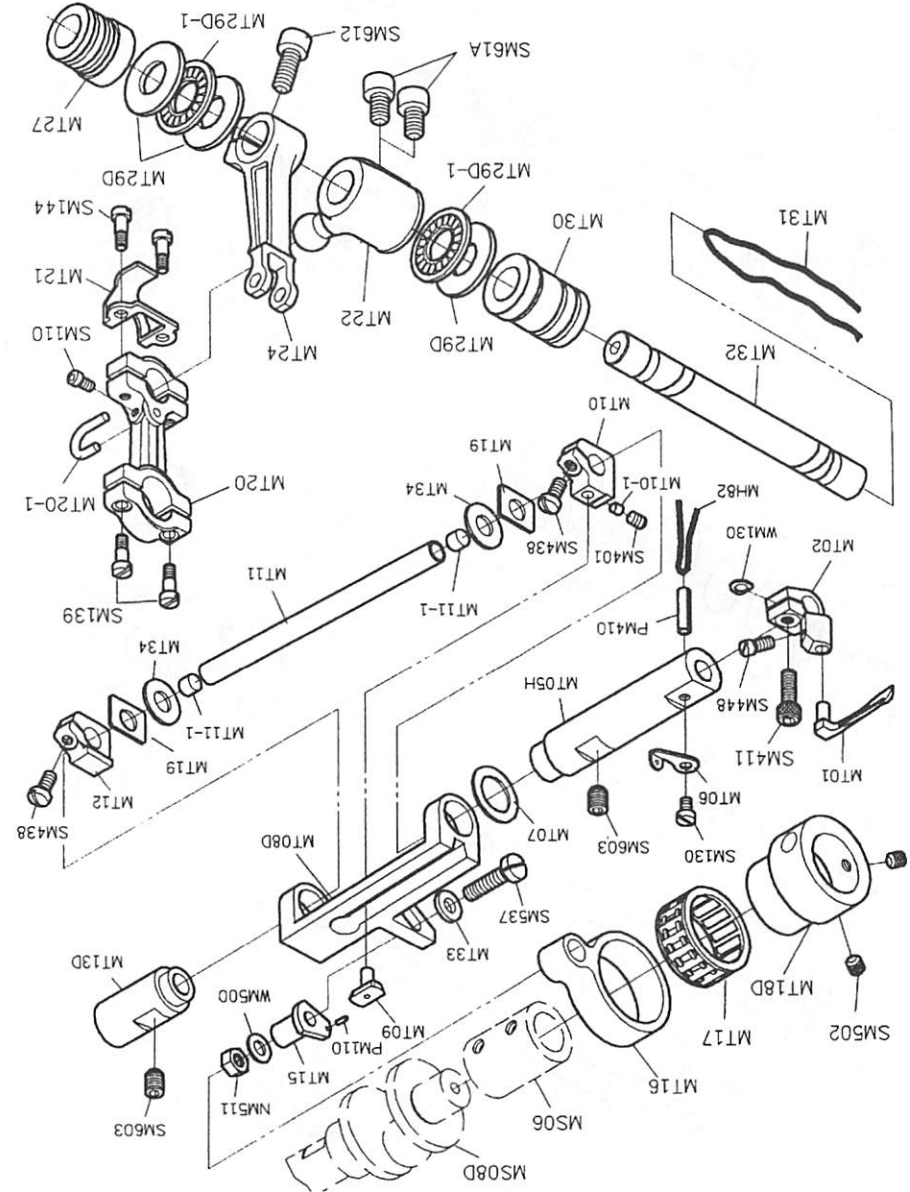



# PARTS LIST FOR MV GROUP

# PARTS LIST FOR MW GROUP

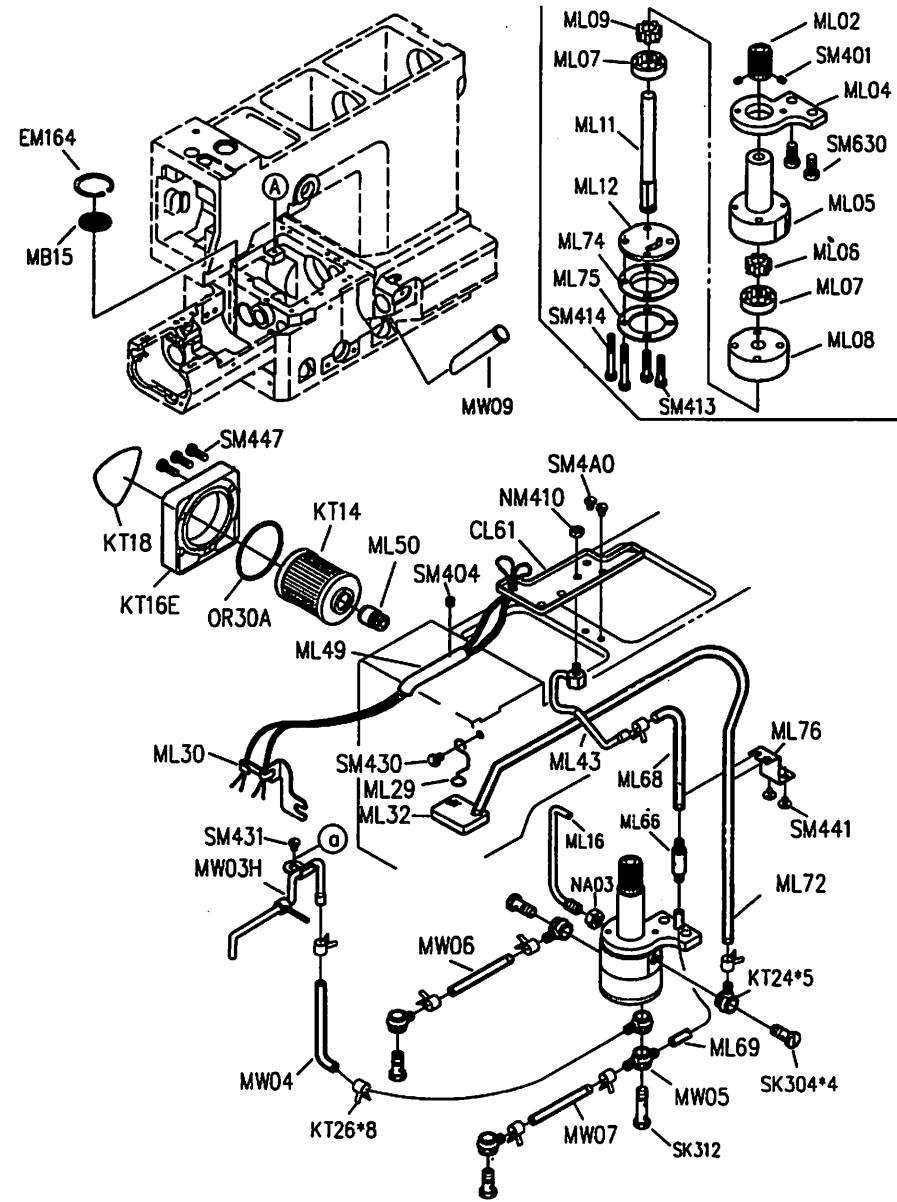
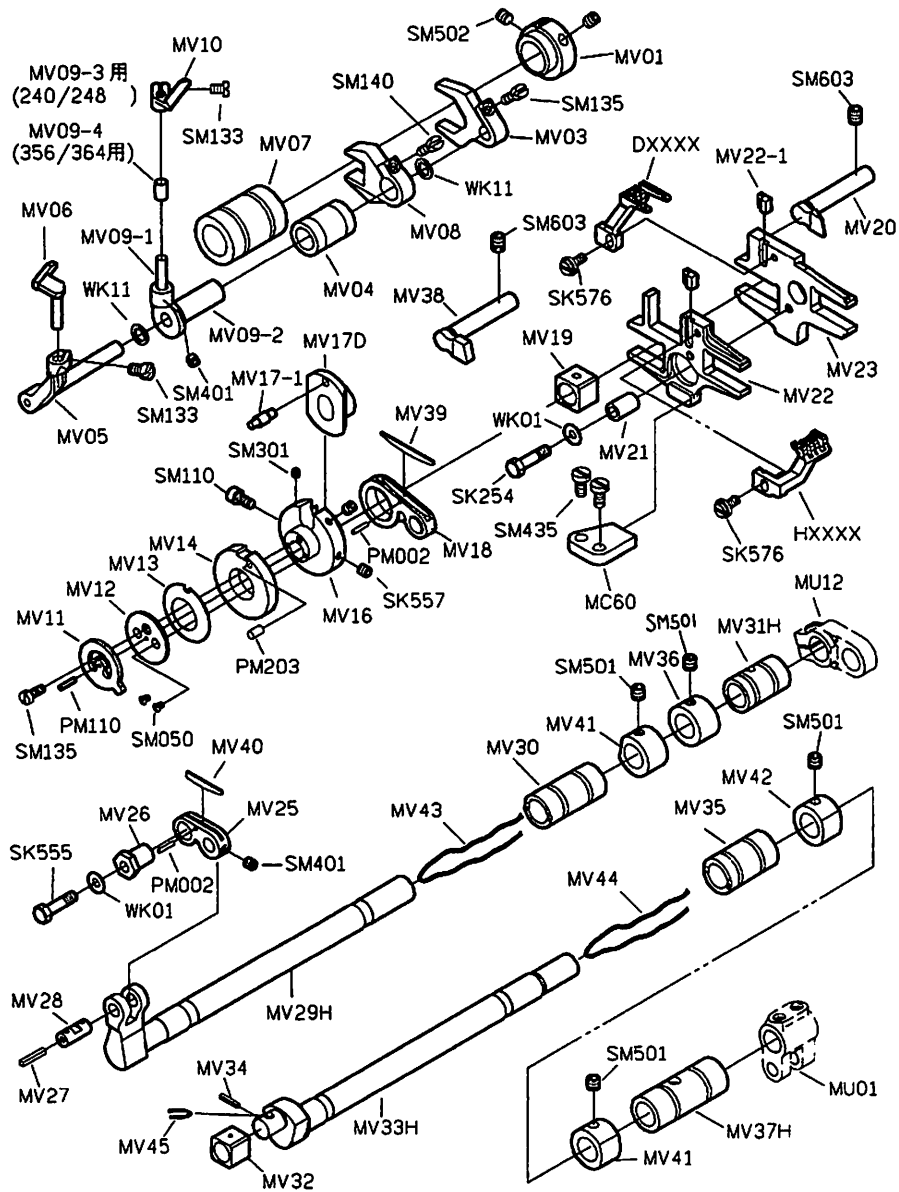

PARTS LIST FOR MZ GROUP

MZ23	SIRUBA	K
	GOLDEX	G
	TAIKO	T

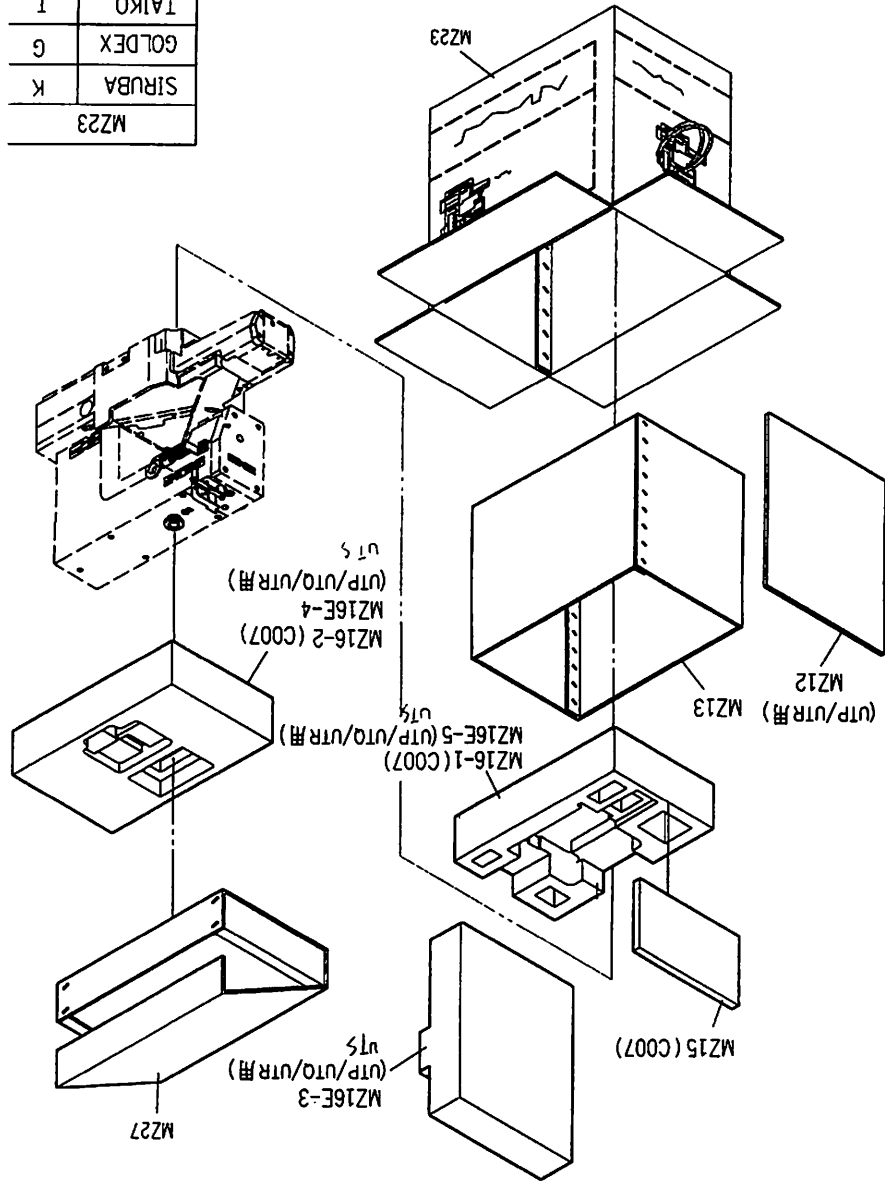

PARTS LIST FOR MY GROUP

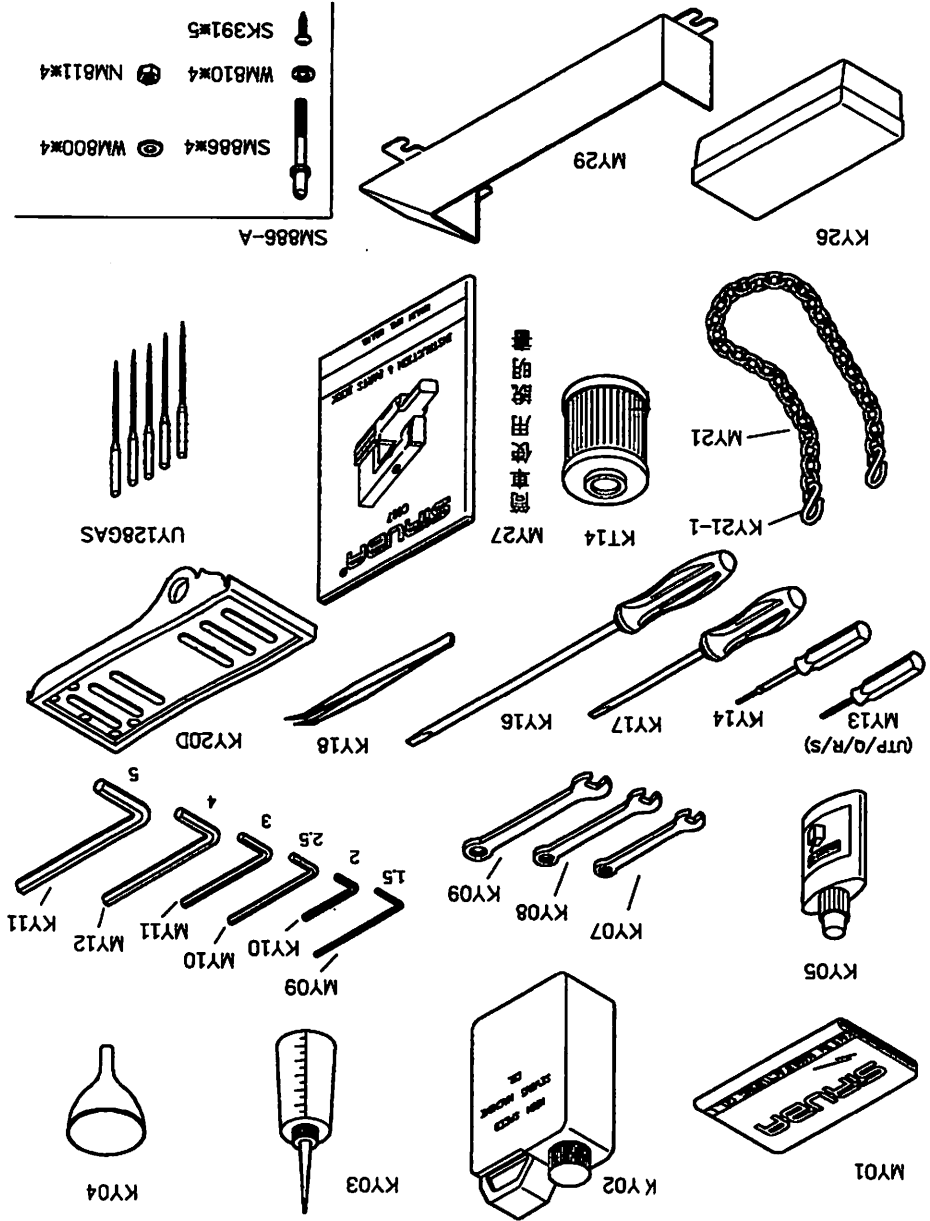

# PARTS LIST FOR KW GROUP

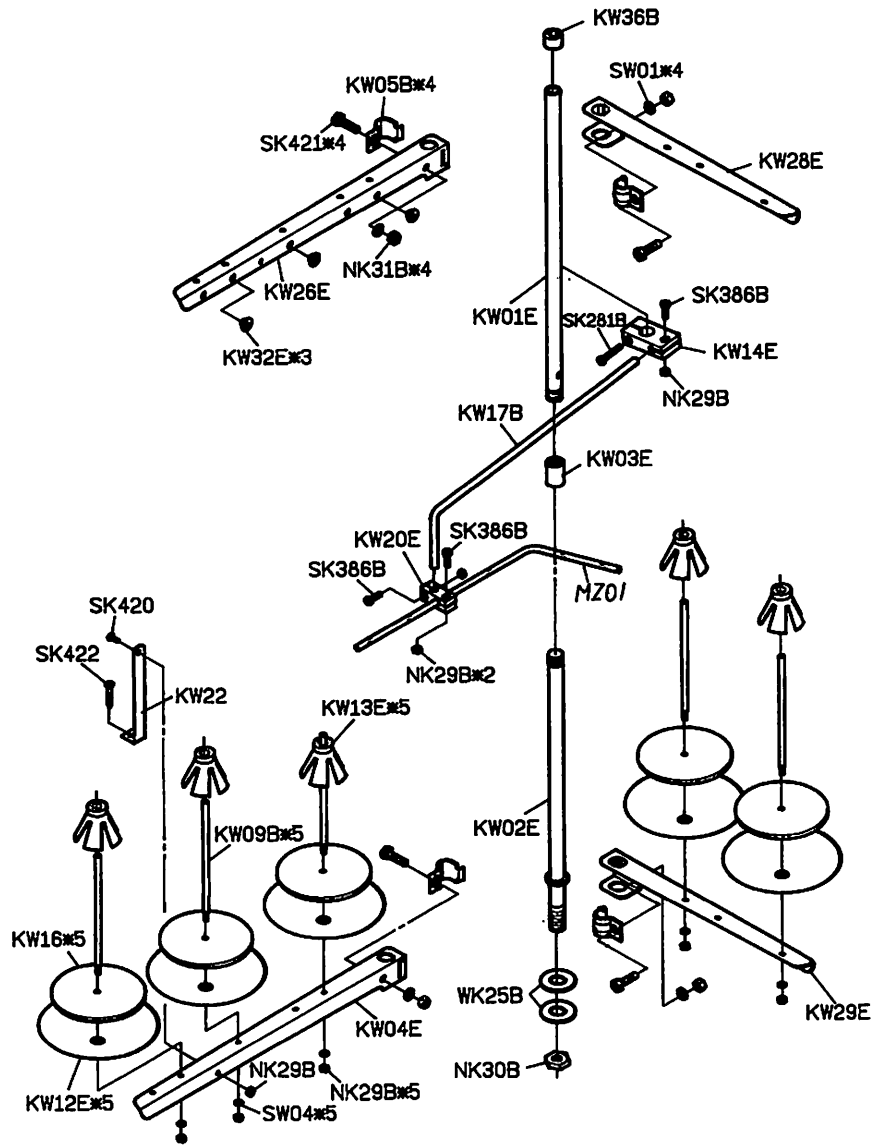





# C007<sub>H</sub>

高林股份有限公司 KAULIN MFG. CO.,LTD.

The specification and/or appearances of the equipment described in this parts list are subject to change because of modification without previous notice.

MY32H. MAR. 2002

From the library of Superior Sewing Machine & Supply LLC - [www.supsew.com](http://www.supsew.com)