

SIRUBA®

C007E

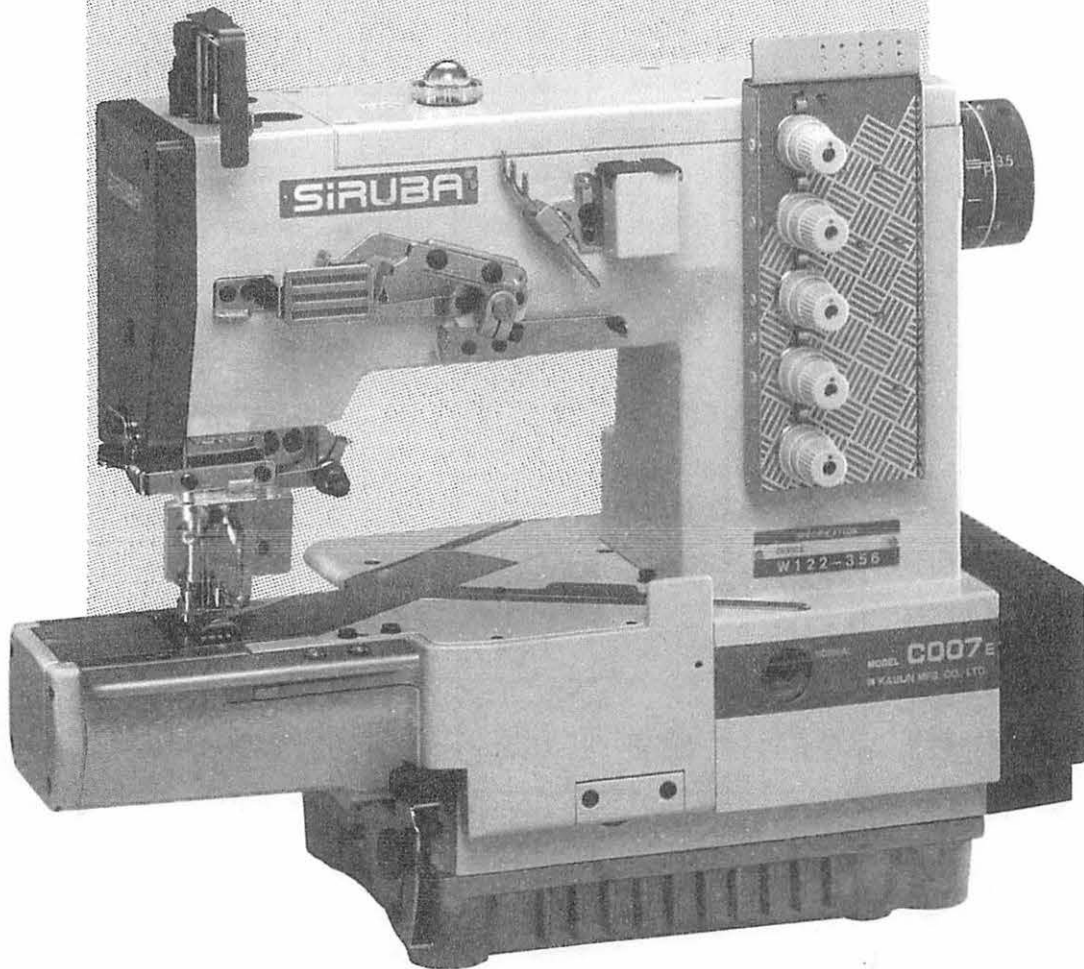







零件圖 PARTS LIST





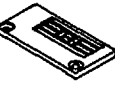

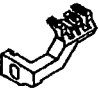
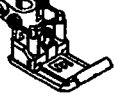



高林股份有限公司
KAULIN MFG. CO., LTD.

From the library of: Superior Sewing Machine & Supply LLC

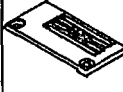
簡單規格件表/CONVERSION CHART

								
MODEL	SUB-CLASS	NEEDLE CLAMP	NEEDLE PLATE	MAIN FEED DOG	DIFF. FEED DOG	PRESSER FOOT	SPREADER	NEEDLE
機型	規格	針座	針板	主送具	差送具	押具	上叉	針號
C007E-W122 /CH	240	M4240	E3524P	D4206	H4258	P0024	MH41	UY128GAS #11
	248	M4248	E3525P	D4206	H4258	P0025		
	256	M4356	E3826S	D4206	H4258	P0216		
	356	M4356	E3826P	D4206	H4258	P0216		
	364	M4364	E3827P	D4207	H4259	P0217		
C007E-U122 /CH	240	M4240	E3524P	D4206	H4258	P0314	—	UY128GAS #11
	248	M4248	E3525P	D4206	H4258	P0315		
	256	M4356	E3826S	D4206	H4258	P0416		
	356	M4356	E3826P	D4206	H4258	P0416		
	364	M4364	E3827P	D4207	H4259	P0417		
C007E-W122 CH/UTP(UTR)	240	M4240	E3524P	D4206	H4258	P0024	UT99	UY128GAS #11
	248	M4248	E3525P	D4206	H4258	P0025		
	256	M4356	E3826S	D4206	H4258	P0216		
	356	M4356	E3826P	D4206	H4258	P0216		
	364	M4364	E3827P	D4207	H4259	P0217		
C007E-U122 CH/UTQ(UTS)	240	M4240	E3524P	D4206	H4258	P0314	—	UY128GAS #11
	248	M4248	E3525P	D4206	H4258	P0315		
	256	M4356	E3826S	D4206	H4258	P0416		
	356	M4356	E3826P	D4206	H4258	P0416		
	364	M4364	E3827P	D4207	H4259	P0417		
C007E-W132 /CHE	240	M4240	E2324	D2109	H2219	P2904	MH41	UY128GAS #11
	248	M4248	E2325			P2905		
	356	M4356	E2326	D2110	H2220	P2906	MH41	UY128GAS #11
	364	M4364	E2327			P2907		
C007E-W132 CHE/UTP(UTR)	356 364	M4356 M4364	E2326 E2327	D2110	H2220	P2906 P2907	UT99	UY128GAS #11
C007E-W152 /CZ/UTP/RLQ	356	M4356	E4326P	D3216	H3262	P2416	UT99	UY128GAS #11
	364	M4364	E4327P	D3217	H3263	P2417		
C007E-W152 /CZ/CLA/UTP/RLQ	356 364	M4356 M4364	E4326P E4327P	D3216 D3217	H3262 H3263	P2416 P2417	UT99	UY128GAS #11
C007E-U152 /CZ/UTQ/RLQ	356 364	M4356 M4364	E4326P E4327P	D3216 D3217	H3262 H3263	P2416 P2417	—	UY128GAS #11
C007E-U152 /CZ/CLA/UTQ/RLQ	356 364	M4356 M4364	E4326P E4327P	D3216 D3217	H3262 H3263	P2416 P2417	—	UY128GAS #11
C007E-W152 /CZP/RLQ	356 364	M4356 M4364	E4326P E4327P	D3216 D3217	H3262 H3263	P2416 P2417	MH41	UY128GAS #11
C007E-U152 /CZP/RLQ	356 364	M4356 M4364	E4326P E4327P	D3216 D3217	H3262 H3263	P2416 P2417	—	UY128GAS #11
C007E-W152 CZP/RLQ/RLQ	356 364	M4356 M4364	E4326P E4327P	D3216 D3217	H3262 H3263	P2416 P2417	MH41	UY128GAS #11
C007E-U152 CZP/RLQ/RLQ	356 364	M4356 M4364	E4326P E4327P	D3216 D3217	H3262 H3263	P2416 P2417	—	UY128GAS #11
C007E-W222 /CQ	240	M4240	E4124P	D3216	H3362	P1814	MH41	UY128GAS #11
	248	M4248	E4125P	D3216	H3362	P1815		
	356	M4356	E4426P	D3216	H3362	P2116		
	364	M4364	E4427P	D3217	H3363	P2117		

簡車規格件表/CONVERSION CHART







								
MODEL	SUB-CLASS	NEEDLE CLAMP	NEEDLE PLATE	MAIN FEED DOG	DIFF. FEED DOG	PRESSER FOOT	SPREADER	NEEDLE
機型	規格	針座	針板	主送具	差送具	押具	上叉	針號
C007E-U222 /CQ	240 240 356 364	M4240 M4248 M4356 M4364	E4124P E4125P E4426P E4427P	D3216 D3216 D3216 D3217	H3362 H3362 H3362 H3363	P2314 P2315 P2616 P2617	—	UY128GAS #11
C007E-W322 /CC	356 364	M4356 M4364	E2826P E2827P	D2107L D2107L	H3259M H3259M	P1406 P1407	MH41	UY128GAS #11
C007E-U322 /CC	356 364	M4356 M4364	E2826P E2827P	D2107L D2107L	H3259M H3259M	P1406 P1407	—	UY128GAS #11
C007E-W322 CC/UTP(UTR)	356 364	M4356 M4364	E2826P E2827P	D2107L D2107L	H3259M H3259M	P1406 P1407	UT99	UY128GAS #11
C007E-U322 CC/UTQ(UTS)	356 364	M4356 M4364	E2826P E2827P	D2107L D2107L	H3259M H3259M	P1406 P1407	—	UY128GAS #11
C007E-W322 /CD	356 364	M4356 M4364	E3626P E3627P	D4206 D4207	H4158 H4159	P1406 P1407	MH41	UY128GAS #11
C007E-U322 /CD	356 364	M4356 M4364	E3626P E3627P	D4206 D4207	H4158 H4159	P1606 P1607	—	UY128GAS #11
C007E-W322 CD/UTP(UTR)	356 364	M4356 M4364	E3626P E3627P	D4206 D4207	H4158 H4159	P1406 P1407	UT99	UY128GAS #11
C007E-U322 CD/UTQ(UTS)	356 364	M4356 M4364	E3626P E3627P	D4206 D4207	H4158 H4159	P1606 P1607	—	UY128GAS #11
C007E-W322 /CE	356 364	M4356 M4364	E2626P E2627P	D2107	H3159	P1406 P1407	MH41	UY128GAS #11
C007E-U322 /CE	356 364	M4356 M4364	E2626P E2627P	D2107	H3159	P1406 P1407	—	UY128GAS #11
C007E-W322 CE/UTP(UTR)	356 364	M4356 M4364	E2626P E2627P	D2107	H3159	P1406 P1407	UT99	UY128GAS #11
C007E-U322 CE/UTQ(UTS)	356 364	M4356 M4364	E2626P E2627P	D2107	H3159	P1606 P1607	—	UY128GAS #11
C007E-U322 /CF	248	M4348	E2625P	D2106	H3158	P1605	—	UY128GAS #11
C007E-U322 CF/UTQ(UTS)	248	M4348	E2625P	D2106	H3158	P1605	—	UY128GAS #11
C007E-W512 /FE(FFC)	240 356 364	M4240 M4356 M4364	E3524 E3826 E3827	D4206 D4206 D4207	H4258 H4258 H4259	P2914 P3216 P3217	MH41	UY128GAS #11
C007E-U512 /FE(FFC)	240 356 364	M4240 M4356 M4364	E3524 E3826 E3827	D4206 D4206 D4207	H4258 H4258 H4259	P3414 P3716 P3717	—	UY128GAS #11
C007E-W522 /FE(FFC)/CRA /CL	356 364	M4356 M4364	E6426 E6427	D3222	H3268	P3826 P3827	MH41	UY128GAS #11
C007E-U522 /FE(FFC)/CRA /CL	356 364	M4356 M4364	E6426 E6427	D3222	H3268	P3826 P3827	—	UY128GAS #11

註：C007E-W/U322A-³⁵⁶/₃₆₄ /CC時，該針板與送金改用C007E-W/U122-³⁵⁶/₃₆₄之針板與送具。

※85.07.11

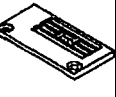
PS: C007E-W/U322A-³⁵⁶/₃₆₄ /CC be assembled C007E-W/U122-³⁵⁶/₃₆₄ Needle & Feed Dog.

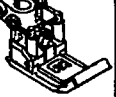





筒車規格件表/CONVERSION CHART

								
MODEL	SUB-CLASS	NEEDLE CLAMP	NEEDLE PLATE	MAIN FEED DOG	DIFF. FEED DOG	PRESSER FOOT	SPREADER	NEEDLE
機型	規格	針座	針板	主送具	差送具	押具	上叉	針號
C007E-W522 /FE(FFC)/CRB /CL	356 364	M4356 M4364	E6426 E6427	D3222	H3268	P3826 P3827	MH41	UY128GAS #11
C007E-U522 /FE(FFC)/CRB /CL	356 364	M4356 M4364	E6426 E6427	D3222	H3268	P3826 P3827	—	UY128GAS #11
C007E-W532 /CRA/UTP/CL /RLP/CX	356 364	M4356 M4364	E6426 E6427	D3222	H3268	P3816 P3817	UT99	UY128GAS #11
C007E-U532 /CRA/UTQ/CL /RLP/CX	356 364	M4356 M4364	E6426 E6427	D3222	H3268	P3816 P3817	—	UY128GAS #11
C007E-W542 /CFC(CFE)/CL	240 248	M4240 M4248	E2324 E2325	D2109	H2219	P2904 P2905	MH41	UY128GAS #11
	356 364	M4356 M4364	E2326 E2327	D2110	H2220	P2906 P2907	MH41	UY128GAS #11
C007E-U542 /CFC(CFE)/CL	240 248	M4240 M4248	E2324 E2325	D2109	H2219	P2904 P2905	—	UY128GAS #11
	356 364	M4356 M4364	E2326 E2327	D2110	H2220	P2906 P2907	—	UY128GAS #11
C007E-W812 /CRL/RL	356 364	M4356 M4364	E0226P E0227P	D2101 D2101	H2203 H2203	P2766 P2767	MH41	UY128GAS #11
C007E-U812 /CRL/RL	356 364	M4356 M4364	E0226P E0227P	D2101 D2101	H2203 H2203	P0966 P0967	—	UY128GAS #11
C007E-W812 /CRL/CHP/RL	356 364	M4356 M4364	E0226P E0227P	D2101 D2101	H2203 H2203	P2766 P2767	MH41	UY128GAS #11
C007E-U812 /CRL/CHP/RL	356 364	M4356 M4364	E0226P E0227P	D2101 D2101	H2203 H2203	P0966 P0967	—	UY128GAS #11
C007E-W812 CRL/CHP/UTP /RL	356 364	M4356 M4364	E0226P E0227P	D2101 D2101	H2203 H2203	P2766 P2767	UT99	UY128GAS #11
C007E-U812 CRL/CHP/UTQ /RL	356 364	M4356 M4364	E0226P E0227P	D2101 D2101	H2203 H2203	P0966 P0967	—	UY128GAS #11
C007E-W822 /CRL/CY/CL /RL	356 364	M4356 M4364	E0226P E0227P	D2101 D2101	H2203 H2203	P2766 P2767	MH41	UY128GAS #11
C007E-U822 /CRL/CY/CL /RL	356 364	M4356 M4364	E0226P E0227P	D2101 D2101	H2203 H2203	P0966 P0967	—	UY128GAS #11
C007E-W822 CRL/CY/UTP /CL/RL	356 364	M4356 M4364	E0226P E0227P	D2101 D2101	H2203 H2203	P2766 P2767	UT99	UY128GAS #11

*85.07.11

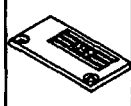
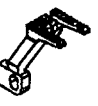
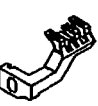
筒車規格件表/CONVERSION CHART

P4

								
MODEL	SUB-CLASS	NEEDLE CLAMP	NEEDLE PLATE	MAIN FEED DOG	DIFF. FEED DOG	PRESSER FOOT	SPREADER	NEEDLE
機型	規格	針座	針板	主送具	差送具	押具	上叉	針號
C007E-U822 CRL/CY/UTQ /CL/RL	356 364	M4356 M4364	E0226P E0227P	D2101 D2101	H2203 H2203	P0966 P0967	—	UY128GAS #11

#85.07.11

PARTS LIST FOR MH GROUP

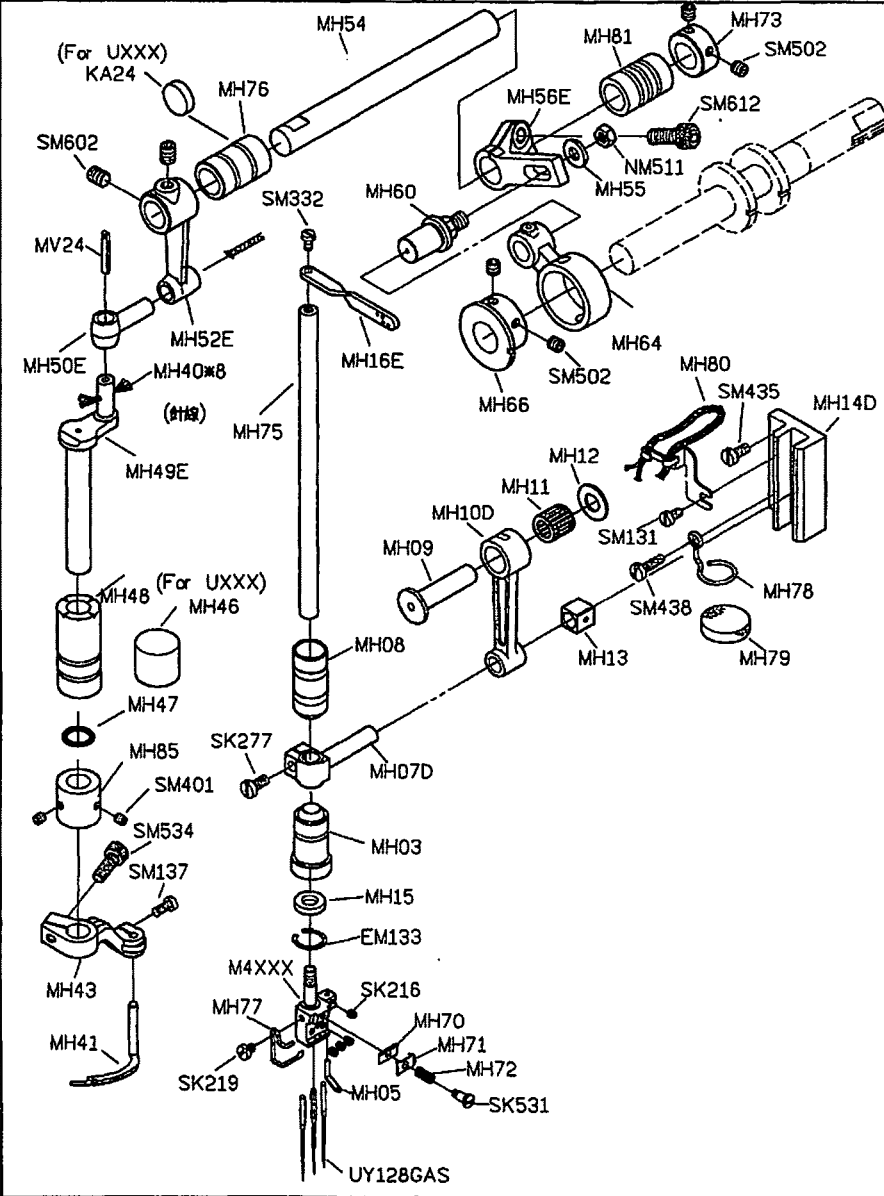

PARTS LIST FOR MJ GROUP

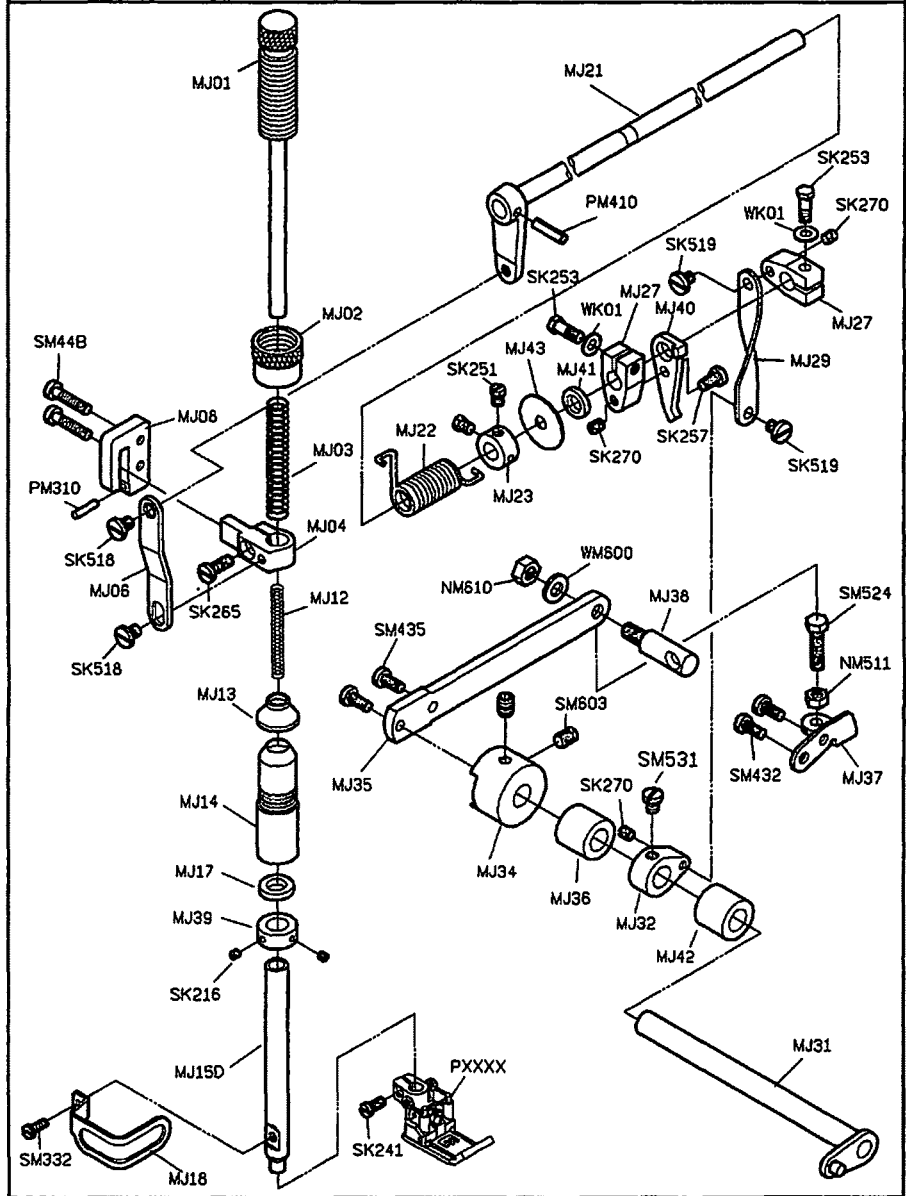

PARTS LIST FOR MK GROUP

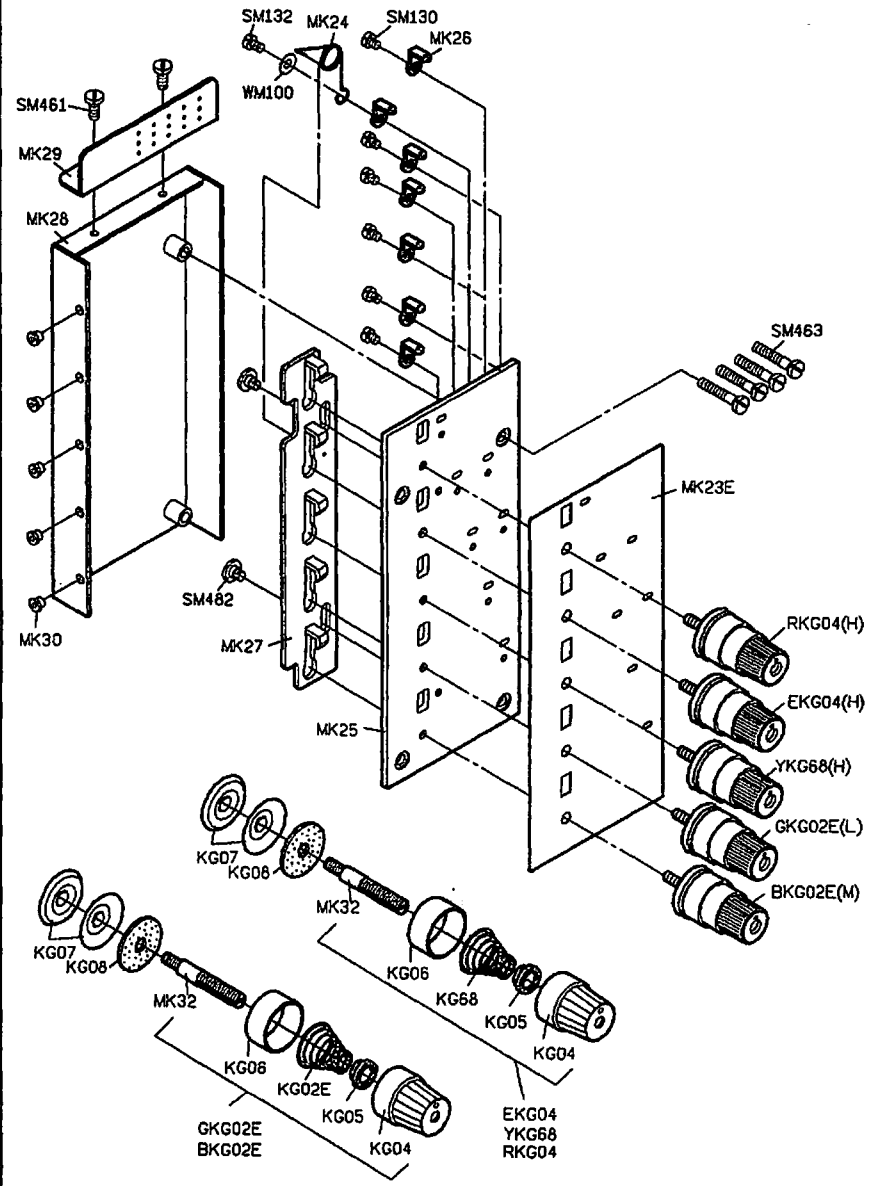

85.04.05

PARTS LIST FOR MN GROUP

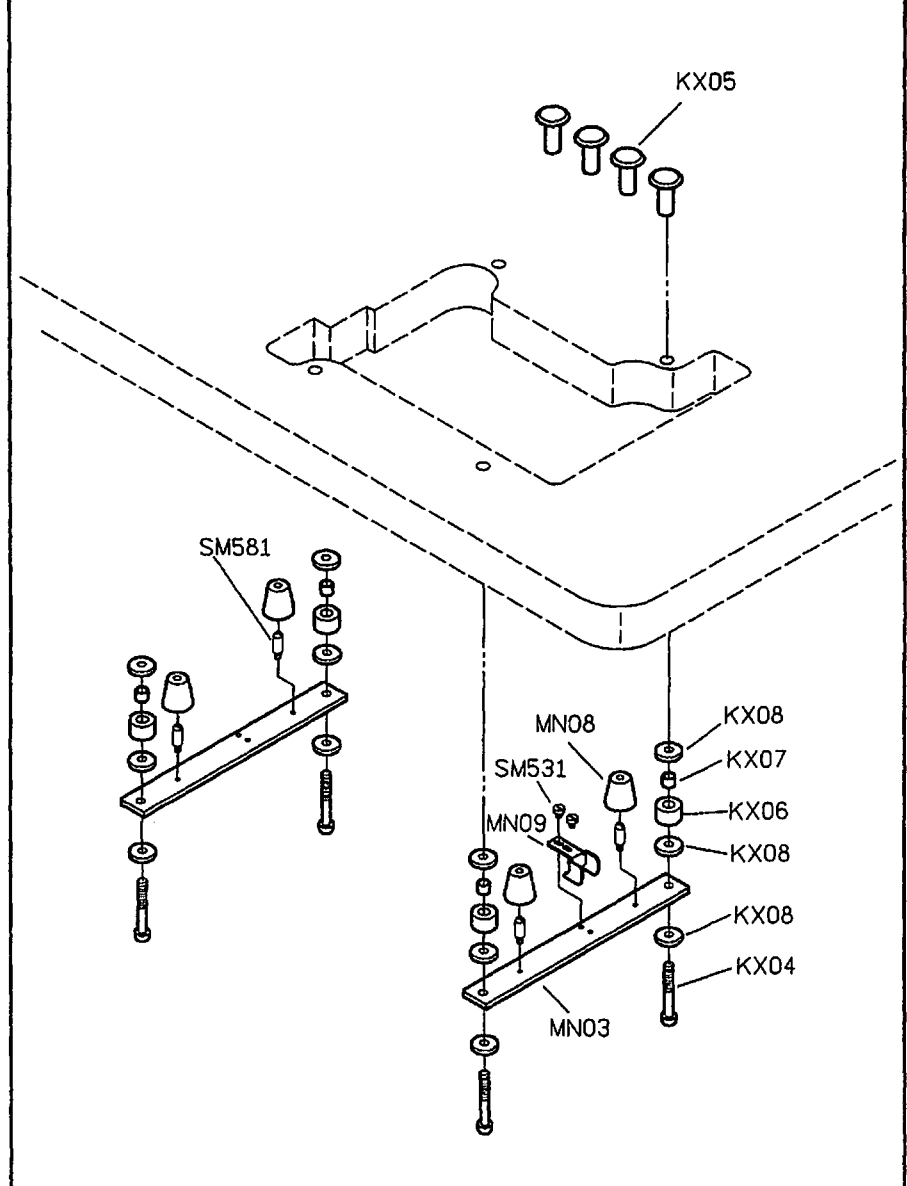

83.9.30

PARTS LIST FOR MQ GROUP

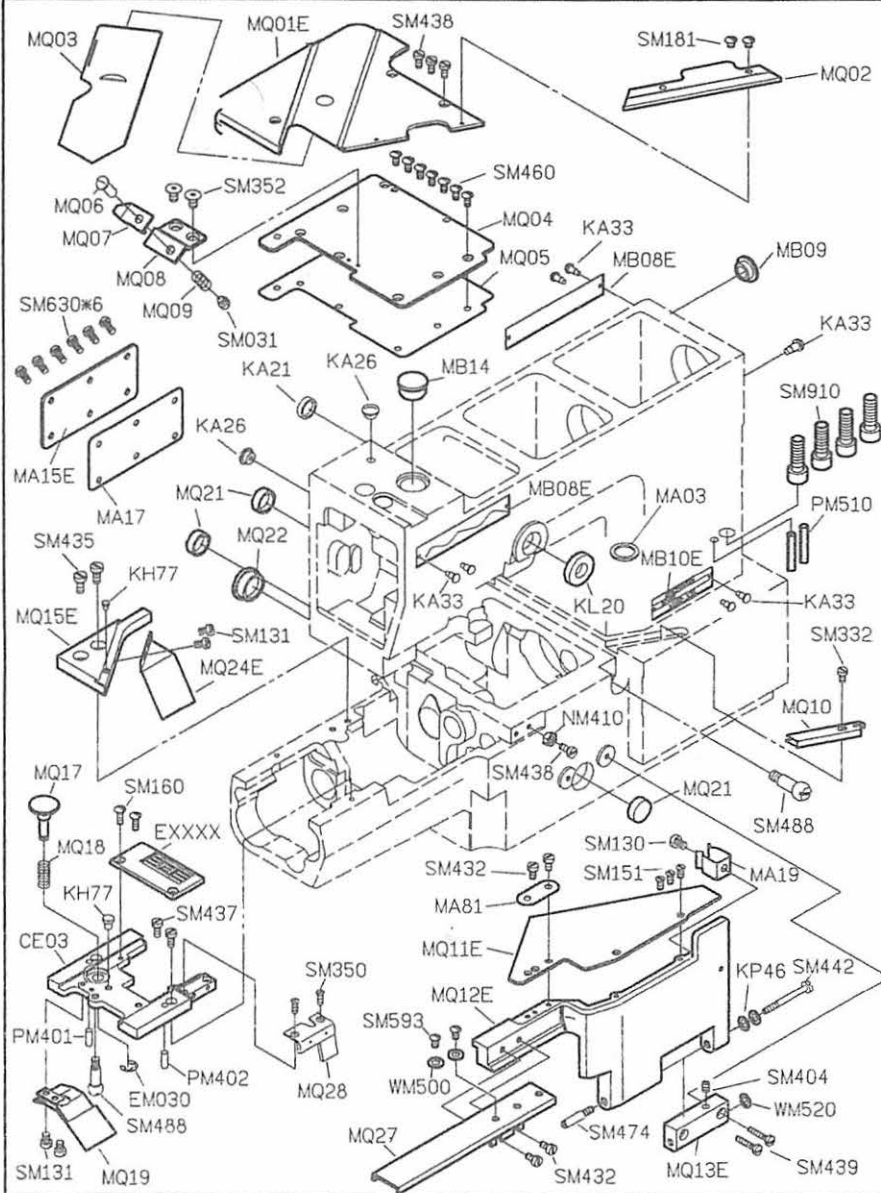

*85.01.26

PARTS LIST FOR MR GROUP

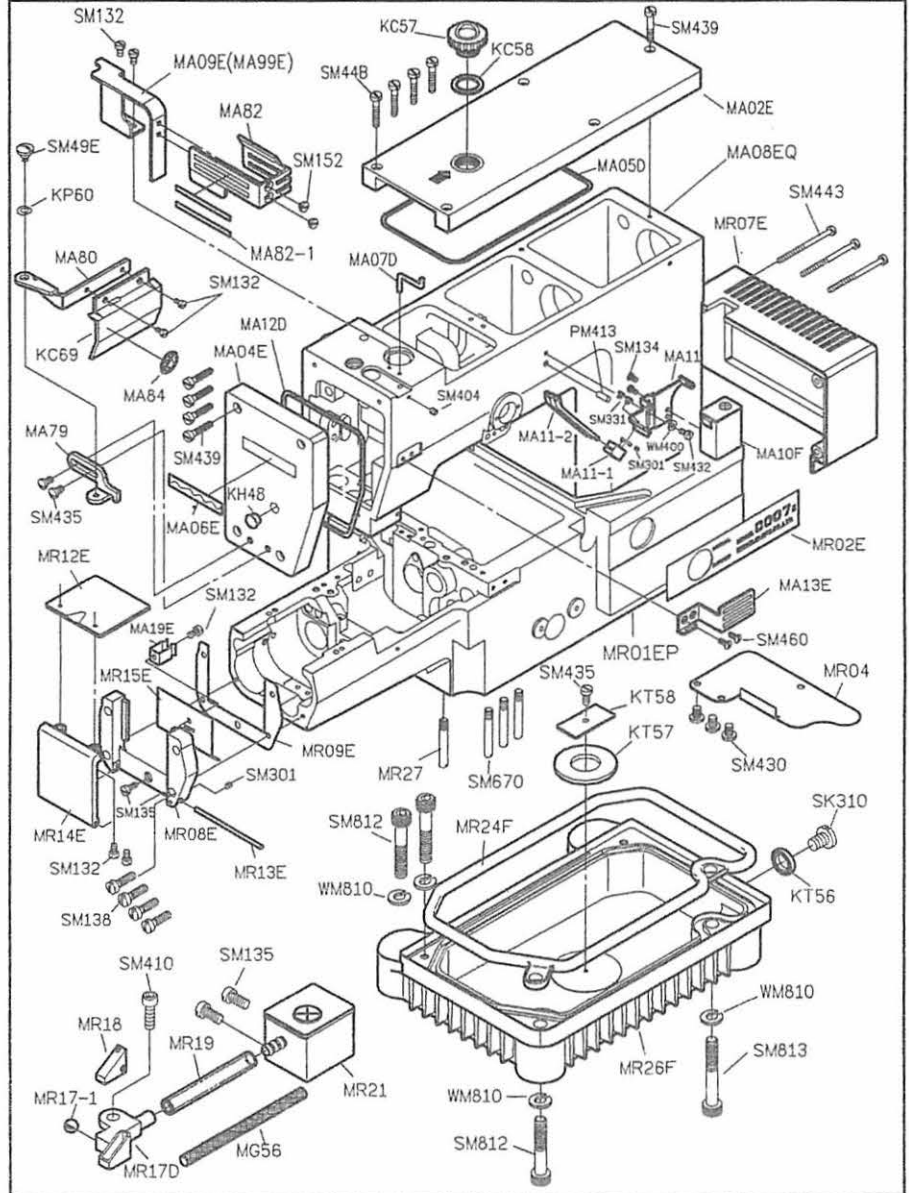

85,04,22

PARTS LIST FOR MU GROUP

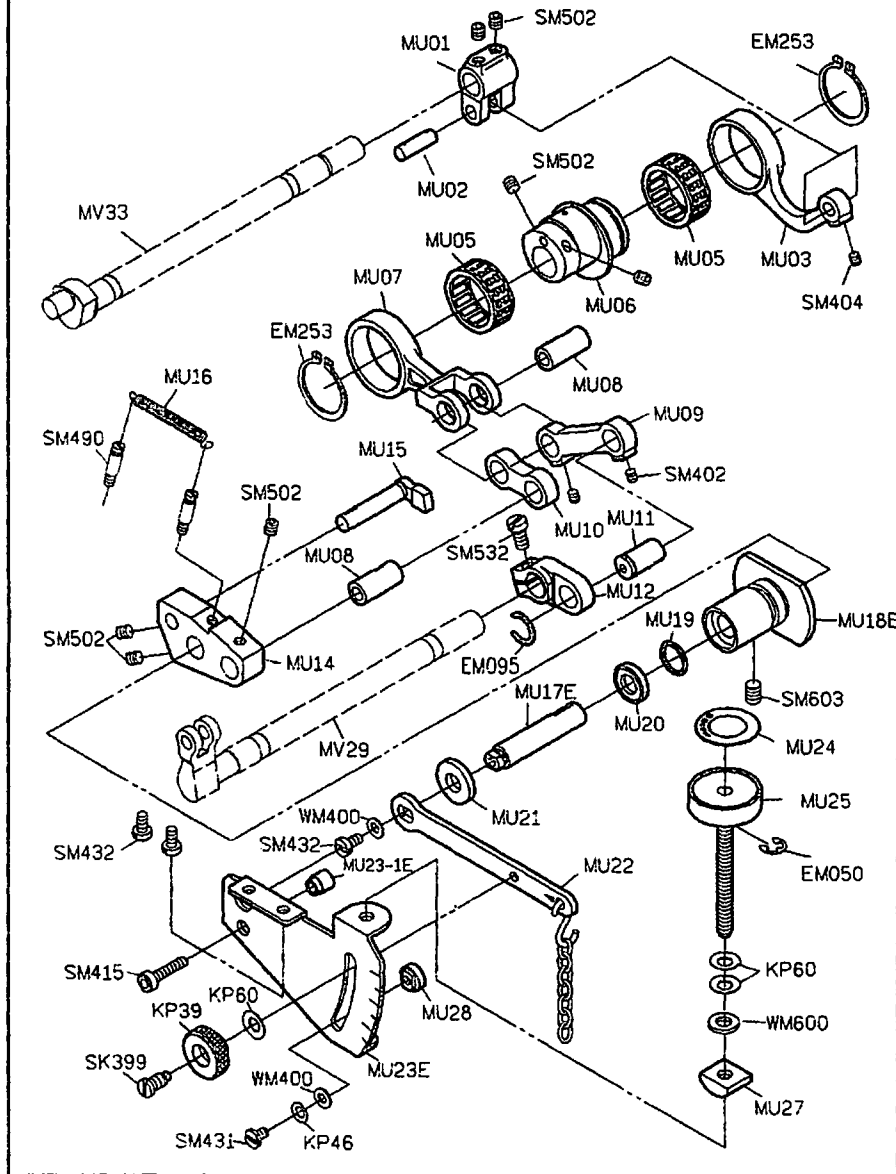

*84.10.05

PARTS LIST FOR MV GROUP

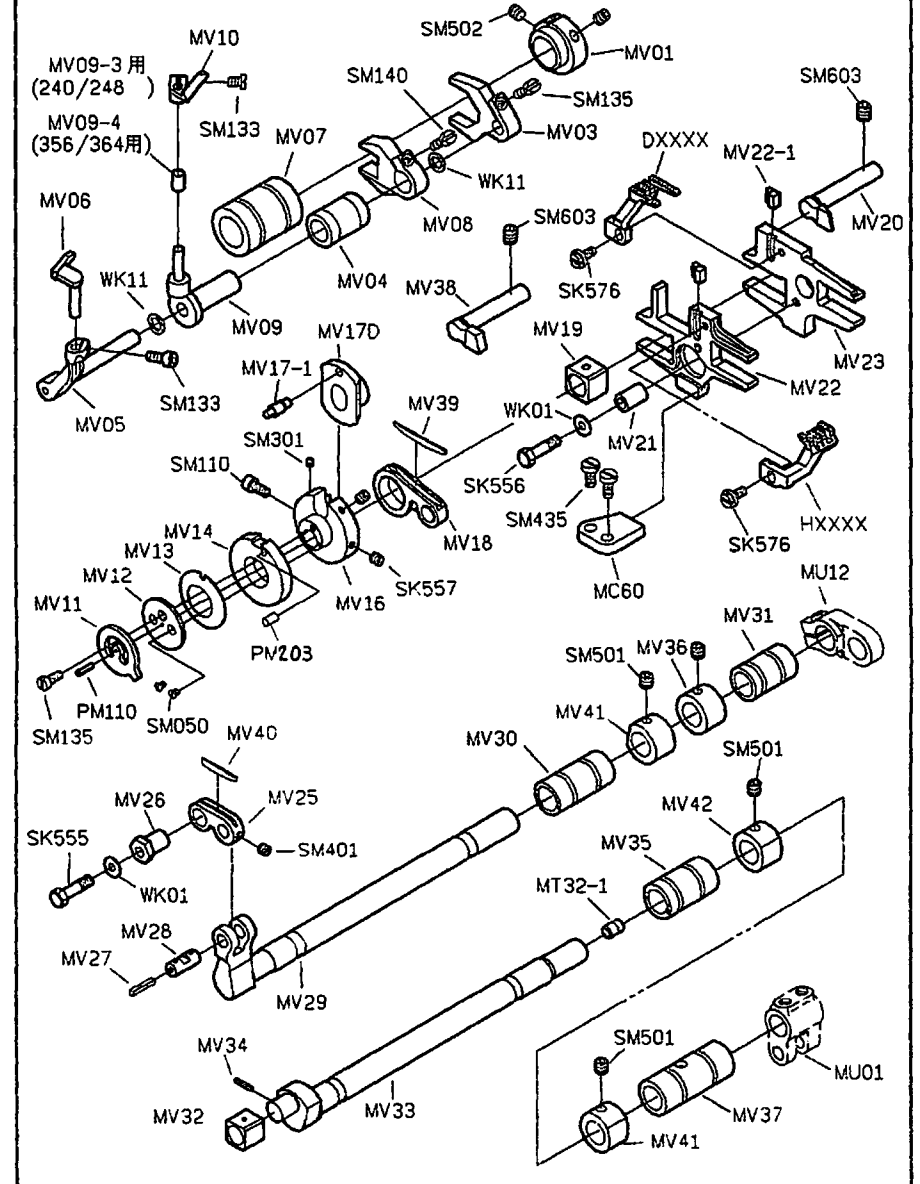

85.3.16

PARTS LIST FOR MW GROUP

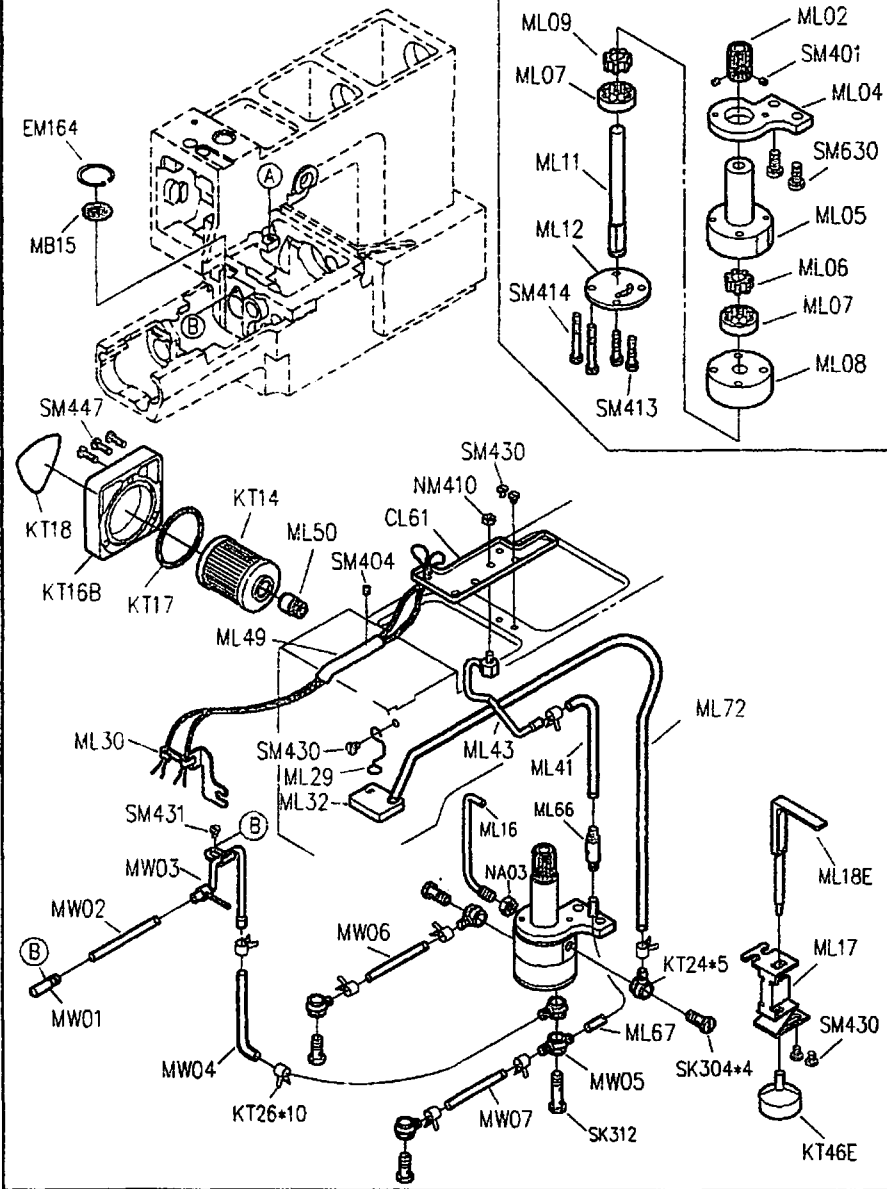

85,4,25

PARTS LIST FOR MY GROUP

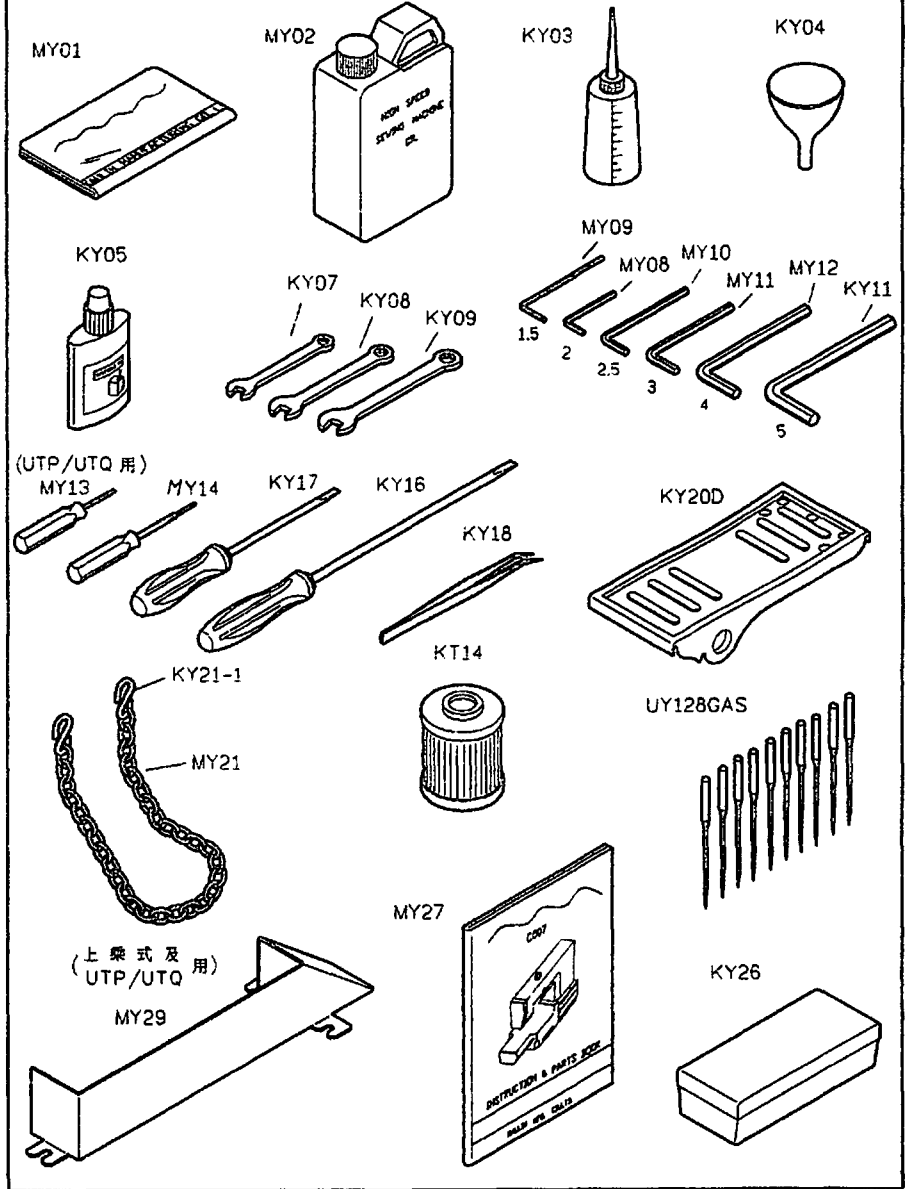

84.6.6

SIRUBA®

PARTS.NO. MY32 AUG.96/

*SUBJECT TO CHANGE WITHOUT NOTICE.

From the library of: Superior Sewing Machine & Supply LLC