

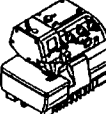

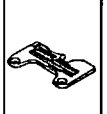

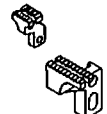

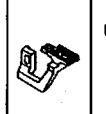



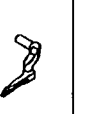
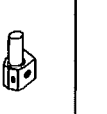
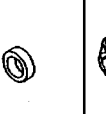
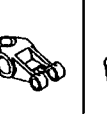
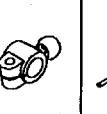

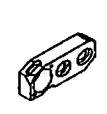
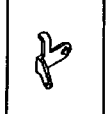
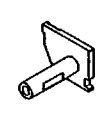
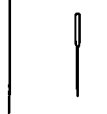
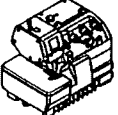

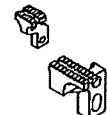



700K 拷克車規格件表 / CONVERSION CHART

															
機 型 MODEL	針板 NEEDLE PLATE	送具 FEED DOG	送具 FEED DOG	押具 PRESSER FOOT	勾 針 LOOPER	針留 NEEDLE CLAMP	束 子 COLLER	衝 程 CRANK	衝 程 CRANK	大 心 Crankshaft	勾針連桿座 Upper Looper Holder	過線器 Bracket	下刀架 Lower Knife Holder	針 號 NEEDLE	
737K-503M2-04	E222	D210	D207	H204	P201-14A	LP231	KG231K-E	KJ204	KF203-E	KJ206-E	KD201	KJ236	KJ219	KR209	DCX27#11
737K-504F1-04	E206	D201	D207	H201	P201-14A	LP225	KG231K-E	KJ204	KF203-E	KJ206-E	KD201	KJ236	KJ219	KR209	DCX27#9
737K-504F1-15	E233K	D201	D217	H201	P214P-A	LP225	KG231K-E	KJ204	KF203-E	KJ206-E	KD201	KJ236	KJ219	KR209	DCX27#9
737K-504F2-02/GA-L	E233K	D201	D217	H201	P214P-2A	LP225	KG231K-E	KJ204	KF203-E	KJ206-E	KD201	KJ236	KJ219	KR209	DCX27#9
737K-504M1-15	E207	D201	D209	H201	P211-A	LP225	KG231K-E	KJ204	KF203-E	KJ206-E	KD201	KJ236	KJ219	KR209	DCX27#9
737K-504M1-15VT	E207	D201	D209	H201	P211-A	LP225	KG231K-E	KJ204	KF203-E	KJ206-E	KD201	KJ236	KJ219	KR209	DCX27#9
737K-504M2-04	E222	D210	D207	H204	P201-14A	LP225	KG231K-E	KJ204	KF203-E	KJ206-E	KD201	KJ236	KJ219	KR209	DCX27#11
737K-504M2-04CT	E222	D210	D207	H204	P201-14A	LP225	KG231K-E	KJ204	KF203-E	KJ206-E	KD201	KJ236	KJ219	KR209	DCX27#11
737K-504M2-04EC	E222	D210	D207	H204	P201-14A	LP225	KG231K-E	KJ204	KF203-E	KJ206-E	KD201	KJ236	KJ219	KR209	DCX27#11
737K-504M2-04LFC-3	E222	D210	D207	H204	P216-3	LP225	KG231K-E	KJ204	KF203-E	KJ206-E	KD201	KJ236	KJ219	KR209	DCX27#11
737K-504M2-04LFC-3/EC	E222	D210	D207	H204	P216-3	LP225	KG231K-E	KJ204	KF203-E	KJ206-E	KD201	KJ236	KJ219	KR209	DCX27#11
737K-504M2-04TR	E222	D210	D207	H204	P216-3	LP225	KG231K-E	KJ204	KF203-E	KJ206-E	KD201	KJ236	KJ219	KR209	DCX27#11
737K-504M2-04TR/EC	E222	D210	D207	H204	P216-3	LP225	KG231K-E	KJ204	KF203-E	KJ206-E	KD201	KJ236	KJ219	KR209	DCX27#11
737K-504M2-04VT	E222	D210	D207	H204	P201-14A	LP225	KG231K-E	KJ204	KF203-E	KJ206-E	KD201	KJ236	KJ219	KR209	DCX27#11
737K-WR/LFC-3	E246					LP225	KG231K-E	KJ204	KF203-E	KJ206-E	KD201	KJ236	KJ219		DCX27#11
737K-504M3-04	E220	D210	D209	H204	P201-14A	LP225	KG231K-E	KJ204	KF203-E	KJ206-E	KD201	KJ236	KJ219	KR209	DCX27#11
737K-504M3-05	E221	D210	D209	H204	P201-14A	LP225	KG231K-E	KJ204	KF203-E	KJ206-E	KD201	KJ236	KJ219	KR209	DCX27#11
737K-504M3-05CT	E221	D210	D209	H204	P201-14A	LP225	KG231K-E	KJ204	KF203-E	KJ206-E	KD201	KJ236	KJ219	KR209	DCX27#11
737K-504M3-05PZ	E221	D210	D209	H204	P257-A	LP225	KG231K-E	KJ204	KF203-E	KJ206-E	KD201	KJ236	KJ219	KR209	DCX27#18
737K-504M3-05VT	E221	D210	D209	H204	P201-14A	LP225	KG231K-E	KJ204	KF203-E	KJ206-E	KD201	KJ236	KJ219	KR209	DCX27#11
737K-504M5-04BK	E232	D203	D207	H203	P202-2A	LP225	KG231K-E	KJ204	KF203-E	KJ206-E	KD201	KJ236	KJ219	KR209	DCX27#11
737K-504M5-04BK-1	E232	D203	D207	H203	P202-2A	LP225	KG231K-E	KJ204	KF203-E	KJ206-E	KD201	KJ236	KJ219	BK239	DCX27#11
737K-504M5-04BK/VT	E232	D203	D207	H203	P202-2A	LP225	KG231K-E	KJ204	KF203-E	KJ206-E	KD201	KJ236	KJ219	KR209	DCX27#11
737K-504M5-04BK-1/VT	E232	D203	D207	H203	P202-2A	LP225	KG231K-E	KJ204	KF203-E	KJ206-E	KD201	KJ236	KJ219	BK239	DCX27#11
737K-505F1-04	E206	D201	D207	H201	P203-A	LP225	KG231K-E	KJ204	KF203-E	KJ206-E	KD201	KJ236	KJ219	KR209	DCX27#9
737K-505F1-04VT	E206	D201	D207	H201	P203-A	LP225	KG231K-E	KJ204	KF203-E	KJ206-E	KD201	KJ236	KJ219	KR209	DCX27#9
747K-512M1-25	E208	D210	D207	H204	P201-A	LP228	KG242K-E	KJ204	KF215-E	KJ203-E	KD201	KJ208	KJ219	KR209	DCX27#11*2
747K-512M1-25CT	E208	D210	D207	H204	P201-A	LP228	KG242K-E	KJ204	KF215-E	KJ203-E	KD201	KJ208	KJ219	KR209	DCX27#11*2
747K-512M1-34	E236	D210	D207	H204	P214-A	LP228	KG254K-E	KJ204	KF215-E	KJ203-E	KD201	KJ208	KJ219	KR209	DCX27#14*2
747K-514F1-24	E212	D210	D207	H204	P201-A	LP226	KG242K-E	KJ234K	KF203-E	KJ203-E	KD201	KJ208	KJ219	KR209	DCX27#11*2
747K-514H4-24GA	E229	D202	D207	H202	P204-A	LP226	KG242K-E	KJ234K	KF203-E	KJ203-E	KD201	KJ208	KJ219	KR209	DCX27#11*2
747K-514H4-24GA/CT	E229	D202	D207	H202	P204-A	LP226	KG242K-E	KJ234K	KF203-E	KJ203-E	KD201	KJ208	KJ219	KR209	DCX27#11*2
747K-514H4-24GA/EC	E229	D202	D207	H202	P204-A	LP226	KG242K-E	KJ234K	KF203-E	KJ203-E	KD201	KJ208	KJ219	KR209	DCX27#11*2

700K 拷克車規格件表 / CONVERSION CHART

															
機 型 MODEL	針板 NEEDLE PLATE	送具 FEED DOG	送具 FEED DOG	押具 PRESSER FOOT	勾 針 LOOPER	針留 NEEDLE CLAMP	束 子 COLLER	衝 程 CRANK	衝 程 CRANK	大 心 Crankshaft	勾針連桿座 Upper Looper Holder	過線器 Bracket	下刀架 Lower Knife Holder	針 號 NEEDLE	
747K-514H4-24GA/P	E229	D202	D207	H202	P204P-A	LP226	KG242K-E	KJ234K	KF203-E	KJ203-E	KD201	KJ208	KJ219	KR209	DCX27#11*2
747K-514M2-24	E229	D210	D207	H204	P201-A	LP226	KG242K-E	KJ234K	KF203-E	KJ203-E	KD201	KJ208	KJ219	KR209	DCX27#11*2
747K-514M2-24CT	E229	D210	D207	H204	P201-A	LP226	KG242K-E	KJ234K	KF203-E	KJ203-E	KD201	KJ208	KJ219	KR209	DCX27#11*2
747K-514M2-24EC	E229	D210	D207	H204	P201-A	LP226	KG242K-E	KJ234K	KF203-E	KJ203-E	KD201	KJ208	KJ219	KR209	DCX27#11*2
747K-514M2-24LFC-3	E229	D210	D207	H204	P216-4	LP226	KG242K-E	KJ234K	KF203-E	KJ203-E	KD201	KJ208	KJ219	KR209	DCX27#11*2
747K-514M2-24LFC-3/EC	E229	D210	D207	H204	P216-4	LP226	KG242K-E	KJ234K	KF203-E	KJ203-E	KD201	KJ208	KJ219	KR209	DCX27#11*2
747K-514M2-24TG	E229	D210	D207	H204	P254J-4A	LP226	KG242K-E	KJ234K	KF203-E	KJ203-E	KD201	KJ208	KJ219	KR209	DCX27#11*2
747K-514M2-24TG/EC	E229	D210	D207	H204	P254J-4A	LP226	KG242K-E	KJ234K	KF203-E	KJ203-E	KD201	KJ208	KJ219	KR209	DCX27#11*2
747K-514M2-24VT	E229	D210	D207	H204	P201-A	LP226	KG242K-E	KJ234K	KF203-E	KJ203-E	KD201	KJ208	KJ219	KR209	DCX27#11*2
747K-514M2-24BK	E247	D203	D207	H203	P202-A	LP226	KG242K-E	KJ234K	KF203-E	KJ203-E	KD201	KJ208	KJ219	KR209	DCX27#11*2
747K-514M2-25	E208	D210	D207	H204	P201-A	LP226	KG242K-E	KJ234K	KF203-E	KJ203-E	KD201	KJ208	KJ219	KR209	DCX27#11*2
747K-514M2-25CT	E208	D210	D207	H204	P201-A	LP226	KG242K-E	KJ234K	KF203-E	KJ203-E	KD201	KJ208	KJ219	KR209	DCX27#11*2
747K-514M2-25TG	E208	D210	D207	H204	P254J-4A	LP226	KG242K-E	KJ234K	KF203-E	KJ203-E	KD201	KJ208	KJ219	KR209	DCX27#11*2
747K-514M2-28	E230	D210	D207	H204	P201-8A	LP227A	KG242K-E	KJ204K	KF203-E	KJ203-E	KD201A	KJ228	KJ238	KR209	DCX27#11*2
747K-514M4-23	E209	D210	D207	H204	P201-2A	LP226	KG242K-E	KJ234K	KF203-E	KJ203-E	KD201	KJ208	KJ219	KR209	DCX27#11*2
747K-514M4-23/CT	E209	D210	D207	H204	P201-2A	LP226	KG242K-E	KJ234K	KF203-E	KJ203-E	KD201	KJ208	KJ219	KR209	DCX27#11*2
747K-514M5-23BK	E210	D203	D207	H203	P202-A	LP226	KG242K-E	KJ234K	KF203-E	KJ203-E	KD201	KJ208	KJ219	KR209	DCX27#11*2
747K-514M5-23BK-1	E210	D203	D207	H203	P202-A	LP226	KG242K-E	KJ234K	KF203-E	KJ203-E	KD201	KJ208	KJ219	BK239	DCX27#11*2
747K-514M5-23BK/VT	E210	D203	D207	H203	P202-A	LP226	KG242K-E	KJ234K	KF203-E	KJ203-E	KD201	KJ208	KJ219	KR209	DCX27#11*2
747K-514M5-23BK-1/VT	E210	D203	D207	H203	P202-A	LP226	KG242K-E	KJ234K	KF203-E	KJ203-E	KD201	KJ208	KJ219	BK239	DCX27#11*2
747K-514M7-24	E226	D212	D207	H210	P201-A	LP230	KG242K-E	KJ204K	KF203-E	KJ203-E	KD201A	KJ228	KJ238	KR209	DCX27#16*2
747K-514M7-24BK	E247	D203	D207	H203	P202-A	LP230	KG242K-E	KJ204K	KF203-E	KJ203-E	KD201A	KJ228	KJ238	KR209	DCX27#16*2
747K-514M7-24BK-1	E247	D203	D207	H203	P202-A	LP230	KG242K-E	KJ204K	KF203-E	KJ203-E	KD201A	KJ228	KJ238	BK239	DCX27#16*2
747K-514M7-24CT	E226	D212	D207	H210	P201-A	LP230	KG242K-E	KJ204K	KF203-E	KJ203-E	KD201A	KJ228	KJ238	KR209	DCX27#16*2
747K-514M7-24TG	E226	D212	D207	H210	P254J-4A	LP230	KG242K-E	KJ204K	KF203-E	KJ203-E	KD201A	KJ228	KJ238	KR209	DCX27#16*2
747K-514M7-25	E225	D212	D207	H210	P201-A	LP230	KG242K-E	KJ204K	KF203-E	KJ203-E	KD201A	KJ228	KJ238	KR209	DCX27#16*2
747K-514M7-25BK	E248	D203	D207	H203	P202-A	LP230	KG242K-E	KJ204K	KF203-E	KJ203-E	KD201A	KJ228	KJ238	KR209	DCX27#16*2
747K-514M7-25BK-1	E248	D203	D207	H203	P202-A	LP230	KG242K-E	KJ204K	KF203-E	KJ203-E	KD201A	KJ228	KJ238	BK239	DCX27#16*2
747K-514M7-25CT	E225	D212	D207	H210	P201-A	LP230	KG242K-E	KJ204K	KF203-E	KJ203-E	KD201A	KJ228	KJ238	KR209	DCX27#16*2
747K-514M7-25TG	E225	D212	D207	H210	P254J-4A	LP230	KG242K-E	KJ204K	KF203-E	KJ203-E	KD201A	KJ228	KJ238	KR209	DCX27#16*2
757K-401M1/TW	E237	D219		H219	P506-A		KG253K-E	KJ204	KF203-E	KJ206-E	KD201	TW201			DCX27#14*1
757K-516H4-35GA	E213	D204	D207	H205	P508J-A	LP226	KG253K-E	KJ204	KF203-E	KJ206-E	KD201	KJ236	KJ219	KR219	DCX27#14*2
757K-516H4-35GA/EC	E213	D204	D207	H205	P508J-A	LP226	KG253K-E	KJ204	KF203-E	KJ206-E	KD201	KJ236	KJ219	KR219	DCX27#14*2

700K PARTS LIST FOR KA GROUP P.1/1

MODEL	700K/KD	988/988D
PARTS NO	KC230	KC231

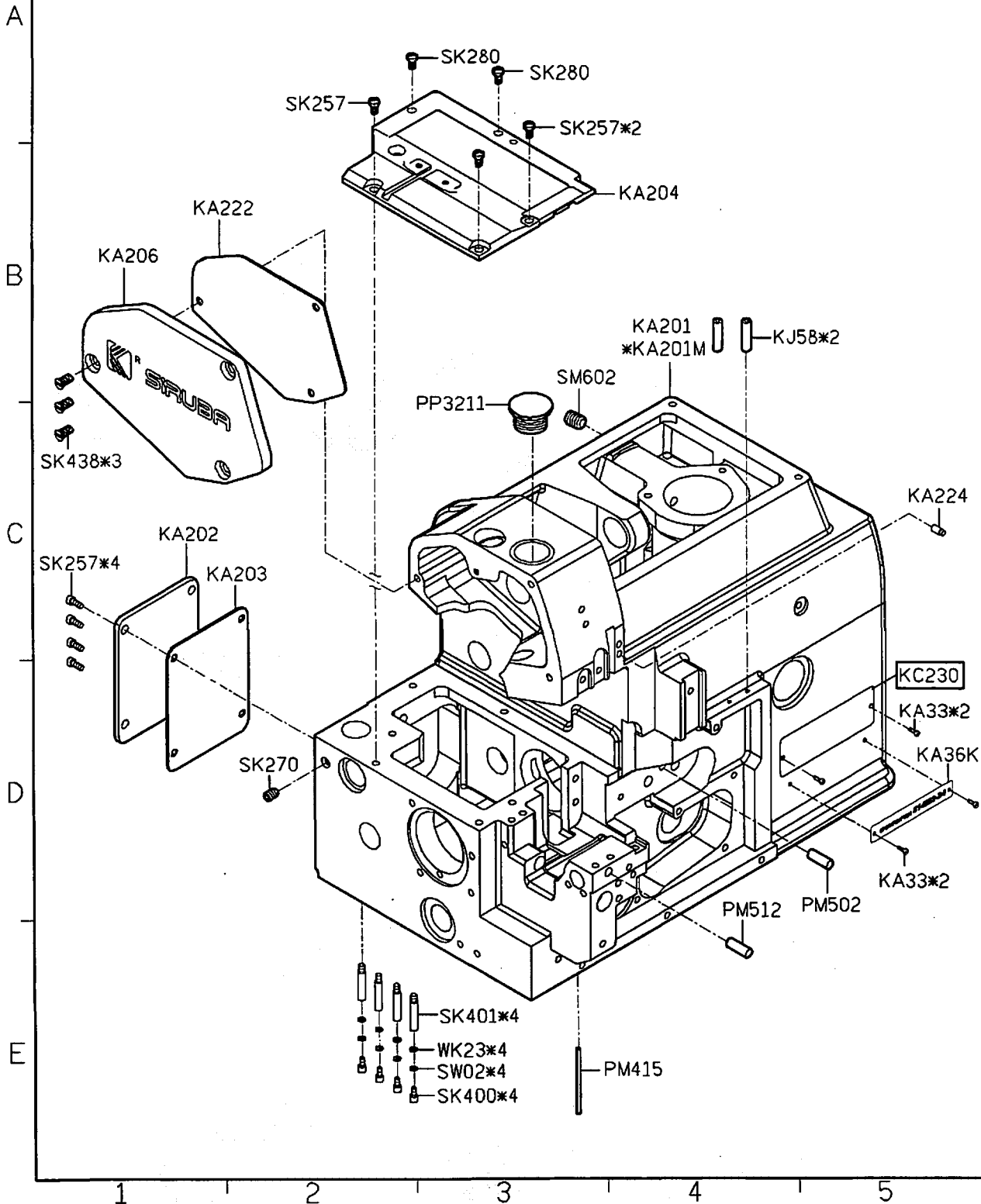

FOR 700K/700KD/988/988D
 *USE FOR 700KD/988D

10/06/02

700K PARTS LIST FOR KB GROUP P.1/1

A
B
C
D
E

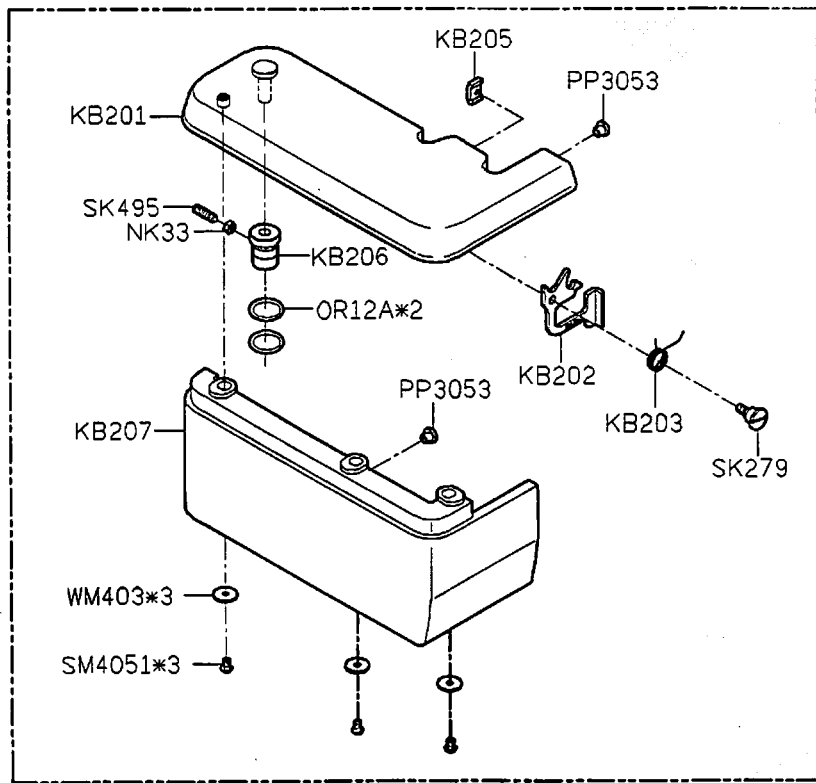
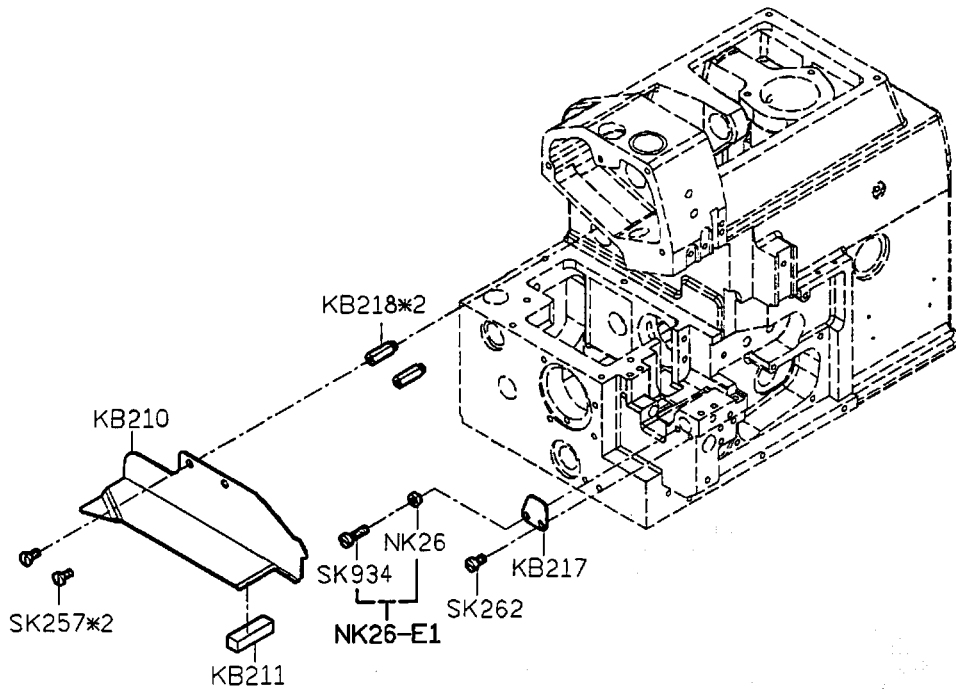

From the library of: Superior Sewing Machine & Supply LLC

700K PARTS LIST FOR KC GROUP P.1/1

FOR 700K/988

FOR 700KD/988D

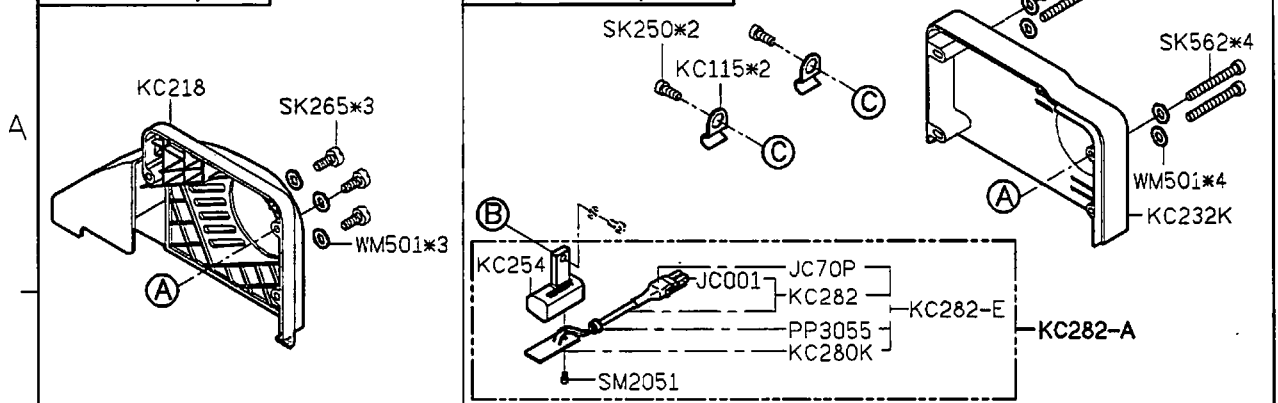

MODEL	700K	700KD	988	988D
PARTS NO	KC38J	KC38J	KC38C	KC38DC
	SK262	SK265	SK265	SK265

MODEL	3線/4線	5線/6線
PARTS NO	KC209	KC219
	KC206-4	KC206-5

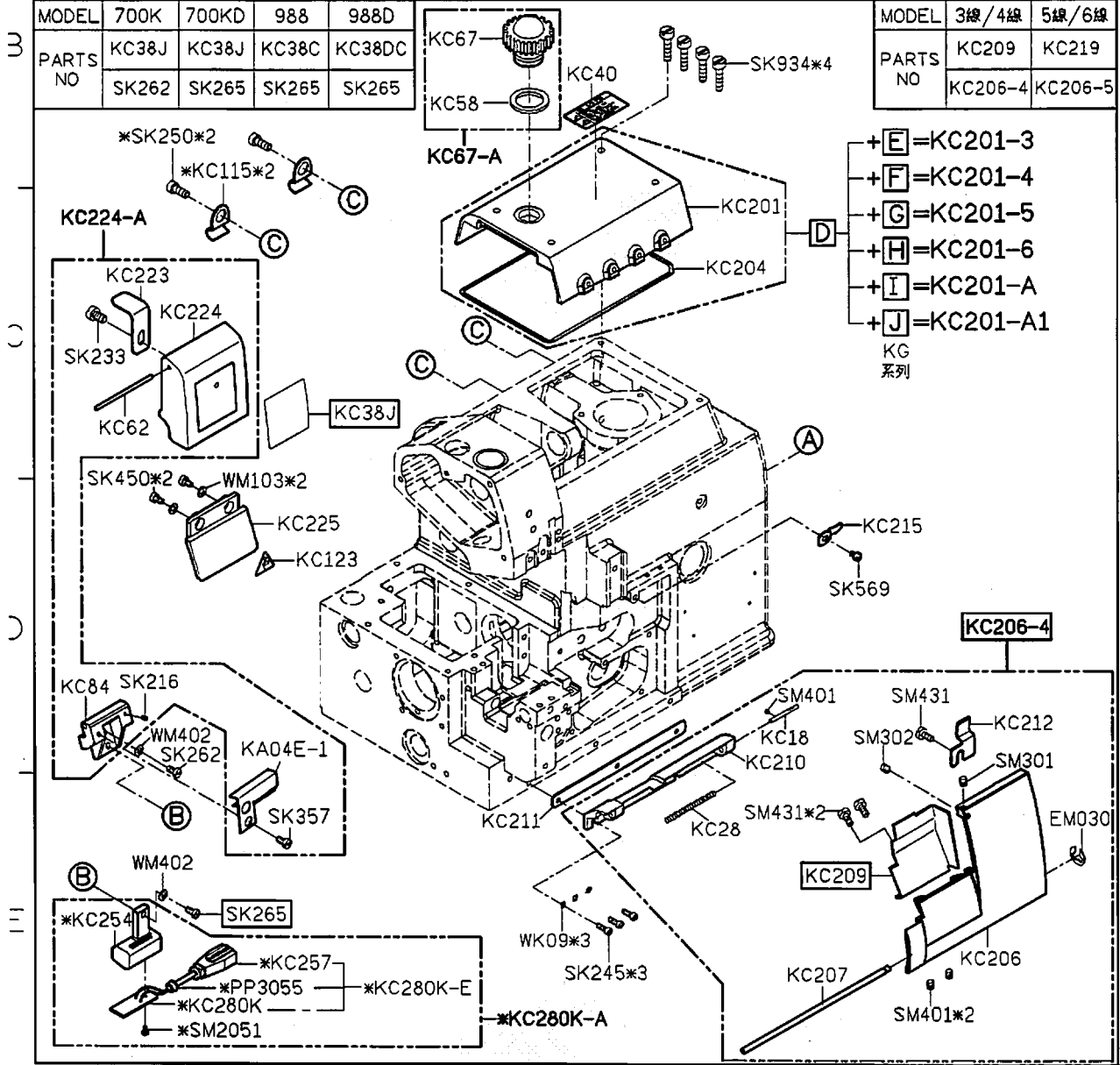

FOR 700K/700KD/988/988D
*USE FOR 988

10/06/02

700K PARTS LIST FOR KD GROUP P.1/1

FOR 700K/988

FOR 700KD/988D

A

B

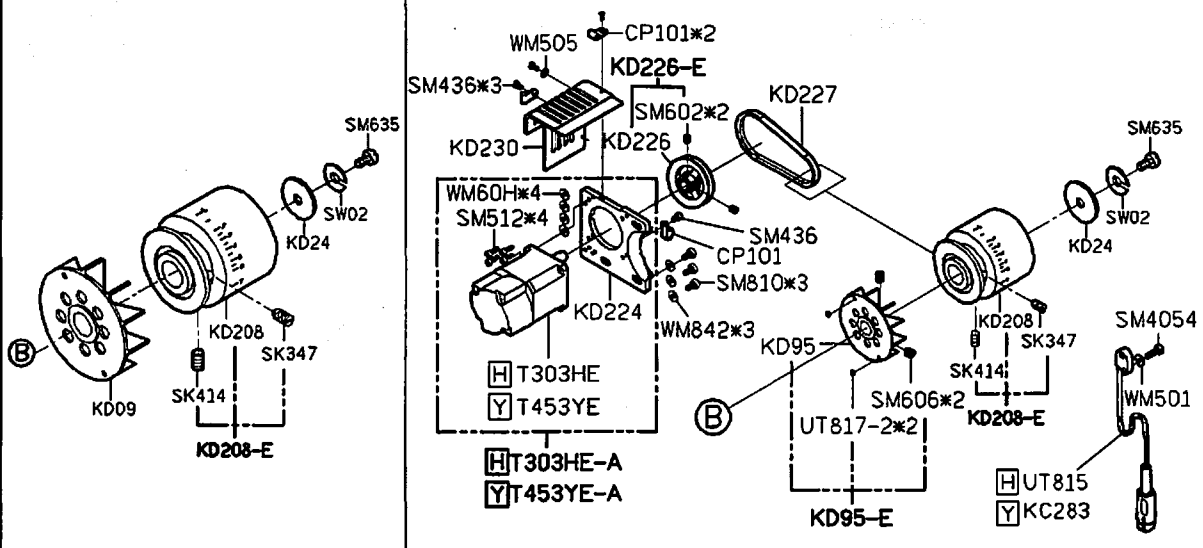

MODEL	3線/4線	5線/6線
PARTS NO	KD204 SM6007 SK241*3	KD217 KD220 SK539*2 SK872*1

C

D

E

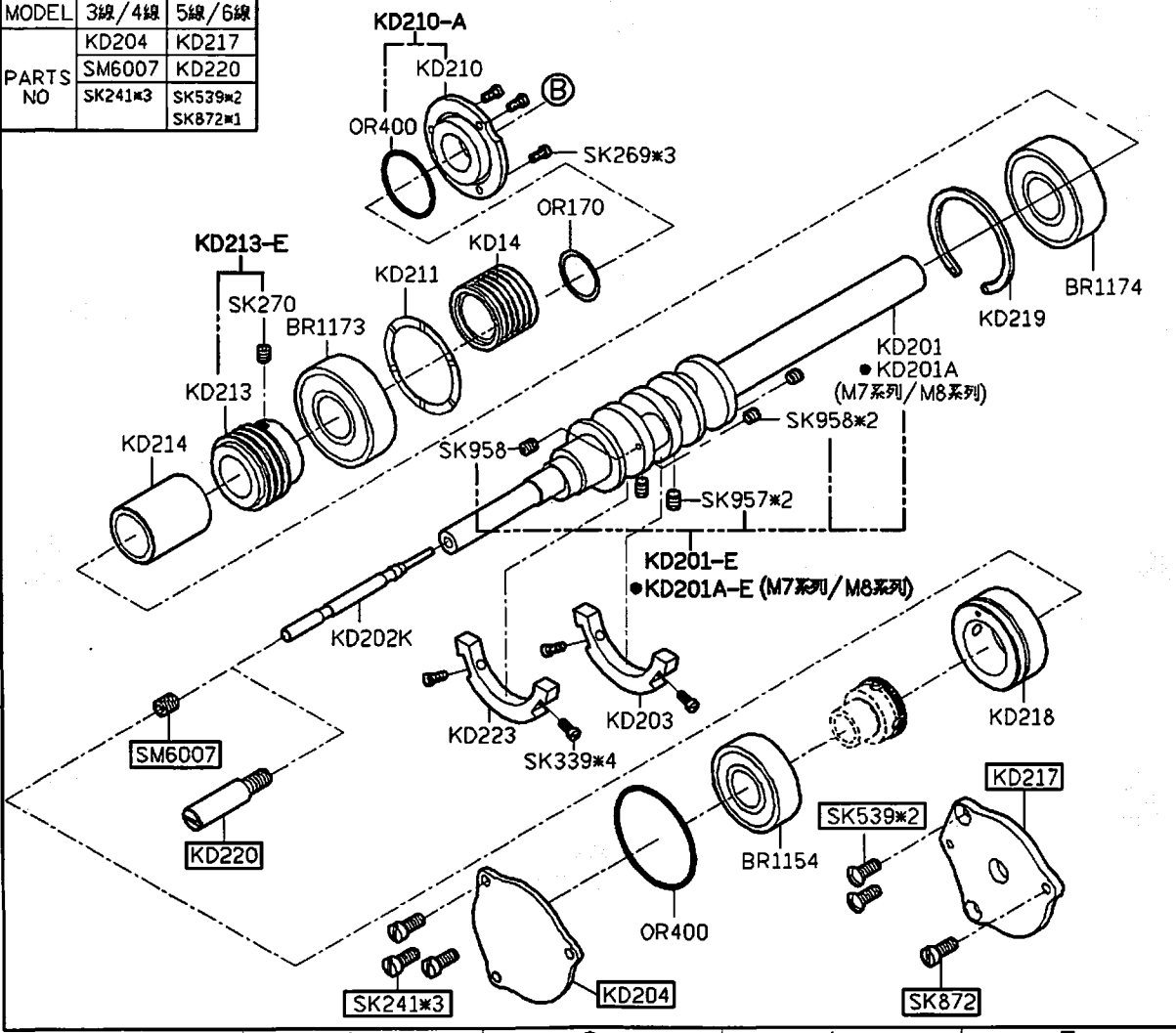

FOR 700K/700KD/988/988D

FOR H機種
 FOR Y機種

10/11/27

700K PARTS LIST FOR KF GROUP P.1/1

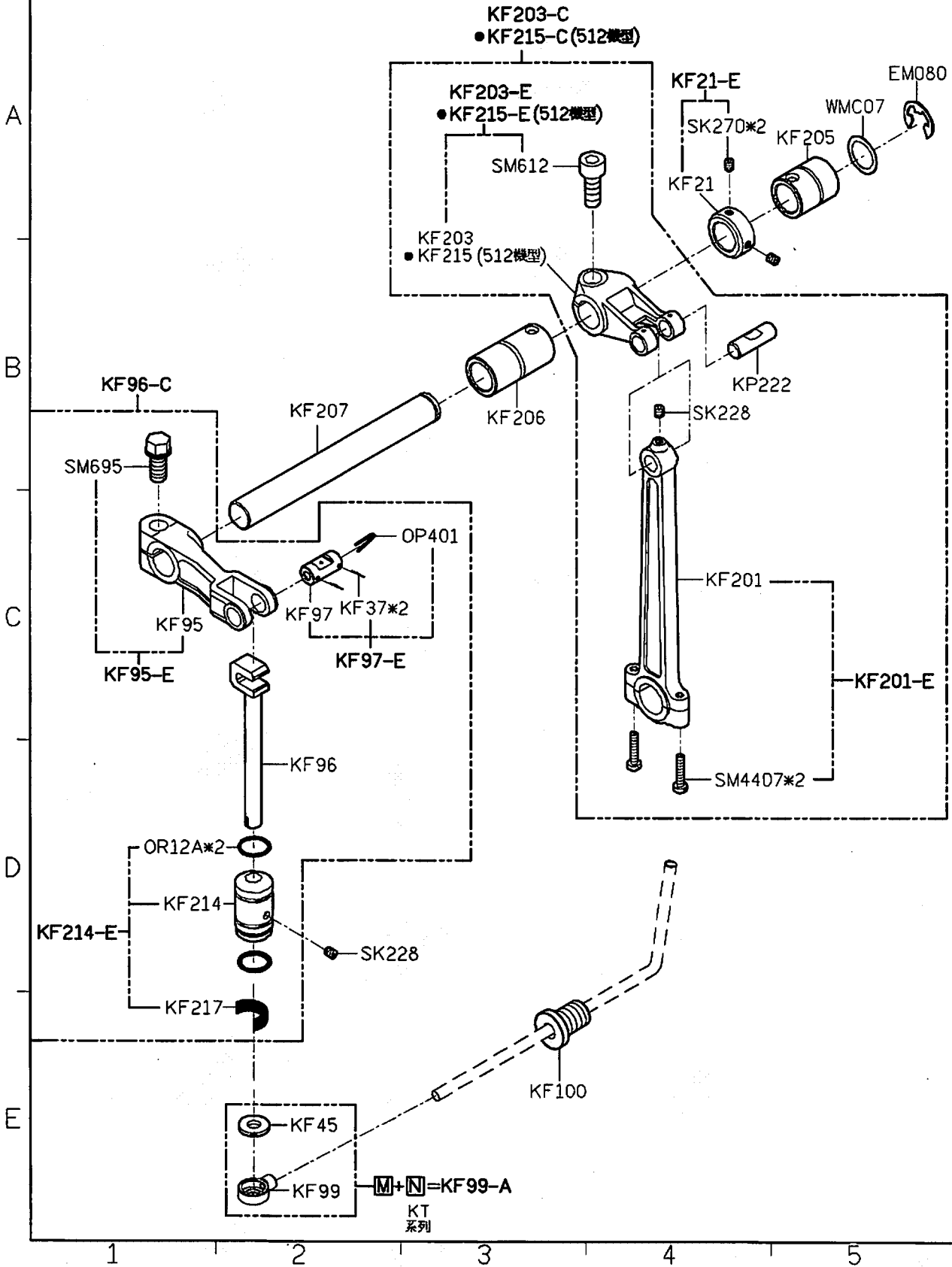

700K PARTS LIST FOR KG GROUP P.1/1

MODEL	3線	4線	5線	6線
KG233	KG211	KG233	KG211	
KG248	KG213	KG236	KG249	
KG250	KG221	KG243	KG251	
KG222	KG222	KG245	KG245	
KG225	KG225	KG261	KG261	
KG201	KG201	KG244	KG244	
KG93	KG92	KG94	KG94	
SK216	SK216	SK216*2	SK216*2	
SK250N	SK250N	SK250N*2	SK250N*2	
SK437N	SK437N	SK437	SK437	
SM251	SM251	SM250	SM250	
KG212-3	KG212-4	KG241-5	KG241-5	
KG223-4	KG223-4	KG223-5	KG223-5	

A PARTS NO

FOR(3線/4線)

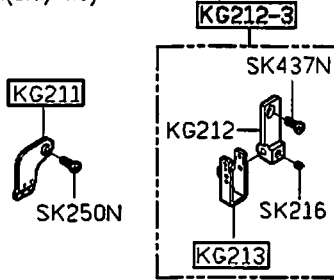

FOR(5線/6線)

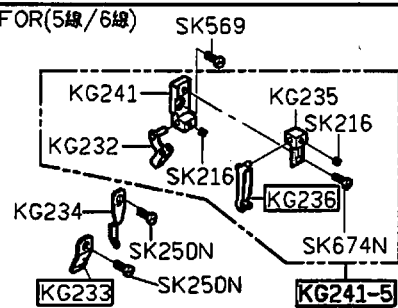

MODEL	PARTS NO				
M7系列	KG02E	KG04F-G1	KG04F-Y2		J
700K/700KD	KG02E	KG04F-G1	KG04F-Y2	UK12-G1	KG04F-A2 F G J
988/988D	KG96	KG04F-G	KG04F-Y	UK12-G	KG04F-A3 E H I

B

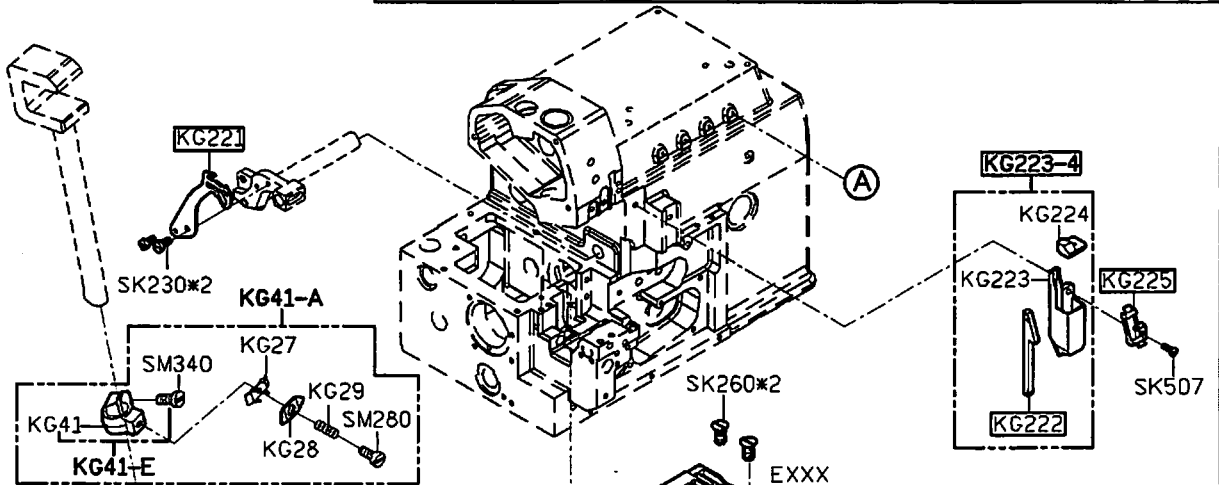

C

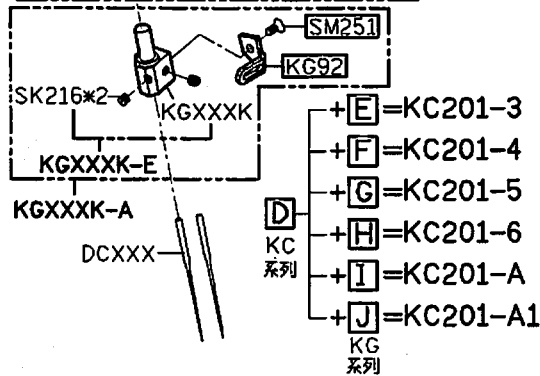

D

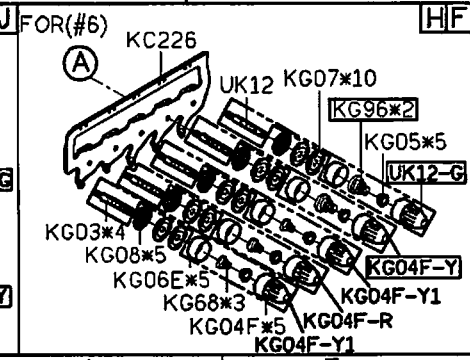
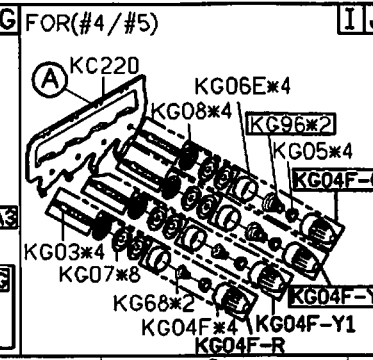
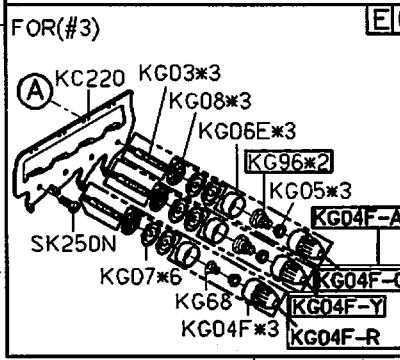

FOR 700K/700KD/988/988D 10/06/02

700K PARTS LIST FOR KJ GROUP P.1/1

MODEL	3線/5線	4線/6線	4線M7/M8系列/M2-28
PARTS NO	KJ204	KJ234K	KJ204K
	KJ206	KJ203	KJ203
	KJ206-E	KJ203-E	KJ203-E
	KJ206-C	KJ203-C	KJ203-C
	KJ236	KJ208	KJ228
	KJ236-C	KJ208-C	KJ228-C
	KJ219		KJ238

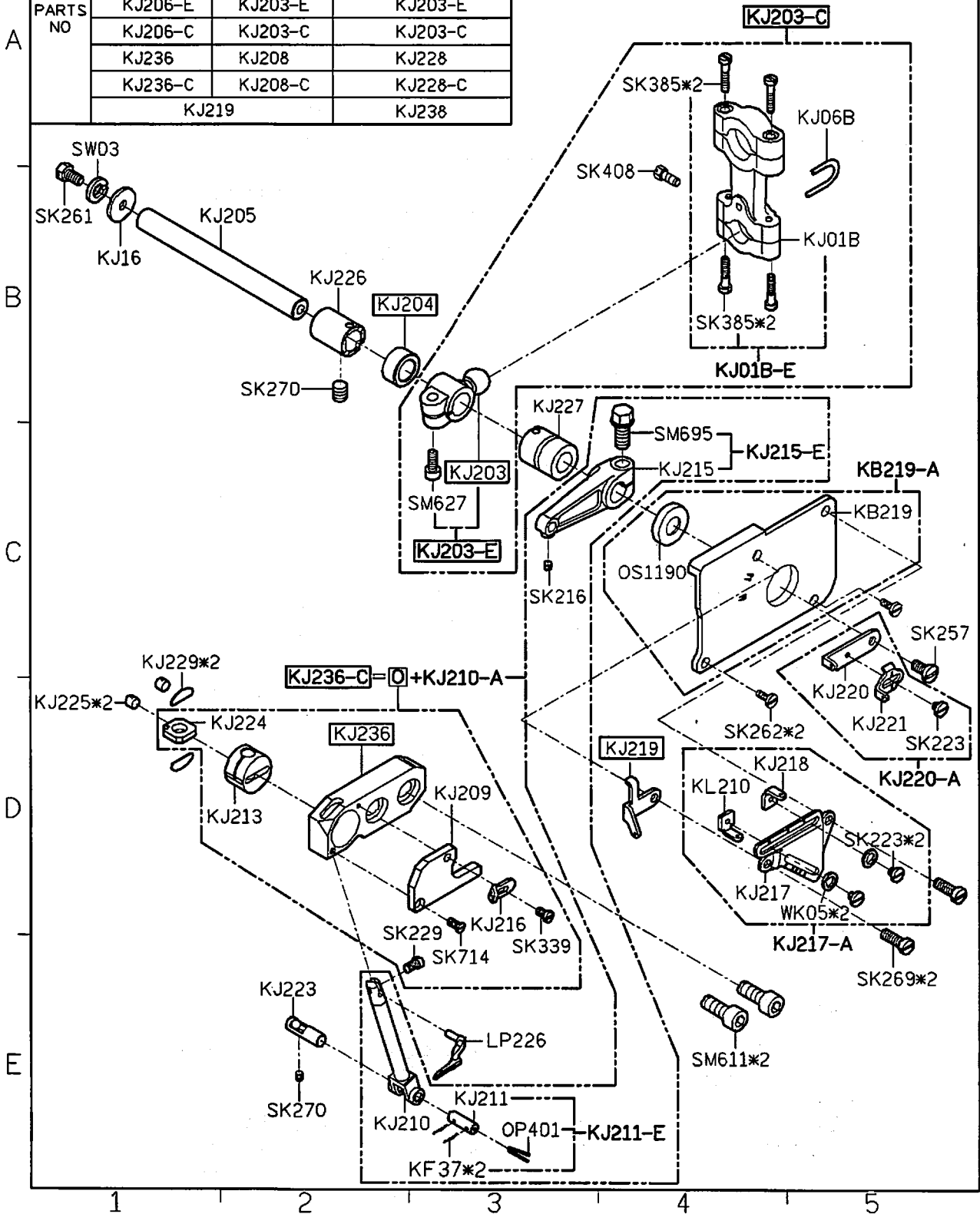

FOR 700K/700KD/988/988D

10/06/02

700K PARTS LIST FOR KL GROUP P.1/1

MODEL	3線/4線	5線/6線	M7系列
	KL202		KL202A
	KL201-A		KL201-A1
PARTS NO	KL205	KL209	
		SK270	
	KL205-E	KL209-E	
	KL205-C	KL209-C	

KL KL KM
系列 系列 系列
P+**R**+**S**=KL209-C
 KL KL
系列 系列
P+**Q**=KL205-C

A
3
C
D
三

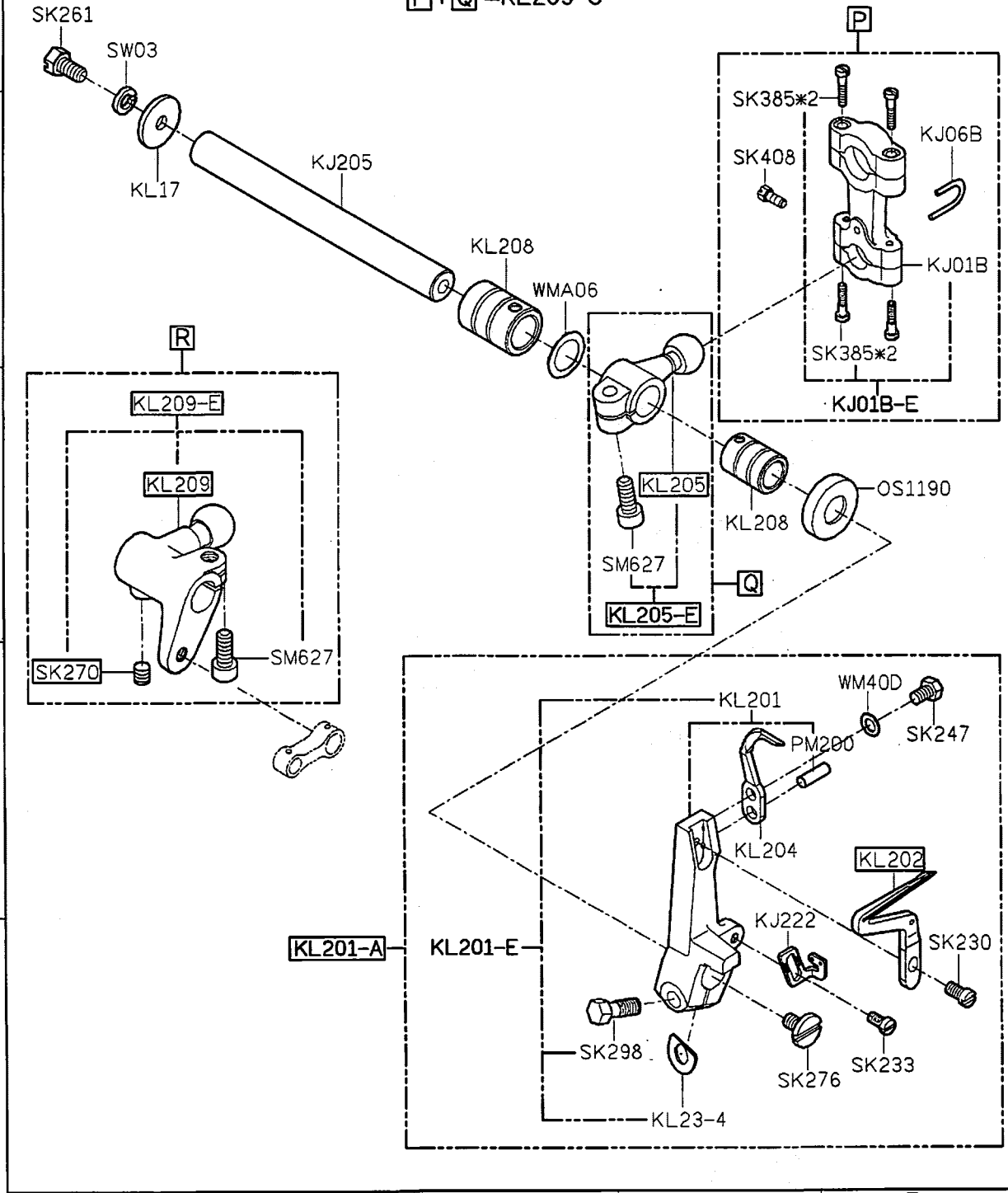

700K PARTS LIST FOR KM GROUP P.1/1

KM KL KL
 系列 系列 系列
 $\boxed{S} + \boxed{R} + \boxed{P} = \text{KL209-C}$

A
B
C
D
E

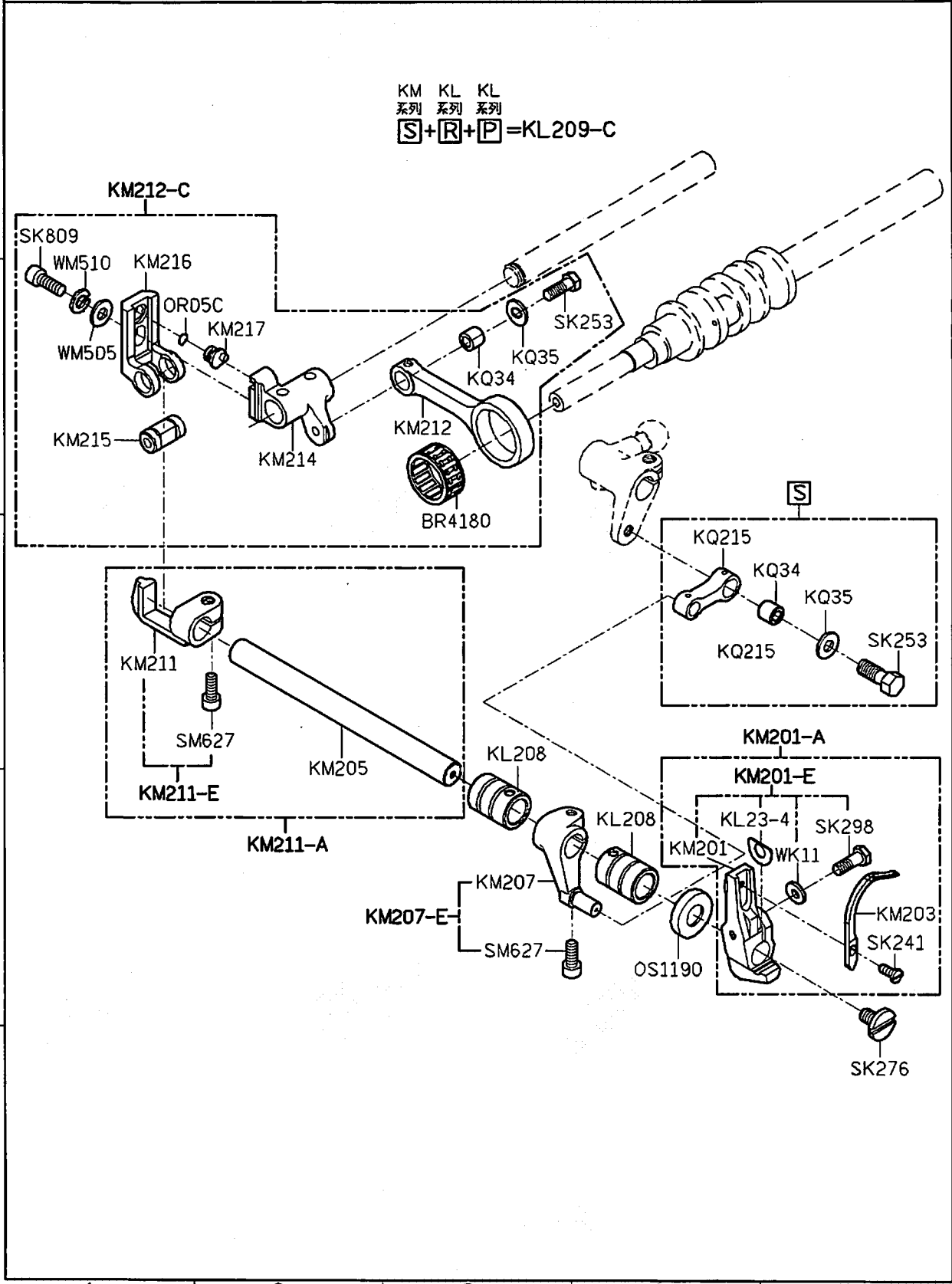

From the library of: Superior Sewing Machine & Supply LLC

700K PARTS LIST FOR KN GROUP P.1/1

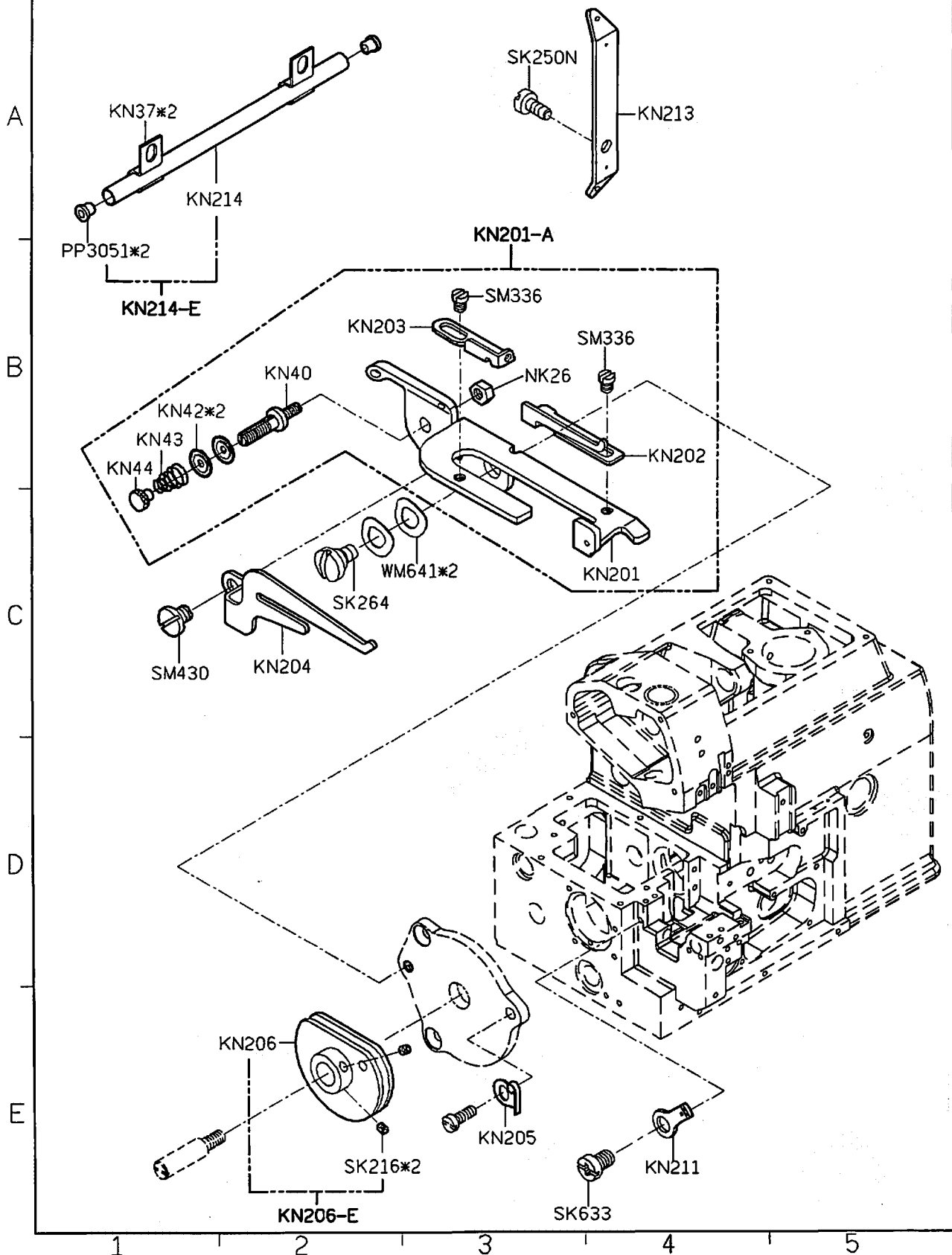

FOR 700K/700KD/988/988D

10/06/02

From the library of: Superior Sewing Machine & Supply LLC

700K PARTS LIST FOR KP GROUP P.1/1

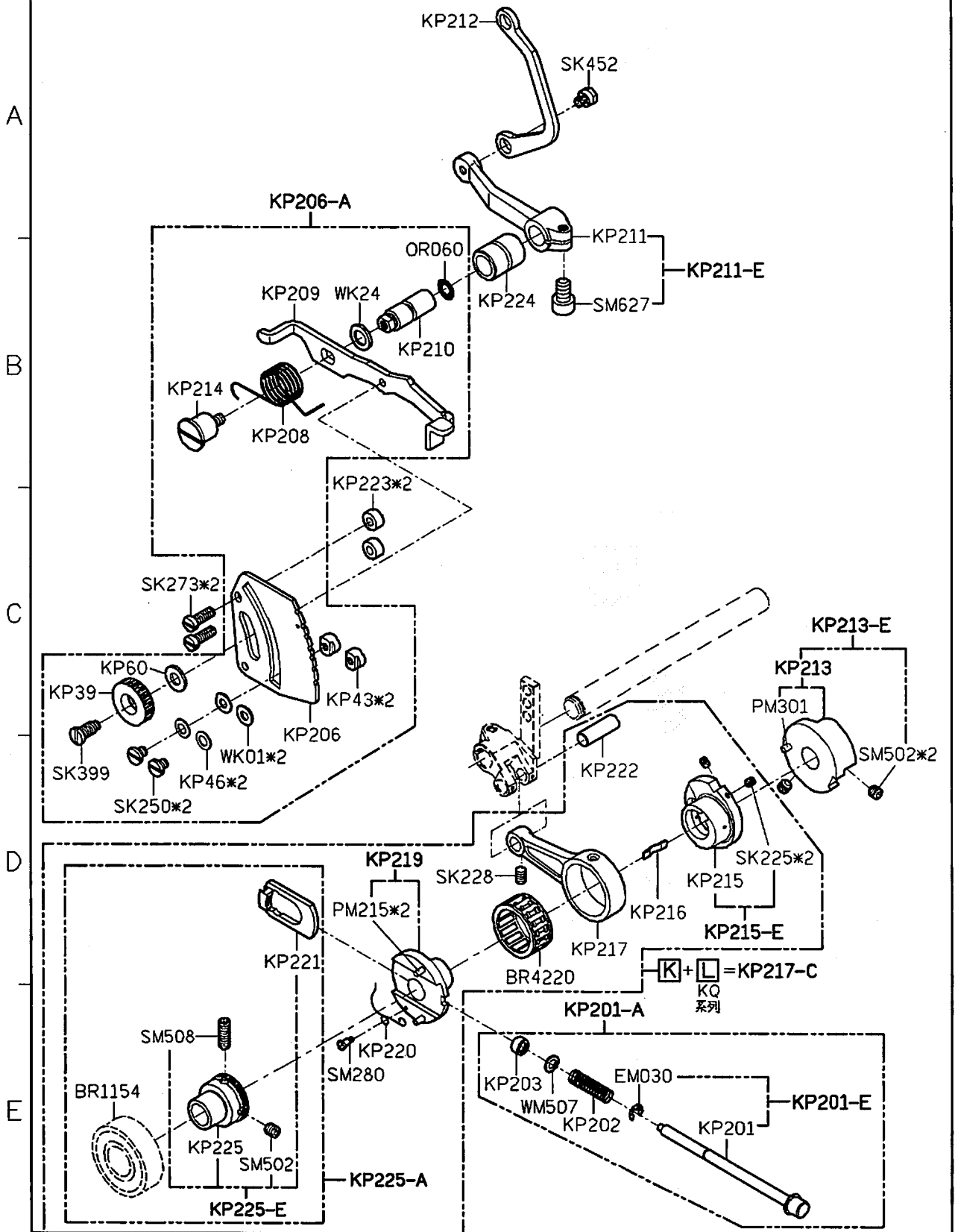

FOR 700K/700KD/988/988D

10/07/23

700K PARTS LIST FOR KQ GROUP P.1/1

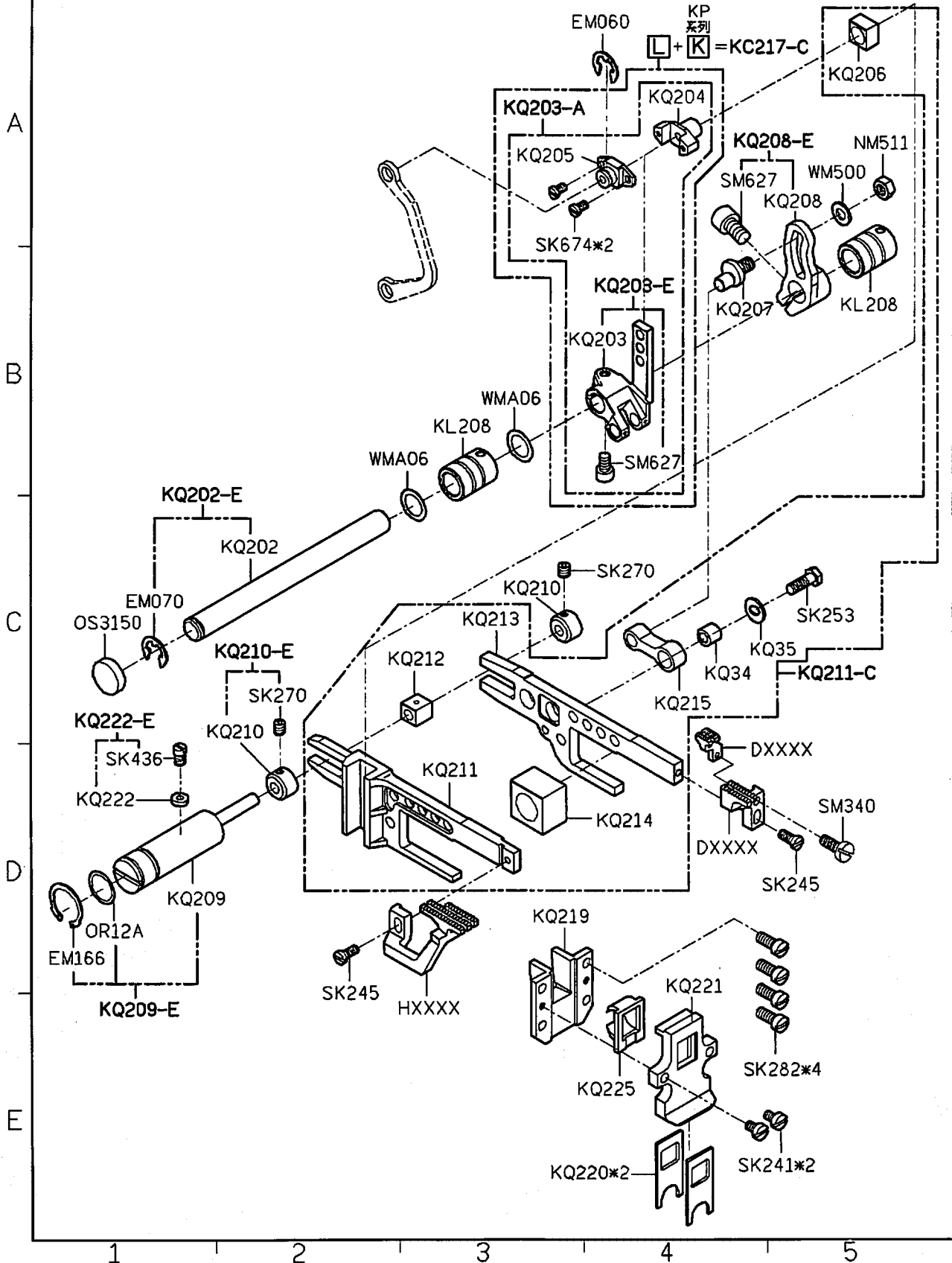

700K PARTS LIST FOR KR GROUP P.1/1

MODEL	3線/4線	5線/6線
PARTS NO	KR202	KR218
	KR202-E	KR218-E
	KR206	KR221
	KR206-A	KR221-A
	KR209	KR219
	KR209-A	KR219-A

A

B

C

D

E

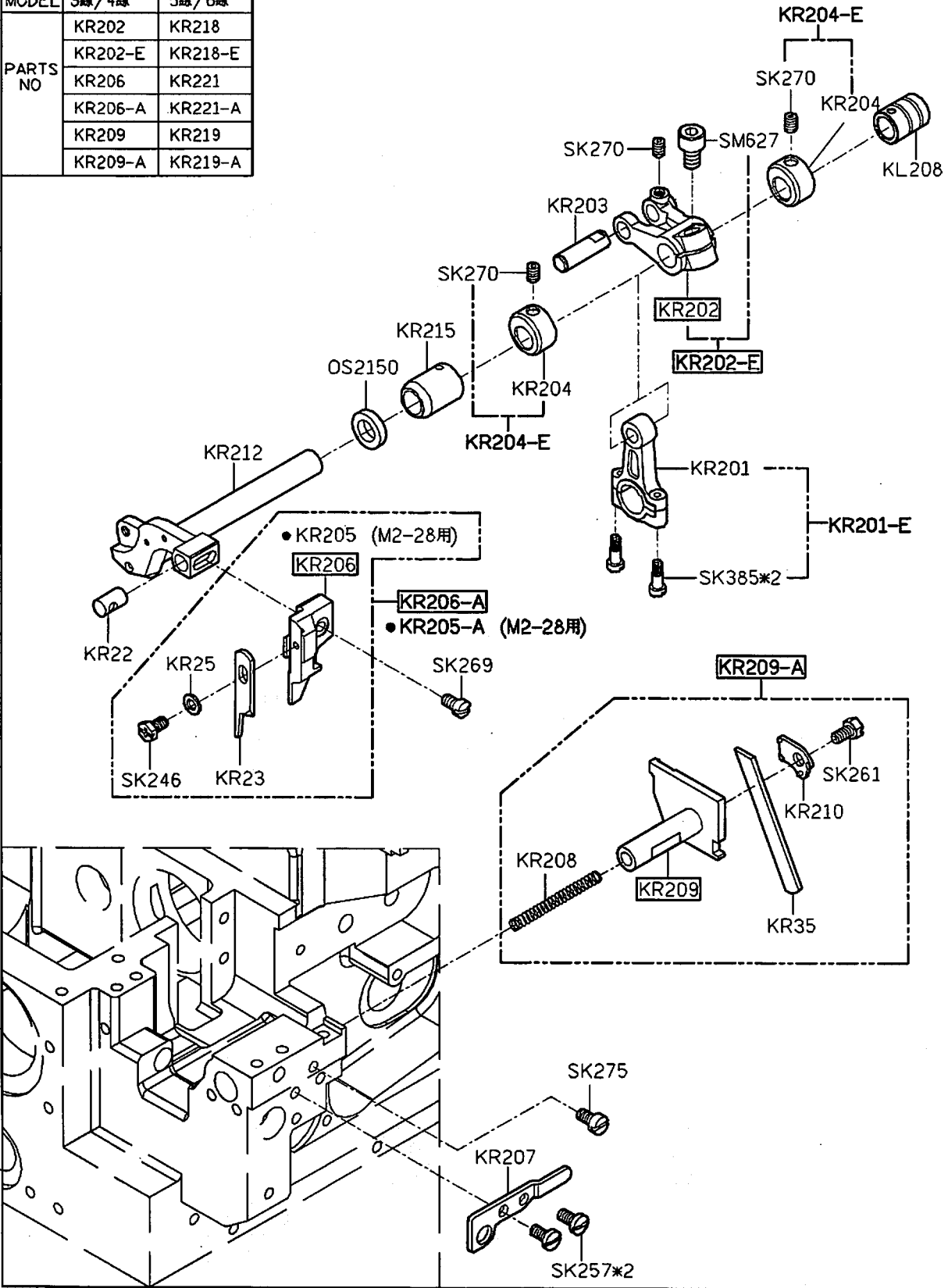

700K PARTS LIST FOR KS GROUP P.1/1

FOR 700K/988

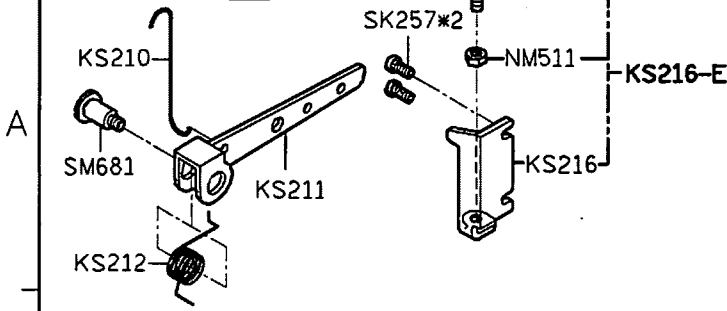

FOR 700KD/988D

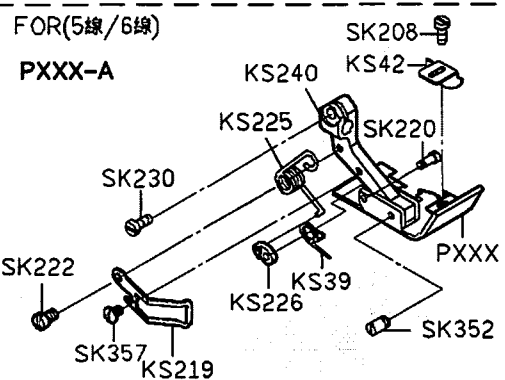
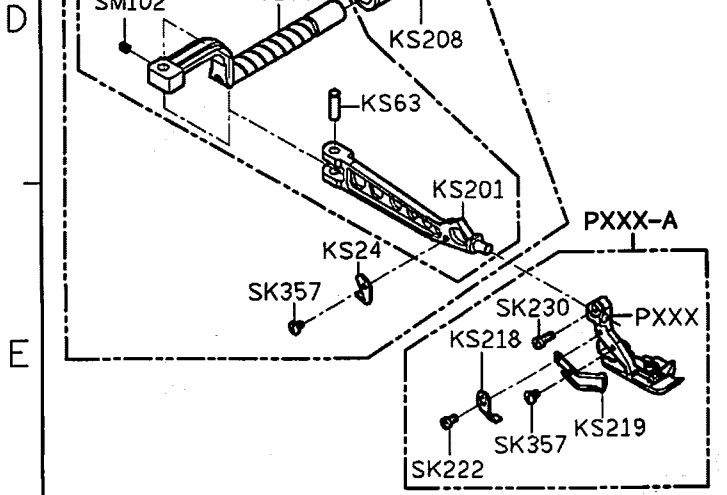
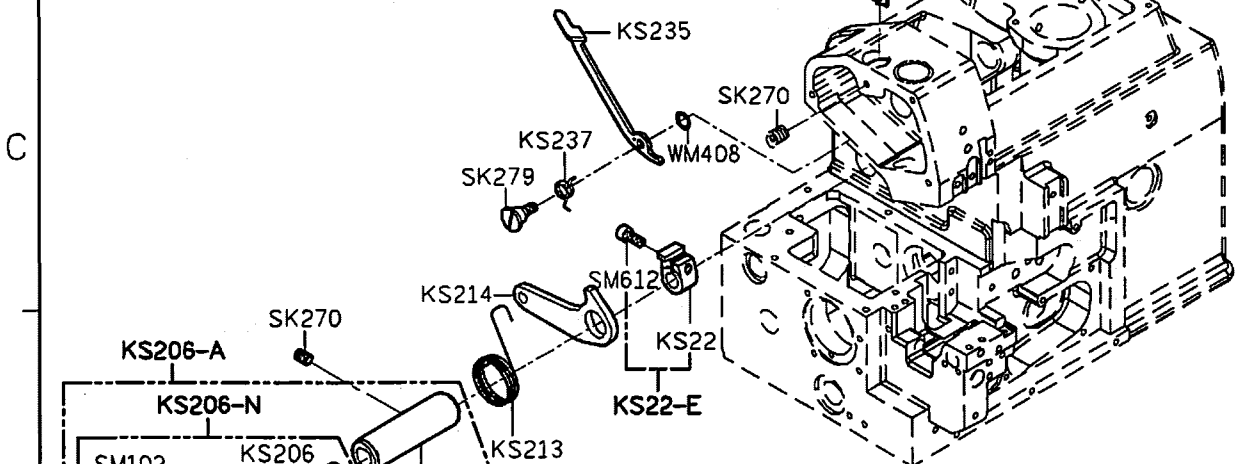
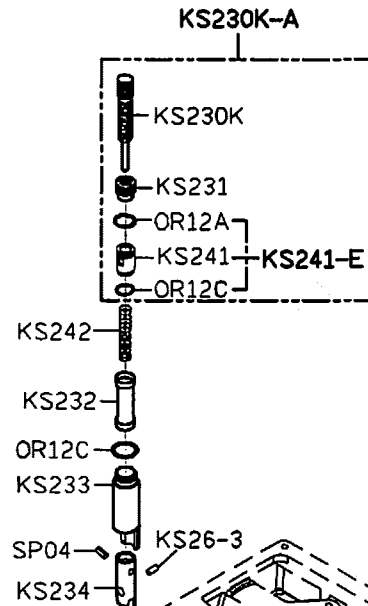
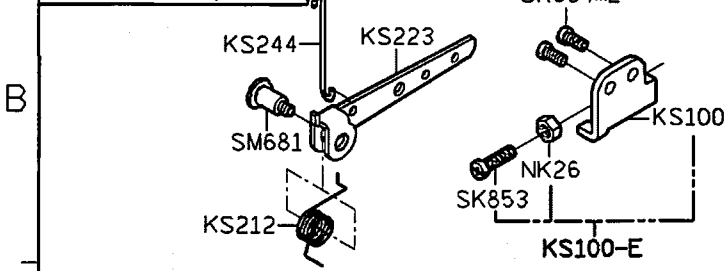

700K PARTS LIST FOR KT GROUP P.1/1

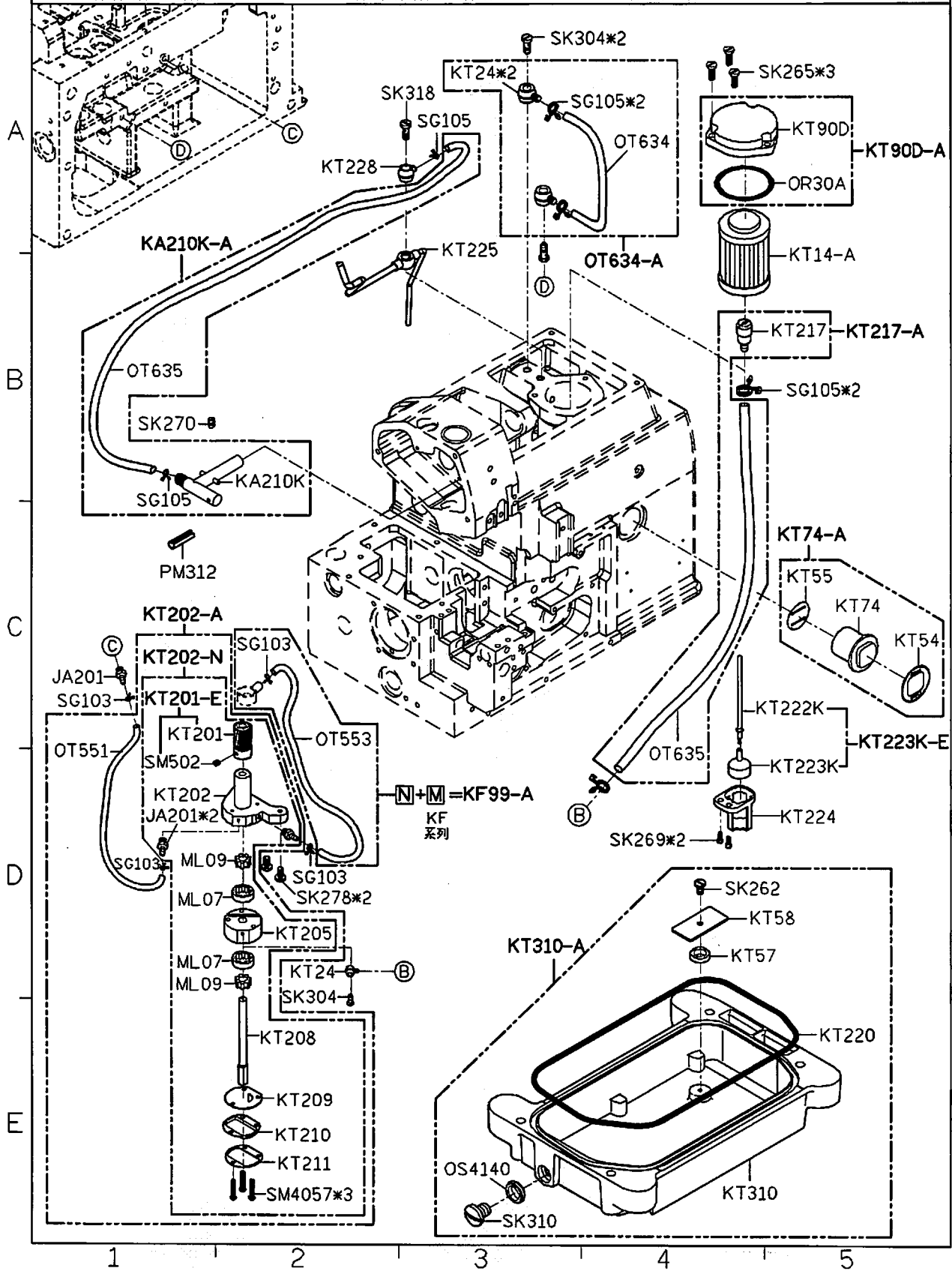

FOR 700K/700KD/988/988D

11/04/25

700K PARTS LIST FOR KU GROUP P.1/1

MODEL	3線/4線	5線/6線
PARTS NO	KU40	KU39
	KU220-4	KU220-5
	KU207	KU209
	KU206	KU211
	KU201-4	KU201-5
	SK277	SK437

A

B

C

D

E

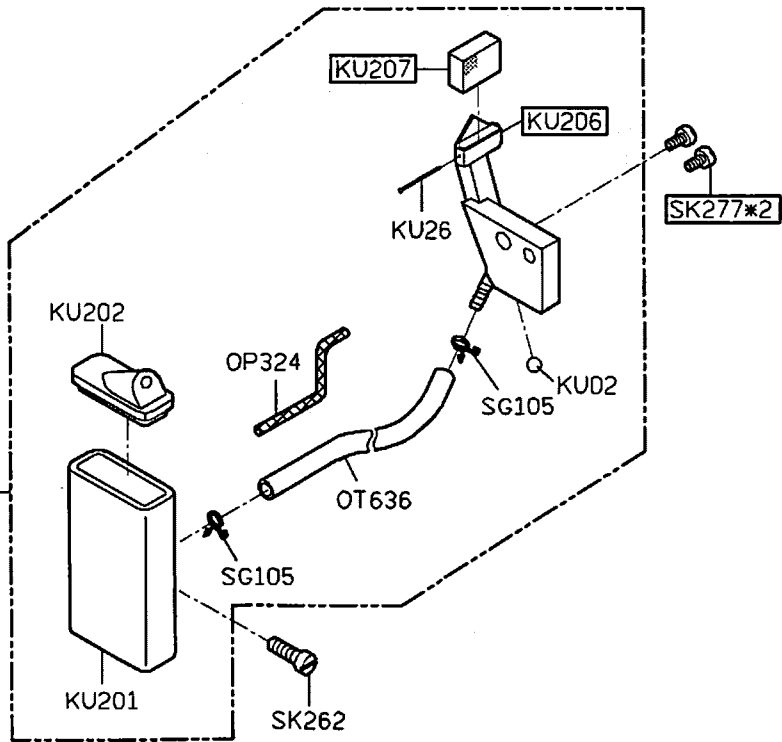
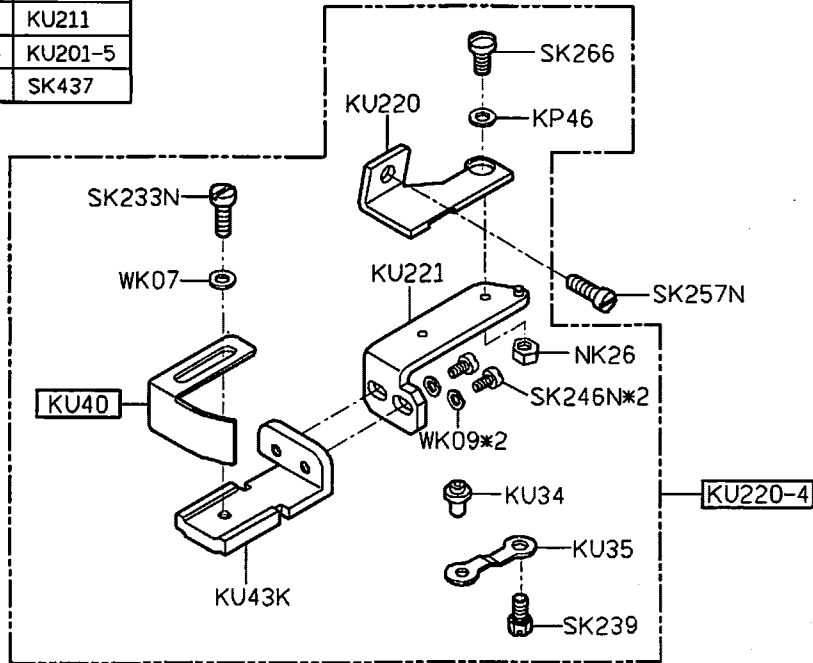

700K PARTS LIST FOR KW GROUP P.1/4

KW40E-3

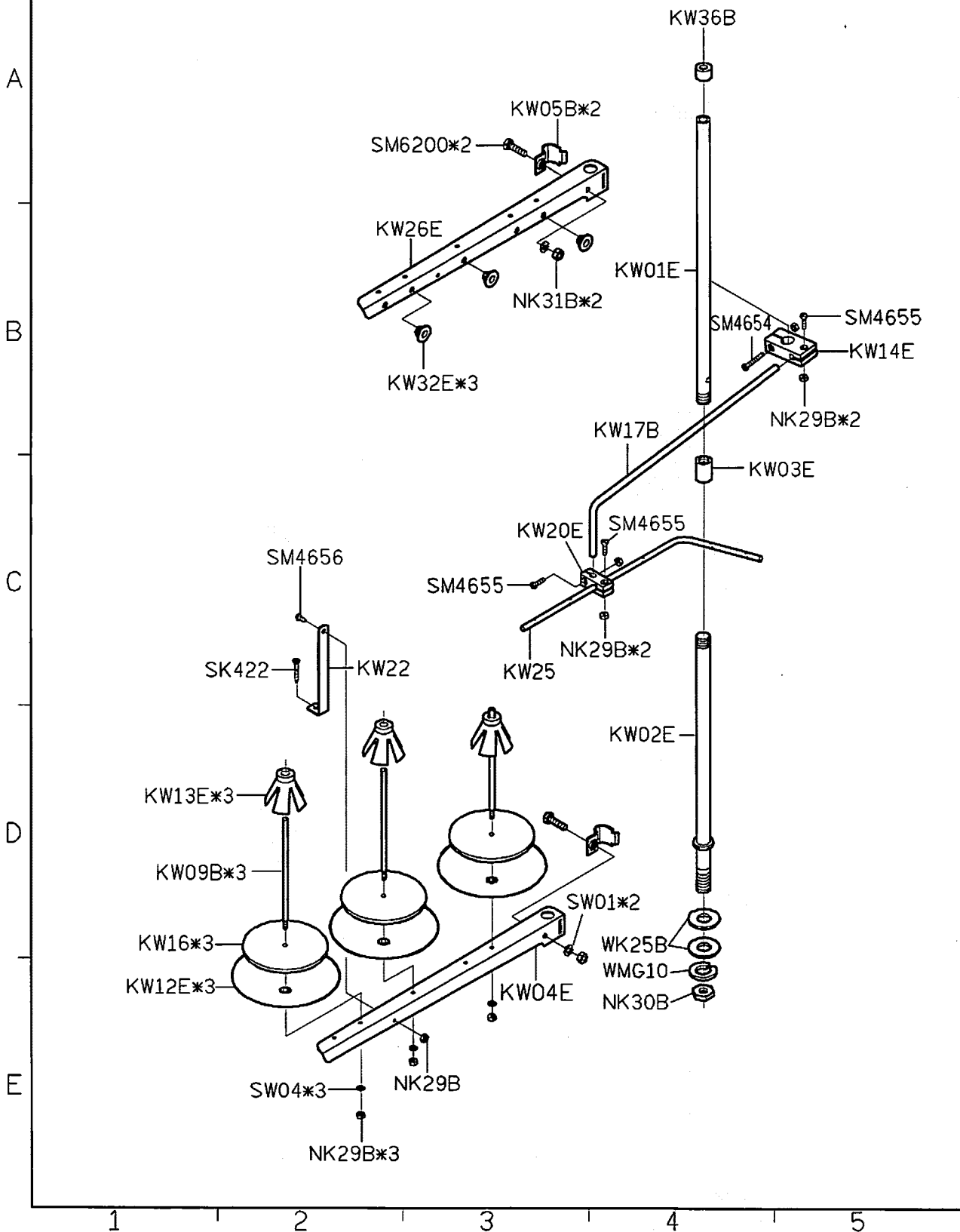

700K PARTS LIST FOR KW GROUP P.2/4

KW40E-4

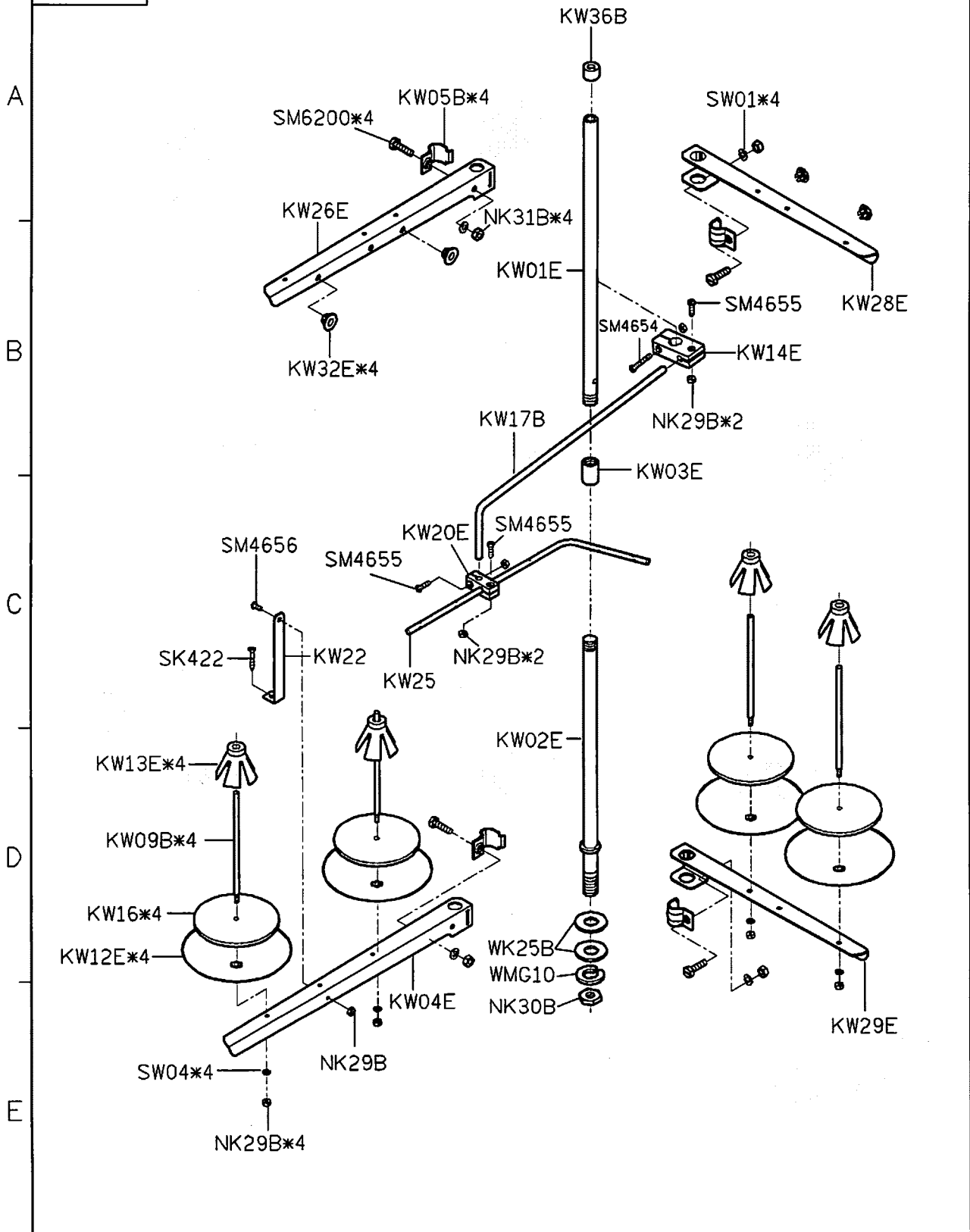

FOR 700K/700KD/988/988D

11/03/12

700K PARTS LIST FOR KW GROUP P.3/4

KW40E-5

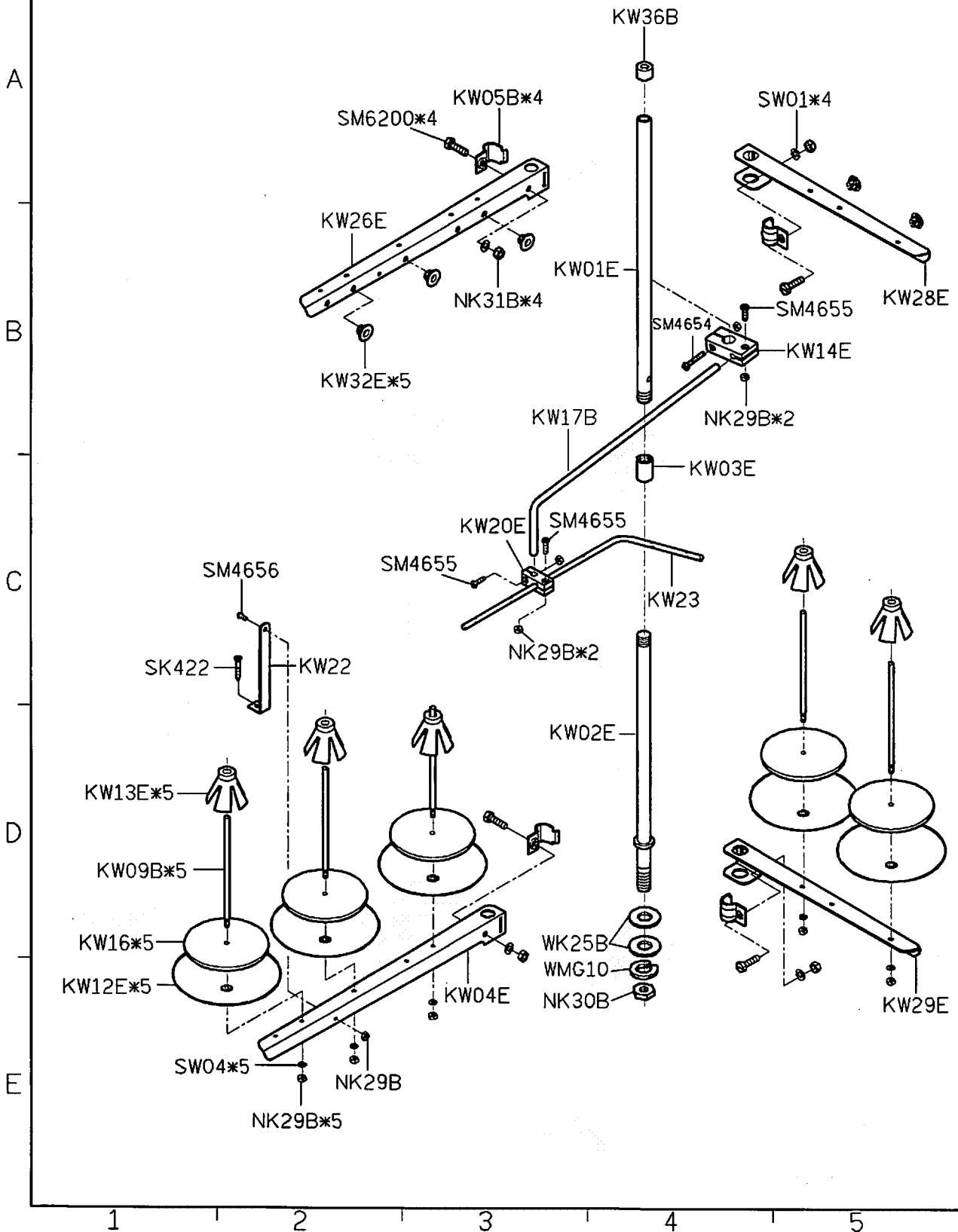

700K PARTS LIST FOR KW GROUP P.4/4



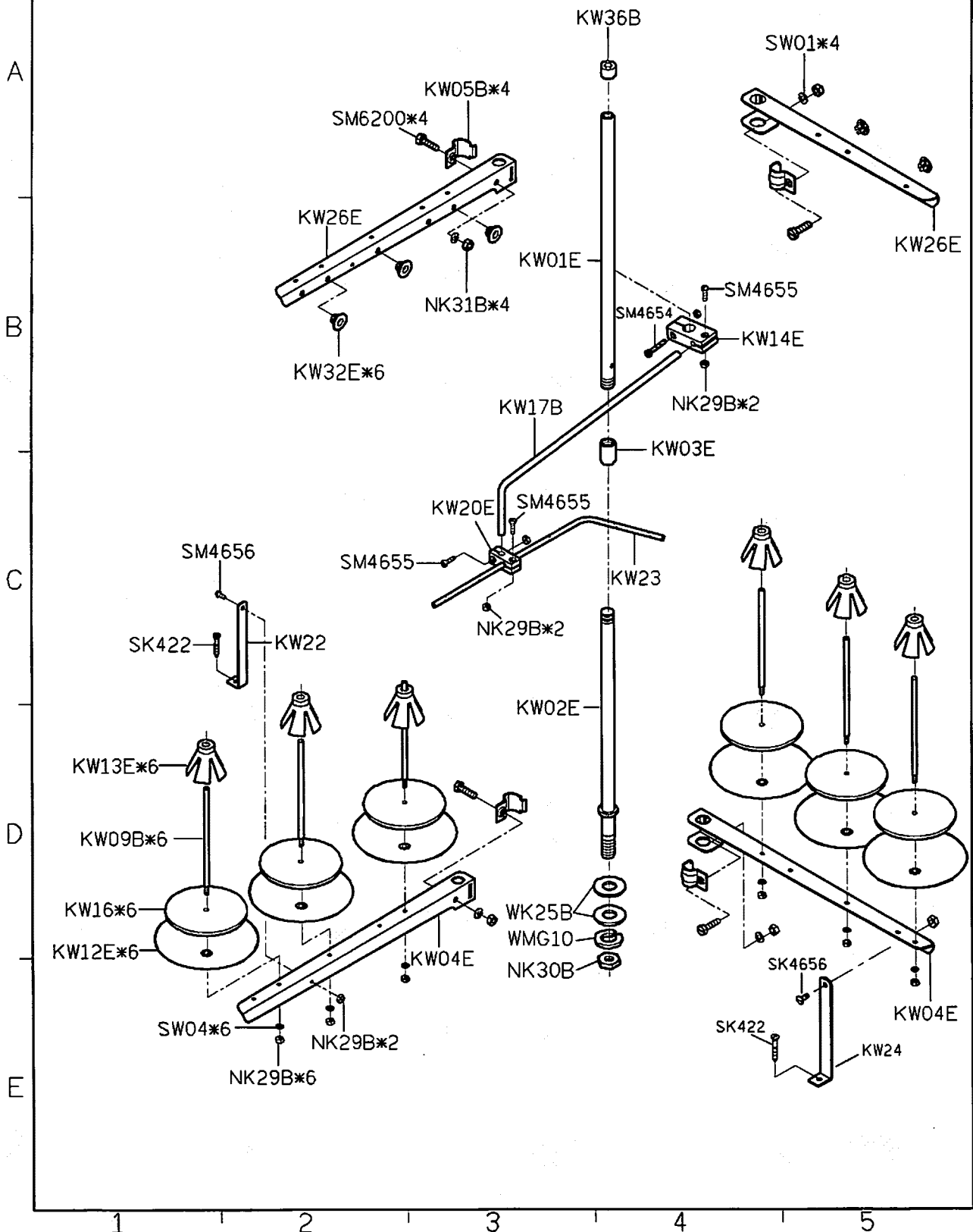



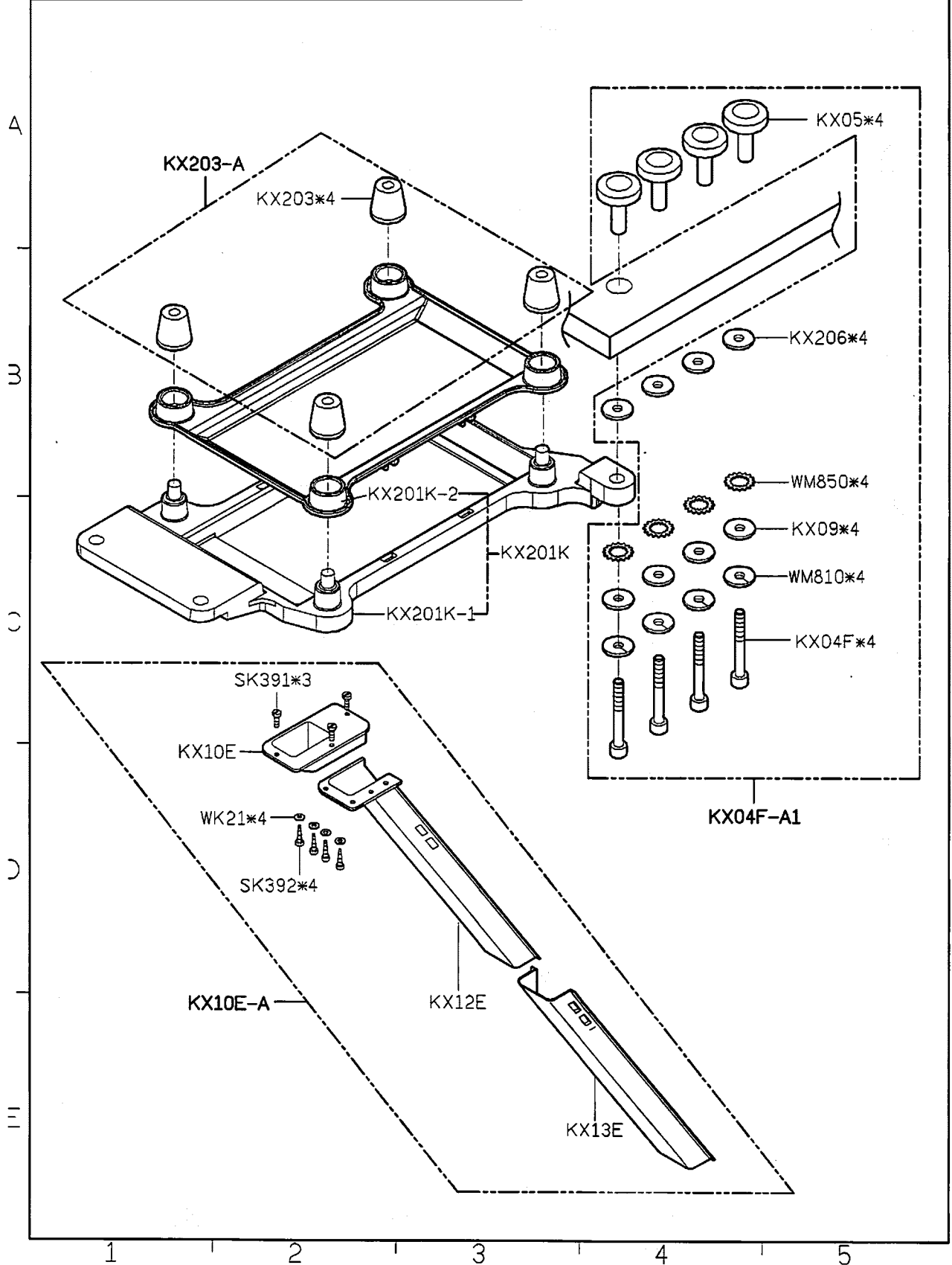



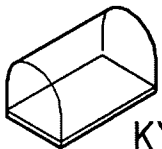
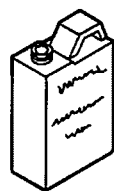



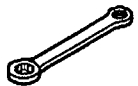
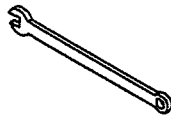



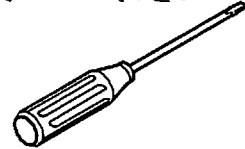
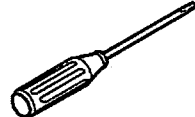

KW40E-6

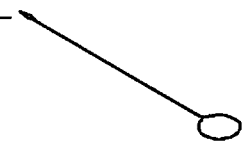
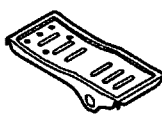

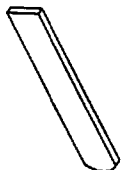
700K PARTS LIST FOR KX GROUP P.1/1

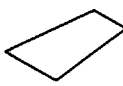

700K PARTS LIST FOR KY GROUP P.1/1

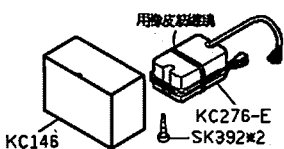
	KY01-1 防塵罩	KY02F-A 油罐	KY03 油壺	KY04 漏斗	KY05-A 油壺
A					
	KY23-A			KY10-A	
B	KY23 內六角扳手	KY09 開口扳手	KY10 六角扳手	KY11 六角扳手	KY12 六角扳手
					
			KY16-A		
	SK216 螺絲	KY14 內六角螺絲起子	KY16 一字起子	KY17 一字起子	KY18 鑷子
					
C	KY19 穿線器	KY20D 腳踏板	KY21-A/MY21-A 鉤子/鍊條		KY201 工具袋
					
D	KR35 下刀片	KT14-A 濾油器	KY30 針板紙	KZ03 乾燥濟	針*5 車針
					
E	KZ08J 使用說明書	KZ08J-2 零件圖	*KC276-A 燈座電器組		
					
			KC146	KC276-E	SK392*2

700K PARTS LIST FOR KZ GROUP P.1/1

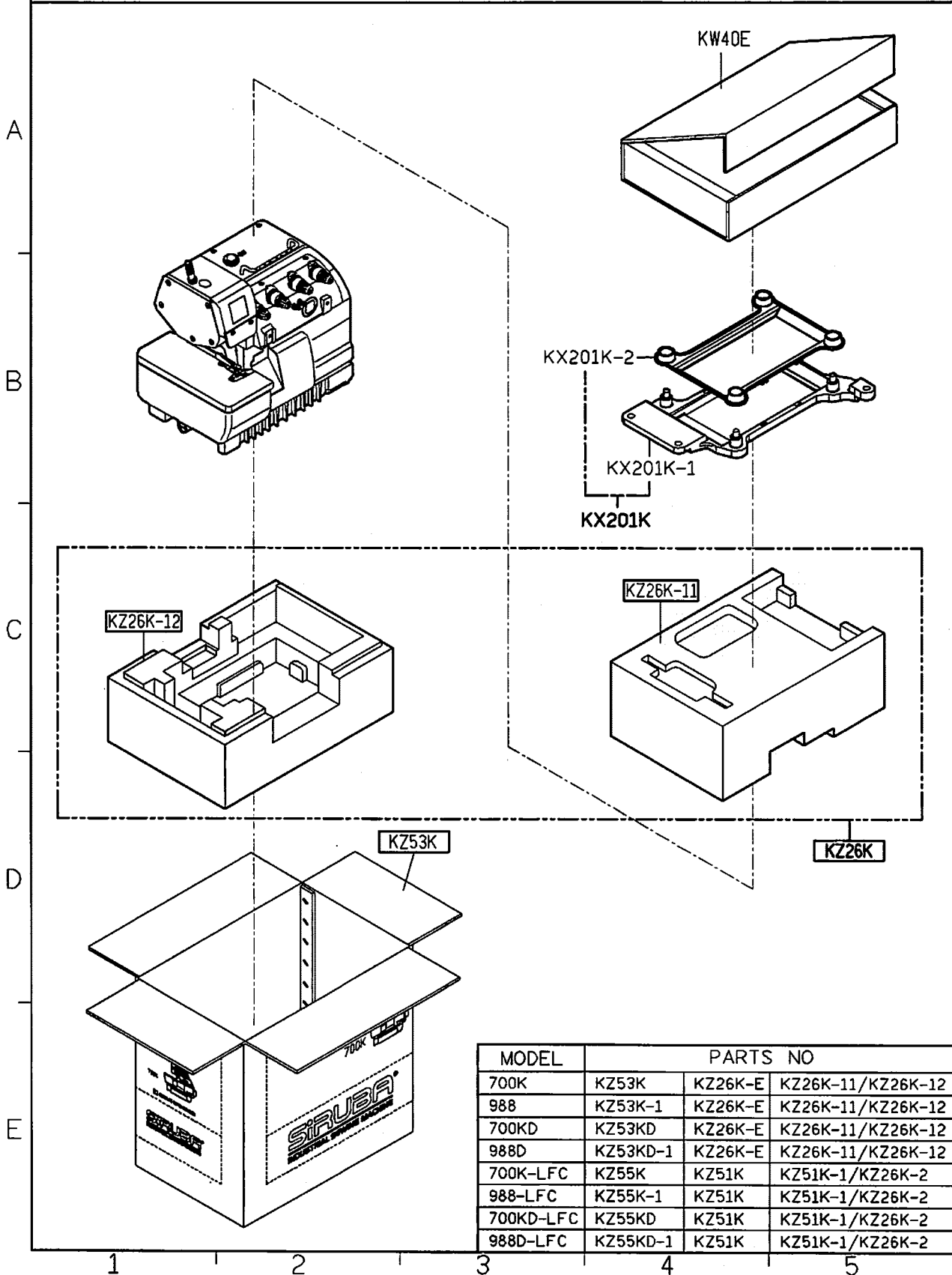

MODEL	PARTS NO		
700K	KZ53K	KZ26K-E	KZ26K-11/KZ26K-12
988	KZ53K-1	KZ26K-E	KZ26K-11/KZ26K-12
700KD	KZ53KD	KZ26K-E	KZ26K-11/KZ26K-12
988D	KZ53KD-1	KZ26K-E	KZ26K-11/KZ26K-12
700K-LFC	KZ55K	KZ51K	KZ51K-1/KZ26K-2
988-LFC	KZ55K-1	KZ51K	KZ51K-1/KZ26K-2
700KD-LFC	KZ55KD	KZ51K	KZ51K-1/KZ26K-2
988D-LFC	KZ55KD-1	KZ51K	KZ51K-1/KZ26K-2

From the library of: Superior Sewing Machine & Supply LLC

TABLE CUT-OUT OF 700K-T

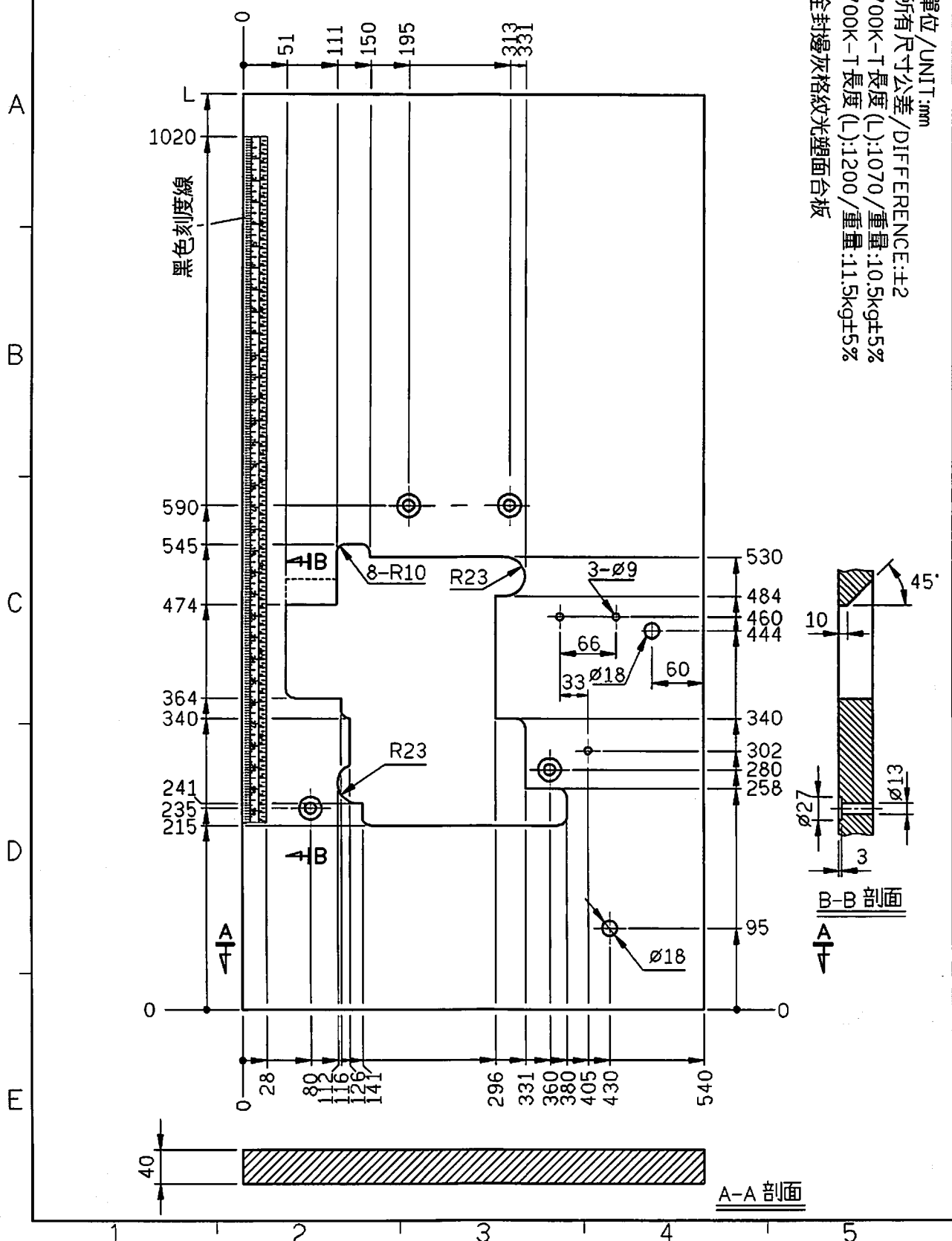

單位/UNIT:mm
 所有尺寸公差/DIFFERENCE:±2
 700K-T長度(L):1070/重量:10.5kg±5%
 700K-T長度(L):1200/重量:11.5kg±5%
 全封邊灰格紋光塑面台板

TABLE CUT-OUT OF 700K-T1

單位/UNIT:mm
 所有尺寸公差/DIFFERENCE:±2
 700K-T1 重量:12.4kg±5%
 全封邊灰格紋光面面板

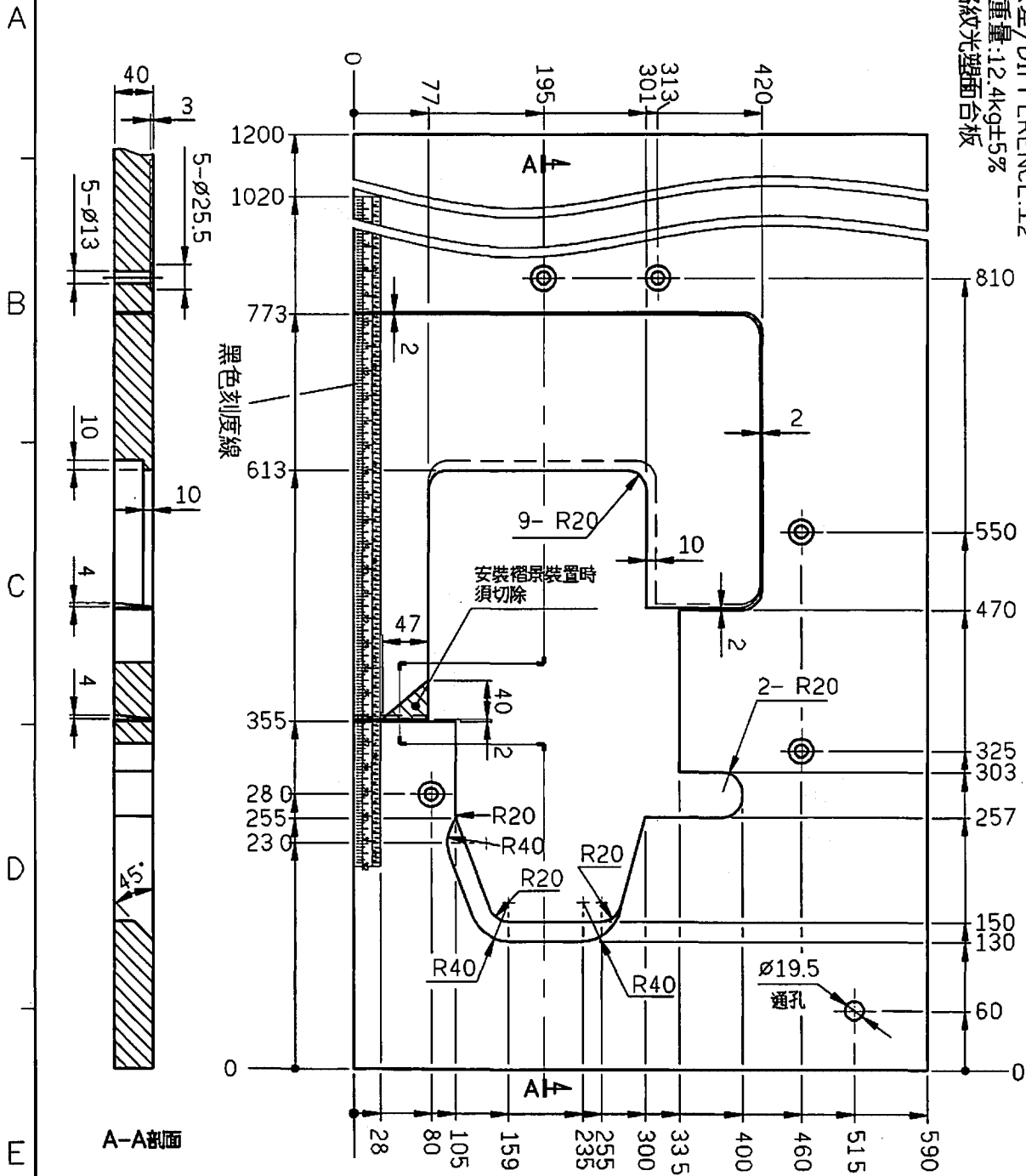

*全沉式桌板

10/09/13

TABLE CUT-OUT OF 700K-T2

單位/UNIT:mm
 FOR 700K/988
 所有尺寸公差/DIFFERENCE:±2
 700K-T2 重量:12.4kg±5%
 全封邊灰格紋光塑面台板

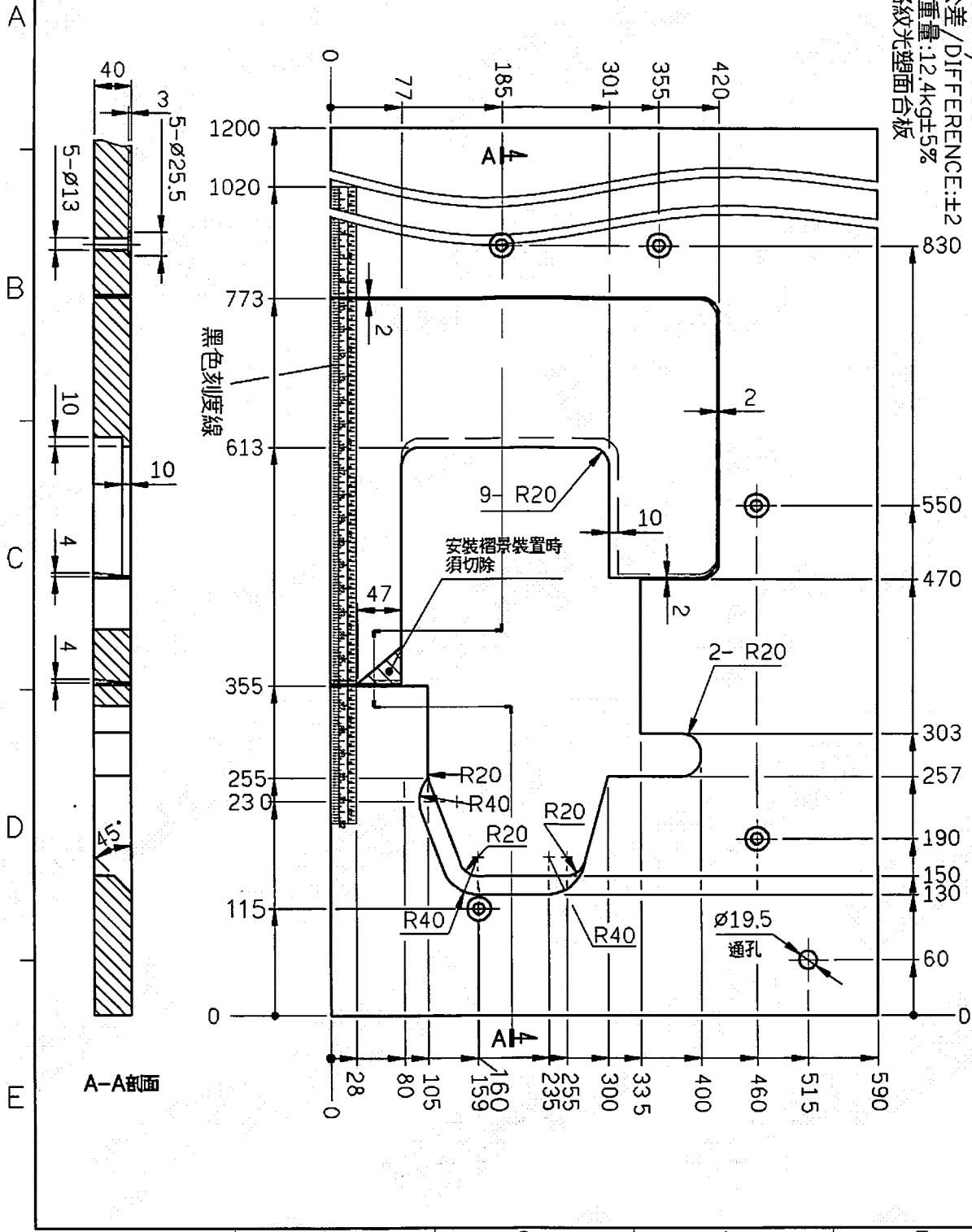

*下沉式桌板

10/09/13

TABLE CUT-OUT OF 700K-T3

單位/UNIT:mm
 FOR 700K/988
 所有尺寸公差/DIFFERENCE:±2
 700K-T3 重量:12.4kg±5%
 全封邊灰格紋光塑面板

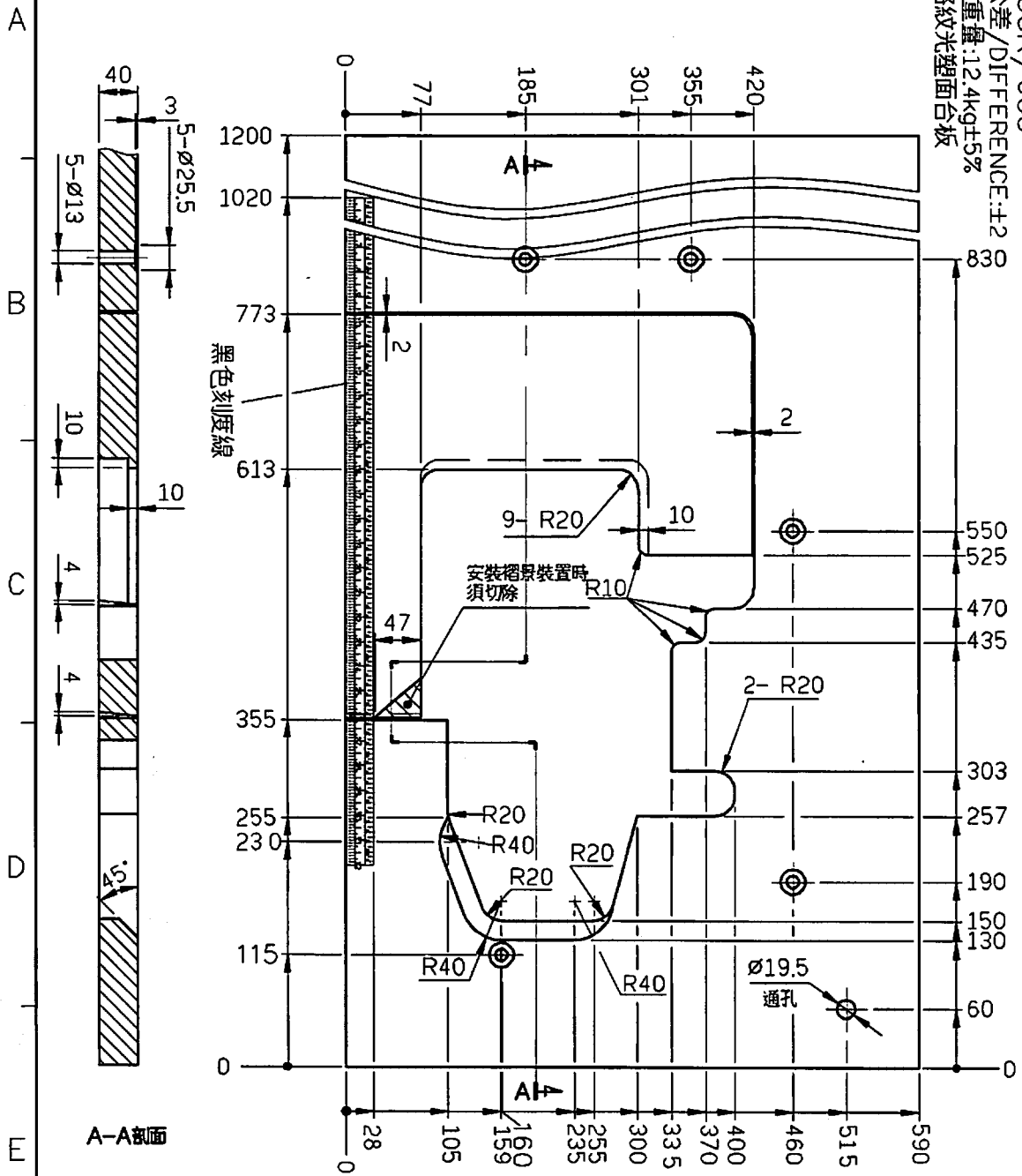

*下沉式桌板

11/03/10

TABLE CUT-OUT OF 700KD-T

單位 /UNIT:mm
 所有尺寸公差 /DIFFERENCE:±2
 700KD-T長度(L):1070 /重量:10.3kg±5%
 700KD-T長度(L):1200 /重量:11.3kg±5%
 除標示尺寸外,其餘尺寸同700K-T
 全封邊灰格紋光塑面台板

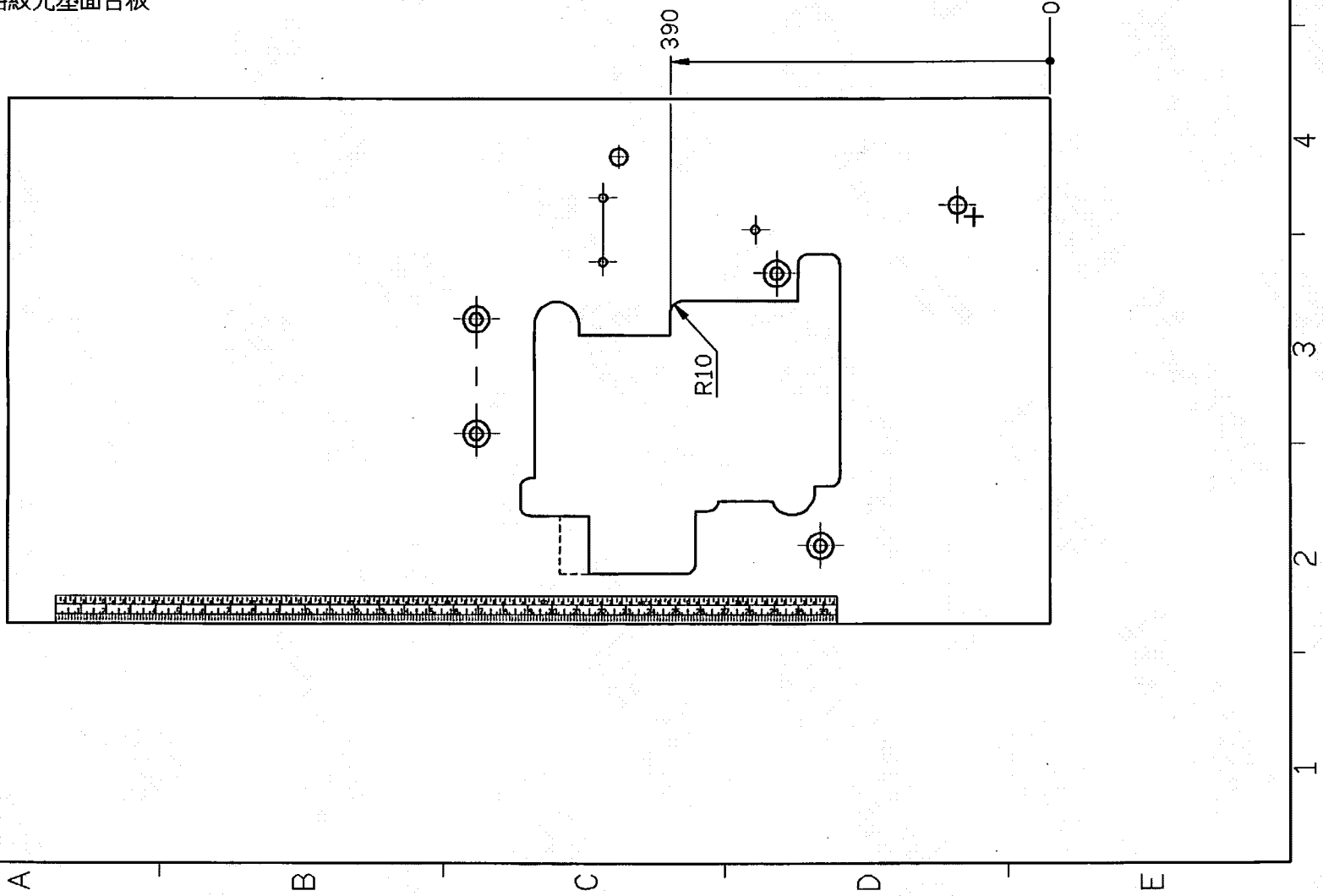
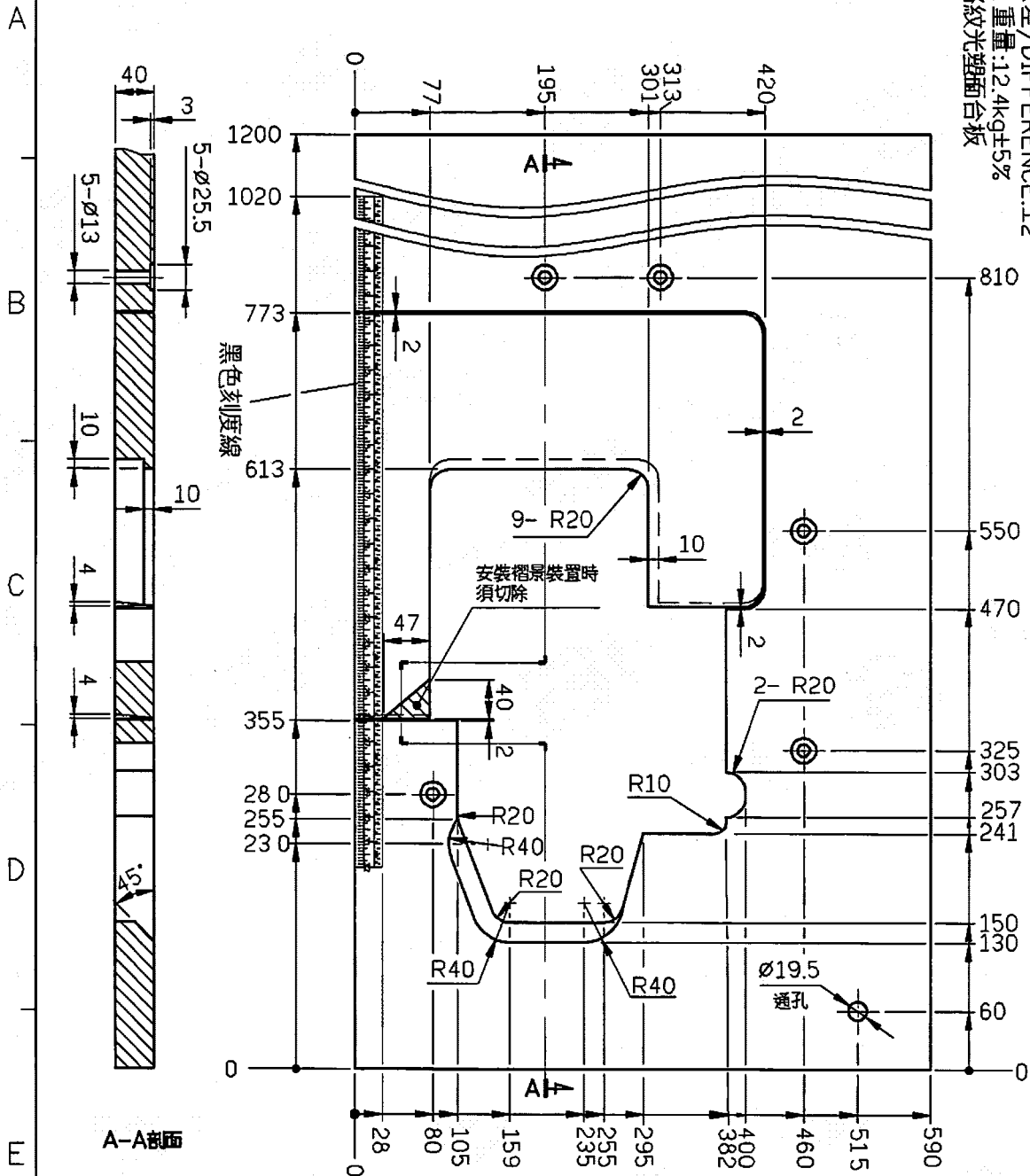

TABLE CUT-OUT OF 700KD-T1

單位/UNIT:mm
 所有尺寸公差/DIFFERENCE:±2
 700KD-T1 重量:12.4kg±5%
 全封邊灰格紋光塑面台板



*全沉式桌板

11/03/10

TABLE CUT-OUT OF 700KD-T3

單位/UNIT:mm
 FOR 700K/988
 所有尺寸公差/DIFFERENCE:±2
 700KD-T3 重量:12.4kg±5%
 全封邊灰格紋光塑面台板

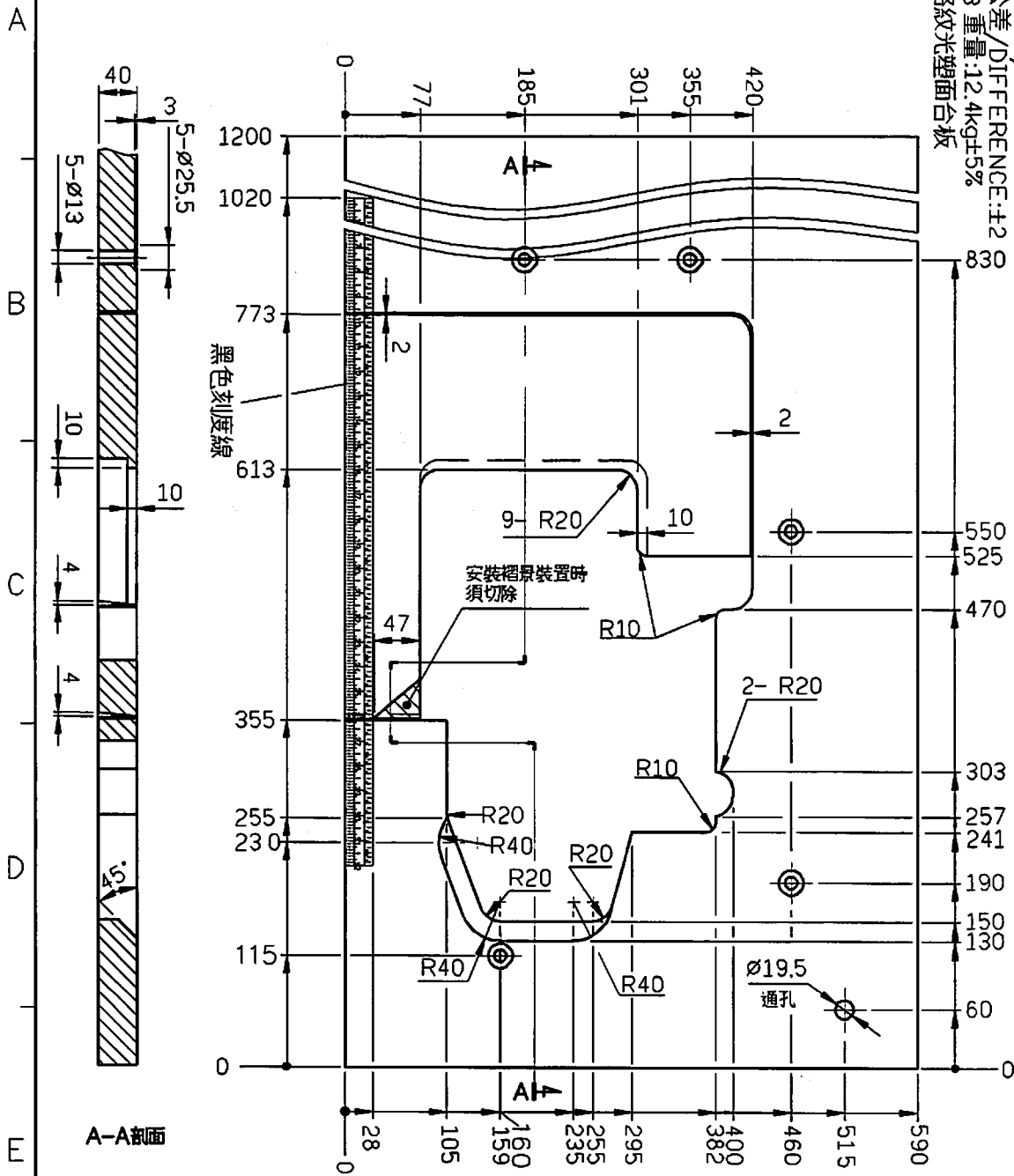

*下沉式桌板

11/03/10