

SIRUBA®

銀箭牌工業用縫紉機

INDUSTRIAL SEWING MACHINE

700HD

零件圖 PARTS LIST







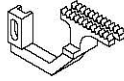
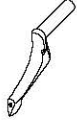

CE



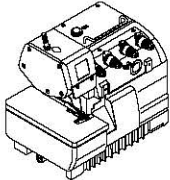
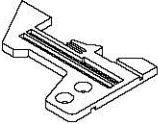
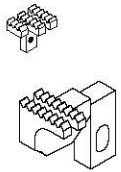
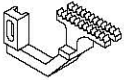
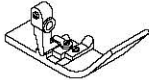

 高林股份有限公司
KAULIN MFG. CO., LTD.

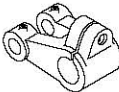
From the library of: Superior Sewing Machine & Supply LLC

											
機 型 MODEL	針板 NEEDLE PLATE	送 具 FEED DOG		送 具 FEED DOG	押 具 PRESSER FOOT	勾 針 LOOPER	針座 NEEDLE CLAMP	束 子 COLLAR	衝 程 CRANK	衝 程 CRANK	針 號 NEEDLE
737HD-504M1-15	E934D	D438	D912	H442	P152D-2	LP26	KG231-E	KJ10F	KF87-A	KJ09B-E	DC27 #9
737HD-504M2-04	E800	D440	D095	H445	P253E-3	LP26	KG231-E	KJ10F	KF87-A	KJ09B-E	DC27 #11
737HD-504M2-04CT	E800C	D440	D095	H445	P253E-3	LP26	KG231-E	KJ10F	KF87-A	KJ09B-E	DC27 #11
737HD-504M2-04TR	E011	D015	D011	H445	P101-3	LP26	KG231-E	KJ10F	KF87-A	KJ09B-E	DC27 #11
737HD-504M2-04VT	E800	D440	D095	H445	P253E-3	LP26	KG231-E	KJ10F	KF87-A	KJ09B-E	DC27 #11
737HD-504M3-05PZ	E797	D440	D674	H445	PZ01-A	LP26	KG231-E	KJ10F	KF87-A	KJ09B-E	DC27 #18
737HD-504M3-05	E797	D440	D674	H445	P230-3	LP26	KG231-E	KJ10F	KF87-A	KJ09B-E	DC27 #11
737HD-504M3-05CT	E797C	D440	D674	H445	P230-3	LP26	KG231-E	KJ10F	KF87-A	KJ09B-E	DC27 #11
737HD-504M3-05VT	E797	D440	D674	H445	P230-3	LP26	KG231-E	KJ10F	KF87-A	KJ09B-E	DC27 #11
737HD-504M5-04BK	E589F	D969	D675	H974	P975-3	LP26	KG231-E	KJ10F	KF87-A	KJ09B-E	DC27 #11
737HD-504M5-04BK/VT	E589F	D969	D675	H974	P975-3	LP26	KG231-E	KJ10F	KF87-A	KJ09B-E	DC27 #11
737HD-505F1-04	E784	D438	D674	H442	P152D-3	LP26	KG231-E	KJ10F	KF87-A	KJ09B-E	DC27 #9
737HD-505F1-04ES	E784	D438	D674	H442	P152D-3	LP26	KG231-E	KJ10F	KF87-A	KJ09B-E	DC27 #9
737HD-505F1-04VT	E784	D438	D674	H442	P152D-3	LP26	KG231-E	KJ10F	KF87-A	KJ09B-E	DC27 #9
737HD-504M3-04	E796	D440	D674	H445	P230-3	LP26	KG231-E	KJ10F	KF87-A	KJ09B-E	DC27 #11
737HD-505F1-04ES/VT	E784	D438	D674	H442	P152D-3	LP26	KG231-E	KJ10F	KF87-A	KJ09B-E	DC27 #9
737HD-504M2-04EC	E800C	D440	D095	H445	P253E-3	LP26	KG231-E	KJ10F	KF87-A	KJ09B-E	DC27 #11
737HD-504M1-15VT	E934D	D438	D912	H442	P152D-5	LP26	KG231-E	KJ10F	KF87-A	KJ09B-E	DC27 #9
737HD-504M2-04TR/EC	E011C	D011	D015	H445	P101-3	LP26	KG231-E	KJ10F	KF87-A	KJ09B-E	DC27 #11
737HD-504F1-04	E784	D438	D674	H442	P152D-3	LP26	KG231-E	KJ10F	KF87-A	KJ09B-E	DC27 #9
747HD-512M1-25	E920	D440	D095	H445	P253E-4	LP36	KG242-E	KJ13F	KF86-A	KJ11B-E	DC27 #11*2
747HD-512M1-25CT	E920C	D440	D095	H445	P253E-4	LP36	KG242-E	KJ13F	KF86-A	KJ11B-E	DC27 #11*2
747HD-514H4-24GA	E919	D958	D095	H959	P136-A	LP26	KG242-E	KJ13F	KF86-A	KJ11B-E	DC27 #11*2

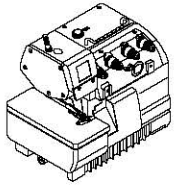
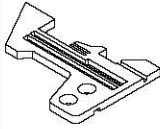
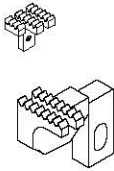
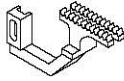
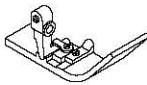
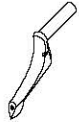
規格件表 CONVERSION CHART-2/4

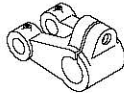
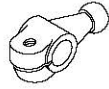
											
機 型 MODEL	針板 NEEDLE PLATE	送 具 FEED DOG		送 具 FEED DOG	押 具 PRESSER FOOT	勾 針 LOOPER	針座 NEEDLE CLAMP	束 子 COLLAR	衝 程 CRANK	衝 程 CRANK	針 號 NEEDLE
747HD-514H4-24GA/CT	E919C	D958	D095	H959	P136-A	LP26	KG242-E	KJ13F	KF86-A	KJ11B-E	DC27 #11*2
747HD-514H4-24GA/EC	E919C	D958	D095	H959	P136-A	LP26	KG242-E	KJ13F	KF86-A	KJ11B-E	DC27 #11*2
747HD-514H4-24GA/P	E919	D958	D095	H959	P136P-A	LP26	KG242-E	KJ13F	KF86-A	KJ11B-E	DC27 #11*2
747HD-514M2-24	E919	D440	D095	H445	P253E-4	LP26	KG242-E	KJ13F	KF86-A	KJ11B-E	DC27 #11*2
747HD-514M2-24CT	E919C	D440	D095	H445	P253E-4	LP26	KG242-E	KJ13F	KF86-A	KJ11B-E	DC27 #11*2
747HD-514M2-24EC	E919C	D440	D095	H445	P253E-4	LP26	KG242-E	KJ13F	KF86-A	KJ11B-E	DC27 #11*2
747HD-514M2-24TG	E919	D440	D095	H445	P254G-4	LP26	KG242-E	KJ13F	KF86-A	KJ11B-E	DC27 #11*2
747HD-514M2-24TG/EC	E919C	D440	D095	H445	P254G-4	LP26	KG242-E	KJ13F	KF86-A	KJ11B-E	DC27 #11*2
747HD-514M2-24VT	E810C	D440	D095	H445	P253E-4	LP26	KG242-E	KJ13F	KF86-A	KJ11B-E	DC27 #11*2
747HD-514M2-25TG	E920	D440	D095	H445	P253G-4	LP26	KG242-E	KJ13F	KF86-A	KJ11B-E	DC27 #11*2
747HD-514M2-25	E920C	D440	D095	H445	P253E-4	LP26	KG242-E	KJ13F	KF86-A	KJ11B-E	DC27 #11*2
747HD-514M2-25CT	E920C	D440	D095	H445	P253E-4	LP26	KG242-E	KJ13F	KF86-A	KJ11B-E	DC27 #11*2
747HD-514M4-23	E804	D440	D674	H445	P230-A	LP26	KG242-E	KJ13F	KF87-A	KJ11B-E	DC27 #11*2
747HD-514M4-23CT	E804C	D440	D674	H445	P230-A	LP26	KG242-E	KJ13F	KF87-A	KJ11B-E	DC27 #11*2
747HD-514M5-23BK	E591B	D969	D657	H974	P975-4	LP26	KG242-E	KJ13F	KF86-A	KJ11B-E	DC27 #11*2
747HD-514M7-23	E804A	D441	D674	H446	P230-A	LP38	KG242-E	KJ13F	KF86-A	KJ11B-E	DC27 #16*2
747HD-514M7-23CT	E804AC	D441	D674	H446	P230-A	LP38	KG242-E	KJ13F	KF86-A	KJ11B-E	DC27 #11*2
747HD-514M7-24	E919A	D441	D095	H446	P253E-4	LP38	KG242-E	KJ13F	KF86-A	KJ11B-E	DC27 #16*2
747HD-514M7-24CT	E919AC	D441	D095	H446	P253E-4	LP38	KG242-E	KJ13F	KF86-A	KJ11B-E	DC27 #16*2
747HD-514M7-25	E920A	D441	D095	H446	P253E-4	LP38	KG242-E	KJ13F	KF86-A	KJ11B-E	DC27 #16*2
747HD-514M7-25CT	E920AC	D441	D095	H446	P253E-4	LP38	KG242-E	KJ13F	KF86-A	KJ11B-E	DC27 #16*2
747HD-514M7-24TG	E919A	D441	D095	H446	P254G-4	LP38	KG242-E	KJ13F	KF86-A	KJ11B-E	DC27 #16*2
747HD-514M7-25TG	E920A	D441	D095	H446	P254G-4	LP38	KG242-E	KJ13F	KF86-A	KJ11B-E	DC27 #16*2

											
機 型 MODEL	針板 NEEDLE PLATE	送 具 FEED DOG		送 具 FEED DOG	押 具 PRESSER FOOT	勾 針 LOOPER	針座 NEEDLE CLAMP	束 子 COLLAR	衝 程 CRANK	衝 程 CRANK	針 號 NEEDLE
747HD-514F1-24	E990	D438	D674	H442	P152D-4	LP26	KG242-E	KJ13F	KF86-A	KJ11B-E	DC27 #11*2
747HD-514M5-23BK/VT	E591B	D675	D969	H974	P975-4	LP26	KG242-E	KJ13F	KF86-A	KJ11B-E	DC27 #11*2
747HD-512M1-34	E832	D440	D095	H447	P253E-A	LP36	KG243-E	KJ13F	KF86-A	KJ11B-E	DC27 #14*2
757HD-401M1/TW	E110			H101	P767-A	LP26	KG253-E		KF86-A		DC27 #14*2
757HD-401M2-50TA	E005	D005	D006	H005	P005-A		TA255-E		KF86-A		DC27 #14*2
757HD-401M2-50TA/EC	E005C	D005	D006	H005	P005-A		TA255-E		KF86-A		DC27 #14*2
757HD-516H4-35GA	E982	D008	D502	H957	P508-A	LP26	KG253-E	KJ10F	KF87-A	KJ09B-E	DC27 #14*2
757HD-516H4-35GA/EC	E982C	D008	D502	H957	P508-A	LP26	KG253-E	KJ10F	KF87-A	KJ09B-E	DC27 #14*2
757HD-516H4-35GA/P	E982	D008	D502	H957	P508P-A	LP26	KG253-E	KJ10F	KF87-A	KJ09B-E	DC27 #14*2
757HD-516H4-35GA/P/EC	E982C	D008	D502	H957	P508P-A	LP26	KG253-E	KJ10F	KF87-A	KJ09B-E	DC27 #14*2
757HD-516H4-55GA	E986	D956	D502	H957	P509-A	LP26	KG255-E	KJ10F	KF87-A	KJ09B-E	DC27 #14*2
757HD-516H4-55GA/EC	E986C	D956	D502	H957	P509-A	LP26	KG255-E	KJ10F	KF87-A	KJ09B-E	DC27 #14*2
757HD-516H4-55GA/P	E986	D956	D502	H957	P509P-A	LP26	KG255-E	KJ10F	KF87-A	KJ09B-E	DC27 #14*2
757HD-516H4-55GA/P/EC	E986C	D956	D502	H957	P509P-A	LP26	KG255-E	KJ10F	KF87-A	KJ09B-E	DC27 #14*2
757HD-516L1-24	E834	D487	D060	H492	P500-A	LP26	KG252-E	KJ10F	KF87-A	KJ09B-E	DC27 #14*2
757HD-516L1-24CT	E834C	D487	D060	H492	P500-A	LP26	KG252-E	KJ10F	KF87-A	KJ09B-E	DC27 #14*2
757HD-516L1-35	E839	D487	D060	H492	P504-A	LP26	KG253-E	KJ10F	KF87-A	KJ09B-E	DC27 #14*2
757HD-516L1-35CT	E839C	D487	D060	H492	P504-A	LP26	KG253-E	KJ10F	KF87-A	KJ09B-E	DC27 #14*2
757HD-516M2-35	E982	D489	D502	H497	P504-A	LP26	KG253-E	KJ10F	KF87-A	KJ11B-E	DC27 #14*2
757HD-516M2-35CT	E982C	D489	D502	H497	P504-A	LP26	KG253-E	KJ10F	KF87-A	KJ11B-E	DC27 #14*2
757HD-516M2-35PS	E982S	D489	D502	H497	P504S-A	LP26	KG253-E	KJ10F	KF87-A	KJ11B-E	DC27 #14*2
757HD-516M2-35PS/EC	E982SC	D489	D502	H497	P504S-A	LP26	KG253-E	KJ10F	KF87-A	KJ11B-E	DC27 #14*2
757HD-516M2-55	E986	D489	D502	H500	P502-A	LP26	KG255-E	KJ10F	KF87-A	KJ11B-E	DC27 #14*2

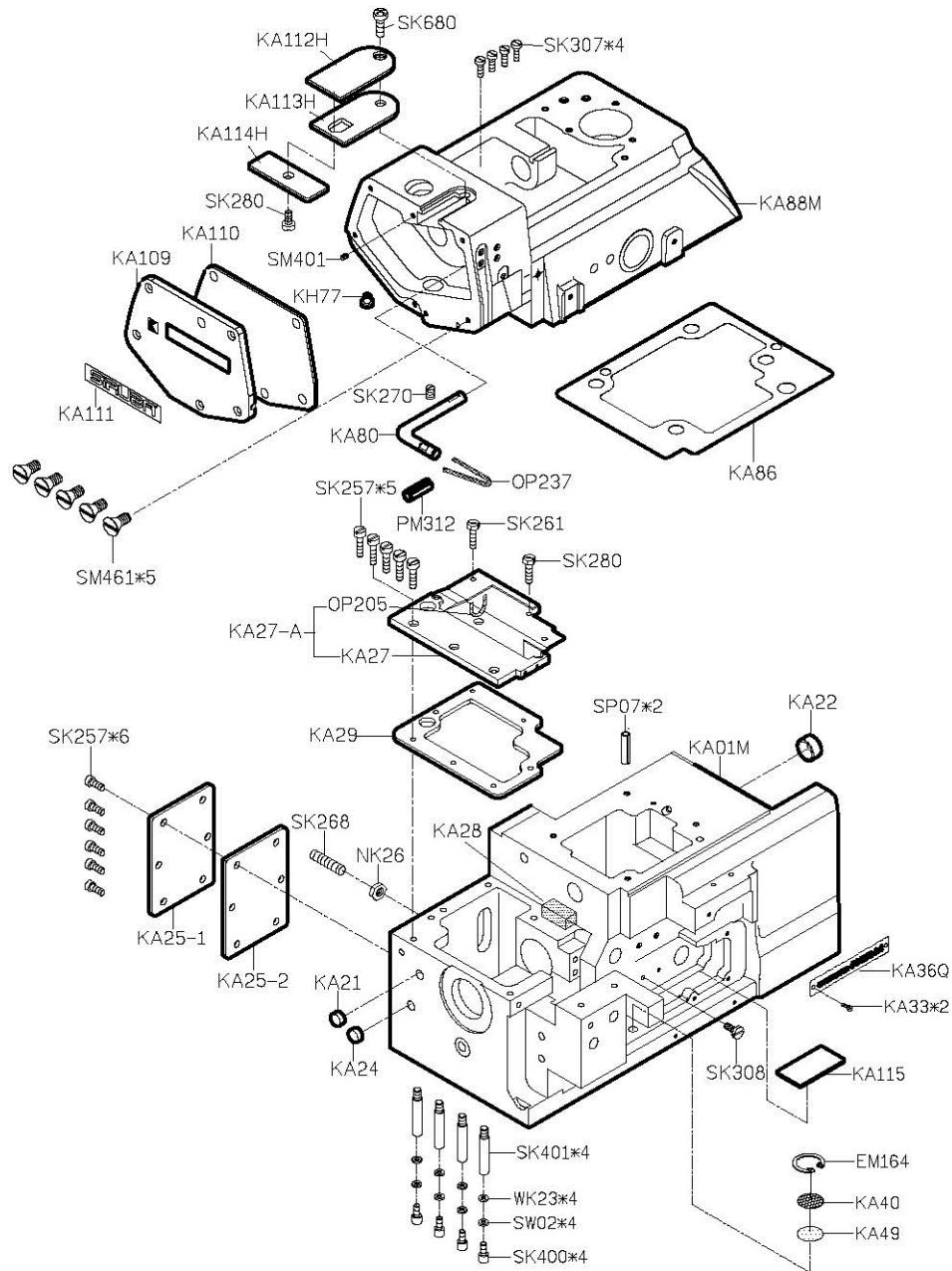

MODEL	三四線車	五六線車
PARTS NO	KB01F	KB02F
	KB22F	KB23F

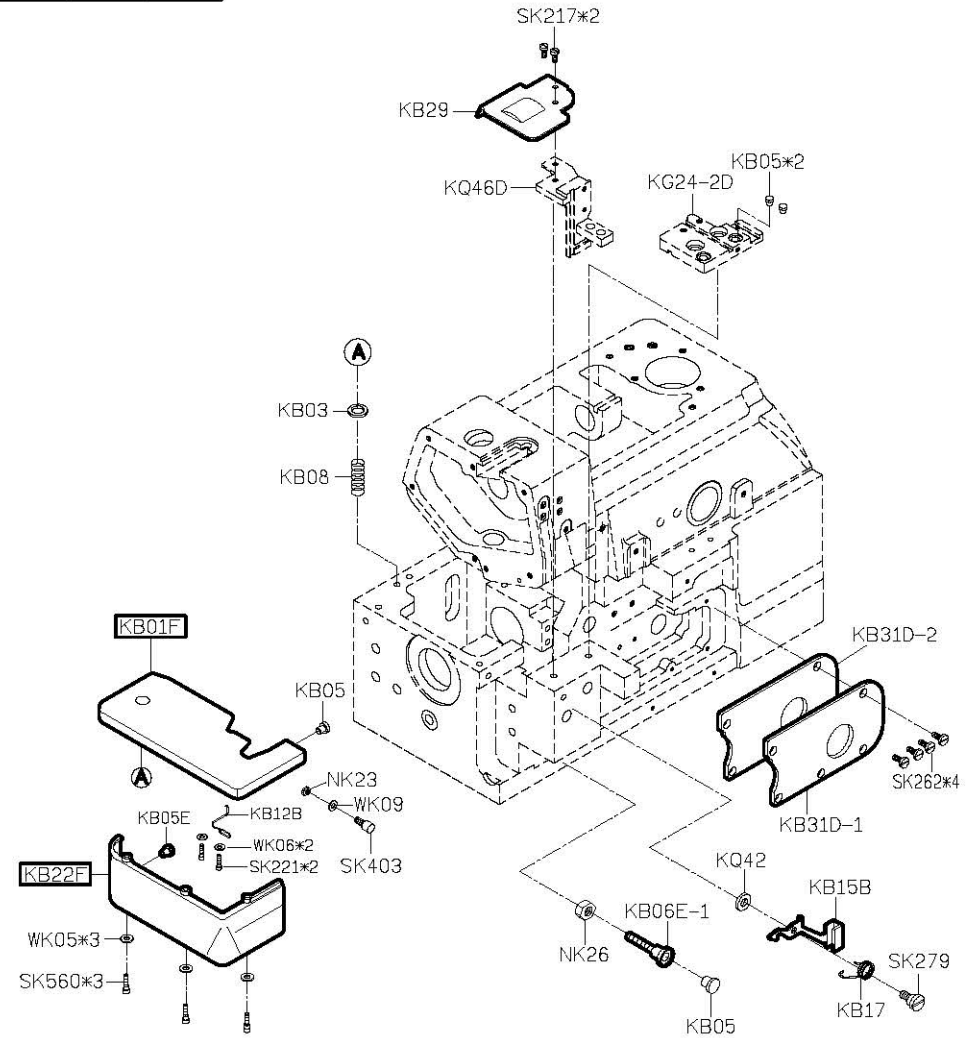

MODEL	STD	H1
PARTS NO	KF87	KF86

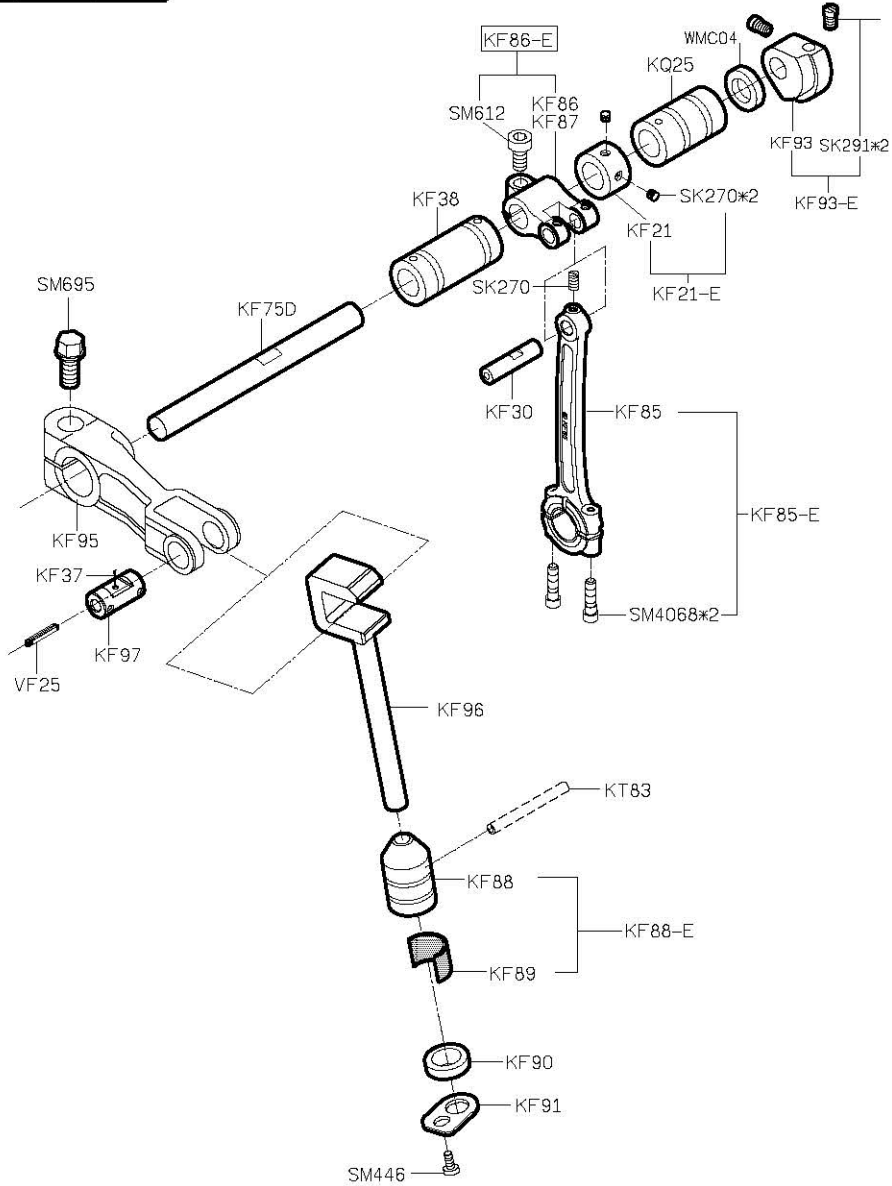

MODEL	三線車	四線車	五線車	六線車
PARTS NO	KG60F	KG60F	KG11F	KG11F
	KG471	KG472	KG35	KG35
	KG81	KG80	KG81	KG80
			KG31D	KG32D
			KG37	KG37
	KU18	KU18	KG39	KG39
	KG93	KG92	KG94	KG94
			KG30-1	
	SM251	SM251	SM250	SM250

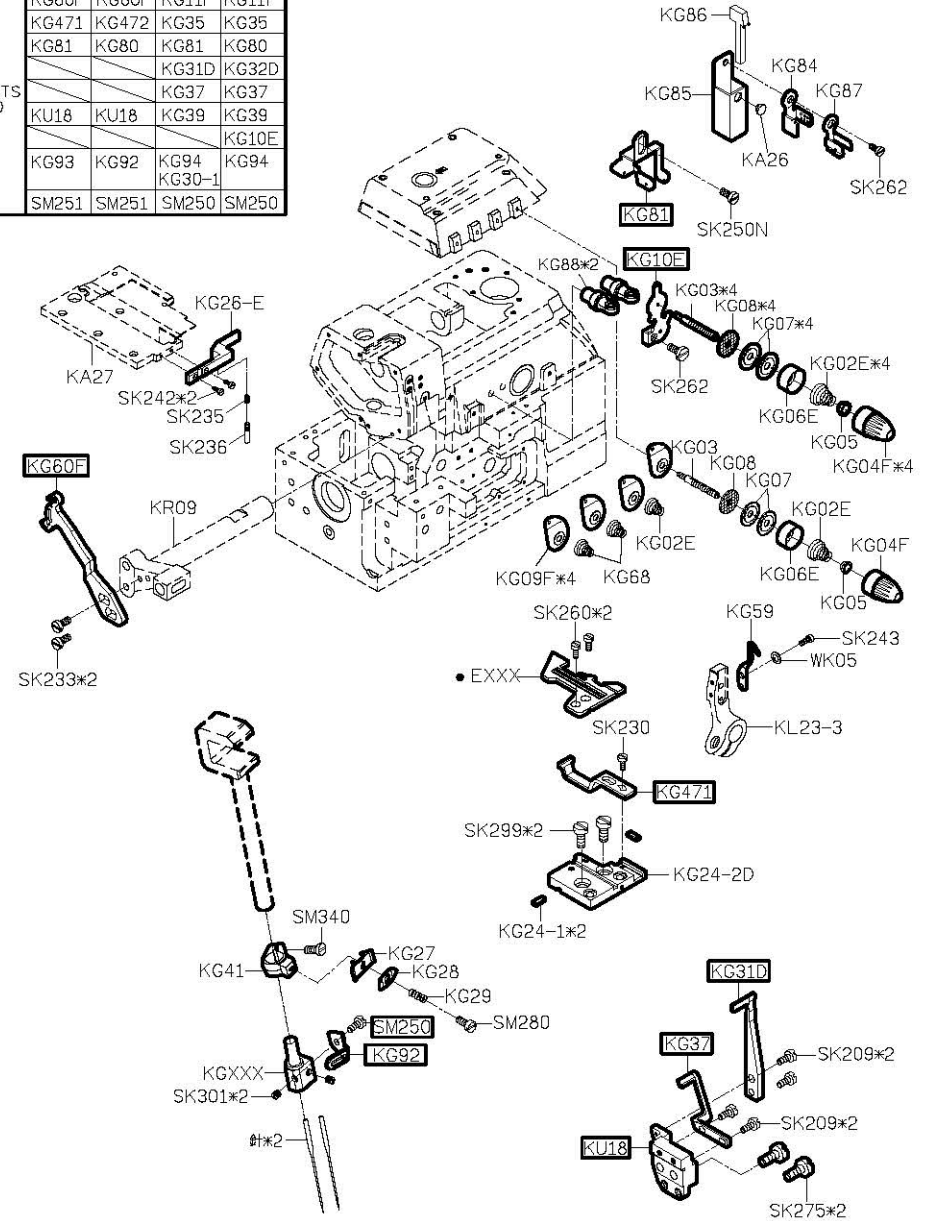

PARTS LIST FOR KJ GROUP

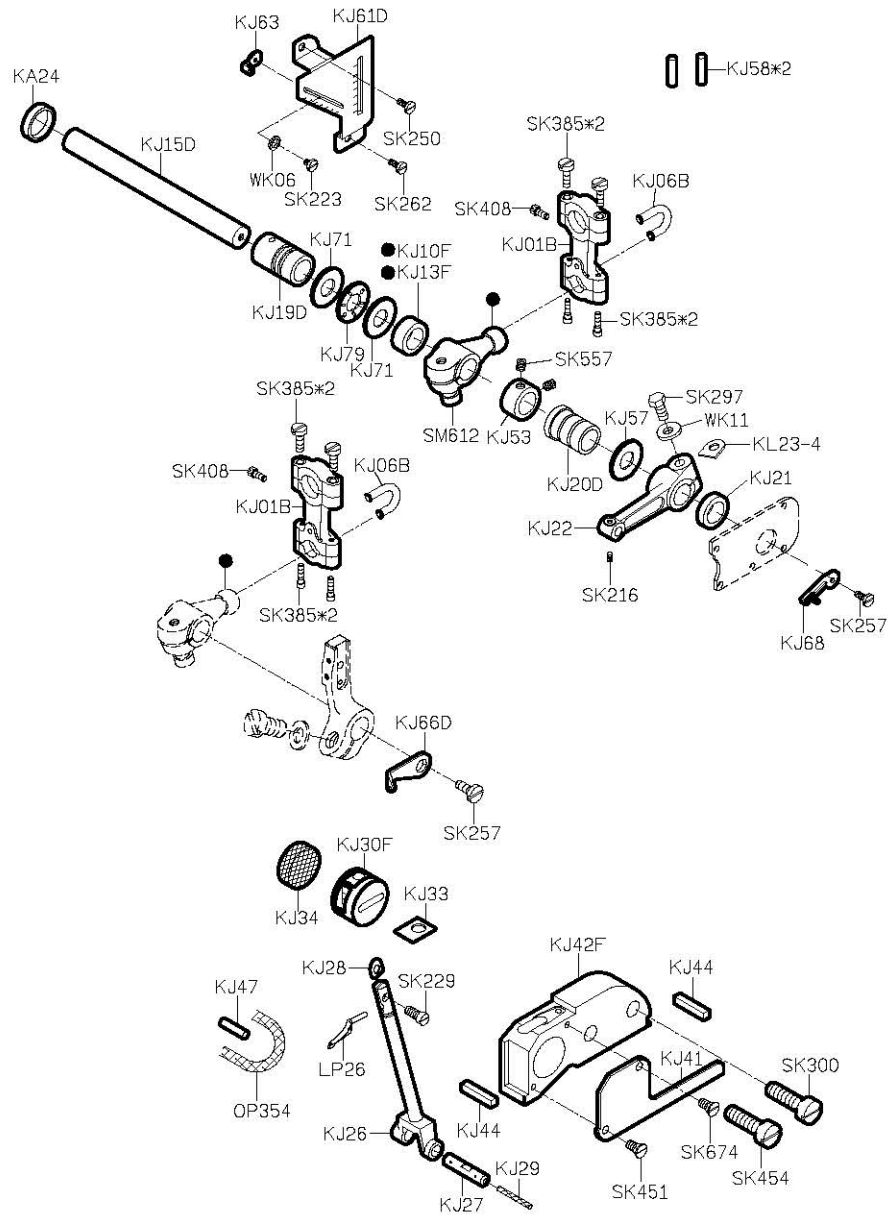

PARTS LIST FOR KL GROUP

MODEL	三四線車	五六線車
PARTS NO	KL57	KL16
	KL15	KL11
		KL09B-E

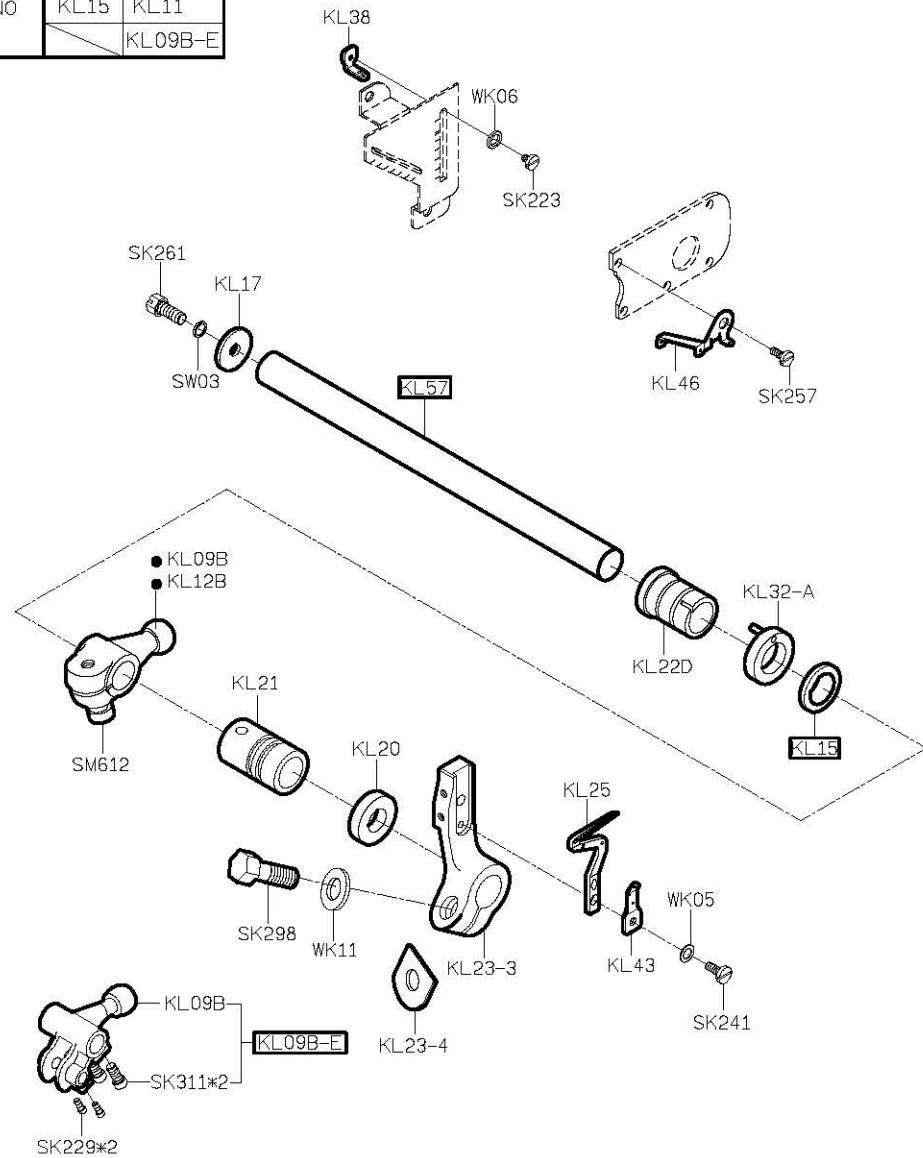

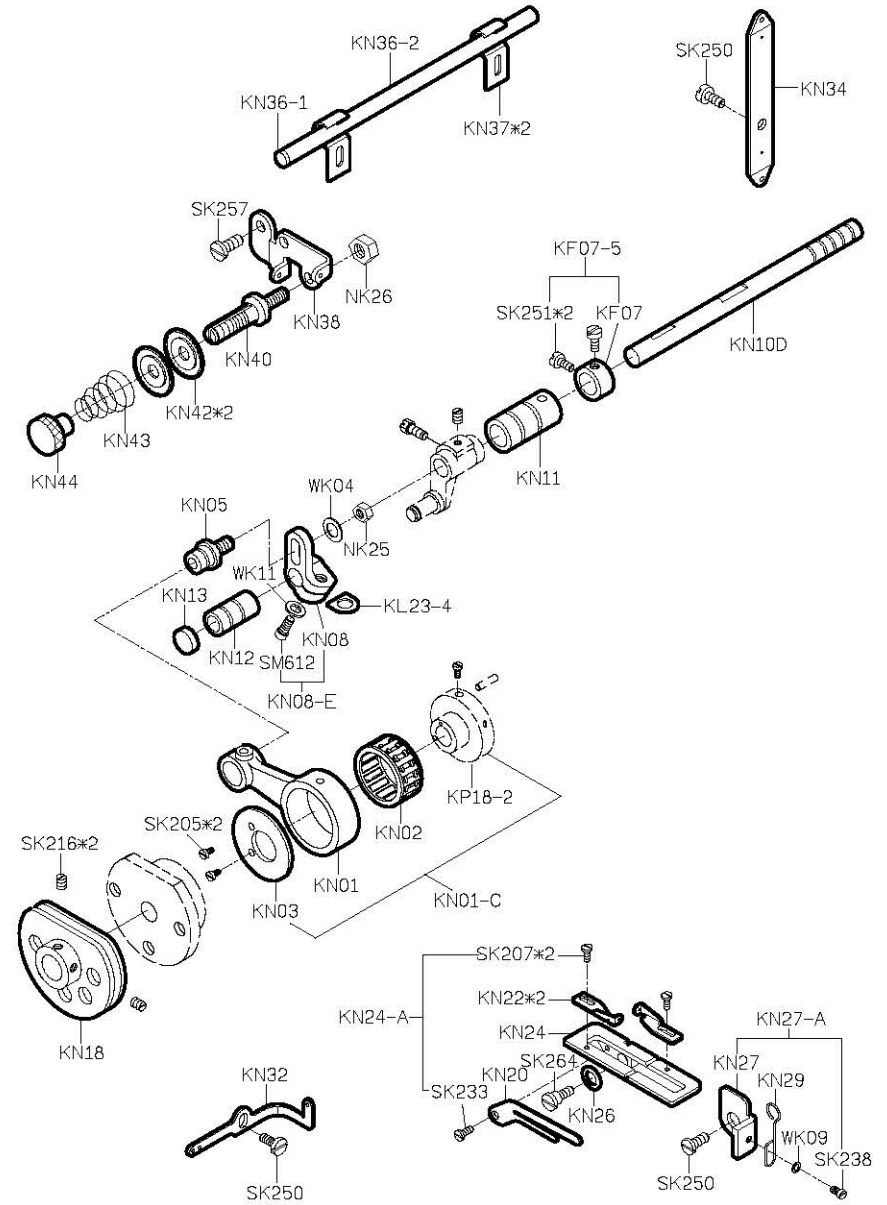
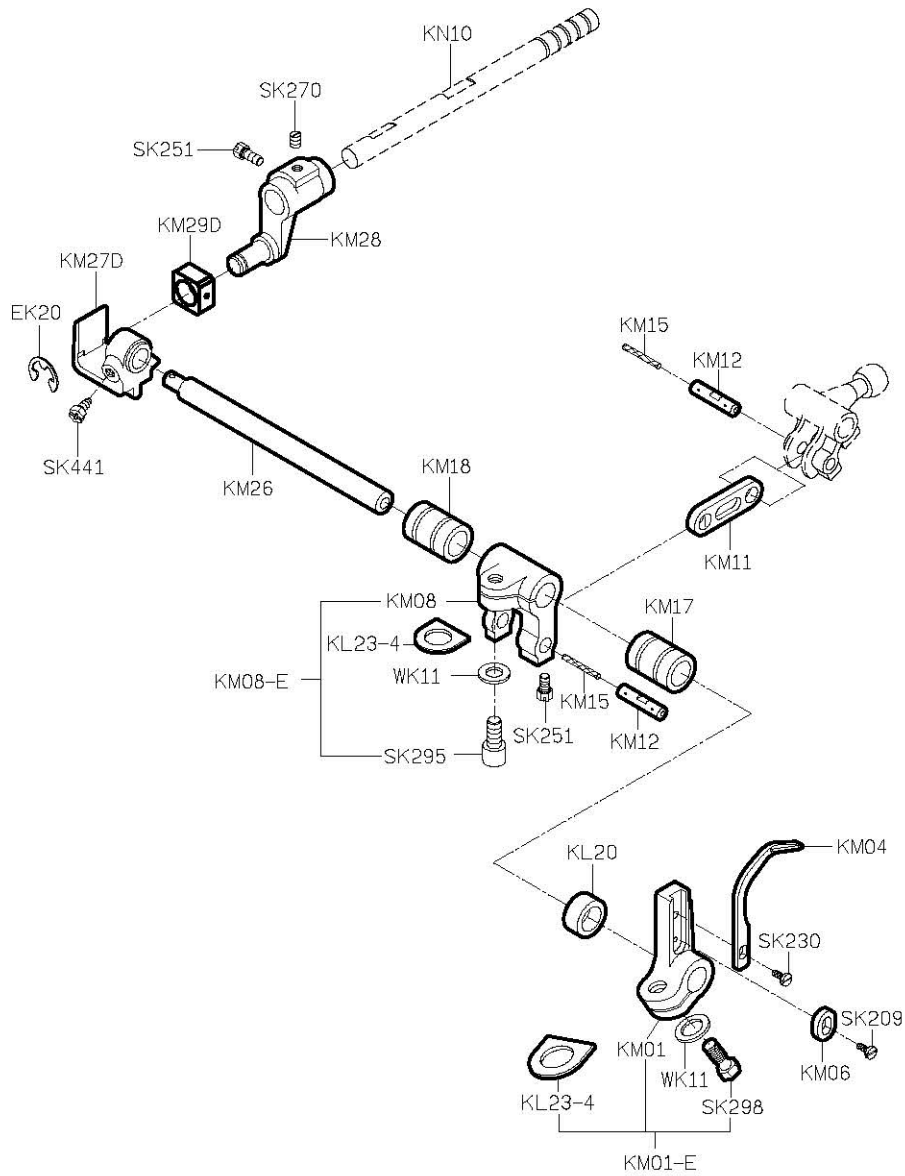

PARTS LIST FOR KP GROUP

PARTS LIST FOR KQ GROUP

MODEL	三四線車	五六線車
PARTS NO	KP59	KP18-2

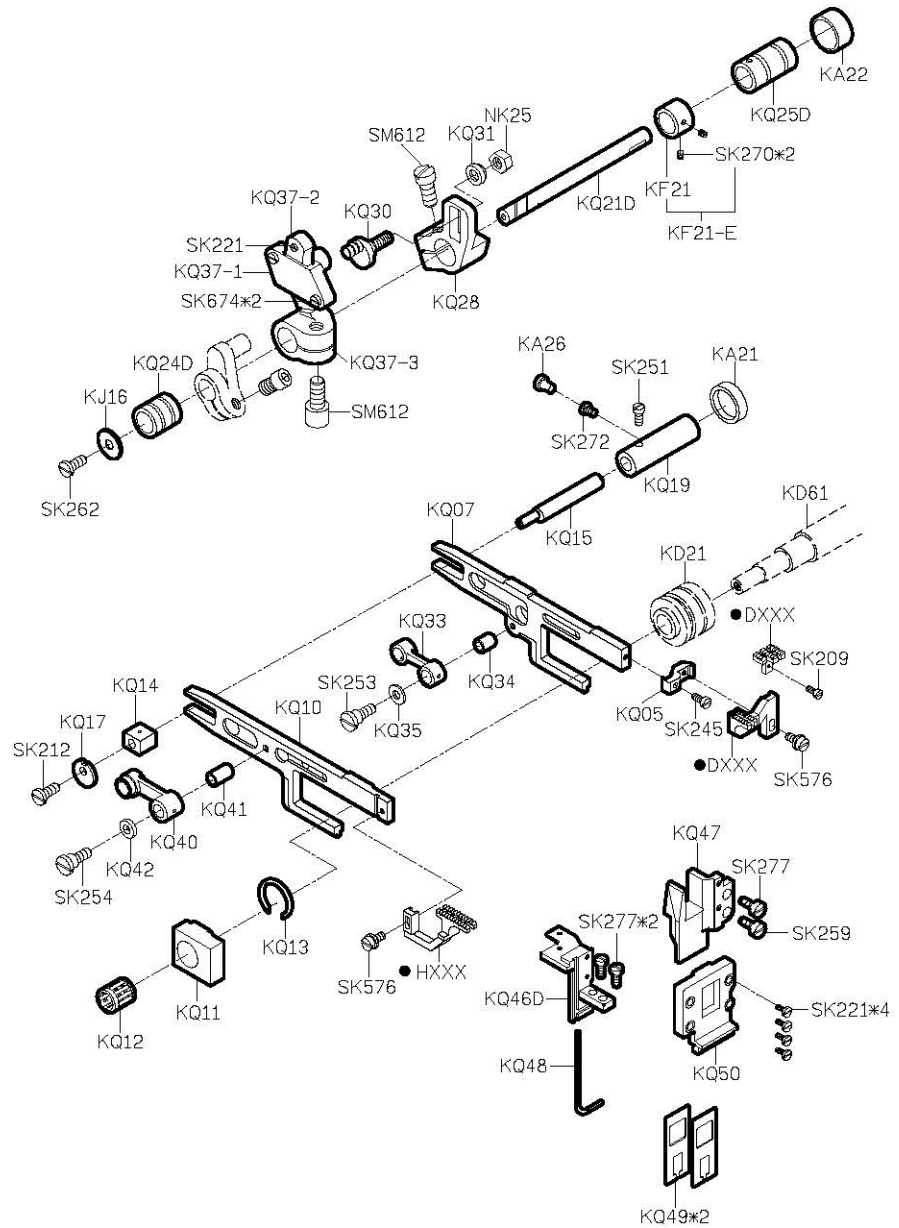
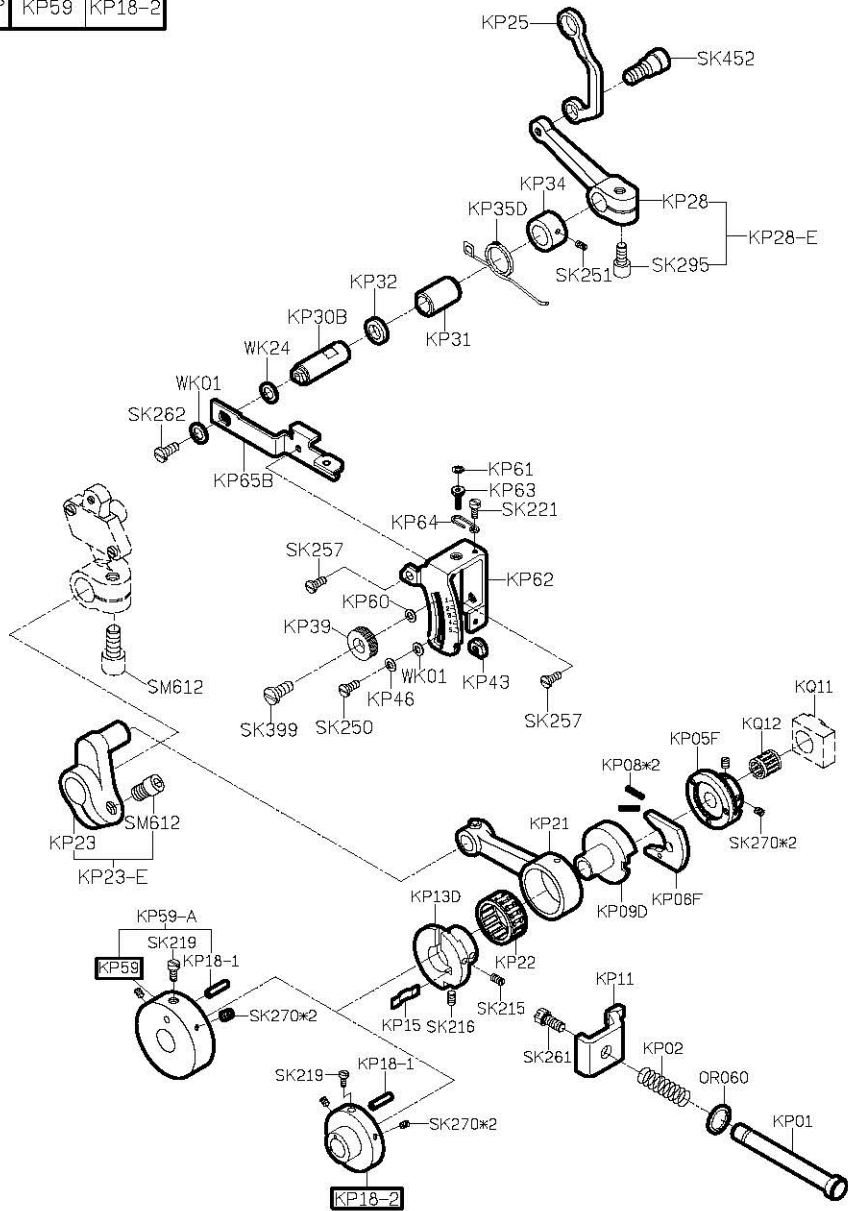

PARTS LIST FOR KT GROUP

PARTS LIST FOR KU GROUP

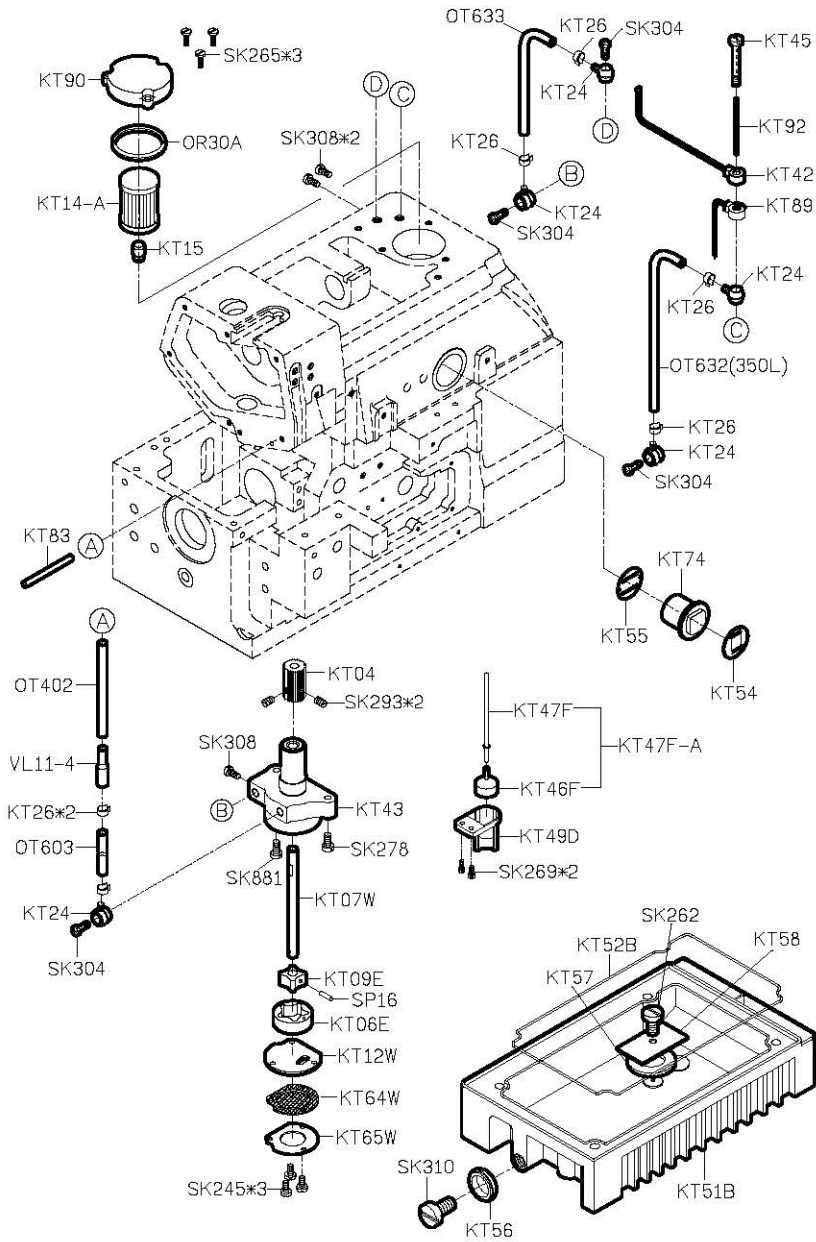

MODEL	三四線車	五、六線車
PARTS NO	KU40	KU39
	KU25	KU24
	KU15	KU14

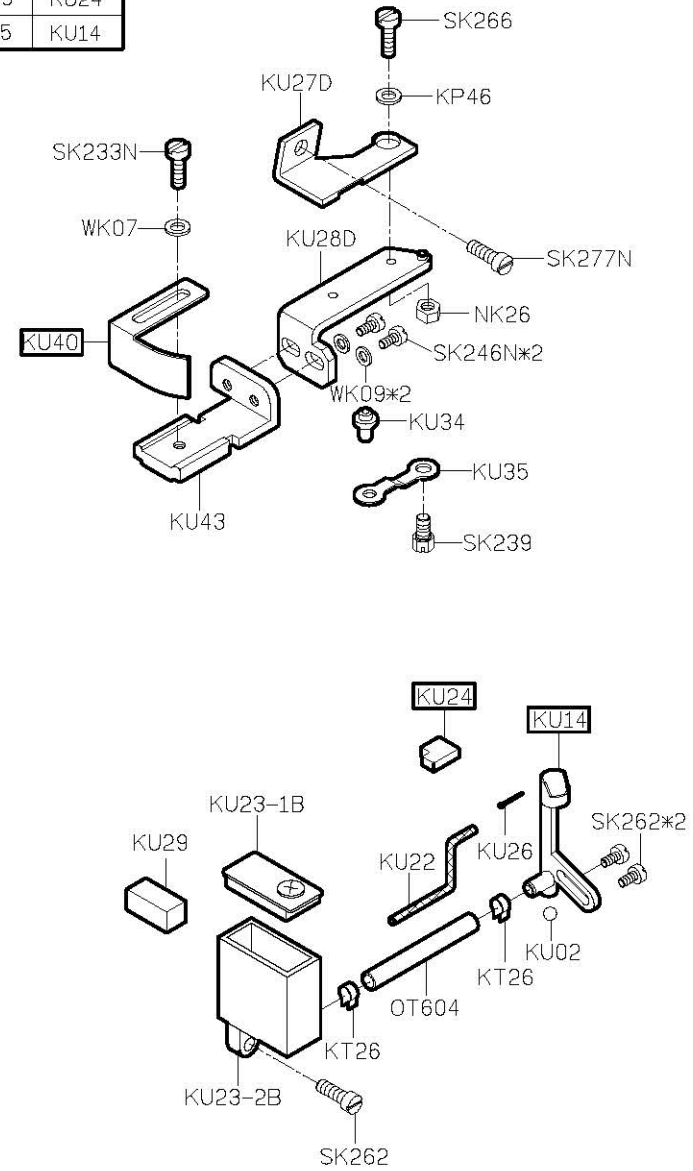

KW40E-3

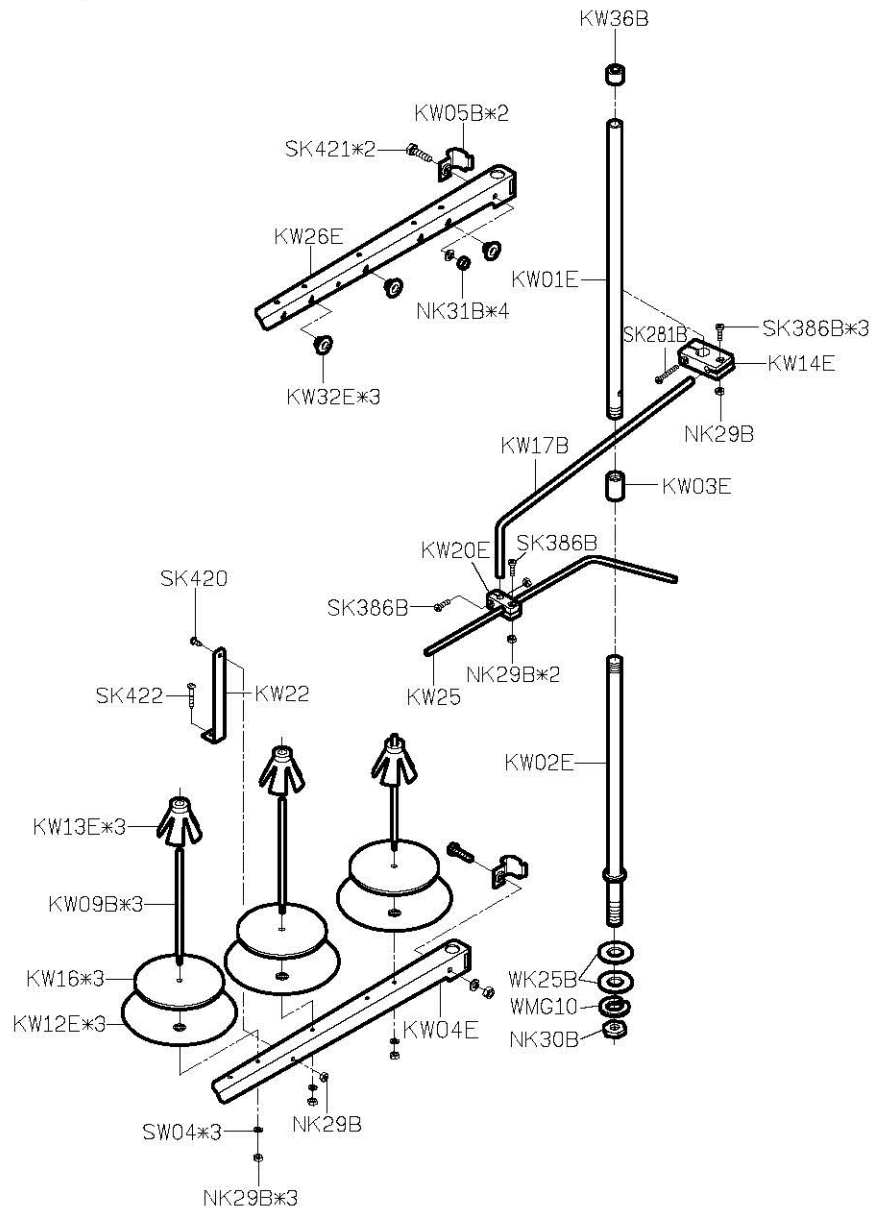

KW40E-4

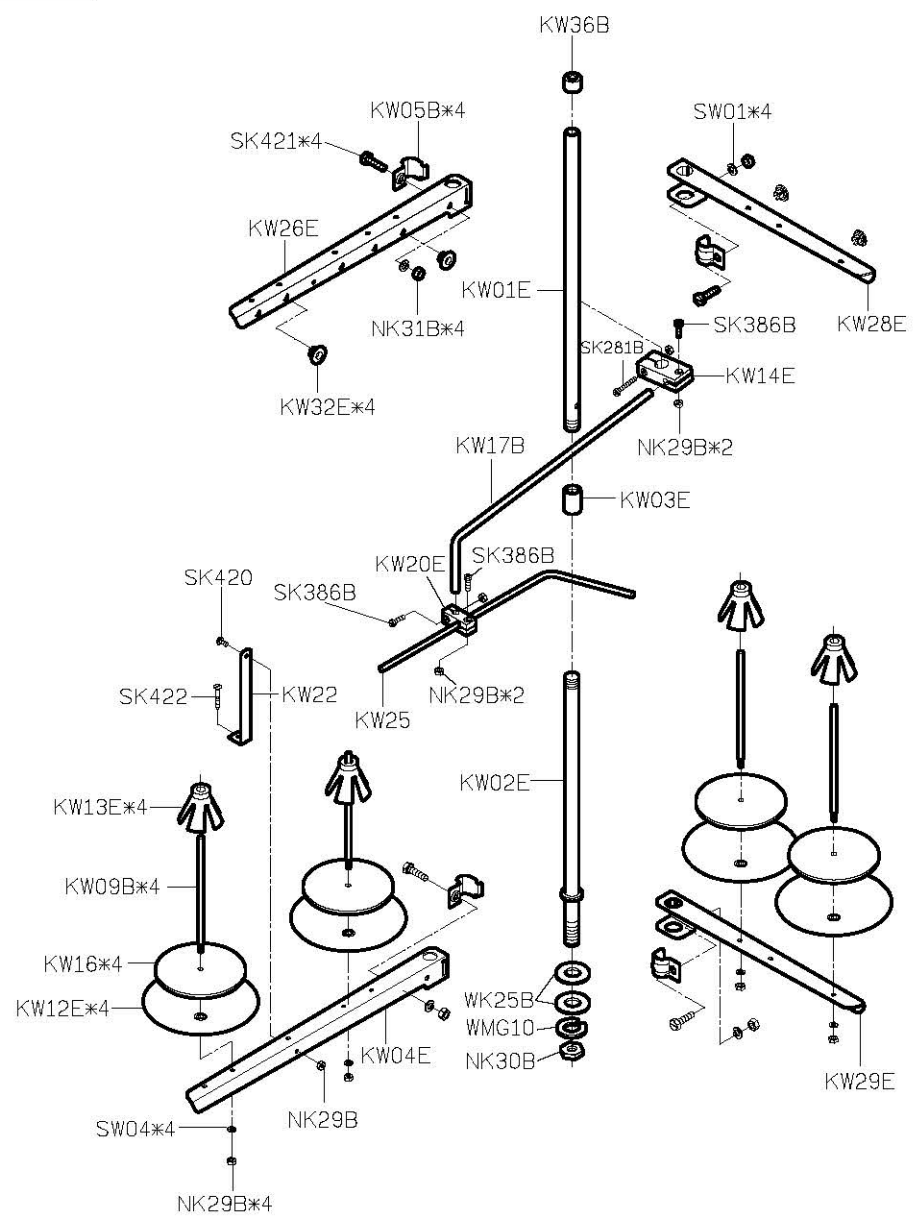

PARTS LIST FOR KW GROUP







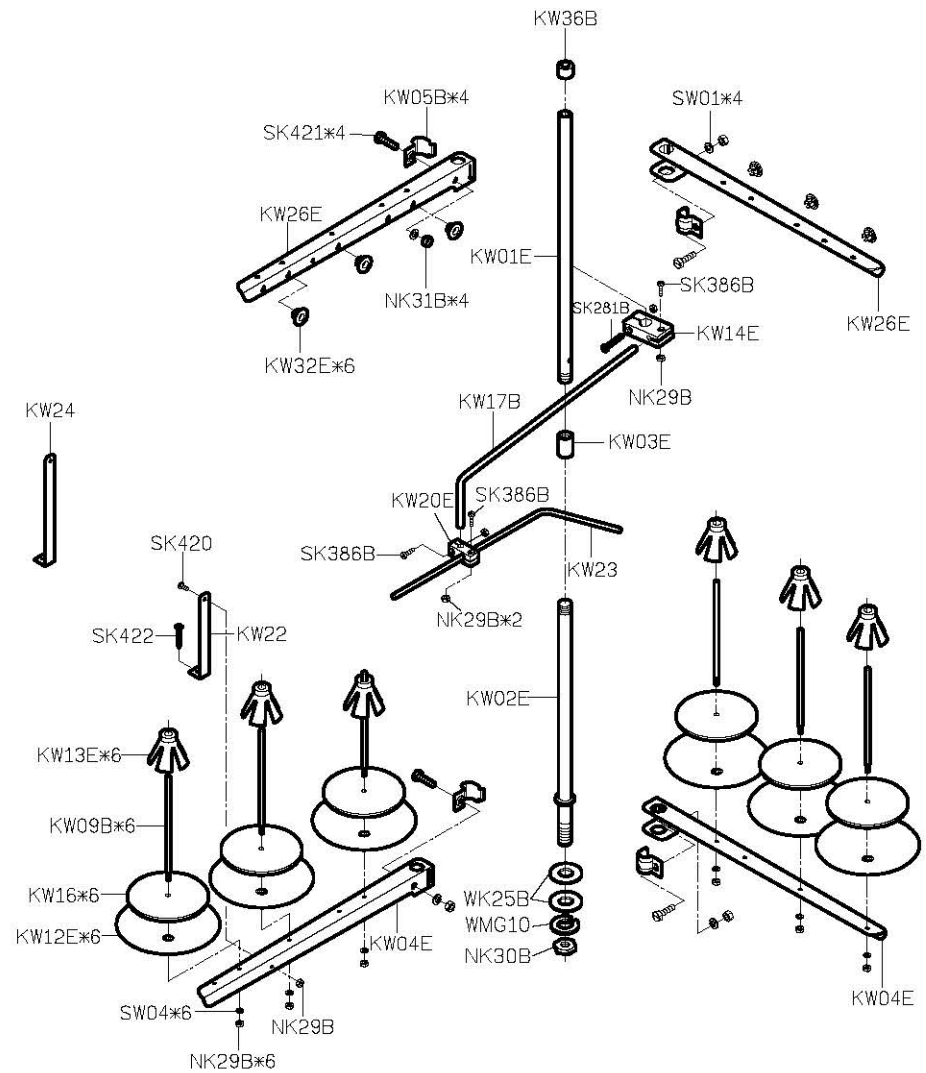
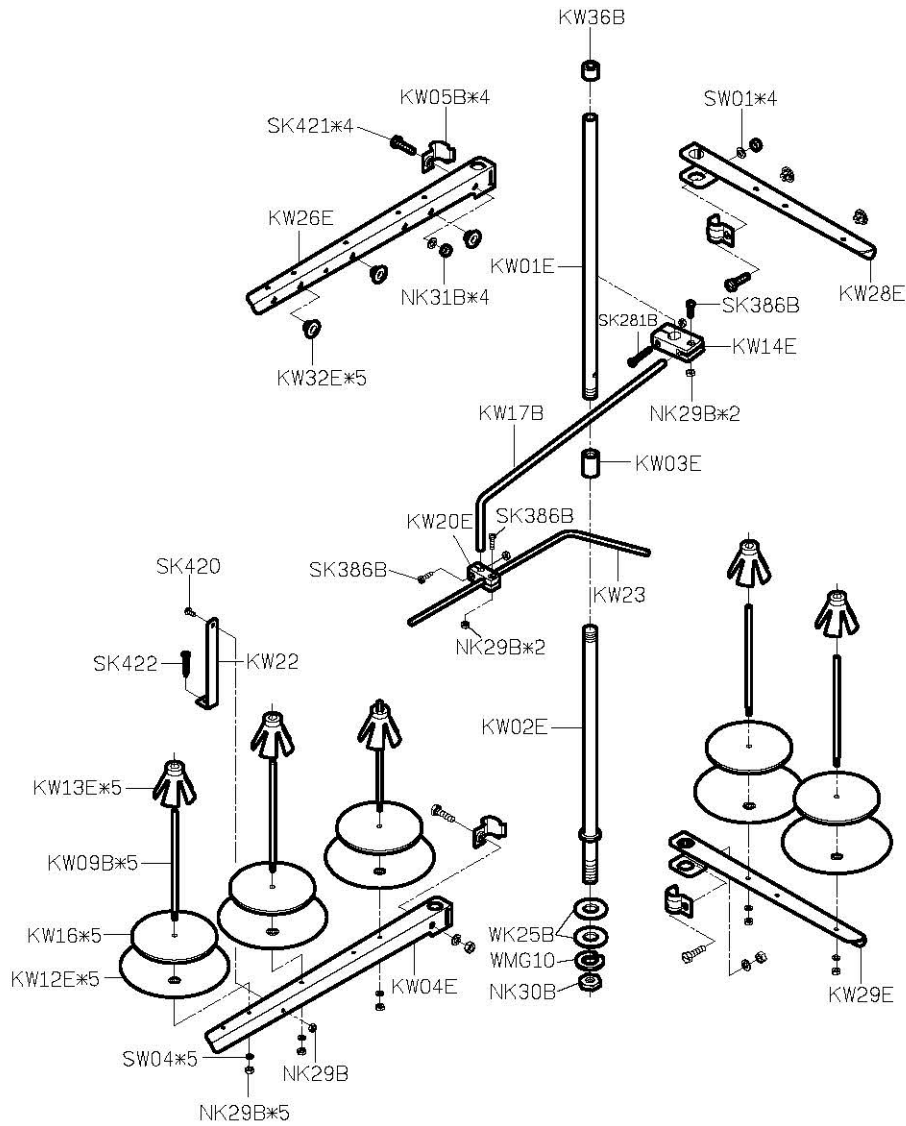

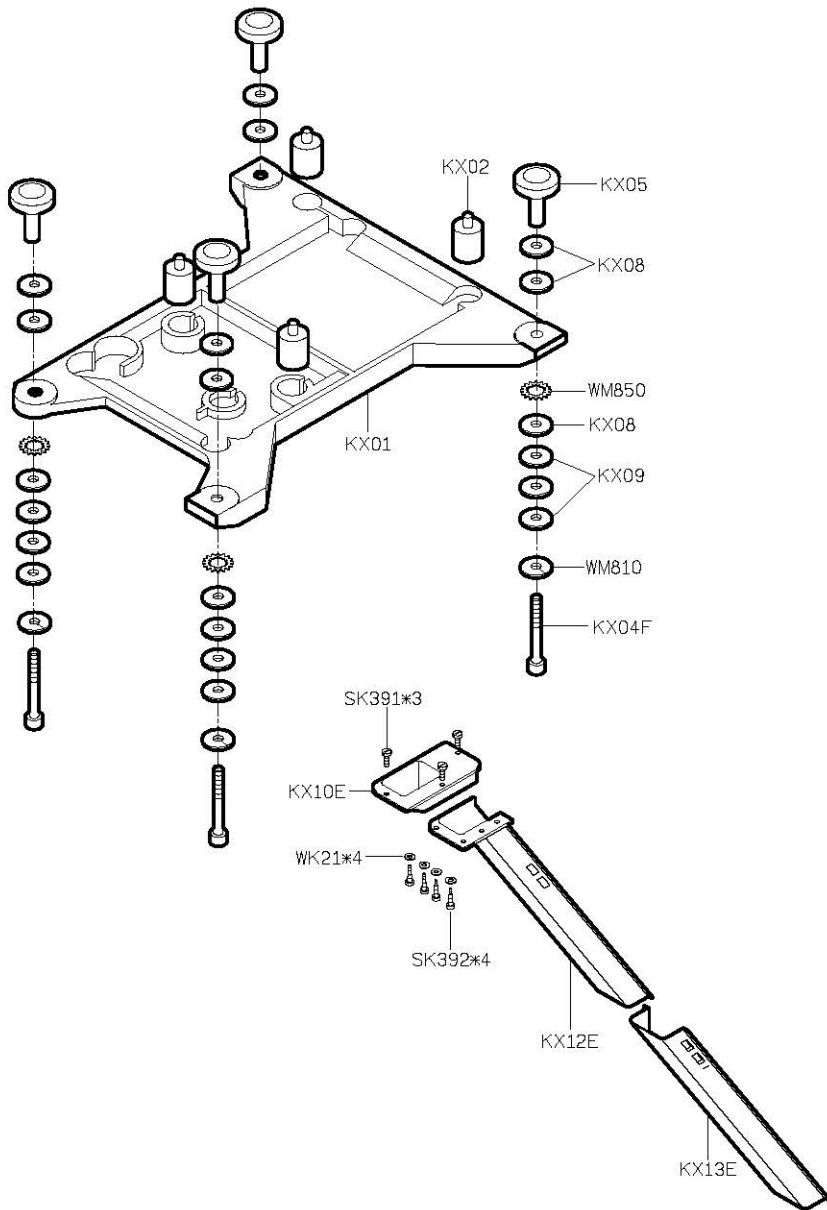

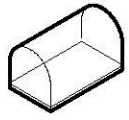
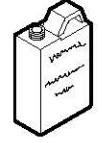









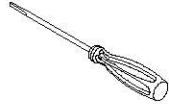
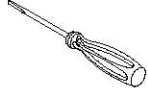

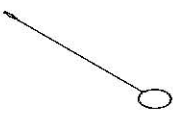



PARTS LIST FOR KW GROUP

KW40E-5

KW40E-6



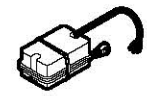

KY01 防塵罩 	KY02-A 油罐 	KY03 油壺 	KY04 漏斗 	KY05 油壺 
KY07 開口板手 	KY08 開口板手 	KY09 開口板手 	KY10 六角板手 	KY11 六角板手 
KY12 六角板手 	MY14 內六角螺絲起子 	KY16 一字起子 	KY17 一字起子 	KY18 鑷子 
KY19 穿線器 	KY20D 腳踏板 	KY21-A/MY21 鉤子/鍊條 	KY26F 工具袋 	KR35 下刀片 
KT14-A 濾油器 	KZ03 乾燥劑 	針*5 車針 	MY11 六角板手 	KZ08Q 使用說明書 
KZ08D-2 零件圖 	SK216*2 螺絲 	KC121-E 燈座電氣組 	SK392*2 螺絲 	KC146 照明電源開關包裝盒 

PARTS LIST FOR KZ GROUP

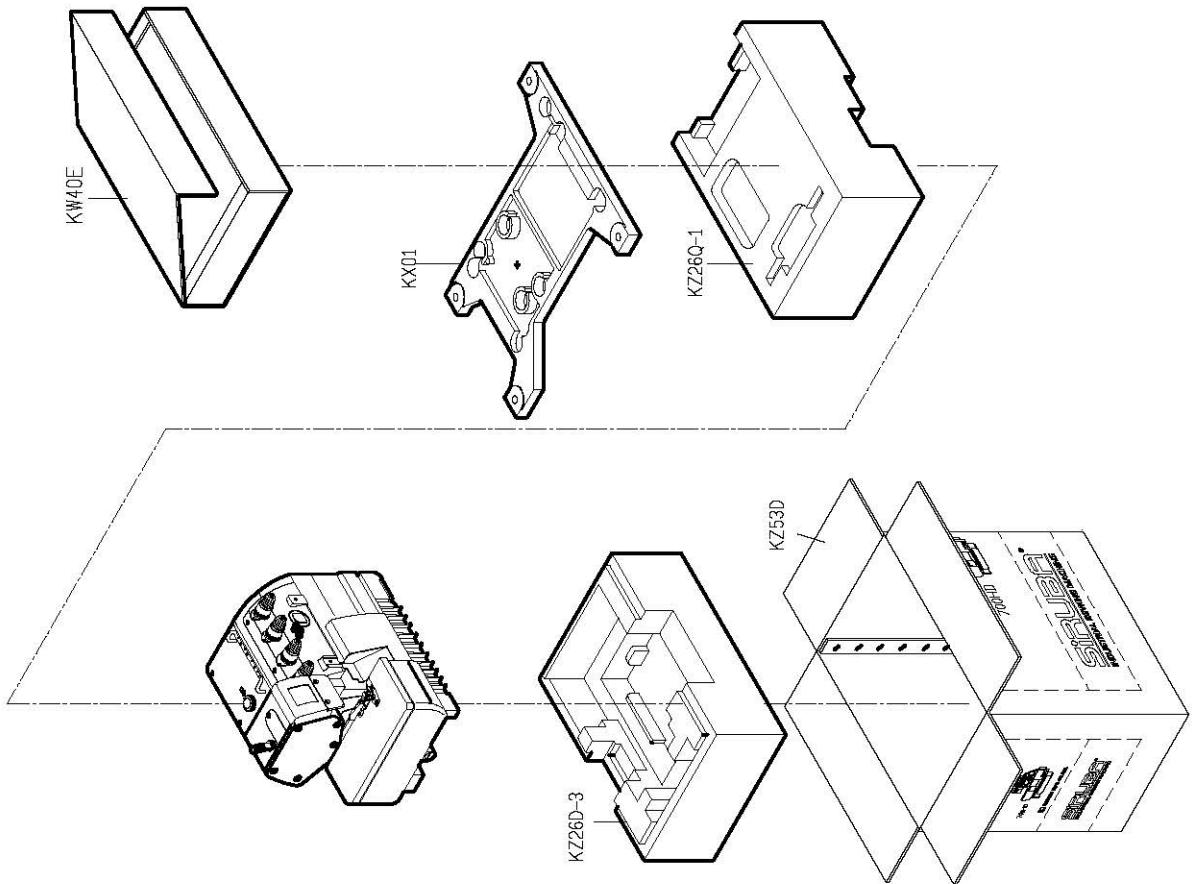



700HD

高林股份有限公司 KAULIN MFG. CO., LTD.