

SIRUBA®

銀箭牌工業用縫紉機
INDUSTRIAL SEWING MACHINE

700FS











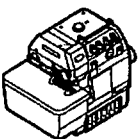





























零件圖 PARTS LIST



CE

 高林股份有限公司
KAULIN MFG. CO., LTD.

From the library of: Superior Sewing Machine & Supply LLC

	GAUGE NG SM																			
737FS-505F1-04	4	E304	D103	D102	H104	1.6	P152D-3	—	LP26	KG131	KF25	KJ09B	KJ10	#9	5.5			KL62	KL11	8000
737FS-505F1-04/ESS	4	E304	D103	D102	H104	1.6	P152D-3	—	LP26	KG131	KF25	KJ09B	KJ10	#9	5.5			KL62	KL11	8000
737FS-505F1-04/VT	4	E304	D103	D102	H104	1.6	P152D-3	—	LP26	KG131	KF25	KJ09B	KJ10	#9	5.5			KL62	KL11	8000
737FS-505F1-04/ESS/VT	4	E304	D103	D102	H104	1.6	P152D-3	—	LP26	KG131	KF25	KJ09B	KJ10	#9	5.5			KL62	KL11	8000
737FS-504M2-04	4	E324	D117	D116	H118	1.6	P987-3	KS62	LP26	KG131	KF26	KJ11B	KJ13	#11	6.5			KL60	KL11	6300
737FS-504M2-04/VT	4	E324	D117	D116	H118	1.6	P987-3	KS62	LP26	KG131	KF26	KJ11B	KJ13	#11	6.5			KL60	KL11	6300
737FS-504M2-04/LFC-2S	4	E324	D117	D116	H118	1.6	P111-3	KS62	LP26	KG131	KF26	KJ11B	KJ13	#11	6.5			KL60	KL11	6300
747FS-514M2-24	2 4	E434	D117	D116	H118	1.6	P987-4	KS62	LP26	KG142	KF26	KJ11B	KJ13	#11	5.5			KL60	KL11	6000
747FS-514M2-24/VT	2 4	E434	D117	D116	H118	1.6	P987-4	KS62	LP26	KG142	KF26	KJ11B	KJ13	#11	5.5			KL60	KL11	6000
747FS-514M2-24/CT	2 4	E424	D103	D116	H118	1.6	P987-4	KS62	LP26	KG142	KF26	KJ11B	KJ13	#11	5.5			KL60	KL11	6000
747FS-514M4-24	2 4	E424	D103	D116	H118	1.6	P987-4	KS62	LP26	KG142	KF25	KJ69	KJ10	#11	6.5			KL62	KL11	7500

規格件表 CONVERSION CHART

PARTS LIST FOR KA GROUP

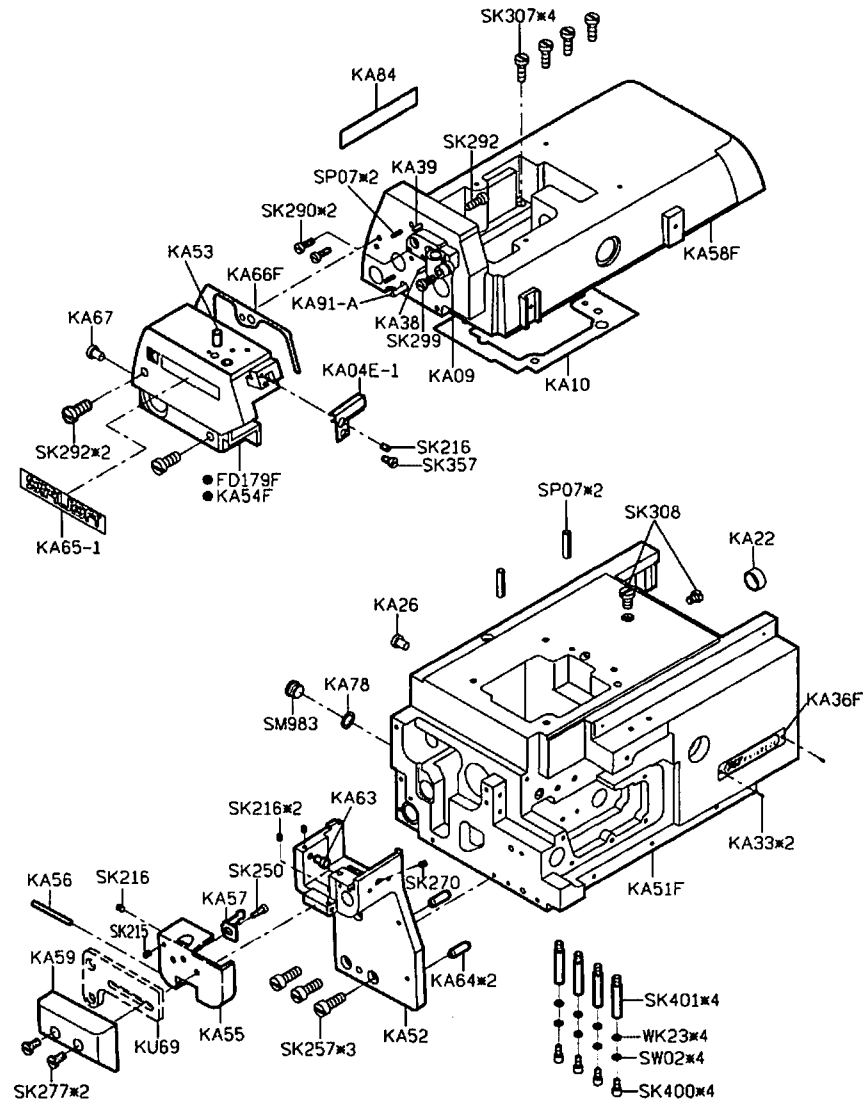

PARTS LIST FOR KB GROUP

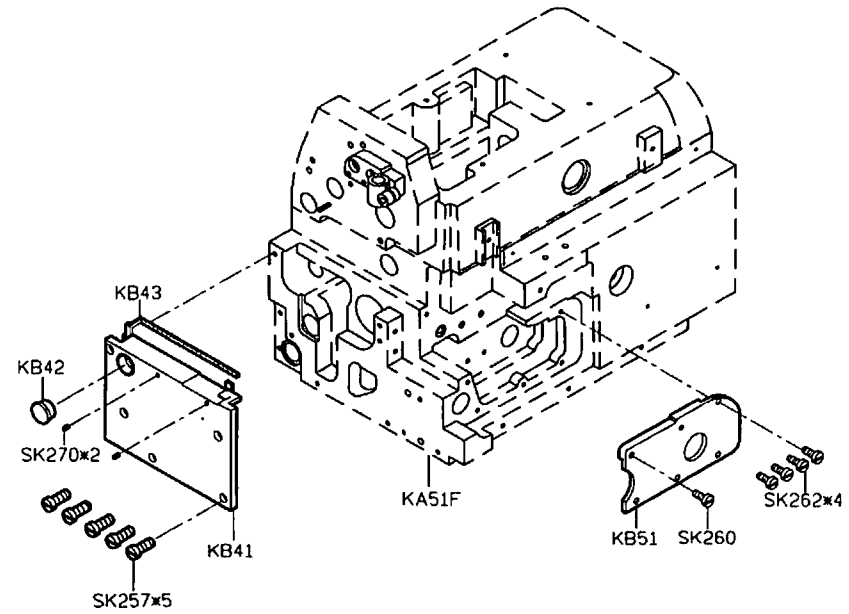

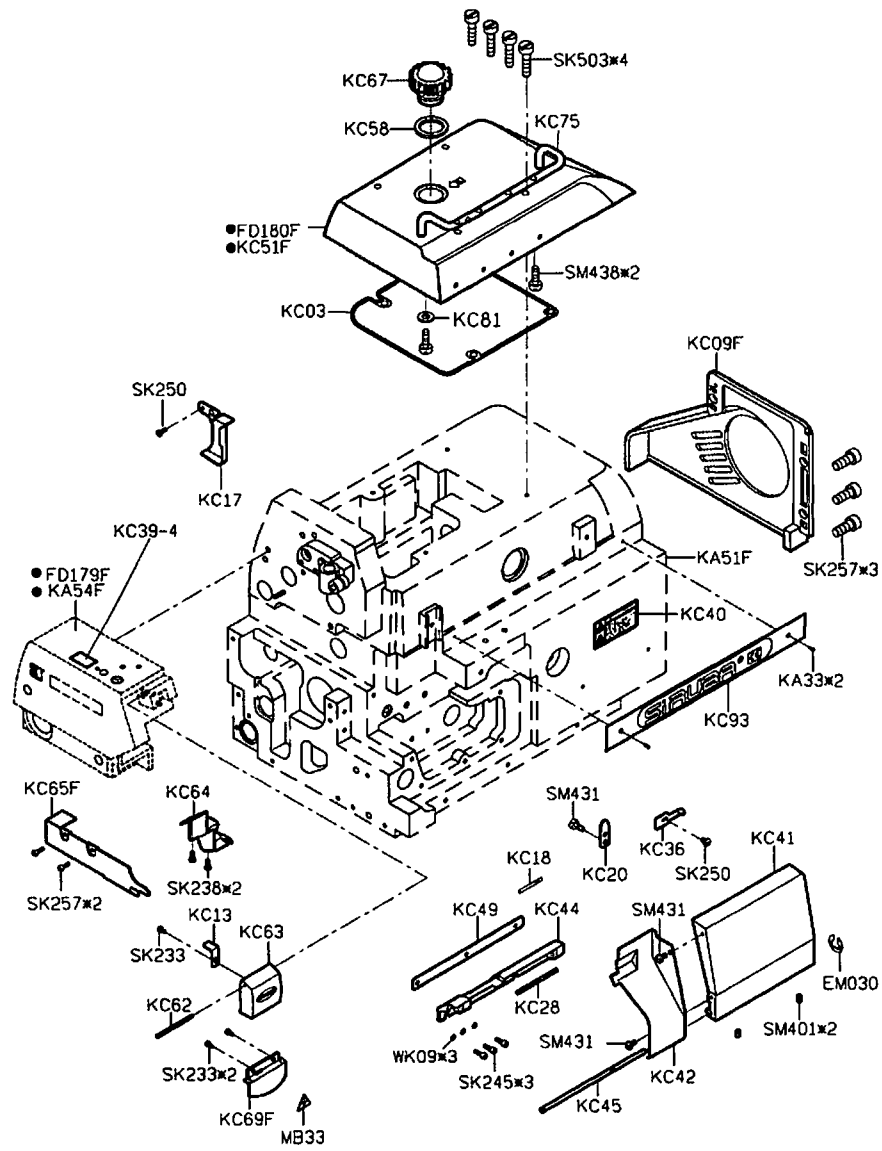

PARTS LIST FOR KC GROUP

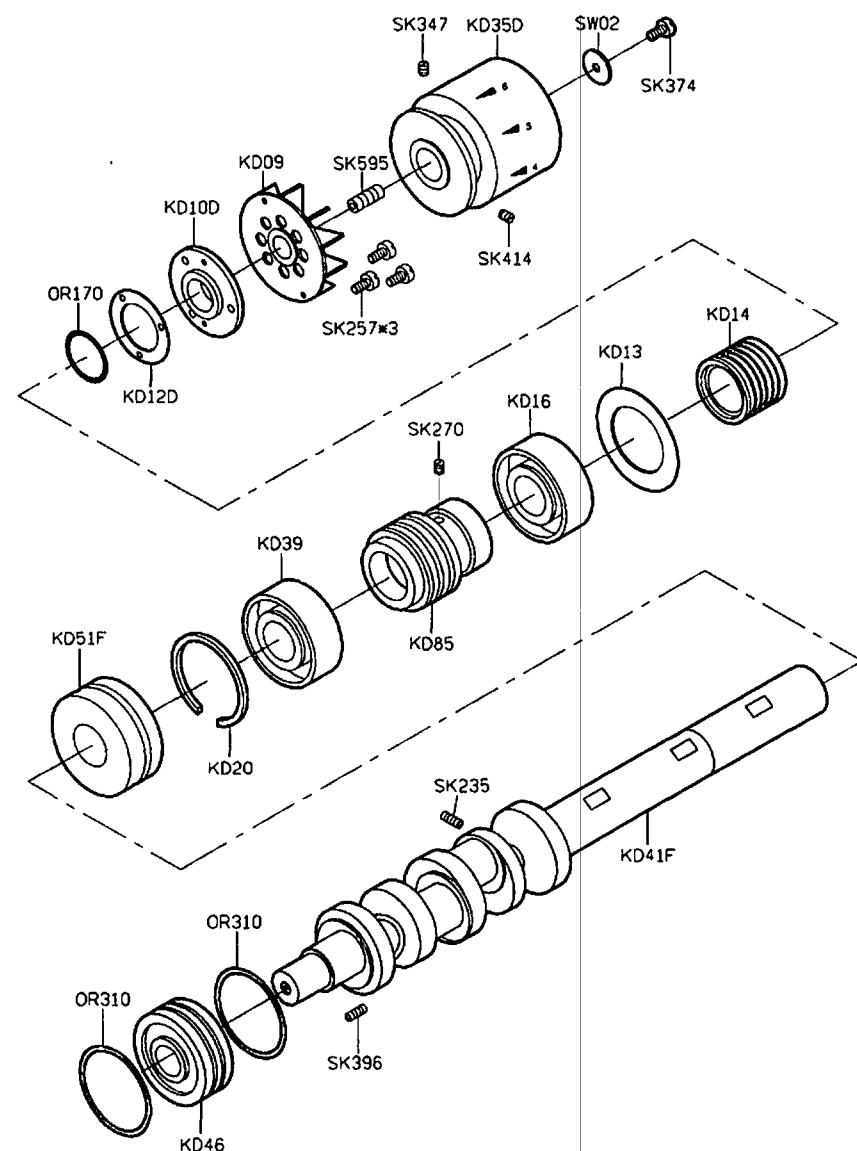

PARTS LIST FOR KD GROUP

PARTS LIST FOR KF GROUP

PARTS LIST FOR KG GROUP

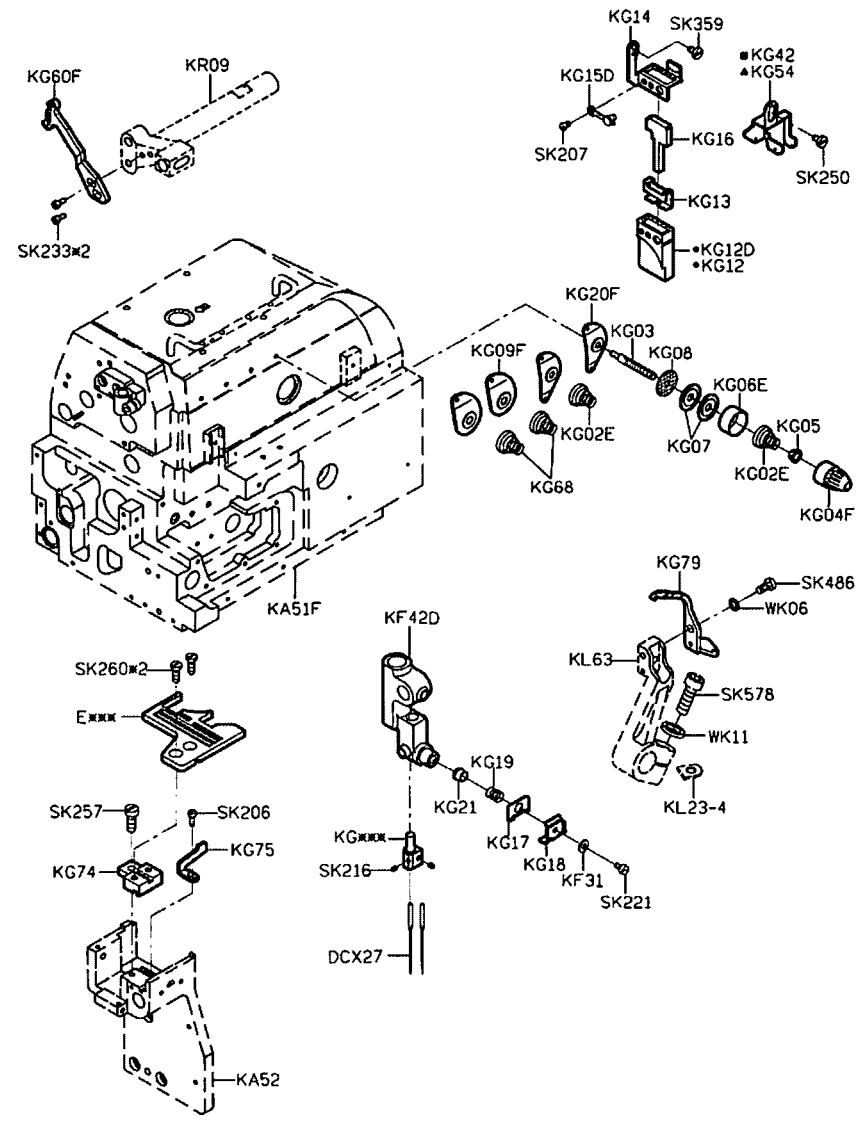
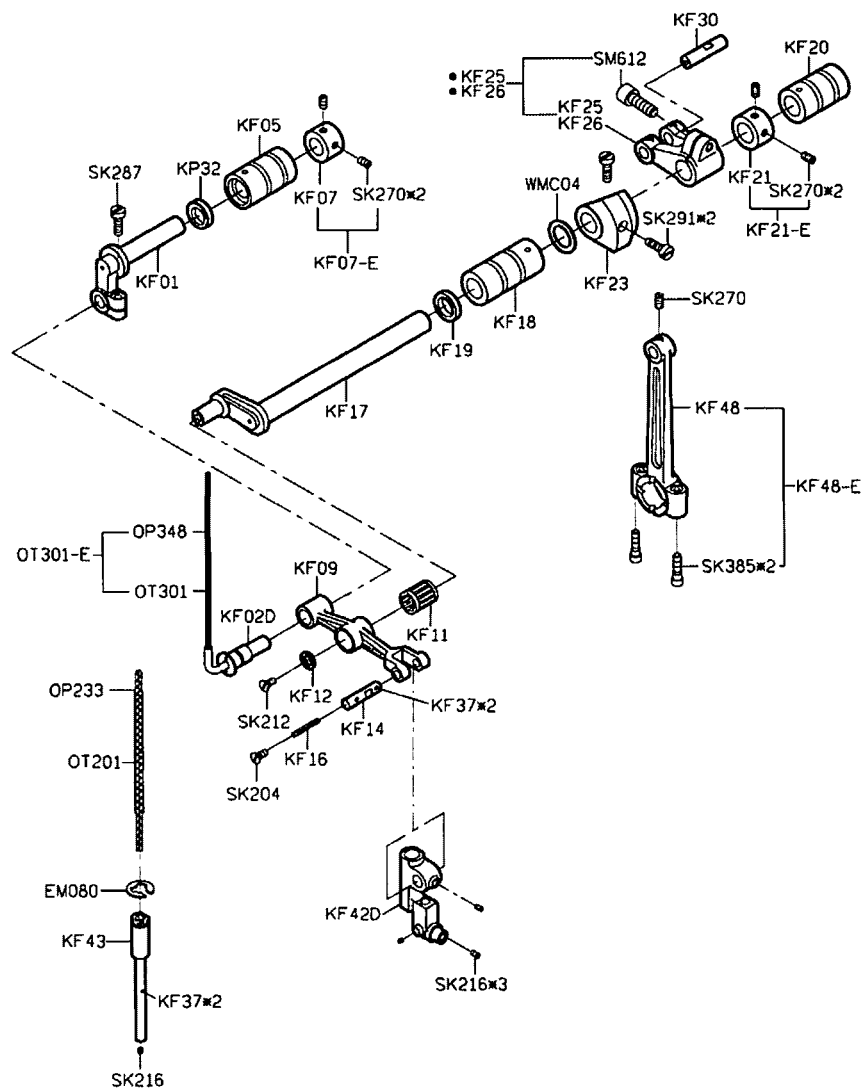

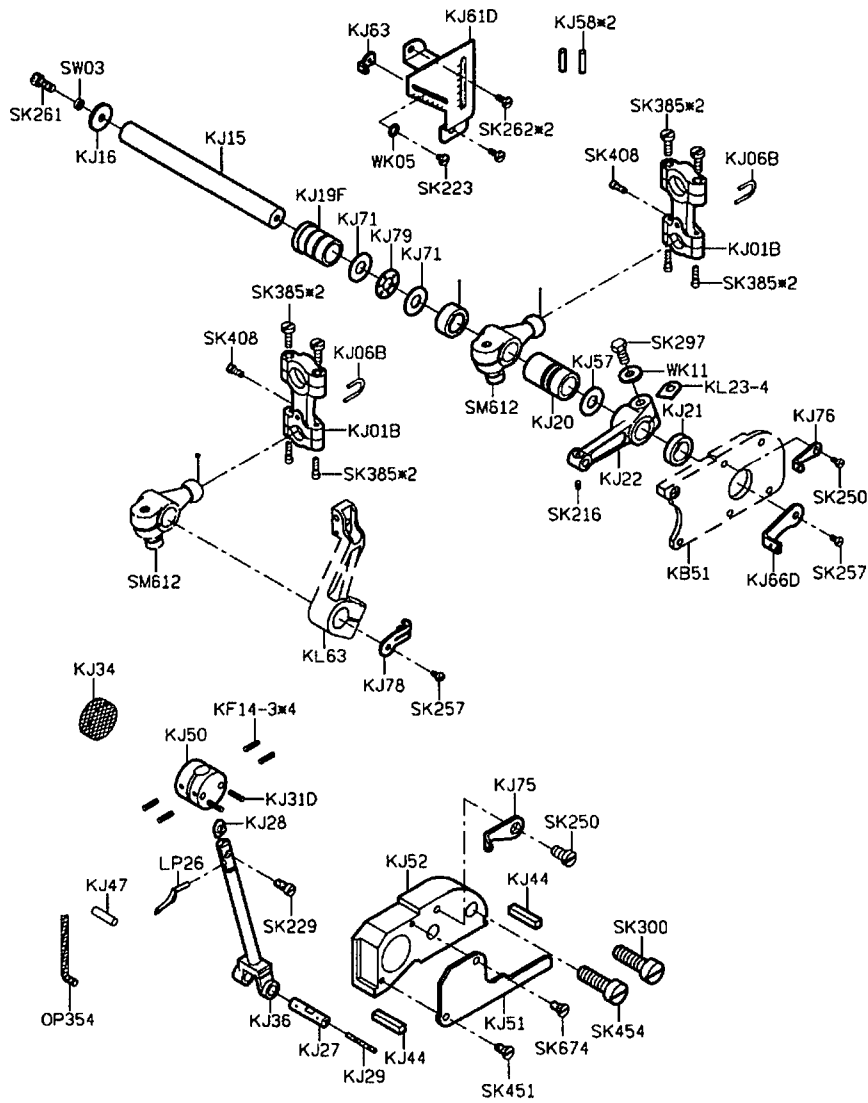

PARTS LIST FOR KJ GROUP

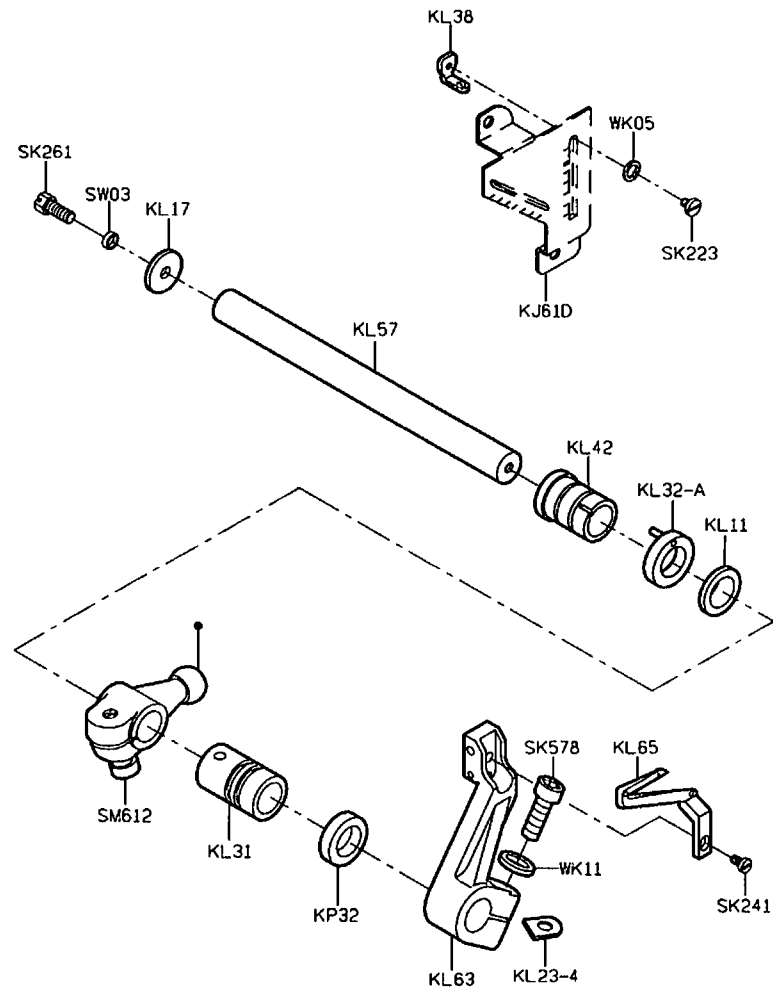

PARTS LIST FOR KL GROUP

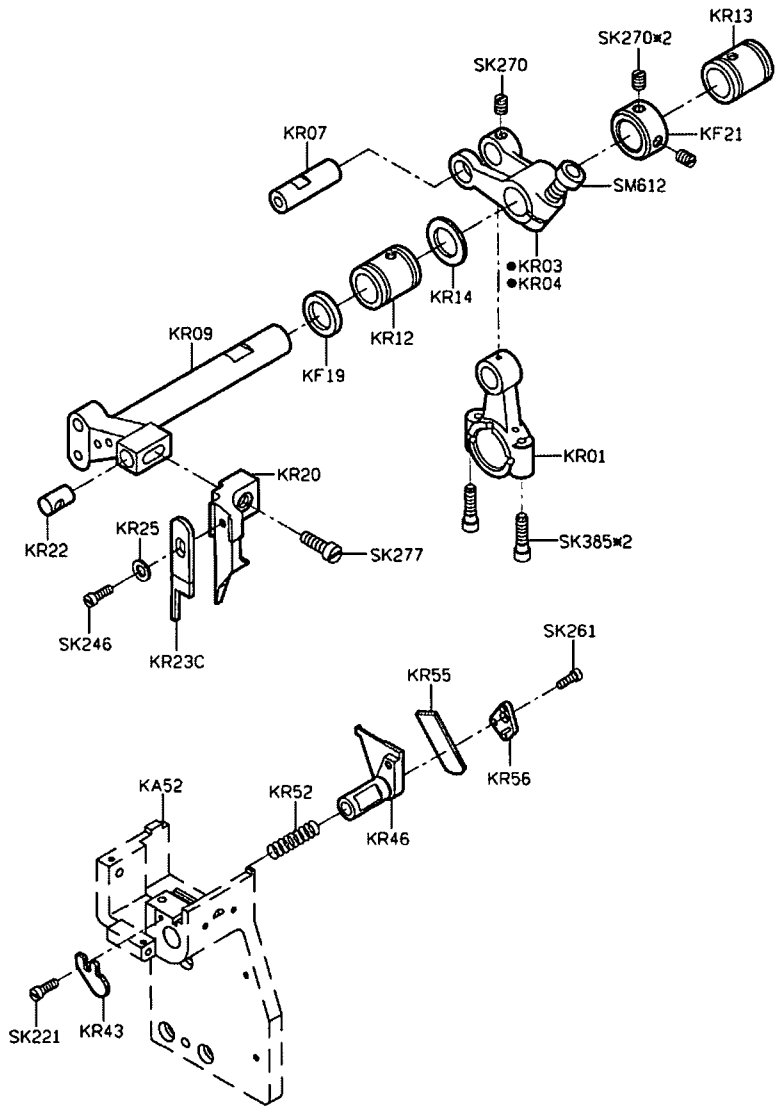

PARTS LIST FOR KR GROUP

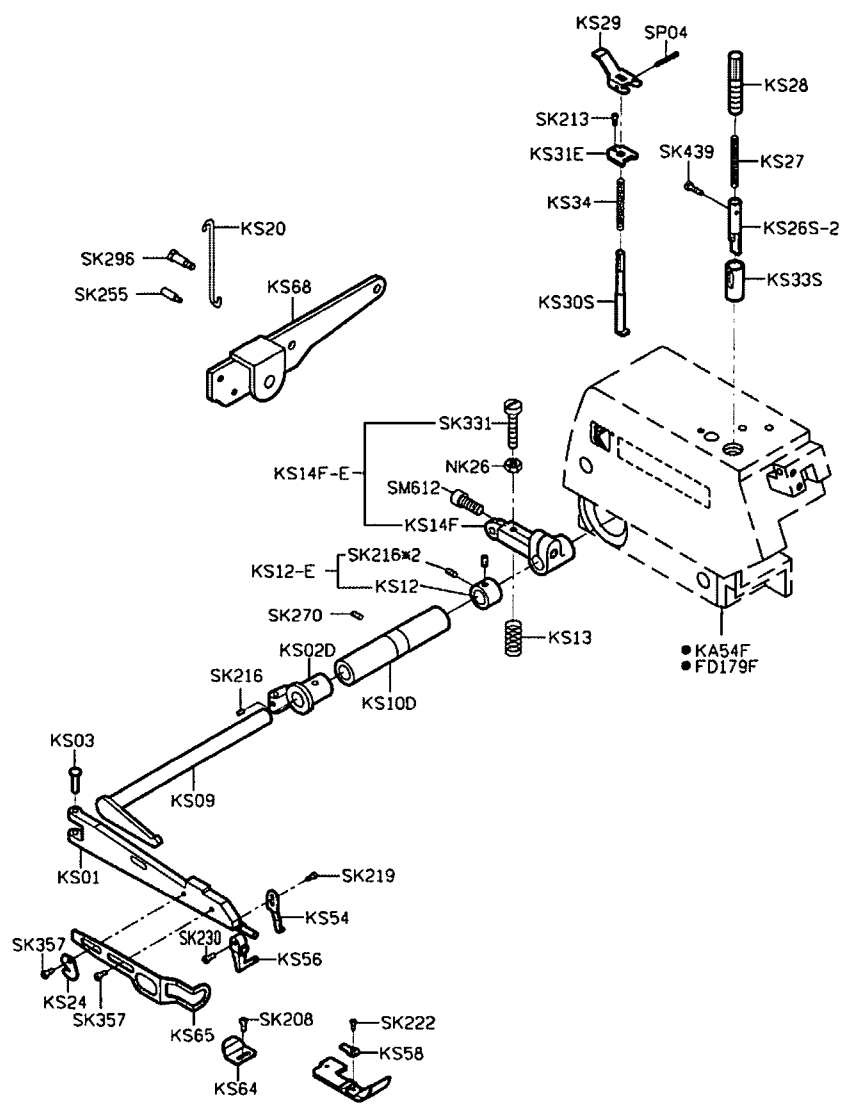

PARTS LIST FOR KS GROUP

PARTS LIST FOR KT GROUP

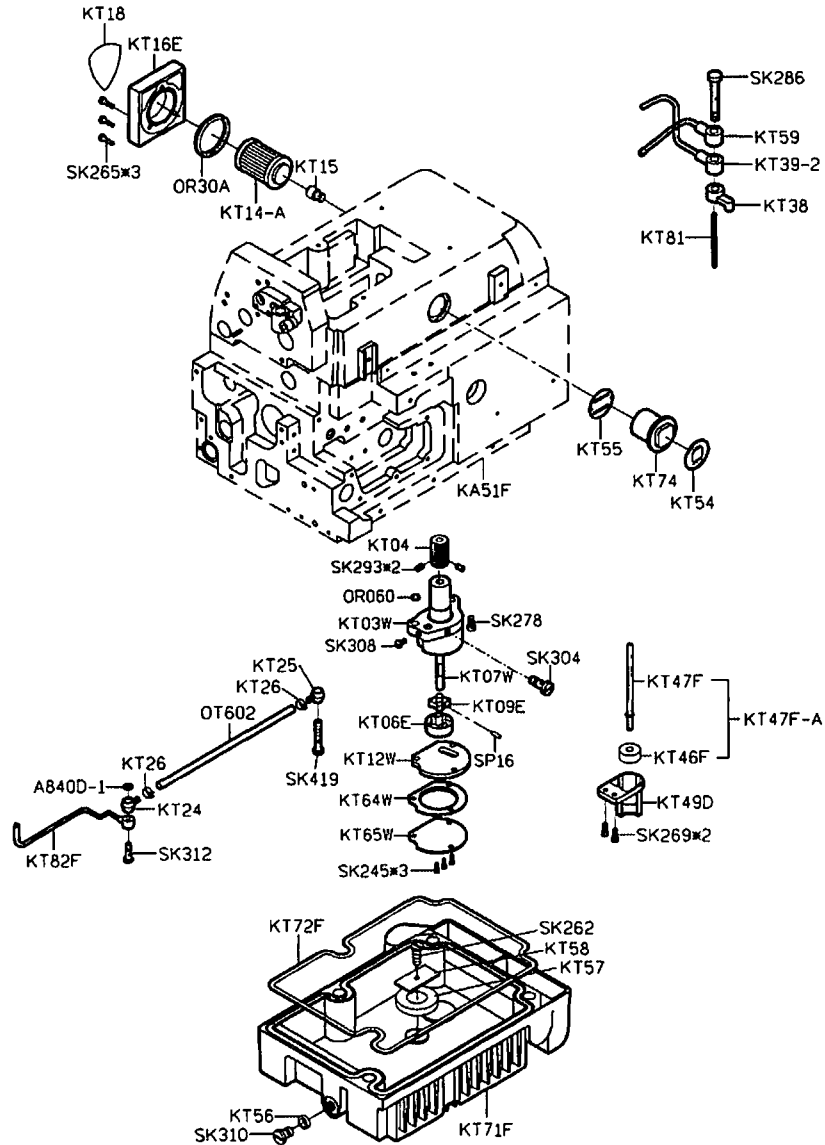

PARTS LIST FOR KU GROUP

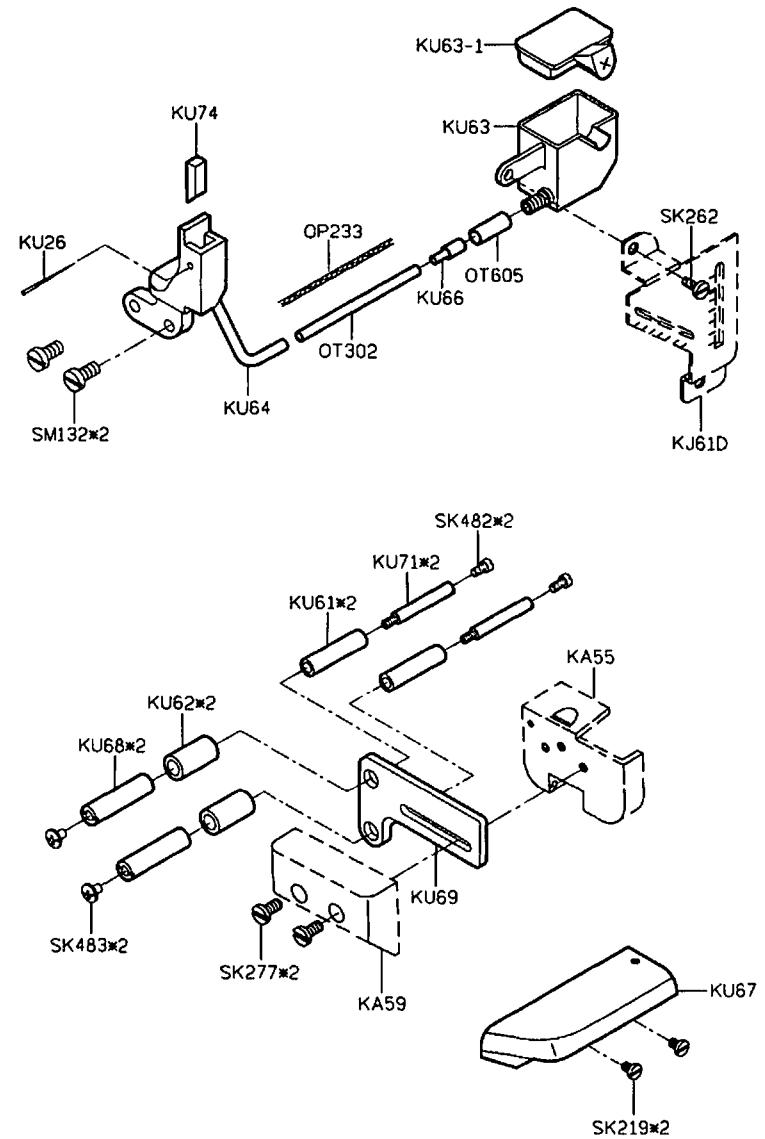

KW40E-3

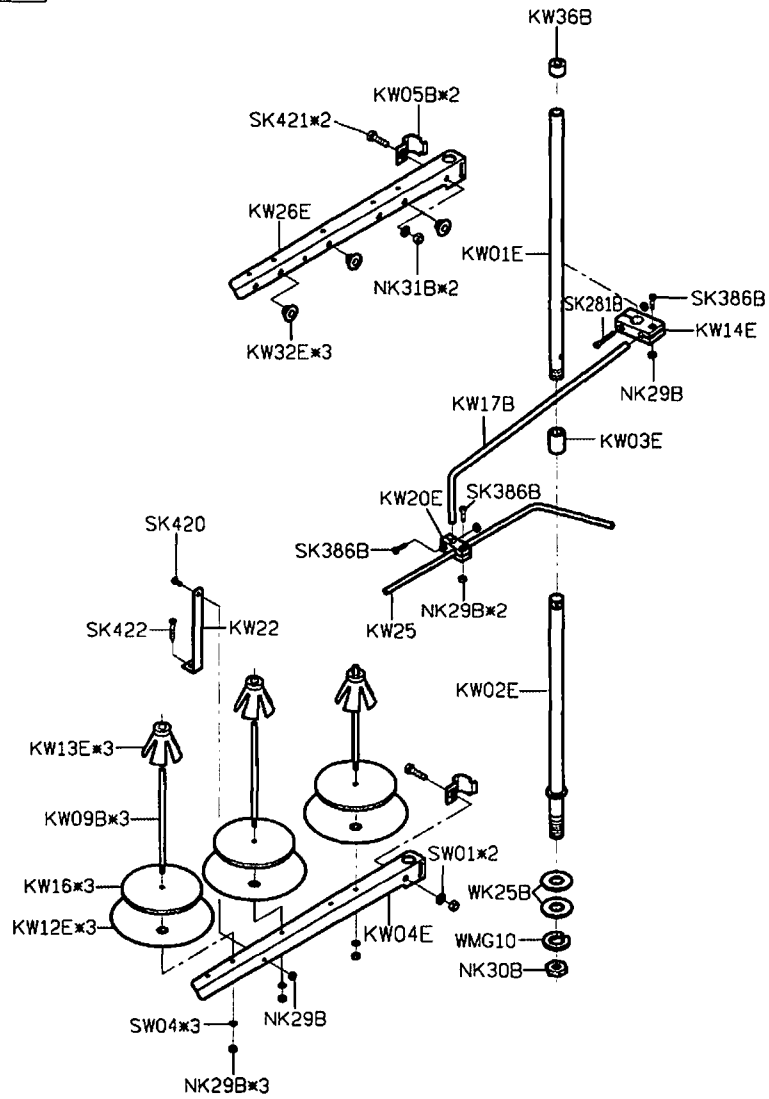

PARTS LIST FOR KW GROUP

KW40E-4

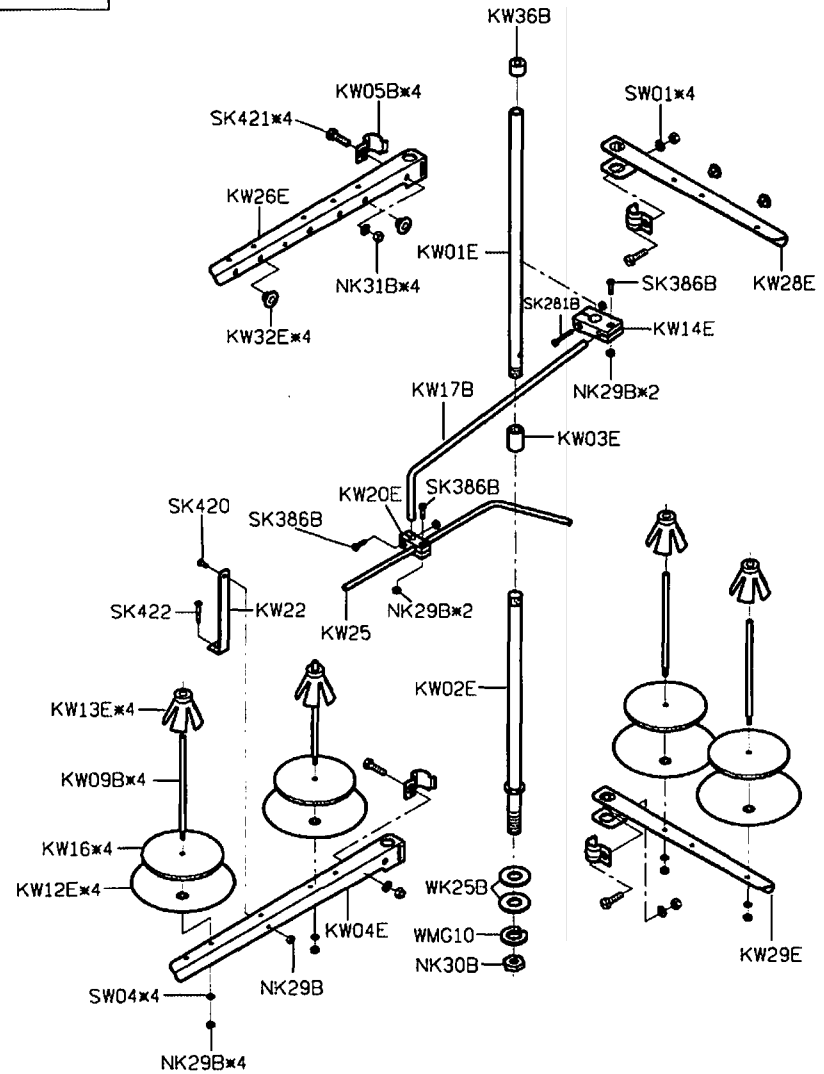





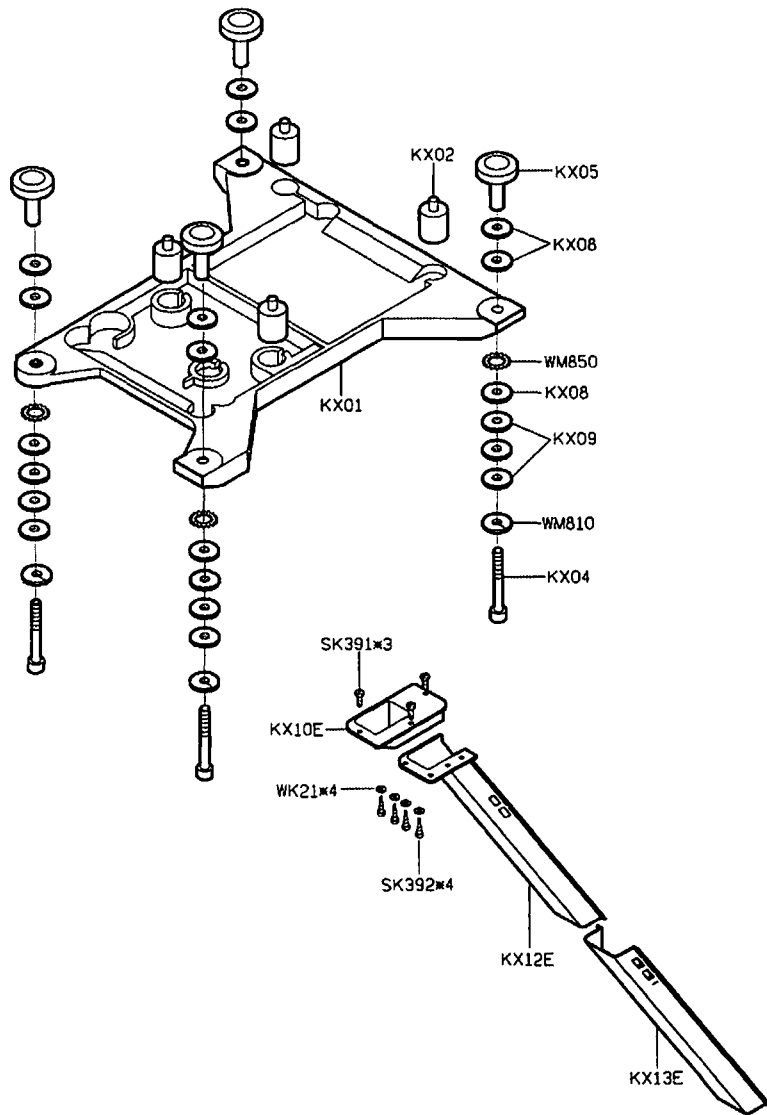



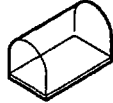
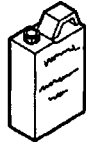















PARTS LIST FOR KW GROUP

PARTS LIST FOR KX GROUP



PARTS LIST FOR KY GROUP

KY01 防塵罩 	KY02-A 油罐 	KY03 油壺 	KY04S 漏斗 	KY05 油壺 
KY07 開口扳手 	KY08 開口扳手 	KY09 開口扳手 	KY10 六角扳手 	KY11 六角扳手 
KY12 六角扳手 	KY14 內六角螺絲起子 	KY16 一字起子 	KY17 一字起子 	KY18 鋸子 
KY20D 腳踏板 	KY21-A/MY21 鉤子/鍊條 	KY26F 工具袋 	KR55 下刀片 	KT14-A 濾油器 
針*4 	SK216*2 螺絲 	MY11 六角扳手 	KZ03 乾燥劑 	KZ13 使用說明書 

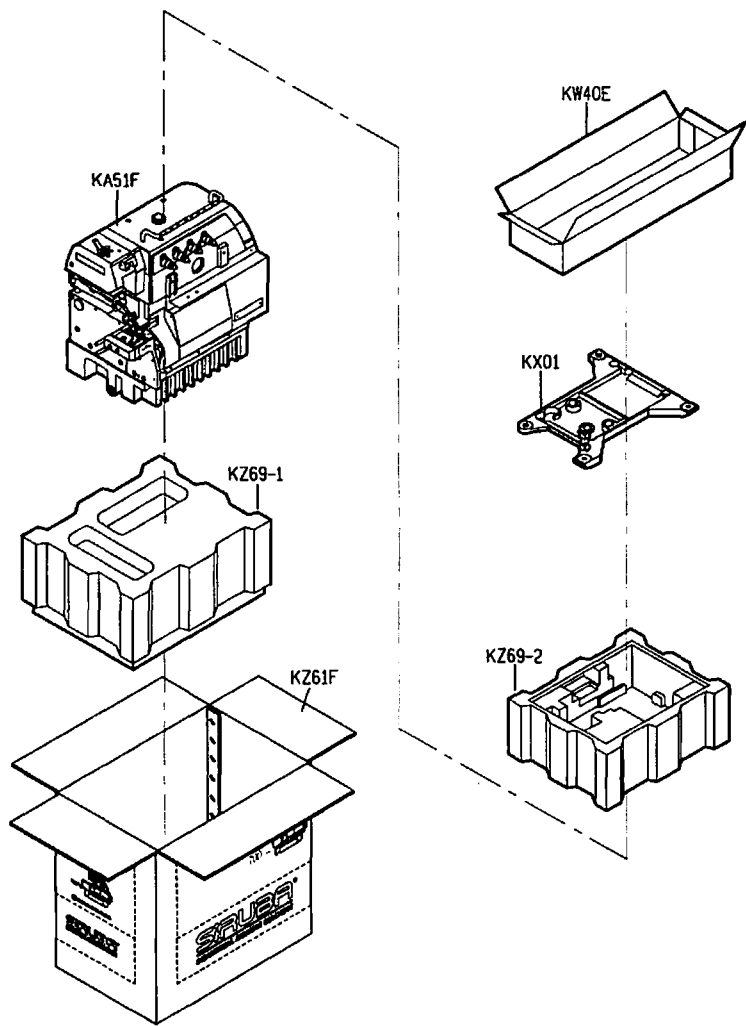

PARTS LIST FOR KZ GROUP



700FS

高林股份有限公司 KAULIN MFG. CO., LTD.

The specification and/or appearances of the equipment described in this parts list are subject to change because of modification without previous notice.

KZ08FS. SEP. 2005

From the library of: Superior Sewing Machine & Supply LLC