

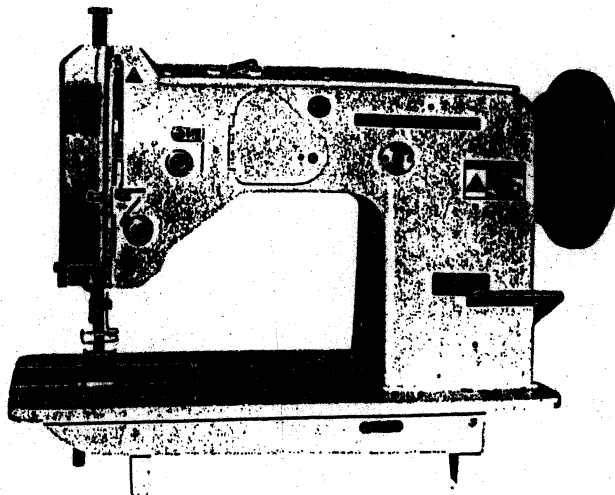









PARTS LIST FOR
SKZ-6 & SKZ-6B

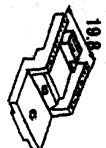
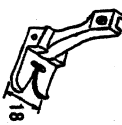

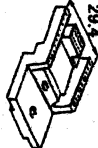
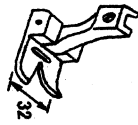
SEIKO SEWING MACHINE CO., LTD.
TOKYO • JAPAN

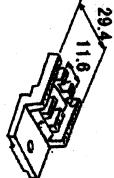
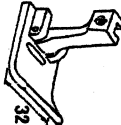
SKZ-6,6B

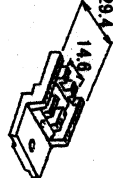
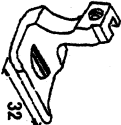
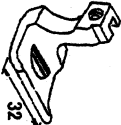
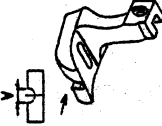
ゲージ部品一覧表/GAUGE PARTS LIST

	針板 THROTE PLATE	送り歯 FEED DOG	自由押え HINGED PRESSER FOOT				
3列 3 ROW	中狭 NARROW	 1878-A	 1981-A	 1867-AC			
	中広 WIDE	 1878	 1881	 1865C			
4列 4 ROW	6枚歯 中狭 6 TEETH NARROW	 1877	 1882	 1893-AC			
	6枚歯 中広 6 TEETH WIDE	 1876	 1890	 1894			
				 1894	 固定押え(素材) FIXING FOOT	 1893-BC	 1896
							1876Lに取付付可 SUITABLE FOR 1876

A (mm)	NO.
11.0	1885
8.2	1886
6.6	1887
5.2	1888
6.2	1889
9.4	1890
4.6	1891
7.2	1892

PBA-006(0702)

PAGE PLATE, ARM TOP COVER, KNEE LIFTER, LEVER

15007
Y Y Y Y Y

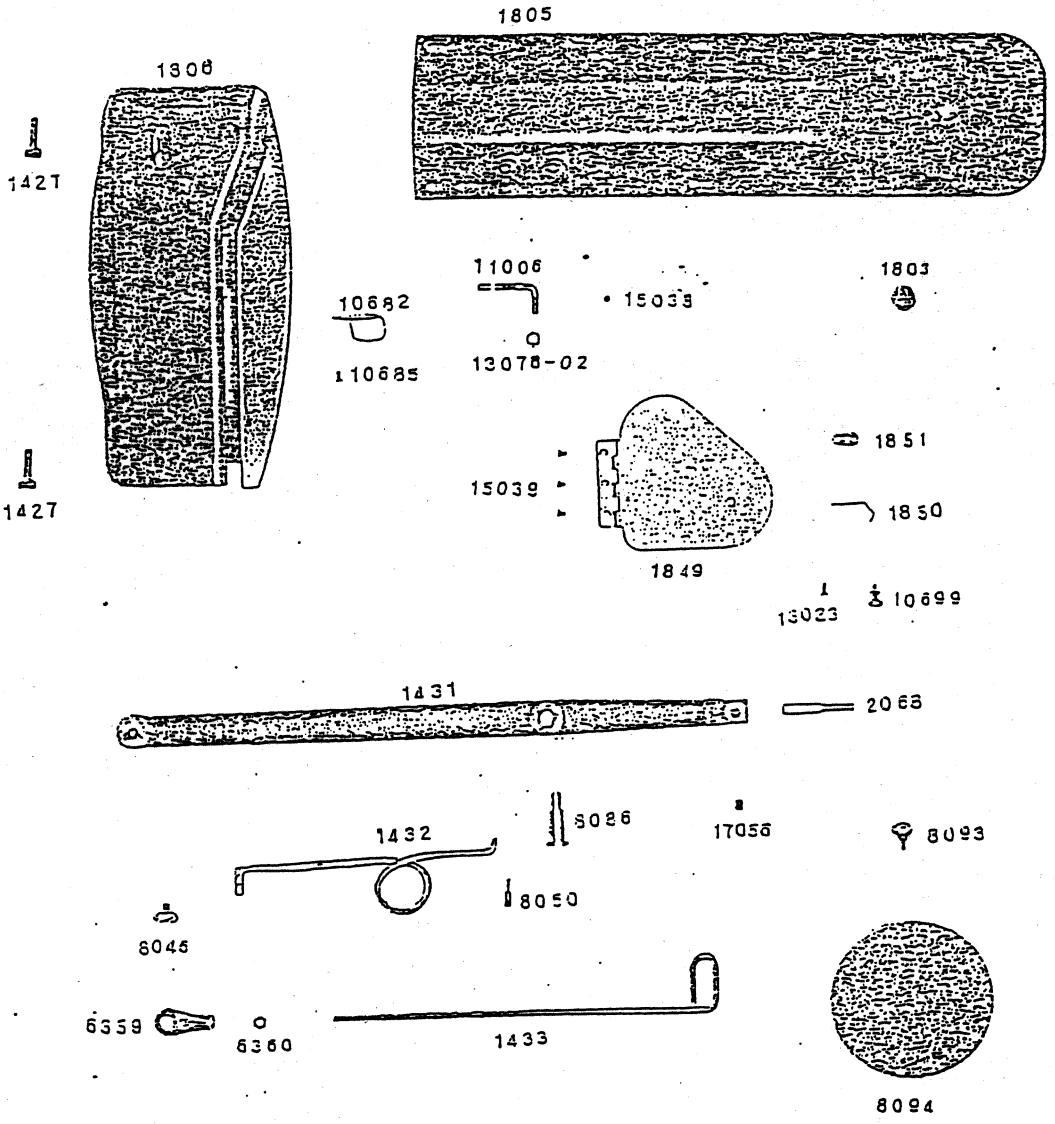

Y Y Y Y Y

10794

PROGGER BAR, NEEDLE BAR, TAKE UP LEVER, TENSION GROUP, TURRET GUIDE

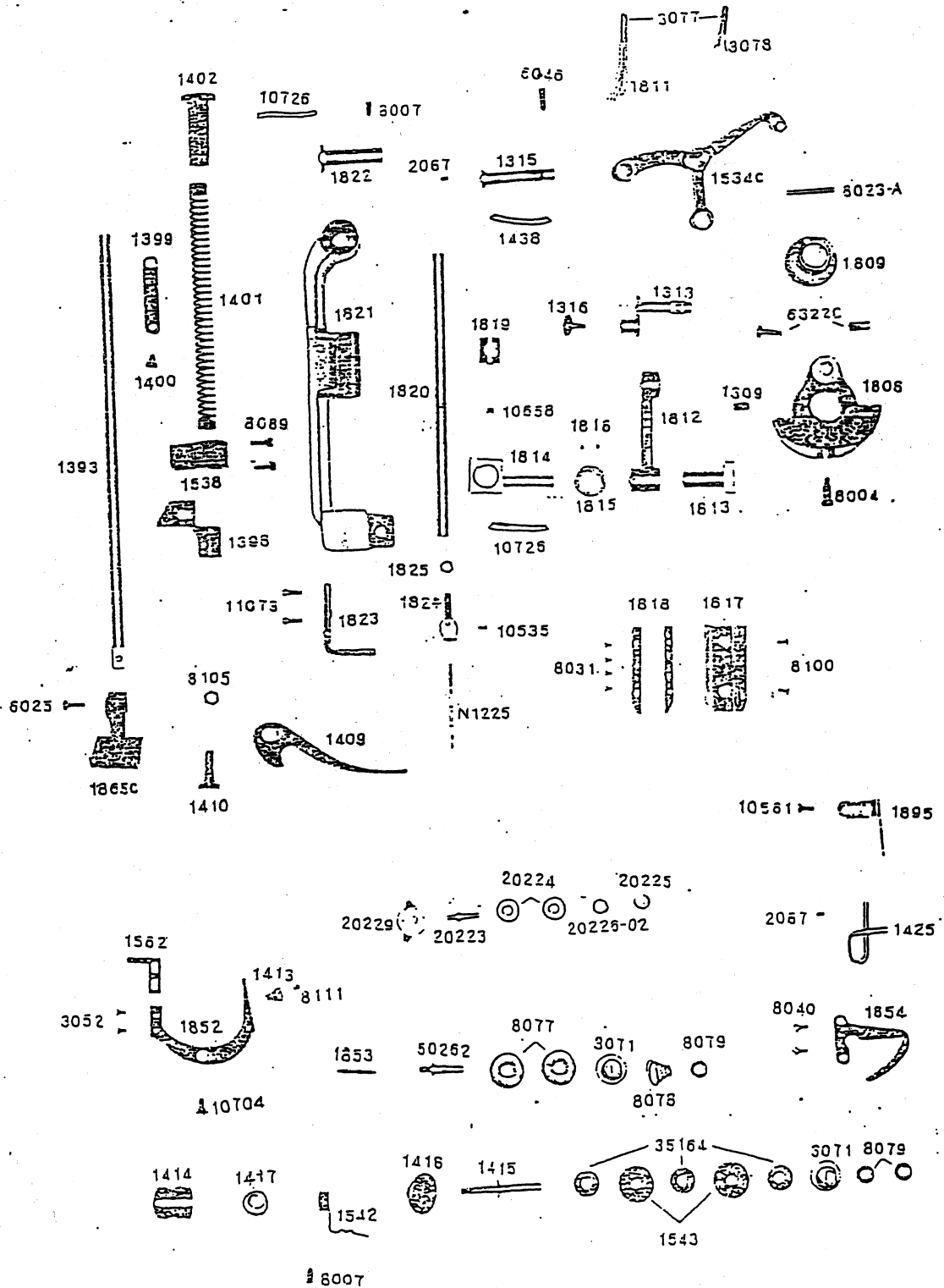

FEED MECHANISM, LOWER SECT., EGOR

Y Y-1860-Y Y

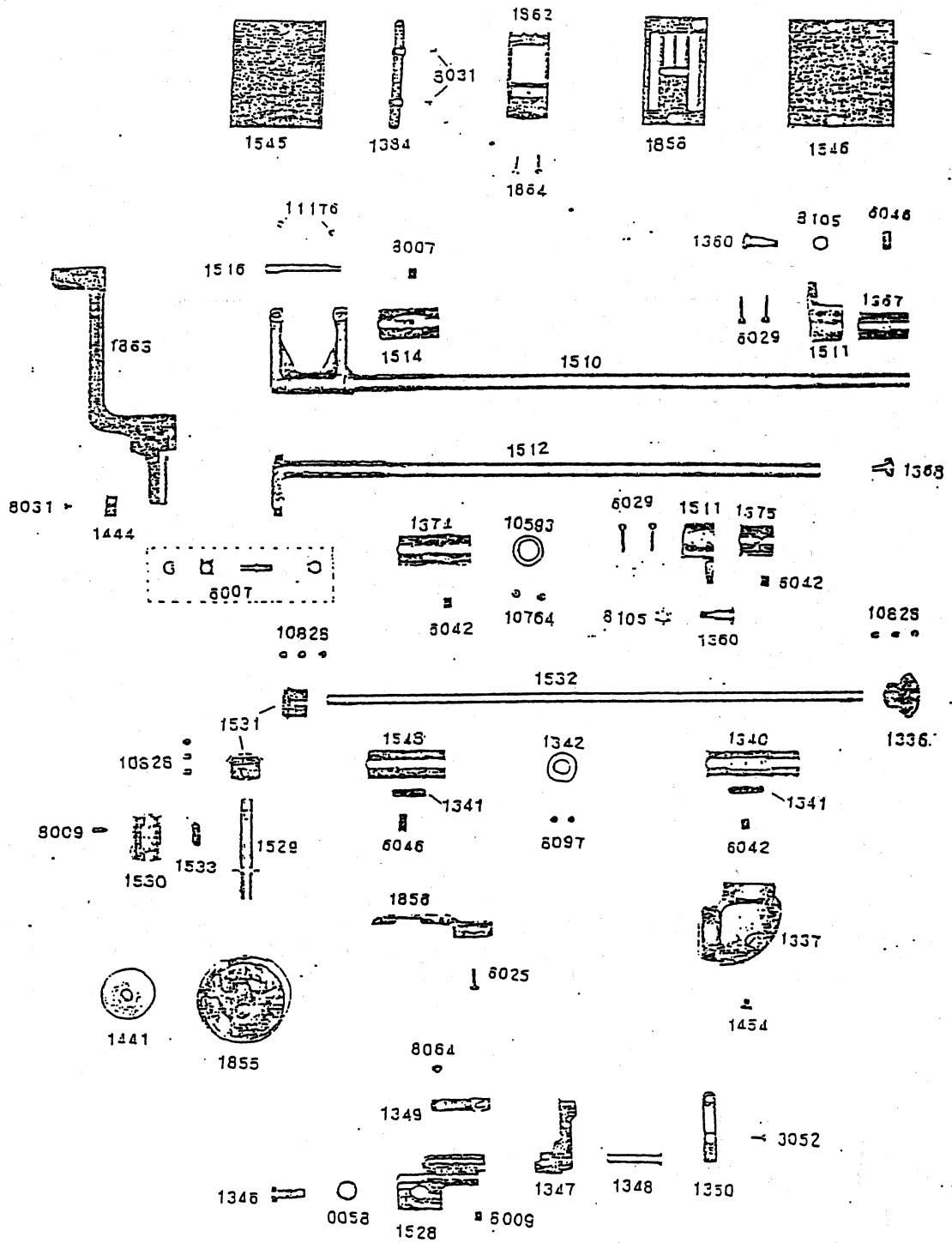

REVERSE FEEDING MACHANISM

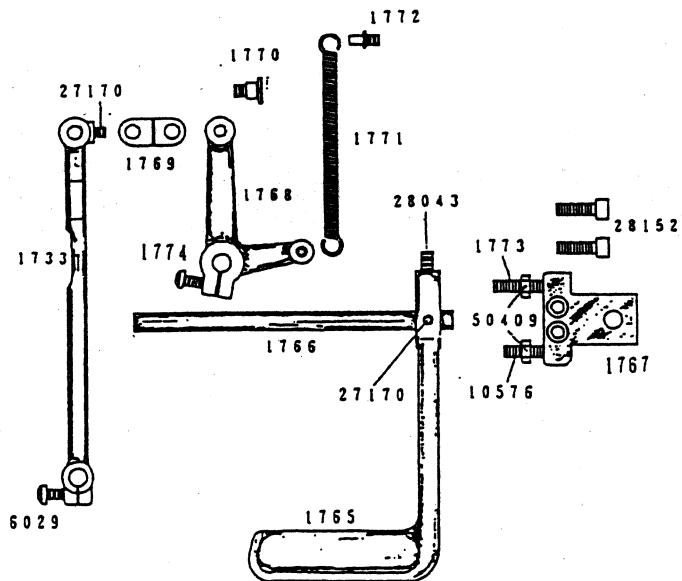
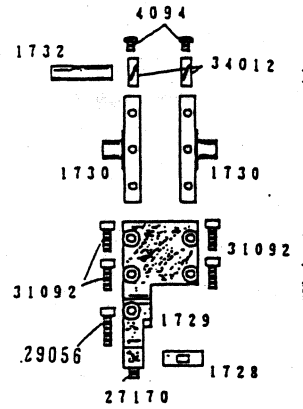
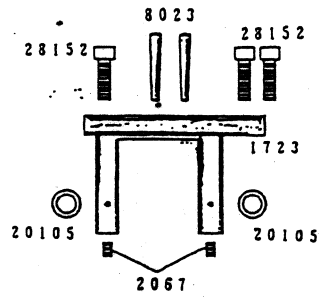

ZIGZAG MECHANISM. ARM SHAFT

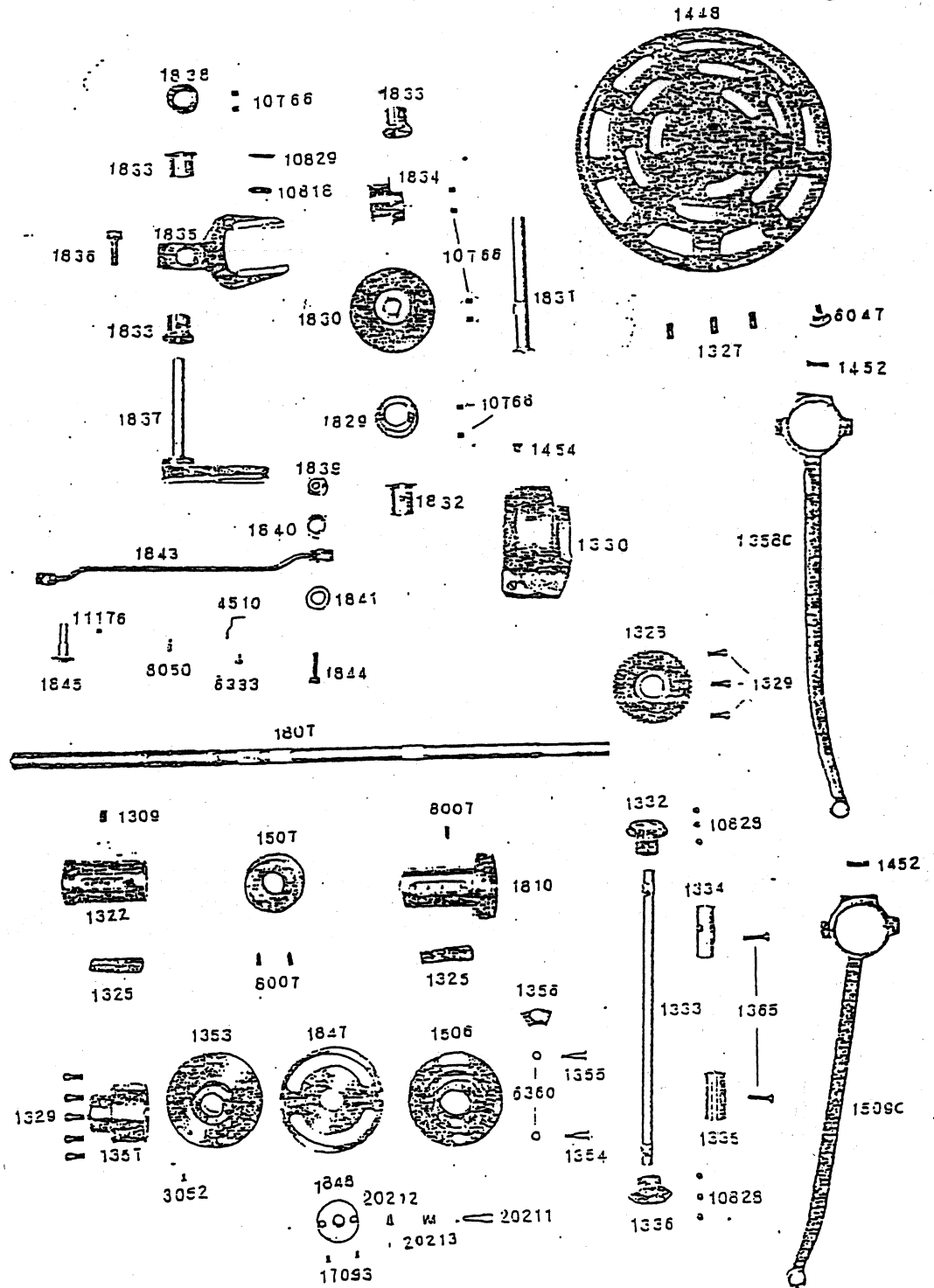

COTTON STAND. EYES LIFTER. OIL PAN

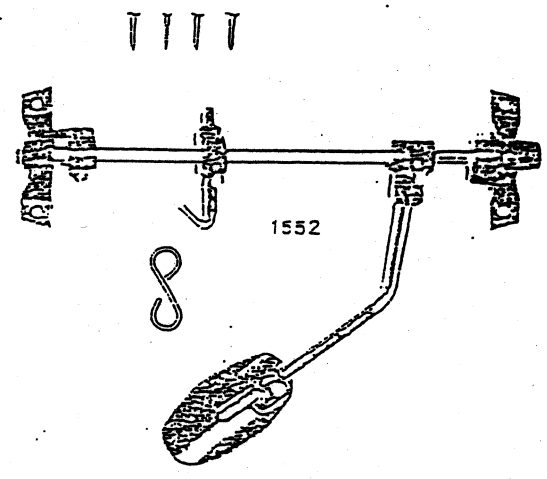
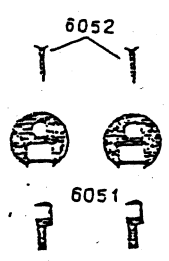
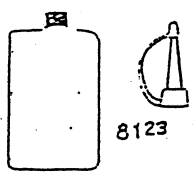
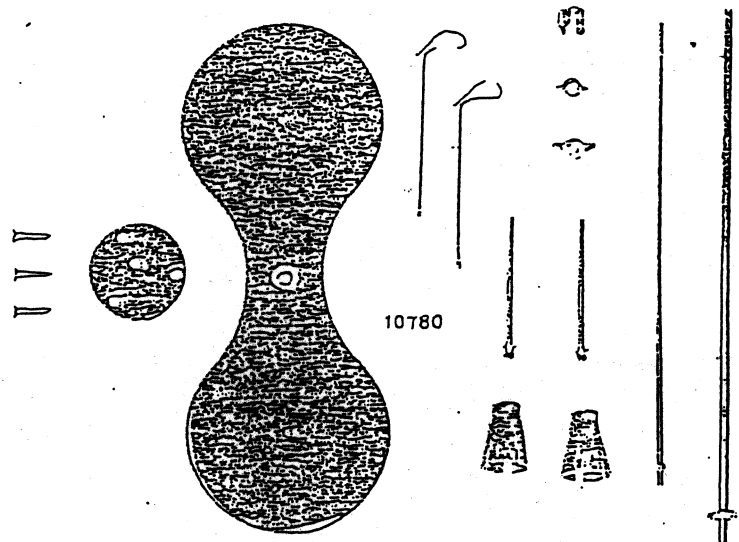

8-11176-2

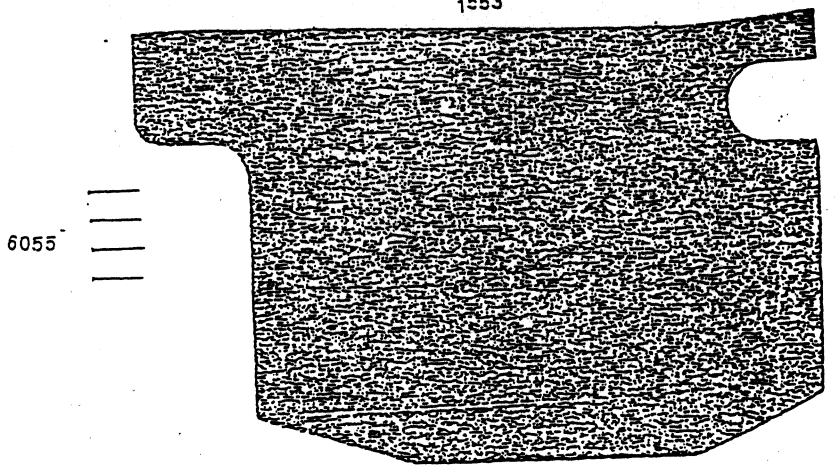

BELT GUARD - Optional Equipment

(set No. is 1875C)

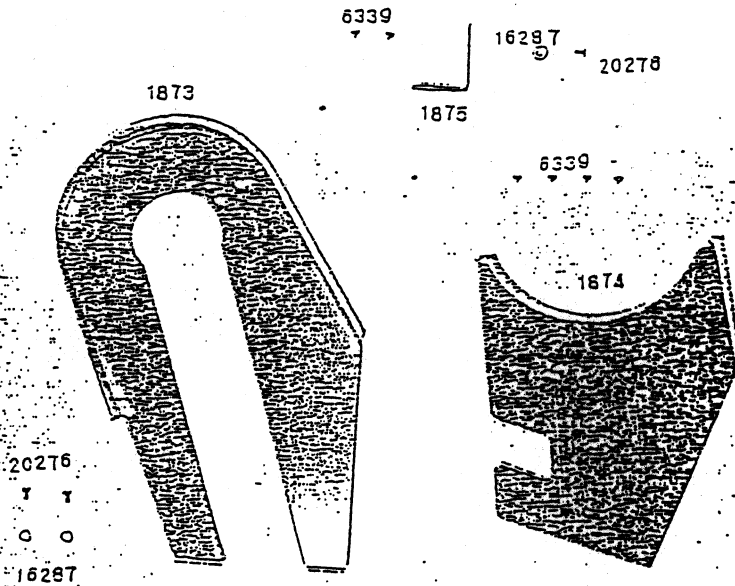

SOCK PARTS

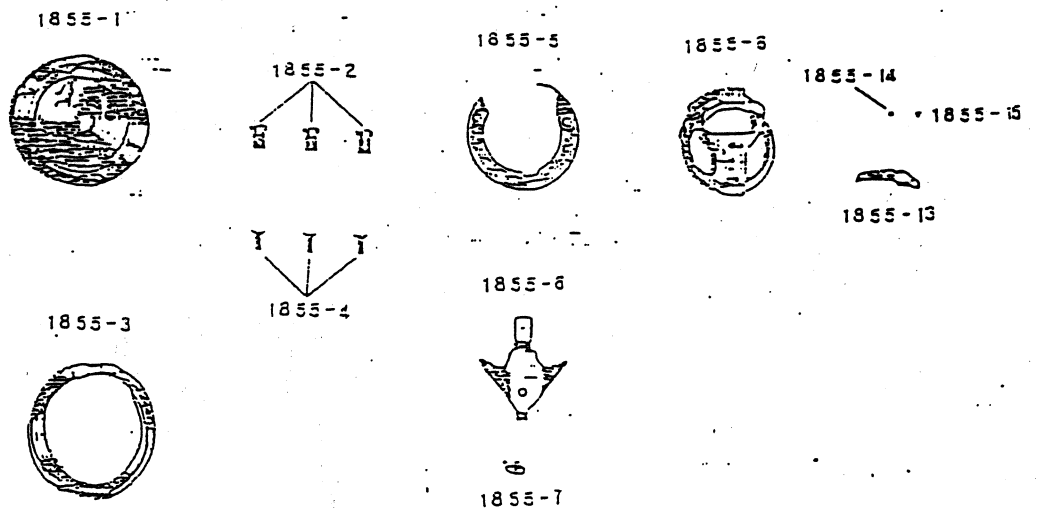

ACCESSORIES

8132

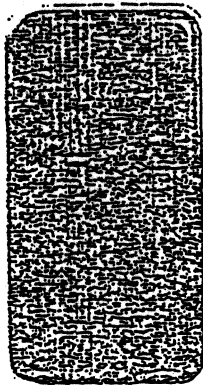

8124

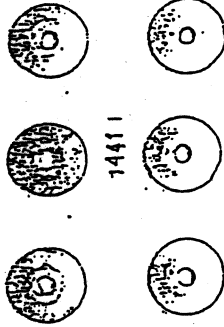

1441

1871

1870

1872

N1225

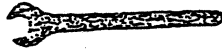
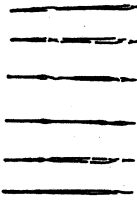

4202

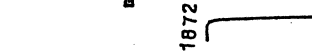
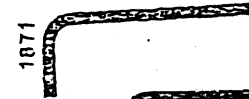

8120

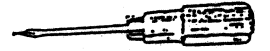

8121

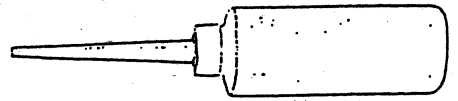

8125

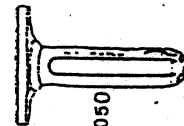

6050



7047

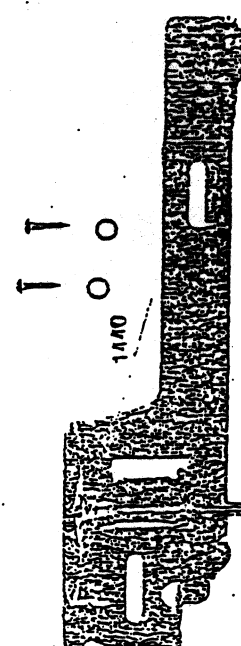

1440

SKZ-6-3

SPECIAL PARTS FOR SKZ-6-3 THREE
POINTS ZIGZAG STITCHING

