

627-00-1CD-01 627-01-1CD-03 627-29-1CD-05 627-00-2CD-44
627-00-1CD-02 627-01-1CD-04 627-30-1CD-07 627-00-2CD-45
627-00-1CD-06 627-01-1CD-05 627-34-1CD-01 627-00-2CD-47
627-00-1CD-07 627-01-1CD-09 627-34-1MD-03 627-00-2MD-02
627-00-1CD-09 627-01-1MD-08 627-38-1CD-01 627-00-2MD-20
627-00-1CD-20 627-10-1CD-06 627-49-1MD-01 627-00-2MD-21
627-00-1CD-21 627-22-1CD-01 627-49-1MD-03 627-00-2MD-36
627-00-1CD-25 627-22-1CD-02 627-00-2CD-13 627-01-2CD-05
627-00-1CD-26 627-23-1CD-01 627-00-2CD-15 627-01-2CD-06
627-00-1CD-29 627-23-1CD-02 627-00-2CD-16 627-01-2CD-20
627-00-1CD-30 627-28-1CD-02 627-00-2CD-17 627-01-2MD-07
627-00-1CD-31 627-28-1CD-07 627-00-2CD-18 627-01-2MD-11
627-00-1MD-23 627-28-1CD-09 627-00-2CD-31 627-22-2CD-06
627-00-1MD-33 627-28-1CD-12 627-00-2CD-32 627-22-2CD-31
627-01-1CD-02 627-29-1CD-02 627-00-2CD-41

EDIZIONE – EDITION 7 / 85 – 2ª

n. 327

ISTRUZIONI PER LA CONSULTAZIONE DEL CATALOGO

- Tutti i particolari delle teste sono rappresentati in più tavole come indicato nell'indice.
- I particolari sono esplosi nelle stesse posizioni in cui si trovano nelle teste.
- Le linee tratteggiate indicano i collegamenti tra i pezzi che per ragioni di disegno o di spazio non possono essere illustrati nello stesso asse.
- I simboli racchiusi da un riquadro (es. xxxxxx-x-xx) si riferiscono sempre a gruppi o sottogruppi.
- Nella rappresentazione grafica i componenti dei gruppi sono racchiusi da un riquadro; i componenti dei sottogruppi sono anch'essi riquadrati all'interno del gruppo.

TAVOLE CON PARTICOLARI COMUNI A TUTTE LE TESTE

- I simboli dei particolari o dei gruppi si leggono direttamente in corrispondenza dei pezzi.

TAVOLE CON PARTICOLARI NON COMUNI A TUTTE LE TESTE

- I simboli dei particolari o dei gruppi si leggono direttamente in corrispondenza dei pezzi.
- I particolari specifici per le singole teste sono indicati nel disegno con un numero progressivo evidenziato da un cerchio per i pezzi singoli o piccoli gruppi e da un quadrato per i gruppi principali. Per ricercare il simbolo del pezzo e del gruppo occorre consultare la relativa tabella riportata nella stessa tavola.

TAVOLE DOPPIE

- Per facilitare la consultazione alcune tavole sono state duplicate e sono indicate con lo stesso numero affiancato da una lettera (es. 3/A - 3/B).

ORGANI DI CUCITURA - GUIDE - ACCESSORI VARI

- Gli organi di cucitura - le guide - gli accessori vari sono preceduti da tavole riepilogative con l'indicazione dei particolari in dotazione e a richiesta.

AGHI

- Gli aghi sono contraddistinti dal sistema e dalla finezza. Il sistema dell'ago e la finezza sono marcati oltre che sulla busta, anche sull'ago stesso. Nelle ordinazioni precisare, oltre al simbolo, il sistema e la finezza degli aghi desiderati. In caso di dubbio allegare un ago campione o una busta vuota.

INSTRUCTION TO CONSULT THE CATALOGUE

- All the spare parts are illustrated in several tables as indicated in the index.
- The parts are illustrated as they belong together in the machine
- The dashed illustration shows where the adjacent parts belong
- The symbols included in a square (e.g. xxxxxx-x-xx) are always referred to assemblies or sub-assemblies.
- In the graphical representation the components belonging to sub-assemblies are also included in a square within their assembly.

TABLES WITH PARTS COMMON TO ALL HEADS

- The symbols of the parts or of the assemblies can be read in direct reference to the parts.

TABLE WITH PARTS NOT COMMON TO ALL HEADS

- The symbols of the parts or of the assemblies can be read in direct reference to the parts.
- In the drawing the specific parts for the single heads are indicated by a progressive figure which is made evident by a circle for the single parts or small assemblies and by a square for the main assemblies. The symbol of the part or of the assembly can be located by consulting the relevant part-list included in the same table.

DOUBLE TABLES

- For easier reference, some tables have been duplicated. They are indicated by the same figure plus an additional letter, (e.g. 3/A and 3/B)

SEWING PARTS - FOLDERS - VARIOUS ACCESSORIES

- Sewing parts, folders and various accessories are preceded by summary tables indicating standard parts supplied and parts supplied on request.

NEEDLE

- The needles are marked with system and size. The system and size of the needle are shown on the packet as well as on the needle itself. When ordering please state symbol, system and size. If you have doubts, enclose a sample needle or an empty packet with your order.

INSTRUCTION POUR LA CONSULTATION DU CATALOGUE

- Toutes les pièces des têtes sont représentées en plusieurs table comme nous avons indiqué dans l'index.
- Les pièces figurent sur l'illustration comme elles vont ensemble
- Les figures en tirets montrent le lieu de montage des pièces figurant à côté.
- Les symboles compris entre panneaux (ex. xxxxxx-x-xx) se réfèrent toujours à des groupes ou sous-groupes.
- Dans la représentation graphique les composants des sous-groupes sont eux-mêmes encadrés à l'intérieur du groupe.

TABLES AVEC COMPOSANTS COMMUNS A TOUTES LES TETES

- Les symboles des composants et des groupes se lisent directement en correspondance des pièces.

TABLES AVEC COMPOSANTS NON COMMUNS A TOUTES LES TETES

- Les symboles des composants et des groupes se lisent directement en correspondance des pièces.
- Les composants spécifiques de chaque tête sont indiqués sur les dessins avec un numéro progressif encerclé pour les simples composants ou petits groupes et numéro encadré pour les groupes principaux. Pour chercher le symbole de la pièce ou du groupe il faut consulter la relative fiche reportée sur la même table.

TABLE DOUBLE

- Pour faciliter la consultation certaines tables ont été doublées et sont indiquées avec le même numéro suivi par une lettre (ex. 3/A - 3/B)

ORGANES DE COUTURES - GUIDES - ACCESSOIRES DIVERS

- Les organes de coutures - les guides - les divers accessoires sont précédés de tables résumés avec l'indication des composants en dotation et sur demande.

AIGUILLES

- Les aiguilles se différencient par le système et la grosseur. Le système de l'aiguille et sa grosseur, sont indiqués non seulement sur le sachet mais également sur l'aiguille. Dans l'ordre précisé, en plus du symbole, le système et la grosseur des aiguilles désirés. En cas de doute, joindre une aiguille comme modèle ou un sachet vide.

TAV. N. TAB. N.	* DESCRIZIONE	DESCRIPTION	DESCRIPTION	Testa 1 ago Head 1 needle Tete 1 aiguille	Testa 2 aghi Head 2 needles Tete 2 aiguilles
1	CARTER E PIANO DI LAVORO	CARTER AND WORKING PLATE	CARTER ET PLAN DE TRAVAIL	●	●
2	COPERCHIO CON TENSIONI E PASSAFILI	COVER WITH TENS. AND THREAD GUIDE	COUVERCLE AVEC TENS. ET PASSE FILS	●	
2A	COPERCHIO CON TENSIONI E PASSAFILI	COVER WITH TENS. AND THREAD GUIDE	COUVERCLE AVEC TENS. ET PASSE FILS		●
3	ALBERO PRINCIPALE	MAIN SHAFT	ARBRE PRINCIPAL	●	●
4 - 4A	COMANDO GRIFFA	FEED DOG CONTROL	COMMANDE GRIFFE	●	●
5	PORTA CROCHETS	LOWER LOOPERS	PORTE CROCHETS	●	●
6	SUPPORTO PORTA CROCHETS	LOWER LOOPERS SUPPORT	SUPPORT PORTE CROCHETS	●	●
7	CINEMATISMO BARRA AGO	NEEDLE BAR CONTROL	CINEMATISME BARRE AIGUILLE	●	●
7A	MORSETTI AGO	NEEDLE CLAMPS	COLLIER POUR AIGUILLES	●	●
7B	AGHI	NEEDLES	AIGUILLES	●	●
8	SUPPORTO E LEVA PREMISTOFFA	SUPPORT AND PRESSER LEVER	SUPPORT ET LEVIER PRESSE-TISSUE	●	●
9	PORTA COLTELLI E SALVA AGO	KNIVESHOLDER & REAR NEEDLE GUARD	PORTE COUTEAUX ET PROTEGE AIGUILLES	●	●
10	POMPA OLIO E LUBRIFICAZIONE	OIL PUMP AND LUBRICATION	POMPE A HUILE ET LUBRIFICATION	●	●
11	BACINELLA OLIO	OIL SUMP	RESERVOIR HUILE	●	●
12	ACCESSORI IN DOTAZIONE	AUXILIARY EQUIPMENT	ACCESSOIRES EN DOTATION	●	●
13	PIAZZAMENTO NORMALE	NORMAL SETTING	PLACEMENT NORMAL	●	●
14	PIAZZAMENTO INCASSATO	SUBMERGED SETTING	PLACEMENT ENCASTRE	●	●
15	PORTA BOBINE	BOBBIN CARRIER	PORTE BOBINE	●	●
16	PORTA BOBINE (627-01-1CD-20)	BOBBIN CARRIER (627-01-1CD-20)	PORTE BOBINE (627-01-1CD-20)	●	
17 ÷ 23	RIEPILOGO ORGANI DI CUCITURA	SEWING PARTS SUMMING UP	RECAPITOLATION ORGANES DE COUTURE	●	
24 - 25	PLACCHE	PLATES	PLAQUES	●	
26 ÷ 29	GRIFFE	FEED DOGS	GRIFFES	●	
30 ÷ 35	PIEDINI	PRESSER FEET	PIED PRESSEURS	●	
36 ÷ 38	COLTELLI	KNIVES	COUTEAUX	●	
38	CROCHETS	LOOPERS	CROCHETS	●	
39 ÷ 42	RIEPILOGO ORGANI DI CUCITURA	SEWING PARTS SUMMING UP	RECAPITOLATION ORGANES DE COUTURE		●
43 - 44	PLACCHE	PLATES	PLAQUES		●
45 - 46	GRIFFE	FEED DOGS	GRIFFES		●
47 - 48	PIEDINI	PRESSER FEET	PIED PRESSEURS		●
49 ÷ 51	COLTELLI	KNIVES	COUTEAUX		●
51	CROCHETS	LOOPERS	CROCHETS		●
52 ÷ 55	RIEPILOGO GUIDE - GINOCCHIELLI - PORTA ROTOLI	GUIDE - KNEEPRESS - ROLL CARRIER - SUMMING UP	RECAPITOLATION GUIDE - GENOUILLERE - PORTE ROULEAUX	●	●
56 ÷ 64	GUIDE - GINOCCHIELLI - PORTA ROTOLI	GUIDE - KNEEPRESS - ROLL CARRIER	GUIDE - GENOUILLERE - PORTE ROULEAUX	●	●

INDICE NUMERICO				INDEX				INDICE NUMERICO				INDEX			
N	Tav. N.	Part. N	Tav. N.	Part. N	Tav. N.	Part. N	Tav. N.	Part. N	Tav. N.	Part. N	Tav. N.	Part. N	Tav. N.		
100527-0-10	2	203142-0-10	8	206659-2-02	5	207541-0-00	7A	208569-4-00	7A	209179-0-00	3	209390-0-00	4		
100528-0-10	2	203380-0-10	9	206665-2-00	11	207542-0-00	7A	209013-0-00	11	209185-0-00	3	209392-3-00	4		
100529-0-10	2	203381-0-10	2	206680-0-01	3	207563-0-00	7A	209015-0-00	2 2A	209200-0-00	4	209393-0-00	4A		
100620-2-10	4	203389-2-10	2	206681-0-00	3	207574-0-00	7	209016-0-00	2 2A	209201-0-00	4	209400-0-00	4		
100892-0-10	4A	203390-4-10	2	206687-2-00	10	207586-0-00	9	209017-0-00	2 2A	209203-2-00	6	209401-2-00	4		
200356-0-10	1	203392-2-10	2	206688-0-00	10	207588-0-00	9	209018-0-00	2 2A	209204-2-00	6	209402-0-00	4		
200662-0-10	9	203393-4-10	2	206689-0-01	3	207625-0-00	8	209020-0-00	1	209205-2-00	6	209403-2-00	4		
200821-0-10	2	203394-0-10	2	206690-2-00	10	207626-0-00	8	209022-0-00	2 2A	209206-0-00	6	209404-0-00	4		
201009-0-10	2	203395-4-10	2	206692-0-00	3	207653-0-01	9	209041-0-00	11	209209-0-00	5 6	209405-0-00	4		
201128-0-10	5 6	203396-0-10	2	206693-0-00	3	207692-2-00	7	209045-0-00	1	209210-0-00	6	209408-2-00	4		
202032-0-11	4	203415-0-20	7A	206713-2-00	2A	207719-0-00	4	209048-3-00	11	209217-0-00	6	209412-0-00	1		
202128-0-10	9	203416-0-10	7A	206714-2-00	2 2A	207730-2-02	6	209080-3-00	7	209218-2-00	6	209413-0-00	1		
202129-0-10	9	203525-0-11	9	206740-0-00	2 2A	207871-0-00	2A	209100-2-00	3	209222-0-00	6	209414-0-00	10		
202130-0-11	9	203572-0-10	2A	206747-0-01	2 2A	207893-0-00	2 2A	209103-2-00	3	209224-0-00	6	209415-0-00	1		
202134-0-11	9	203810-0-10	9	206752-0-00	13 14	207895-0-01	2 2A	209104-0-00	3	209225-0-00	6	209416-0-00	1		
202194-0-11	8	204122-0-10	3	206754-0-00	2 2A	207927-0-01	7	209105-2-00	7	209226-0-00	6	209417-0-00	1		
202214-0-11	8	204757-0-11	3	206757-0-00	9	207930-0-10	7	209108-0-00	7	209234-3-00	6	209427-3-00	4A		
202227-0-10	2 2A	204947-0-10	8	206758-0-00	9	207932-0-10	7	209109-0-00	3	209239-2-00	6	209442-0-00	4A		
202228-0-10	2	205021-0-10	8	206771-0-12	8	207948-0-00	4A	209110-4-00	3	209241-3-00	6	209443-0-00	4A		
202229-0-10	2 2A	205191-0-10	9	206794-0-00	4	207959-0-00	8	209111-0-00	3	209243-0-00	2 2A	209444-0-00	4A		
202278-0-10	2A	206521-0-00	7	206795-0-00	4	207960-0-00	8	209121-0-00	7	209250-2-00	5	209445-2-00	4A		
202371-0-10	8	206533-0-00	7	206796-0-00	4	207962-0-00	8	209125-0-00	3	209252-0-00	5	209448-4-00	4A		
202384-0-10	4	206543-0-01	3	206798-0-00	4	207973-0-01	10	209126-0-00	3	209258-0-00	5	209449-0-00	4A		
202385-0-10	4	206550-4-04	10	206810-2-00	8	207980-0-00	1	209140-2-00	7	209261-0-00	5	209455-3-00	4		
202386-0-10	3	206554-0-10	10	206860-0-00	3	207990-0-00	9	209141-2-00	7	209270-2-00	5 6	209459-0-00	4A		
202387-0-10	3	206555-0-02	10	206875-0-00	4	207991-0-00	9	209142-2-00	7	209272-0-00	5 6	209500-0-00	10		
202389-0-10	3	206556-0-01	3	206893-0-00	2	207992-0-01	9	209143-0-00	7	209277-2-00	5	209501-0-00	8		
202391-0-11	8	206557-0-00	10	206896-0-00	2	207993-0-01	9	209144-2-00	3	209316-0-00	10	209502-2-01	8		
202397-0-10	2	206564-0-00	11	207111-0-00	9	207994-0-01	9	209146-0-00	3	209375-0-00	4A	209503-0-00	8		
202398-0-10	1	206603-0-10	4A 7	207417-0-00	9	207995-0-00	9	209151-3-00	7	209376-0-00	4A	209504-0-00	8		
202408-0-10	4A	206606-0-00	4 5 6	207421-0-01	9	207996-0-00	9	209152-4-00	7	209377-0-00	4A	209510-0-00	8		
202484-0-10	10	206607-0-00	7	207510-4-00	7A	207997-0-00	9	209153-0-00	7	209378-0-00	4A	209511-0-00	8		
202490-0-10	4	206622-0-00	8	207511-4-00	7A	207998-2-00	9	209159-0-00	2A	209379-0-00	4A	209514-0-00	8		
202529-0-10	8	206635-0-00	8	207512-4-00	7A	207999-0-00	9	209161-0-00	7	209380-0-00	4A	209516-0-00	8		
202556-0-01	2 2A	206637-0-00	8	207513-4-00	7A	208015-0-00	5	209162-0-00	7	209381-0-00	4A	209517-0-00	8		
2 2558-2-01	2 2A	206641-2-10	8	207520-2-00	7A	208169-0-00	2A	209170-0-00	2 2A	209383-0-00	10	209518-0-00	8		
2 2620-0-10	9	206642-0-00	8	207521-2-10	7A	208220-0-00	2 2A	209171-0-00	2 2A	209384-0-00	4A	209524-2-00	8		
202629-0-10	9	206648-2-02	6	207522-2-00	7A	208336-2-00	8	209173-0-00	2 2A	209386-0-01	4A	209561-0-00	9		
202681-0-10	2 2A	206649-2-02	6	207523-2-00	7A	208521-2-00	7A	209177-0-00	7A	209387-2-00	4	209569-2-00	9		
203135-2-10	2 2A	206658-2-02	5 6	207540-0-00	7A	208566-0-00	9	209178-2-00	3	209388-0-00	4	209570-0-00	9		

INDICE NUMERICO		INDEX		INDICE NUMERICO		INDEX	
Part. N.	Tav. N.	Part. N.	Tav. N.	Part. N.	Tav. N.	Part. N.	Tav. N.
209580-2-00	9	209723-0-00	1	703802-0-00	4A	722063-2-00	1 3 10
209581-2-00	9	209724-0-00	1	704004-0-00	8	722103-0-00	1
209582-2-00	9	209753-0-00	2 2A	704013-2-00	13 14	722123-2-00	8
209583-0-00	7 9	209760-0-00	2 2A	704017-2-11	15 16	722143-2-00	1
209584-0-00	7	209767-0-00	2 2A	704213-2-00	7 8 9	722400-2-00	2 2A
209586-0-00	9	209770-0-00	2A	704236-2-00	3	722431-2-00	15 16
209587-0-00	9	209771-0-00	2 2A	704306-0-00	4	722432-2-00	4
209588-0-00	9	209772-0-00	2 2A	704314-2-00	4A	722442-2-00	4
209589-2-00	9	209774-0-00	5	704346-2-00	13 14	722461-2-00	3
209590-0-00	9	209775-0-00	2 2A	704406-0-00	9	722471-2-00	9
209621-3-00	10	209778-0-00	2A	704409-0-00	4A 9 14	722480-2-00	9
209624-0-00	11	209779-0-00	2	704424-2-00	13 14	722511-2-00	10
209627-0-00	10	209780-0-00	2	704630-0-00	2 2A	722912-2-00	13 14
209628-0-00	10	209781-4-00	2	704717-0-00	2 2A	722920-2-00	13 14
209633-0-00	10	209785-0-00	2 2A	704813-0-00	10	724032-0-00	4
209634-0-00	10	300218-0-10	2 2A	704829-0-00	4	724430-2-00	4A
209640-0-00	10	300429-2-10	2	704840-0-00	6	724460-0-00	7
209641-0-00	10	300482-0-10	9	704841-0-00	4 5 6	724472-2-00	2 2A
209642-0-00	6	300827-0-10	2 2A	704845-0-00	5 6	725032-0-00	1
209644-0-00	11	309562-0-00	7	704847-0-00	5 6	727014-2-00	7
209645-0-00	11	309749-0-00	7A	704848-0-00	5 6	727021-0-00	7A
209646-0-00	11	310167-0-00	7	704860-0-00	4	727036-2-00	5 6
209647-4-00	11	310795-0-00	4A	704863-0-00	7 9	728232-0-00	4A
209678-0-00	10	350555-0-00	4A	705208-0-00	4	729012-2-00	1 4A 6 7
209679-0-00	10	700010-0-00	4	705970-0-00	10	729022-2-00	10
209680-0-00	1	700205-0-00	2 13 14	705977-0-00	11	729023-2-00	4A
209681-0-00	1	700206-0-00	4	720411-2-00	11	729031-2-00	7 8
209682-0-00	1	700207-0-00	4 4A	720431-2-00	2 2A	729032-2-00	4A
209683-0-00	1	700630-0-00	3	720546-0-00	13 14	729033-2-00	4A
209684-0-00	1	701004-0-00	4A 10	721086-2-00	2 2A	729034-2-00	3 7 15
209686-0-00	1	701005-0-00	11	721411-2-00	7A	745002-0-00	2 2A 7
209688-0-00	1	701006-0-00	4A	721412-2-00	2 2A	745421-0-00	7
209690-0-00	1	701007-0-00	4	721434-2-00	11	745501-0-00	7A
209693-0-00	4	701009-0-00	7	721443-2-00	9	745800-2-00	2 2A 5 7
209704-0-00	1	701011-0-00	5	721454-2-00	1 3	745810-2-00	6 7A
209705-0-00	3	701031-0-00	10	721473-2-00	3	745812-2-00	1 3 4 4A
209710-0-00	1	701116-0-00	3	721474-2-00	1	745815-2-00	3 4A
209714-0-00	1	701125-0-00	6	721475-2-00	14	746007-2-00	8
209717-0-00	1	701133-0-00	3	721484-2-00	10	746022-2-00	2
209719-0-00	1	703005-0-00	15 16	721515-2-00	6	746204-2-00	8
209720-0-00	1	703405-0-00	1	721883-0-00	5	746402-2-00	13 14
						740087-2-00	4A
						746409-2-00	13 14
						765200-1-10	7B
						765200-1-60	7B
						765200-1-70	7B
						765200-1-80	7B
						765200-1-90	7B
						765400-1-60	7B
						765400-1-80	7B
						765400-1-90	7B
						778202-0-00	6
						778204-0-00	7
						778206-0-00	7A
						778208-0-00	7
						778403-0-00	6
						778414-0-00	7
						778417-0-00	7
						778419-0-00	7
						778503-0-00	7
						778511-0-00	7
						778833-0-00	7
						778842-0-00	7
						790705-0-00	10
						790719-0-00	10
						900203-0-10	13 14
						900204-0-10	13 14
						900694-0-11	13 14
						901101-0-00	13 14
						901102-0-00	13 14
						901151-0-00	13 14
						901152-0-00	13 14
						901153-0-00	13 14
						920499-0-00	2 2A
						925433-0-00	15 16
						926273-0-00	8
						944445-0-00	10
						990176-0-10	12
						990179-4-11	13 14
						990183-0-13	12
						990310-0-10	13 14
						990311-0-10	13 14
						990312-0-10	13 14
						990314-0-10	13 14
						M488972020	13

TAV. 1

①

627-00-1CD-01	209714-0-00
627-00-1CD-02	209714-0-00
627-00-1CD-06	209714-0-00
627-00-1CD-07	209714-0-00
627-00-1CD-09	209714-0-00
627-00-1CD-20	209714-0-00
627-00-1CD-21	209714-0-00
627-00-1CD-25	209714-0-00
627-00-1CD-26	209714-0-00
627-00-1CD-29	209714-0-00
627-00-1CD-30	209714-0-00
627-00-1CD-31	209714-0-00
627-00-1MD-23	209714-0-00
627-00-1MD-33	209714-0-00
627-01-1CD-02	209714-0-00
627-01-1CD-03	209714-0-00
627-01-1CD-04	209714-0-00
627-01-1CD-05	209714-0-00
627-01-1CD-09	209714-0-00
627-01-1MD-08	209714-0-00
627-10-1CD-06	209714-0-00
627-22-1CD-01	209714-0-00
627-22-1CD-02	209714-0-00
627-23-1CD-01	209714-0-00
627-23-1CD-02	209714-0-00
627-28-1CD-02	209714-0-00
627-28-1CD-07	209714-0-00
627-28-1CD-09	209714-0-00
627-28-1CD-12	209714-0-00
627-29-1CD-02	209714-0-00
627-29-1CD-05	209714-0-00
627-30-1CD-07	209714-0-00
627-34-1CD-01	209714-0-00
627-34-1MD-03	209714-0-00
627-38-1CD-01	209714-0-00
627-49-1MD-01	209714-0-00
627-49-1MD-03	209714-0-00
627-00-2CD-13	209714-0-00
627-00-2CD-15	209714-0-00
627-00-2CD-16	209714-0-00
627-00-2CD-17	209714-0-00
627-00-2CD-18	209714-0-00
627-00-2CD-31	209714-0-00
627-00-2CD-32	209714-0-00
627-00-2CD-41	209714-0-00
627-00-2CD-44	209714-0-00
627-00-2CD-45	209714-0-00
627-00-2CD-47	209714-0-00
627-00-2MD-02	209717-0-00
627-00-2MD-20	209714-0-00
627-00-2MD-21	209714-0-00
627-00-2MD-38	209714-0-00
627-01-2CD-05	209714-0-00
627-01-2CD-06	209714-0-00
627-01-2CD-20	209714-0-00
627-01-2MD-07	209717-0-00
627-01-2MD-11	209714-0-00
627-22-2CD-06	209714-0-00
627-22-2CD-31	209714-0-00

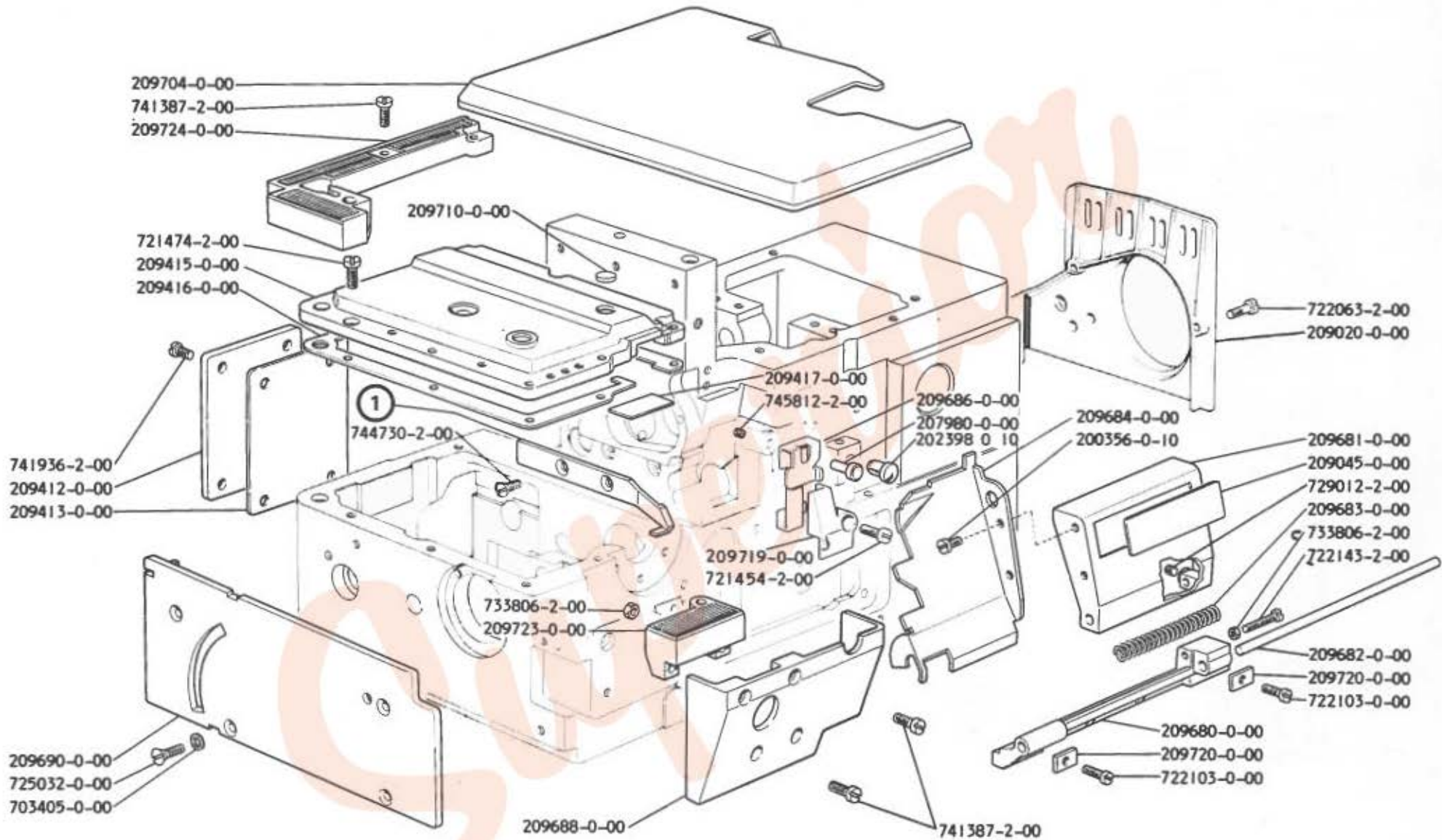

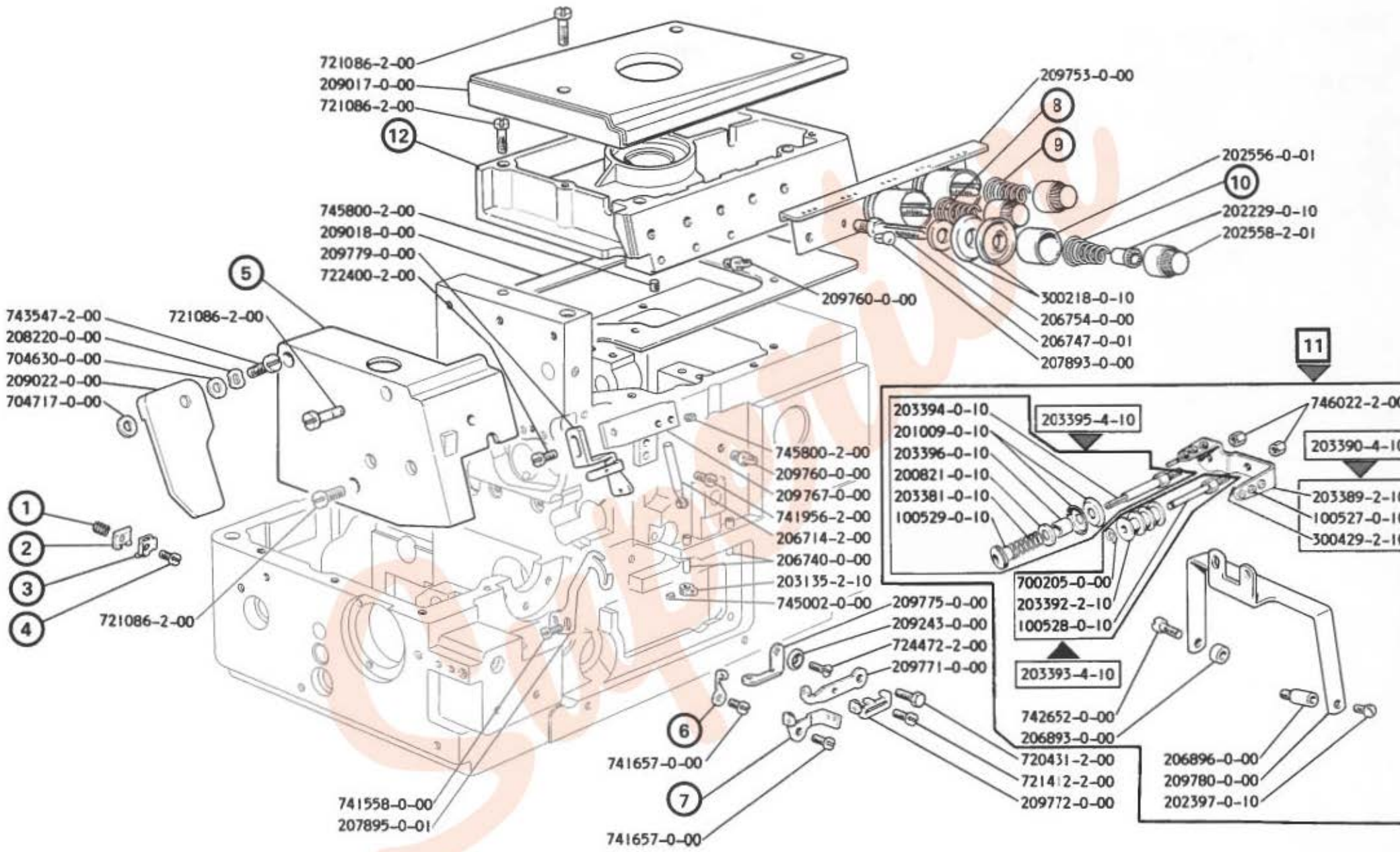

TAV. 2/A

	①	②	③	④	⑤	⑥	⑦	⑧	⑨	⑩	⑪	⑫	⑬
627-00-2CD-13	209173-0-00	209015-0-00	207895-0-01	300827-0-10	---	---	209771-0-00	---	---	---	202681-0-10	---	202681-0-10
627-00-2CD-15	209173-0-00	209015-0-00	207871-0-00	---	---	209775-0-00	209770-0-00	203572-0-10	202278-0-10	720431-2-00	202227-0-10	202681-0-10	202227-0-10
627-00-2CD-16	209173-0-00	209015-0-00	207871-0-00	---	---	209775-0-00	209770-0-00	203572-0-10	202278-0-10	720431-2-00	202227-0-10	202681-0-10	202227-0-10
627-00-2CD-17	209173-0-00	209015-0-00	207871-0-00	---	---	209775-0-00	209770-0-00	203572-0-10	202278-0-10	720431-2-00	202227-0-10	202681-0-10	202227-0-10
627-00-2CD-18	209173-0-00	209015-0-00	207871-0-00	---	---	209775-0-00	209770-0-00	203572-0-10	202278-0-10	720431-2-00	202227-0-10	202681-0-10	202227-0-10
627-00-2CD-31	209159-0-00	209015-0-00	207895-0-01	---	209785-0-00	209775-0-00	209770-0-00	---	---	---	202227-0-10	202227-0-10	202227-0-10
627-00-2CD-32	209173-0-00	209015-0-00	207871-0-00	---	---	209775-0-00	209770-0-00	203572-0-10	202278-0-10	720431-2-00	202227-0-10	202681-0-10	202227-0-10
627-00-2CD-41	209173-0-00	209015-0-00	207895-0-01	---	209785-0-00	209775-0-00	209770-0-00	---	---	---	202227-0-10	202227-0-10	202227-0-10
627-00-2CD-44	209173-0-00	209015-0-00	207895-0-01	300827-0-10	---	---	209771-0-00	---	---	---	202681-0-10	---	202681-0-10
627-00-2CD-45	209173-0-00	209015-0-00	207871-0-00	---	---	209775-0-00	209770-0-00	203572-0-10	202278-0-10	720431-2-00	202227-0-10	202681-0-10	202227-0-10
627-00-2CD-47	209173-0-00	209015-0-00	207895-0-01	300827-0-10	---	---	209771-0-00	---	---	---	202681-0-10	---	202681-0-10
627-00-2MD-02	209173-0-00	209015-0-00	207895-0-01	300827-0-10	---	209775-0-00	209771-0-00	---	---	---	202227-0-10	202681-0-10	202227-0-10
627-00-2MD-20	209173-0-00	209015-0-00	207895-0-01	300827-0-10	---	209775-0-00	209771-0-00	---	---	---	202227-0-10	202681-0-10	202227-0-10
627-00-2MD-21	209173-0-00	209015-0-00	207871-0-00	---	---	209775-0-00	209770-0-00	203572-0-10	202278-0-10	720431-2-00	202227-0-10	202681-0-10	202227-0-10
627-00-2MD-36	209173-0-00	209015-0-00	207895-0-01	300827-0-10	---	209775-0-00	209771-0-00	---	---	---	202227-0-10	202681-0-10	202227-0-10
627-01-2CD-05	209173-0-00	209015-0-00	207871-0-00	---	---	209775-0-00	209770-0-00	203572-0-10	202278-0-10	720431-2-00	202227-0-10	202681-0-10	202227-0-10
627-01-2CD-06	209173-0-00	209015-0-00	207871-0-00	---	---	209775-0-00	209770-0-00	203572-0-10	202278-0-10	720431-2-00	202227-0-10	202681-0-10	202227-0-10
627-01-2CD-20	209173-0-00	209015-0-00	207895-0-01	---	---	209775-0-00	209770-0-00	---	202278-0-10	720431-2-00	202227-0-10	202681-0-10	202227-0-10
627-01-2MD-07	209173-0-00	209015-0-00	207895-0-01	300827-0-10	---	209775-0-00	209771-0-00	---	---	---	202227-0-10	202681-0-10	202227-0-10
627-01-2MD-11	209173-0-00	209015-0-00	207895-0-01	300827-0-10	---	209775-0-00	209771-0-00	---	---	---	202227-0-10	202681-0-10	202227-0-10
627-22-2CD-06	209173-0-00	920499-0-00	207871-0-00	---	---	209775-0-00	209770-0-00	203572-0-10	202278-0-10	720431-2-00	202227-0-10	202681-0-10	202227-0-10
627-22-2CD-31	209159-0-00	920499-0-00	207895-0-01	---	209785-0-00	209775-0-00	209770-0-00	---	---	---	202227-0-10	202681-0-10	202227-0-10



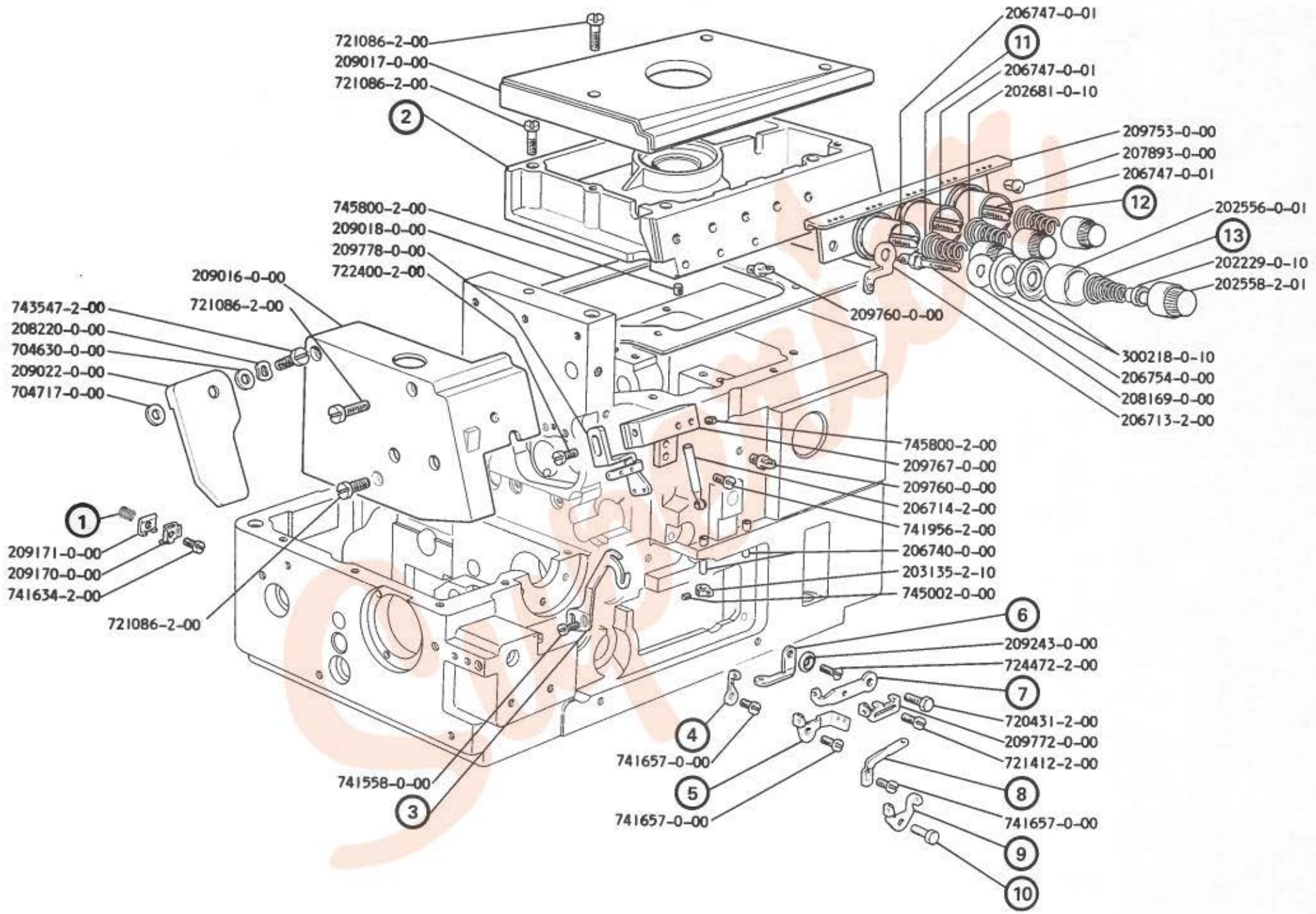

TAV. 3



627-00-1CD-01	209100-2-00	0,9
627-00-1CD-02	209100-2-00	0,9
627-00-1CD-06	209103-2-00	1,1
627-00-1CD-07	209100-2-00	0,9
627-00-1CD-09	209100-2-00	0,9
627-00-1CD-20	209100-2-00	0,9
627-00-1CD-21	209103-2-00	1,1
627-00-1CD-25	209100-2-00	0,9
627-00-1CD-26	209100-2-00	0,9
627-00-1CD-29	209100-2-00	0,9
627-00-1CD-30	209103-2-00	1,1
627-00-1CD-31	209100-2-00	0,9
627-00-1MD-23	209103-2-00	1,1
627-00-1MD-33	209103-2-00	1,1
627-01-1CD-02	209100-2-00	0,9
627-01-1CD-03	209103-2-00	1,1
627-01-1CD-04	209100-2-00	0,9
627-01-1CD-05	209100-2-00	0,9
627-01-1CD-09	209100-2-00	0,9
627-01-1MD-08	209103-2-00	1,1
627-10-1CD-06	209100-2-00	0,9
627-22-1CD-01	209103-2-00	1,1
627-22-1CD-02	209100-2-00	0,9
627-23-1CD-01	209103-2-00	1,1
627-23-1CD-02	209100-2-00	0,9
627-28-1CD-02	209100-2-00	0,9
627-28-1CD-07	209100-2-00	0,9
627-28-1CD-09	209100-2-00	0,9
627-28-1CD-12	209100-2-00	0,9
627-29-1CD-02	209100-2-00	0,9
627-29-1CD-05	209100-2-00	0,9
627-30-1CD-07	209100-2-00	0,9
627-34-1CD-01	209100-2-00	0,9
627-34-1MD-03	209103-2-00	1,1
627-38-1CD-01	209100-2-00	0,9
627-49-1MD-01	209103-2-00	1,1
627-49-1MD-03	209103-2-00	1,1
627-00-2CD-13	209100-2-00	0,9
627-00-2CD-15	209100-2-00	0,9
627-00-2CD-16	209100-2-00	0,9
627-00-2CD-17	209103-2-00	1,1
627-00-2CD-18	209103-2-00	1,1
627-00-2CD-31	209100-2-00	0,9
627-00-2CD-32	209103-2-00	1,1
627-00-2CD-41	209100-2-00	0,9
627-00-2CD-44	209100-2-00	0,9
627-00-2CD-45	209103-2-00	1,1
627-00-2CD-47	209100-2-00	0,9
627-00-2MD-02	209103-2-00	1,1
627-00-2MD-20	209103-2-00	1,1
627-00-2MD-21	209103-2-00	1,1
627-00-2MD-36	209103-2-00	1,1
627-01-2CD-05	209103-2-00	1,1
627-01-2CD-06	209103-2-00	1,1
627-01-2CD-20	209103-2-00	1,1
627-01-2MD-07	209103-2-00	1,1
627-01-2MD-11	209103-2-00	1,1
627-22-2CD-06	209103-2-00	1,1
627-22-2CD-31	209100-2-00	0,9

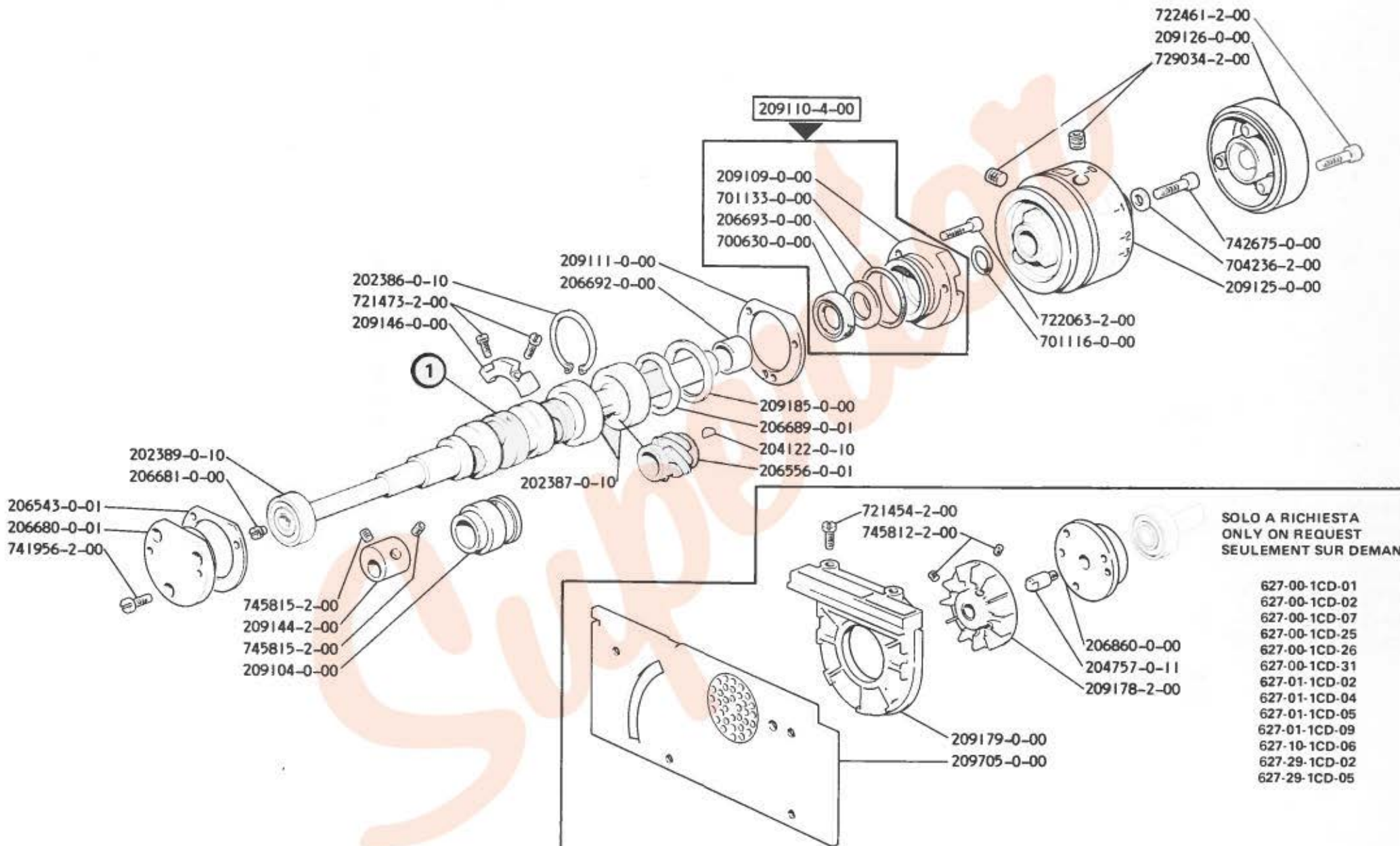

Superior

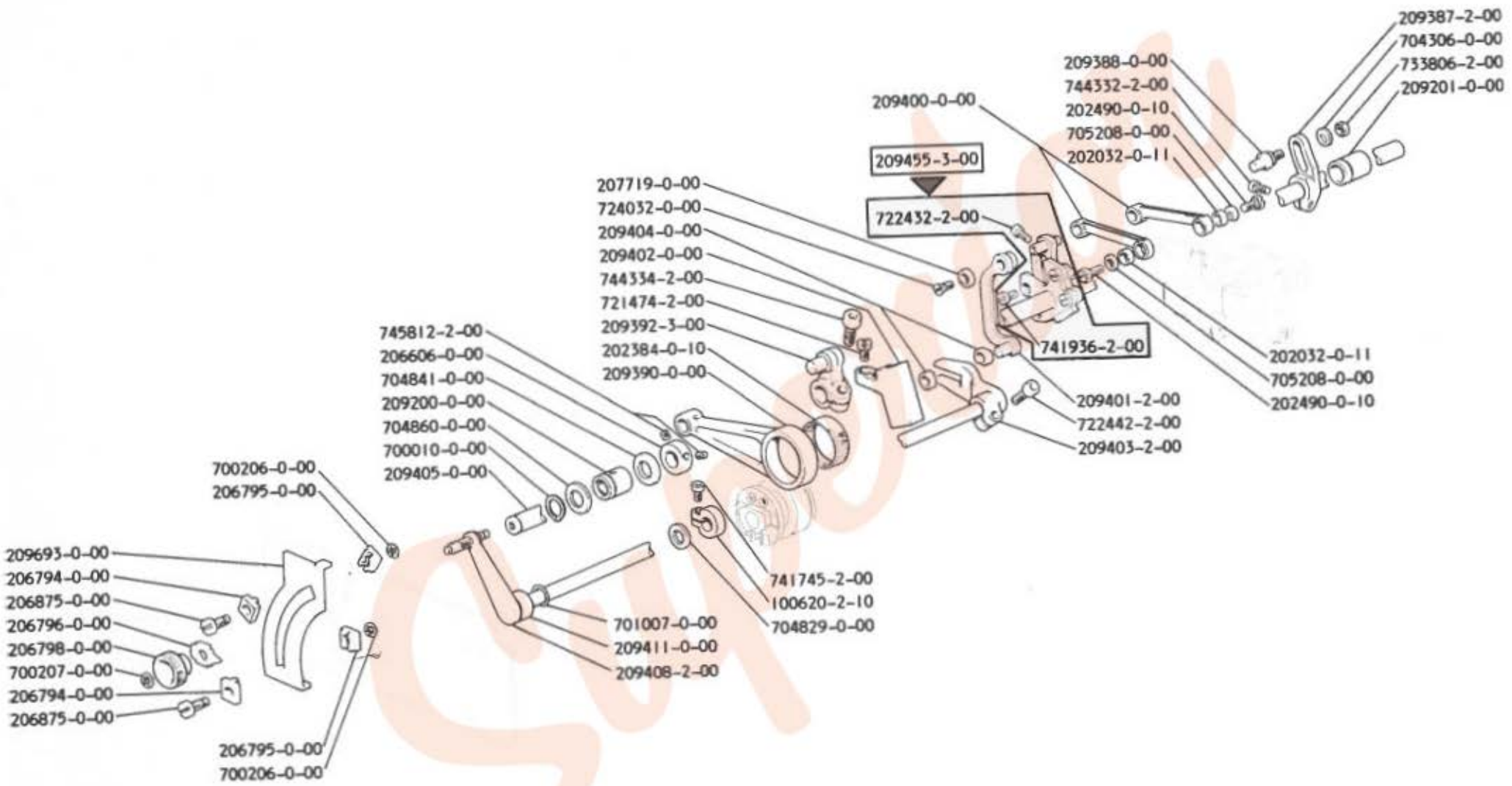

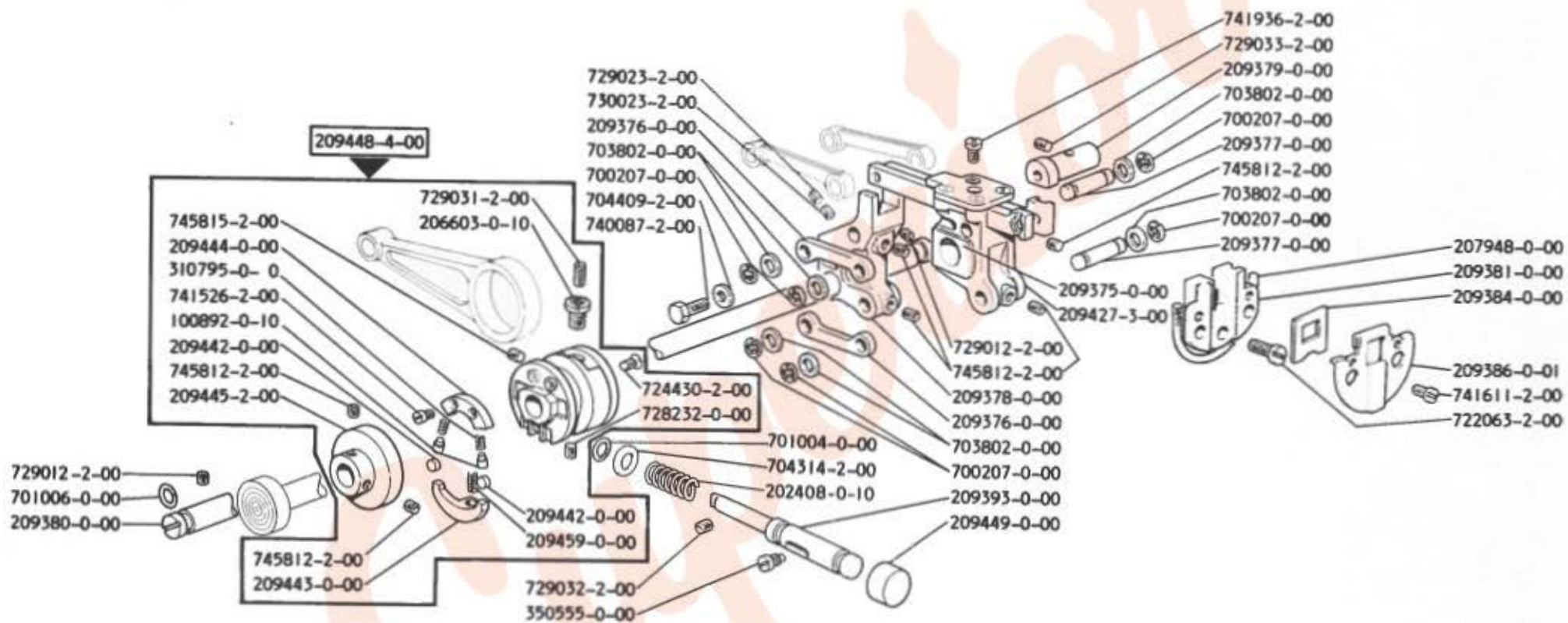



TAV. 5

	①	②		③	
627-00.1CD-01	208015-0-00	206659-2-02	24	704845-0-00	4,5
627-00.1CD-02	208015-0-00	206659-2-02	24	704845-0-00	4,5
627-00.1CD-06	208015-0-00	206659-2-02	24	704845-0-00	4,5
627-00.1CD-07	208015-0-00	206659-2-02	24	704845-0-00	4,5
627-00.1CD-09	208015-0-00	206659-2-02	24	704845-0-00	4,5
627-00.1CD-20	208015-0-00	206659-2-02	24	704845-0-00	4,5
627-00.1CD-21	208015-0-00	206659-2-02	24	704845-0-00	4,5
627-00.1CD-25	208015-0-00	206659-2-02	24	704845-0-00	4,5
627-00.1CD-26	208015-0-00	206659-2-02	24	704845-0-00	4,5
627-00.1CD-29	208015-0-00	206659-2-02	24	704845-0-00	4,5
627-00.1CD-30	208015-0-00	206659-2-02	24	704845-0-00	4,5
627-00.1CD-31	208015-0-00	206659-2-02	24	704845-0-00	4,5
627-00.1MD-23	208015-0-00	206658-2-02	21	704847-0-00	5,9
627-00.1MD-33	208015-0-00	206658-2-02	21	704847-0-00	5,9
627-01.1CD-02	208015-0-00	206659-2-02	24	704845-0-00	4,5
627-01.1CD-03	208015-0-00	206659-2-02	24	704845-0-00	4,5
627-01.1CD-04	208015-0-00	206659-2-02	24	704845-0-00	4,5
627-01.1CD-05	208015-0-00	206659-2-02	24	704845-0-00	4,5
627-01.1CD-09	208015-0-00	206659-2-02	24	704845-0-00	4,5
627-01.1MD-08	208015-0-00	206658-2-02	21	704847-0-00	5,9
627-10.1CD-06	208015-0-00	206659-2-02	24	704845-0-00	4,5
627-22.1CD-01	208015-0-00	206659-2-02	24	704845-0-00	4,5
627-22.1CD-02	208015-0-00	206659-2-02	24	704845-0-00	4,5
627-23.1CD-01	208015-0-00	206659-2-02	24	704845-0-00	4,5
627-23.1CD-02	208015-0-00	206659-2-02	24	704845-0-00	4,5
627-28.1CD-02	208015-0-00	206659-2-02	24	704845-0-00	4,5
627-28.1CD-07	208015-0-00	206659-2-02	24	704845-0-00	4,5
627-28.1CD-09	208015-0-00	206659-2-02	24	704845-0-00	4,5
627-28.1CD-12	208015-0-00	206659-2-02	24	704845-0-00	4,5
627-29.1CD-02	208015-0-00	206659-2-02	24	704845-0-00	4,5
627-29.1CD-05	208015-0-00	206659-2-02	24	704845-0-00	4,5
627-30.1CD-07	208015-0-00	206659-2-02	24	704845-0-00	4,5
627-34.1CD-01	208015-0-00	206659-2-02	24	704845-0-00	4,5
627-34.1MD-03	208015-0-00	206658-2-02	21	704847-0-00	5,9
627-38.1CD-01	208015-0-00	206659-2-02	24	704845-0-00	4,5
627-49.1MD-01	208015-0-00	206658-2-02	21	704847-0-00	5,9
627-49.1MD-03	208015-0-00	206658-2-02	21	704847-0-00	5,9
627-00.2CD-13	209774-0-00	206659-2-02	24	704848-0-00	2
627-00.2CD-15	209774-0-00	206658-2-02	21	704848-0-00	2
627-00.2CD-16	209774-0-00	206658-2-02	21	704848-0-00	2
627-00.2CD-17	209774-0-00	206658-2-02	21	704848-0-00	2
627-00.2CD-18	209774-0-00	206658-2-02	21	704848-0-00	2
627-00.2CD-31	209774-0-00	206659-2-02	24	704845-0-00	4,5
627-00.2CD-32	209774-0-00	206658-2-02	21	704848-0-00	2
627-00.2CD-41	209774-0-00	206658-2-02	21	704848-0-00	2
627-00.2CD-44	209774-0-00	206659-2-02	24	704848-0-00	2
627-00.2CD-45	209774-0-00	206658-2-02	21	704848-0-00	2
627-00.2CD-47	209774-0-00	206659-2-02	24	704848-0-00	2
627-00.2MD-02	209774-0-00	206658-2-02	21	704848-0-00	2
627-00.2MD-20	209774-0-00	206658-2-02	21	704848-0-00	2
627-00.2MD-21	209774-0-00	206658-2-02	21	704848-0-00	2
627-00.2MD-36	209774-0-00	206658-2-02	21	704848-0-00	2
627-01.2CD-05	209774-0-00	206658-2-02	21	704848-0-00	2
627-01.2CD-06	209774-0-00	206658-2-02	21	704848-0-00	2
627-01.2CD-20	209774-0-00	206658-2-02	21	704848-0-00	2
627-01.2MD-07	209774-0-00	206658-2-02	21	704848-0-00	2
627-01.2MD-11	209774-0-00	206658-2-02	21	704848-0-00	2
627-22.2CD-06	209774-0-00	206658-2-02	21	704848-0-00	2
627-22.2CD-31	209774-0-00	206659-2-02	24	704845-0-00	4,5

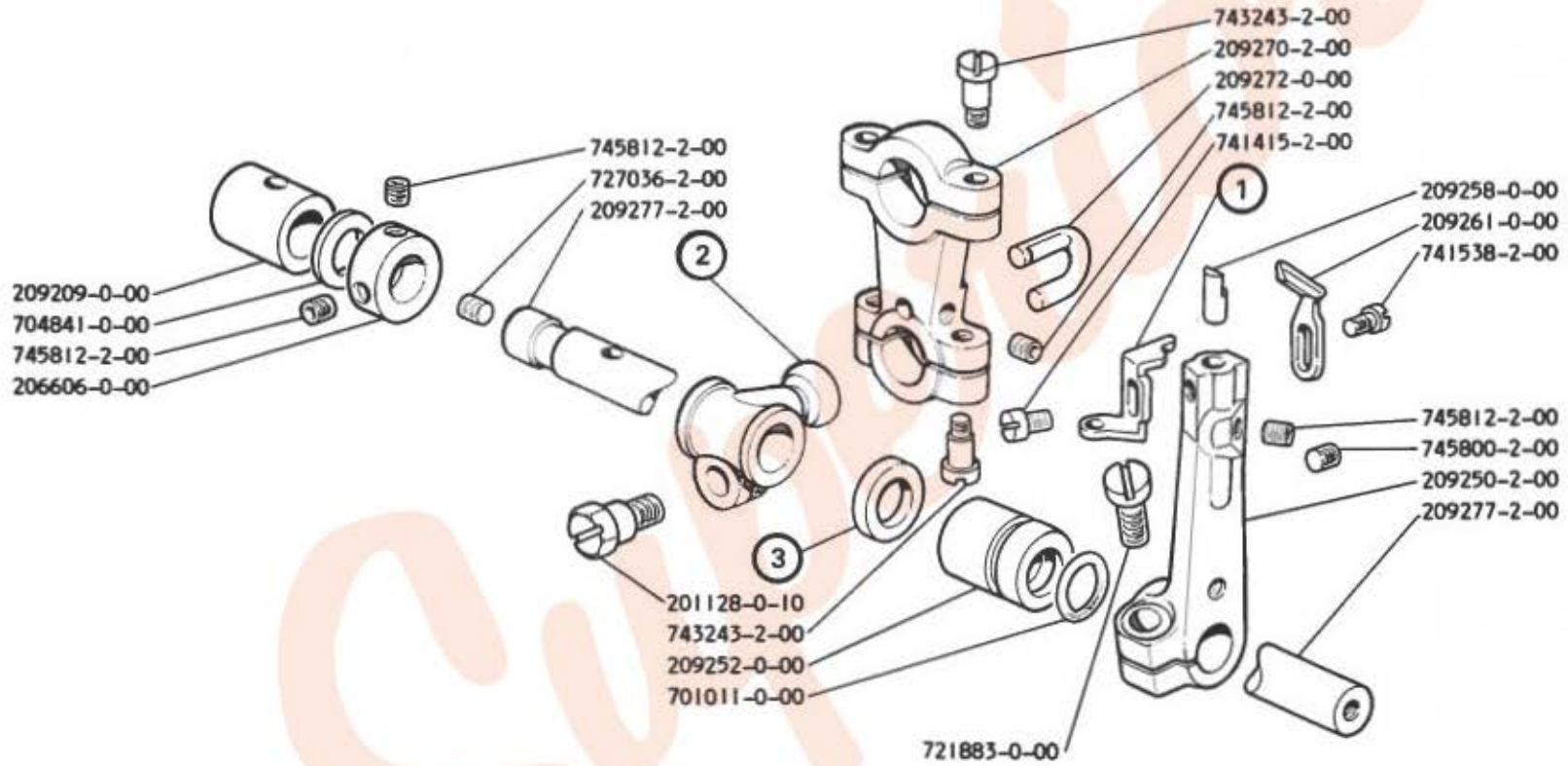

TAV. 6

	①	②	③	④	⑤	
627-00-1CD-01	209241-3-00	209205-2-00	209270-2-00	206658-2-02	21	704848-0-00 2
627-00-1CD-02	209241-3-00	209205-2-00	209270-2-00	206658-2-02	21	704848-0-00 2
627-00-1CD-06	209241-3-00	209205-2-00	209270-2-00	206649-2-02	20	704845-0-00 4,5
627-00-1CD-07	209241-3-00	209205-2-00	209270-2-00	206658-2-02	21	704848-0-00 2
627-00-1CD-09	209241-3-00	209205-2-00	209270-2-00	206658-2-02	21	704848-0-00 2
627-00-1CD-20	209241-3-00	209205-2-00	209270-2-00	206658-2-02	21	704848-0-00 2
627-00-1CD-21	209241-3-00	209205-2-00	209270-2-00	206649-2-02	20	704845-0-00 4,5
627-00-1CD-25	209241-3-00	209205-2-00	209270-2-00	206658-2-02	21	704848-0-00 2
627-00-1CD-26	209241-3-00	209205-2-00	209270-2-00	206658-2-02	21	704848-0-00 2
627-00-1CD-29	209241-3-00	209205-2-00	209270-2-00	206658-2-02	21	704848-0-00 2
627-00-1CD-30	209241-3-00	209205-2-00	209270-2-00	206649-2-02	20	704845-0-00 4,5
627-00-1CD-31	209241-3-00	209205-2-00	209270-2-00	206658-2-02	21	704848-0-00 2
627-00-1MD-23	209234-3-00	209204-2-00	209270-2-00	206648-2-02	18	704847-0-00 5,9
627-00-1MD-33	209234-3-00	209204-2-00	209270-2-00	206648-2-02	18	704847-0-00 5,9
627-01-1CD-02	209241-3-00	209205-2-00	209270-2-00	206658-2-02	21	704848-0-00 2
627-01-1CD-03	209241-3-00	209205-2-00	209270-2-00	206649-2-02	20	704845-0-00 4,5
627-01-1CD-04	209241-3-00	209205-2-00	209270-2-00	206658-2-02	21	704848-0-00 2
627-01-1CD-05	209241-3-00	209205-2-00	209270-2-00	206658-2-02	21	704848-0-00 2
627-01-1CD-09	209241-3-00	209205-2-00	209270-2-00	206658-2-02	21	704848-0-00 2
627-01-1MD-08	209234-3-00	209204-2-00	209270-2-00	206648-2-02	18	704847-0-00 5,9
627-10-1CD-06	209241-3-00	209205-2-00	209270-2-00	206658-2-02	21	704848-0-00 2
627-22-1CD-01	209241-3-00	209205-2-00	209270-2-00	206649-2-02	20	704845-0-00 4,5
627-22-1CD-02	209241-3-00	209205-2-00	209270-2-00	206658-2-02	21	704848-0-00 2
627-23-1CD-01	209241-3-00	209205-2-00	209270-2-00	206649-2-02	20	704845-0-00 4,5
627-23-1CD-02	209241-3-00	209205-2-00	209270-2-00	206658-2-02	21	704848-0-00 2
627-28-1CD-02	209241-3-00	209205-2-00	209270-2-00	206658-2-02	21	704848-0-00 2
627-28-1CD-07	209241-3-00	209205-2-00	209270-2-00	206658-2-02	21	704848-0-00 2
627-28-1CD-09	209241-3-00	209205-2-00	209270-2-00	206658-2-02	21	704848-0-00 2
627-28-1CD-12	209241-3-00	209205-2-00	209270-2-00	206658-2-02	21	704848-0-00 2
627-29-1CD-02	209241-3-00	209205-2-00	209270-2-00	206658-2-02	21	704848-0-00 2
627-29-1CD-05	209241-3-00	209205-2-00	209270-2-00	206658-2-02	21	704848-0-00 2
627-30-1CD-07	209241-3-00	209205-2-00	209270-2-00	206649-2-02	20	704848-0-00 2
627-34-1CD-01	209241-3-00	209205-2-00	209270-2-00	206658-2-02	21	704848-0-00 2
627-34-1MD-03	209234-3-00	209204-2-00	209270-2-00	206648-2-02	18	704847-0-00 5,9
627-38-1CD-01	209241-3-00	209205-2-00	209270-2-00	206658-2-02	21	704848-0-00 2
627-49-1MD-01	209234-3-00	209204-2-00	209270-2-00	206648-2-02	18	704847-0-00 5,9
627-49-1MD-03	209234-3-00	209204-2-00	209270-2-00	206648-2-02	18	704847-0-00 5,9
627-00-2CD-13	209241-3-00	209205-2-00	209270-2-00	206658-2-02	21	704840-0-00 3,9
627-00-2CD-15	209241-3-00	209205-2-00	209270-2-00	206658-2-02	21	704845-0-00 4,5
627-00-2CD-16	209241-3-00	209205-2-00	209270-2-00	206658-2-02	21	704845-0-00 4,5
627-00-2CD-17	209241-3-00	209205-2-00	209270-2-00	206658-2-02	21	704845-0-00 4,5
627-00-2CD-18	209241-3-00	209205-2-00	209270-2-00	206658-2-02	21	704840-0-00 3,9
627-00-2CD-31	209241-3-00	209204-2-00	209270-2-00	209218-2-00	19	704848-0-00 2
627-00-2CD-32	209241-3-00	209205-2-00	209270-2-00	206658-2-02	21	704845-0-00 4,5
627-00-2CD-41	209241-3-00	209205-2-00	209270-2-00	209218-2-00	19	704848-0-00 2
627-00-2CD-44	209241-3-00	209205-2-00	209270-2-00	206658-2-02	21	704840-0-00 3,9
627-00-2CD-45	209241-3-00	209205-2-00	209270-2-00	206658-2-02	21	704845-0-00 4,5
627-00-2CD-47	209241-3-00	209205-2-00	209270-2-00	206658-2-02	21	704840-0-00 3,9
627-00-2MD-02	209234-3-00	209204-2-00	209239-2-00	207730-2-02	16,9	704840-0-00 3,9
627-00-2MD-20	209234-3-00	209204-2-00	209239-2-00	207730-2-02	16,9	704840-0-00 3,9
627-00-2MD-21	209241-3-00	209204-2-00	209270-2-00	206649-2-02	20	704847-0-00 5,9
627-00-2MD-36	209234-3-00	209204-2-00	209270-2-00	206648-2-02	18	704840-0-00 3,9
627-01-2CD-05	209241-3-00	209205-2-00	209270-2-00	206658-2-02	21	704845-0-00 4,5
627-01-2CD-06	209241-3-00	209205-2-00	209270-2-00	206658-2-02	21	704840-0-00 3,9
627-01-2CD-20	209241-3-00	209205-2-00	209270-2-00	209218-2-00	19	704840-0-00 3,9
627-01-2MD-07	209234-3-00	209204-2-00	209239-2-00	207730-2-02	16,9	704840-0-00 3,9
627-01-2MD-11	209234-3-00	209204-2-00	209270-2-00	206648-2-02	18	704840-0-00 3,9
627-22-2CD-06	209241-3-00	209205-2-00	209270-2-00	206658-2-02	21	704848-0-00 2
627-22-2CD-31	209241-3-00	209204-2-00	209270-2-00	209218-2-00	19	704848-0-00 2

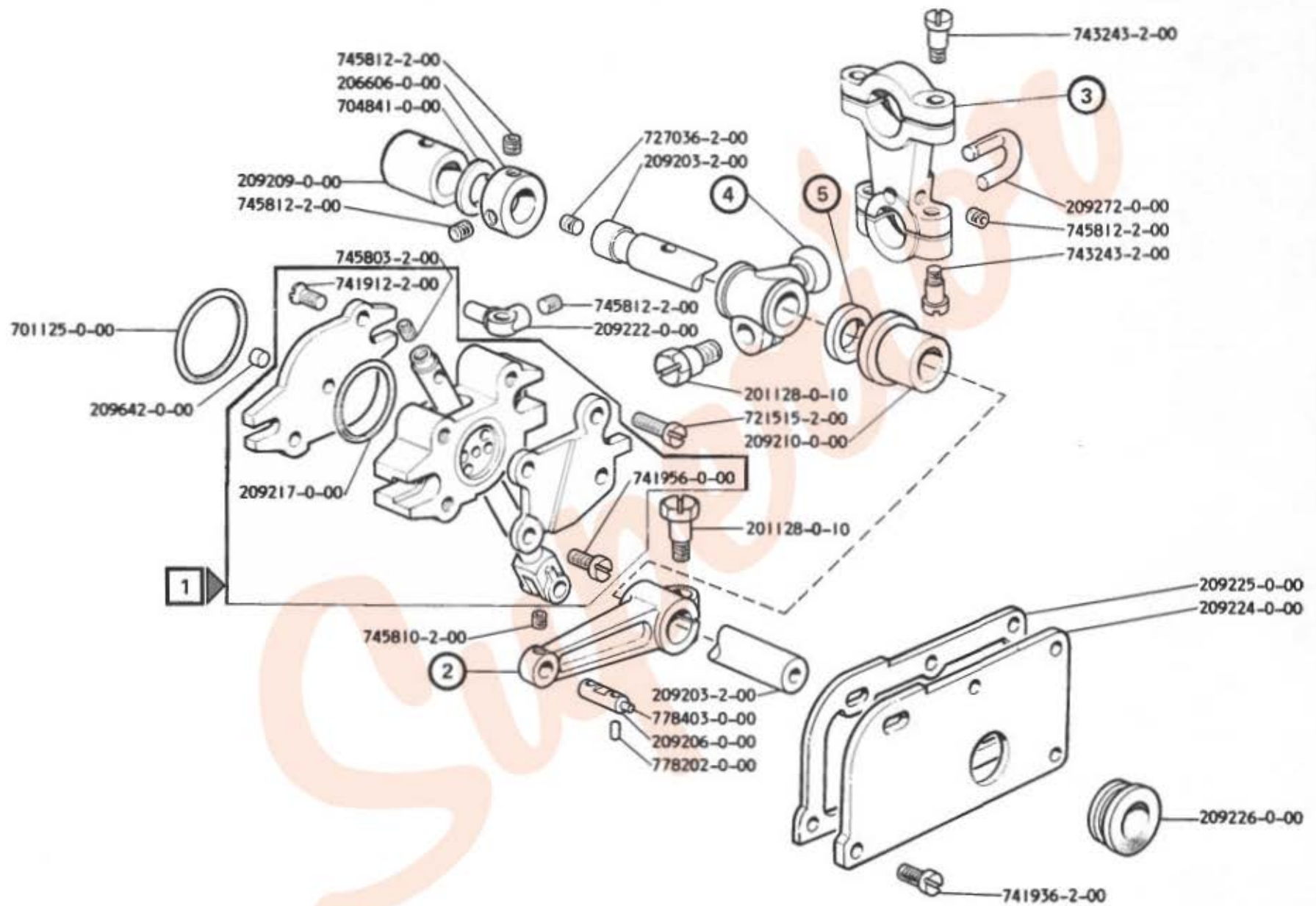

TAV. 7

		①	$\frac{1}{1}$
627-00-1CD-01	209140-2-00		24
627-00-1CD-02	209140-2-00		24
627-00-1CD-06	209140-2-00		24
627-00-1CD-07	209140-2-00		24
627-00-1CD-09	209140-2-00		24
627-00-1CD-20	209140-2-00		24
627-00-1CD-21	209140-2-00		24
627-00-1CD-25	209140-2-00		24
627-00-1CD-26	209140-2-00		24
627-00-1CD-29	209140-2-00		24
627-00-1CD-30	209140-2-00		24
627-00-1CD-31	209140-2-00		24
627-00-1MD-23	209142-2-00		26
627-00-1MD-33	209142-2-00		26
627-01-1CD-02	209140-2-00		24
627-01-1CD-03	209140-2-00		24
627-01-1CD-04	209140-2-00		24
627-01-1CD-05	209140-2-00		24
627-01-1CD-09	209140-2-00		24
627-01-1MD-08	209142-2-00		26
627-10-1CD-06	209140-2-00		24
627-22-1CD-01	209140-2-00		24
627-22-1CD-02	209140-2-00		24
627-23-1CD-01	209140-2-00		24
627-23-1CD-02	209140-2-00		24
627-28-1CD-02	209140-2-00		24
627-28-1CD-07	209140-2-00		24
627-28-1CD-09	209140-2-00		24
627-28-1CD-12	209140-2-00		24
627-29-1CD-02	209140-2-00		24
627-29-1CD-05	209140-2-00		24
627-30-1CD-07	209140-2-00		24
627-34-1CD-01	209140-2-00		24
627-34-1MD-03	209142-2-00		26
627-38-1CD-01	209140-2-00		24
627-49-1MD-01	209142-2-00		26
627-49-1MD-03	209142-2-00		26
627-00-2CD-13	209140-2-00		24
627-00-2CD-15	209141-2-00		25
627-00-2CD-16	209141-2-00		25
627-00-2CD-17	209141-2-00		25
627-00-2CD-18	209141-2-00		25
627-00-2CD-31	209141-2-00		25
627-00-2CD-32	209141-2-00		25
627-00-2CD-41	209141-2-00		25
627-00-2CD-44	209140-2-00		24
627-00-2CD-45	209141-2-00		25
627-00-2CD-47	209140-2-00		24
627-00-2MD-02	209142-2-00		26
627-00-2MD-20	209142-2-00		26
627-00-2MD-21	209142-2-00		26
627-00-2MD-36	209142-2-00		26
627-01-2CD-05	209141-2-00		25
627-01-2CD-06	209141-2-00		25
627-01-2CD-20	209140-2-00		24
627-01-2MD-07	209142-2-00		26
627-01-2MD-11	209142-2-00		26
627-22-2CD-06	209141-2-00		25
627-22-2CD-31	209141-2-00		25

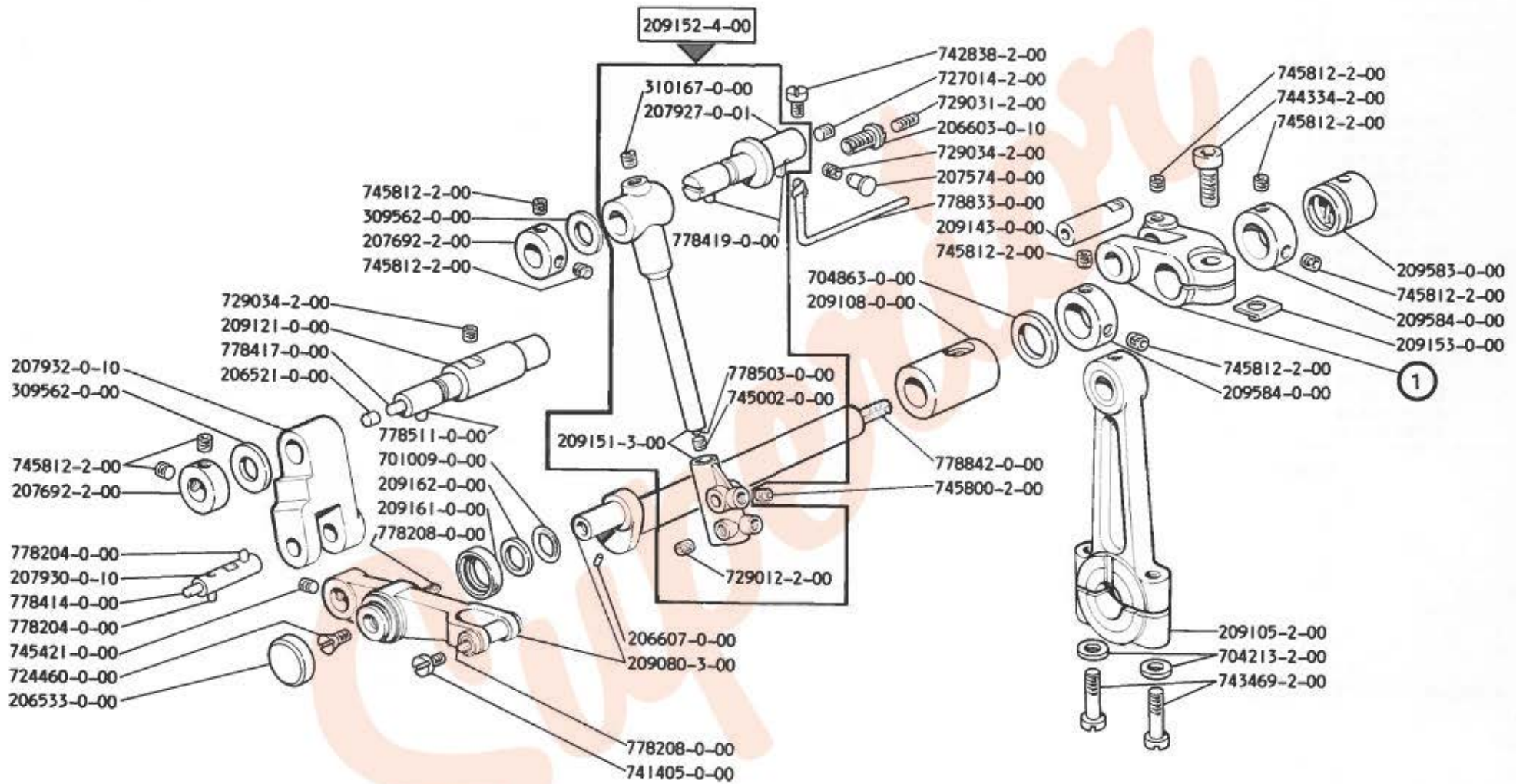

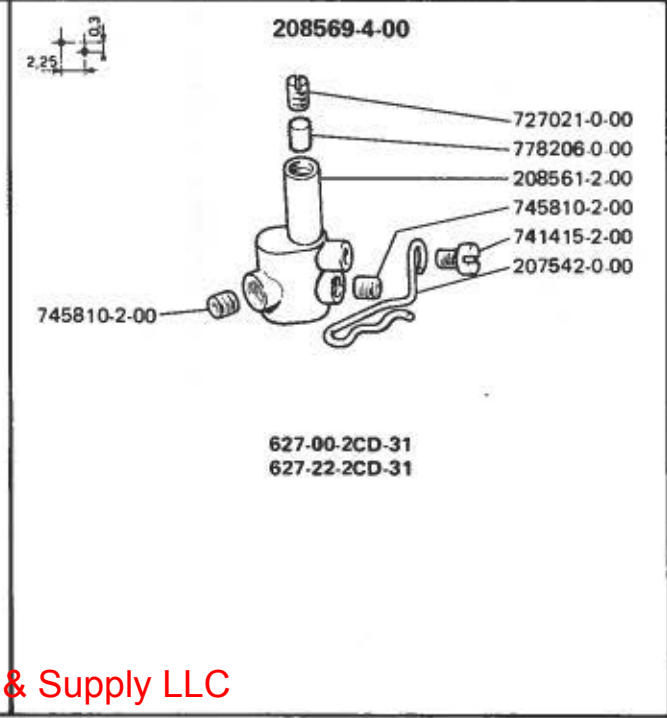
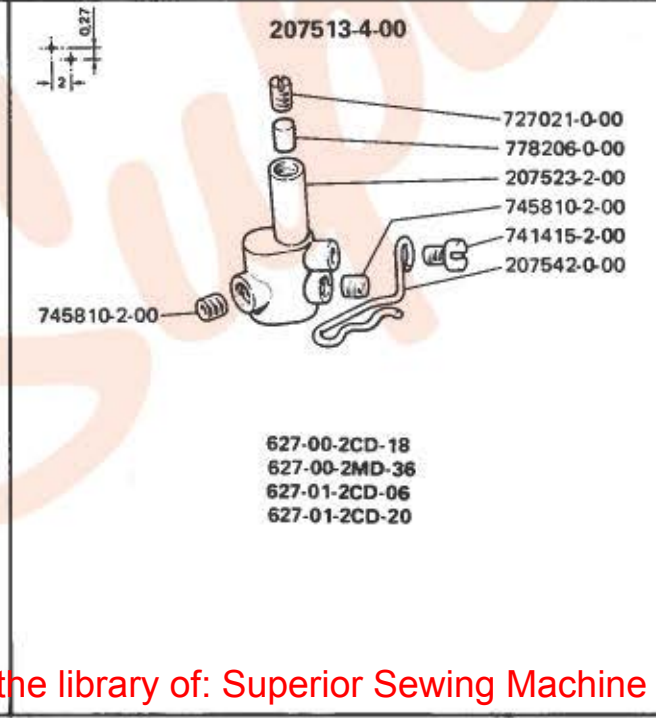
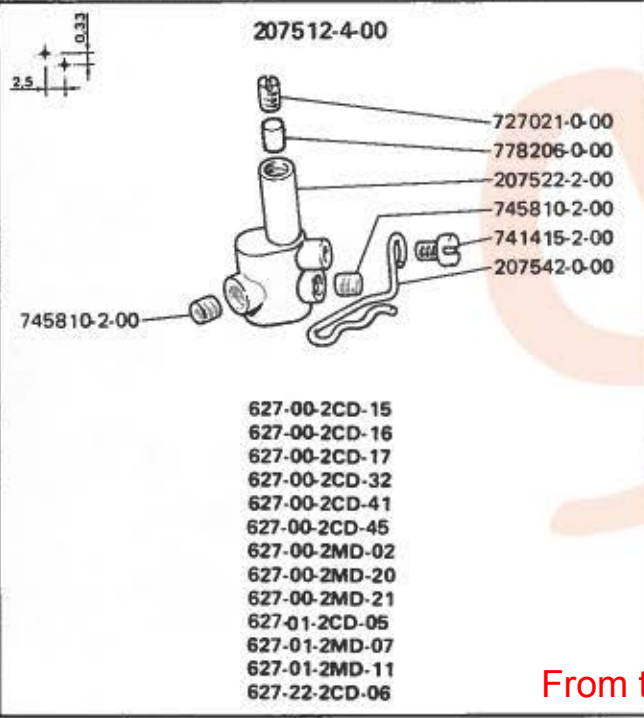
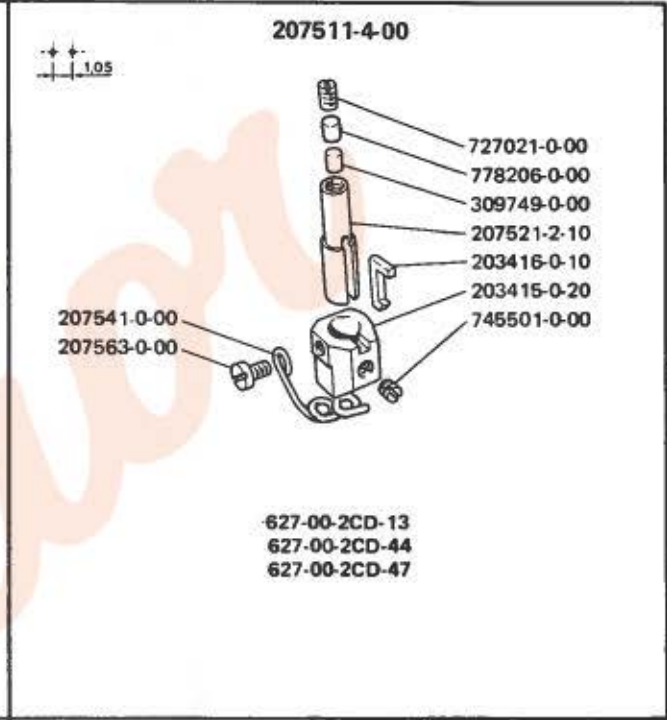
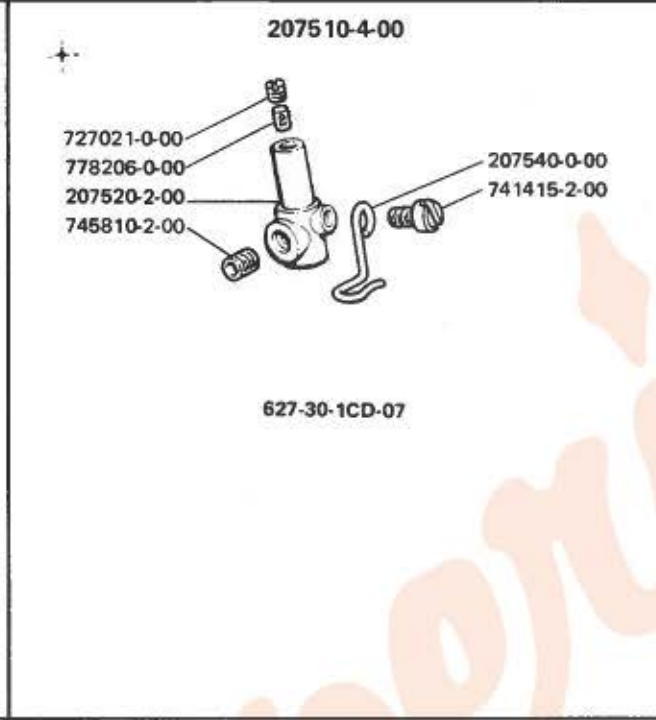
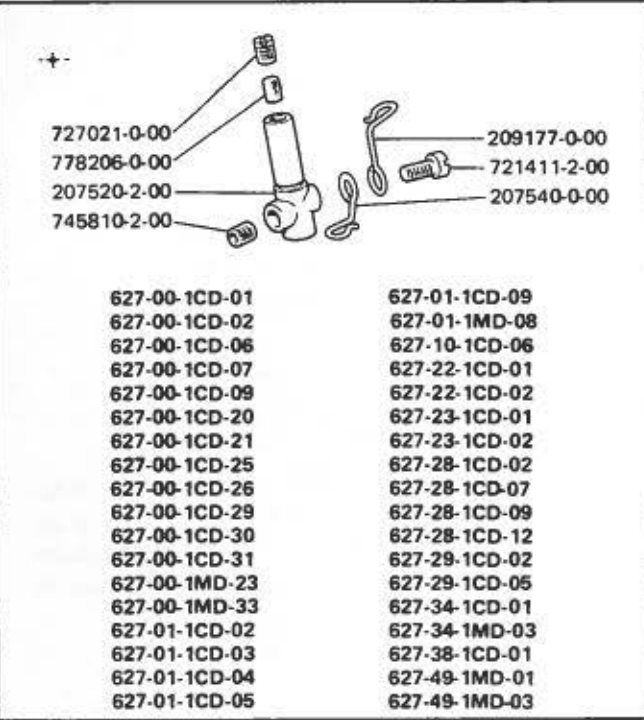

765200-1-60	765200-1-70	765200-1-80	765200-1-90	765200-1-10	765400-1-60	765400-1-80	765400-1-90
627-00-1CD-09 627-28-1CD-07 627-28-1CD-12	627-00-1CD-02 627-00-1CD-31 627-28-1CD-09 627-00-2CD-31	627-00-1CD-01 627-00-1CD-07 627-00-1CD-25 627-00-1CD-26 627-01-1CD-02 627-01-1CD-04 627-01-1CD-05 627-01-1CD-09 627-10-1CD-06 627-29-1CD-02 627-29-1CD-05 627-00-2CD-15 627-00-2CD-16 627-00-2CD-32 627-00-2CD-41 627-22-2CD-31	627-00-1CD-06 627-00-1CD-20 627-00-1CD-21 627-00-1CD-29 627-00-1CD-30 627-01-1CD-03 627-22-1CD-02 627-23-1CD-02 627-28-1CD-02 627-30-1CD-07 627-34-1CD-01 627-34-1MD-03 627-38-1CD-01 627-00-2CD-18 627-00-2MD-36	627-00-1MD-22 627-00-1MD-23 627-01-1MD-08 627-22-1CD-01 627-23-1CD-01 627-49-1MD-01 627-49-1MD-03 627-00-2CD-17 627-00-2CD-45 627-00-2MD-02 627-00-2MD-20 627-00-2MD-21 627-01-2CD-05 627-01-2MD-07 627-22-2CD-06	627-00-2CD-44	627-00-2CD-13 627-00-2CD-47	627-01-2CD-06 627-01-2CD-20 627-01-2MD-11

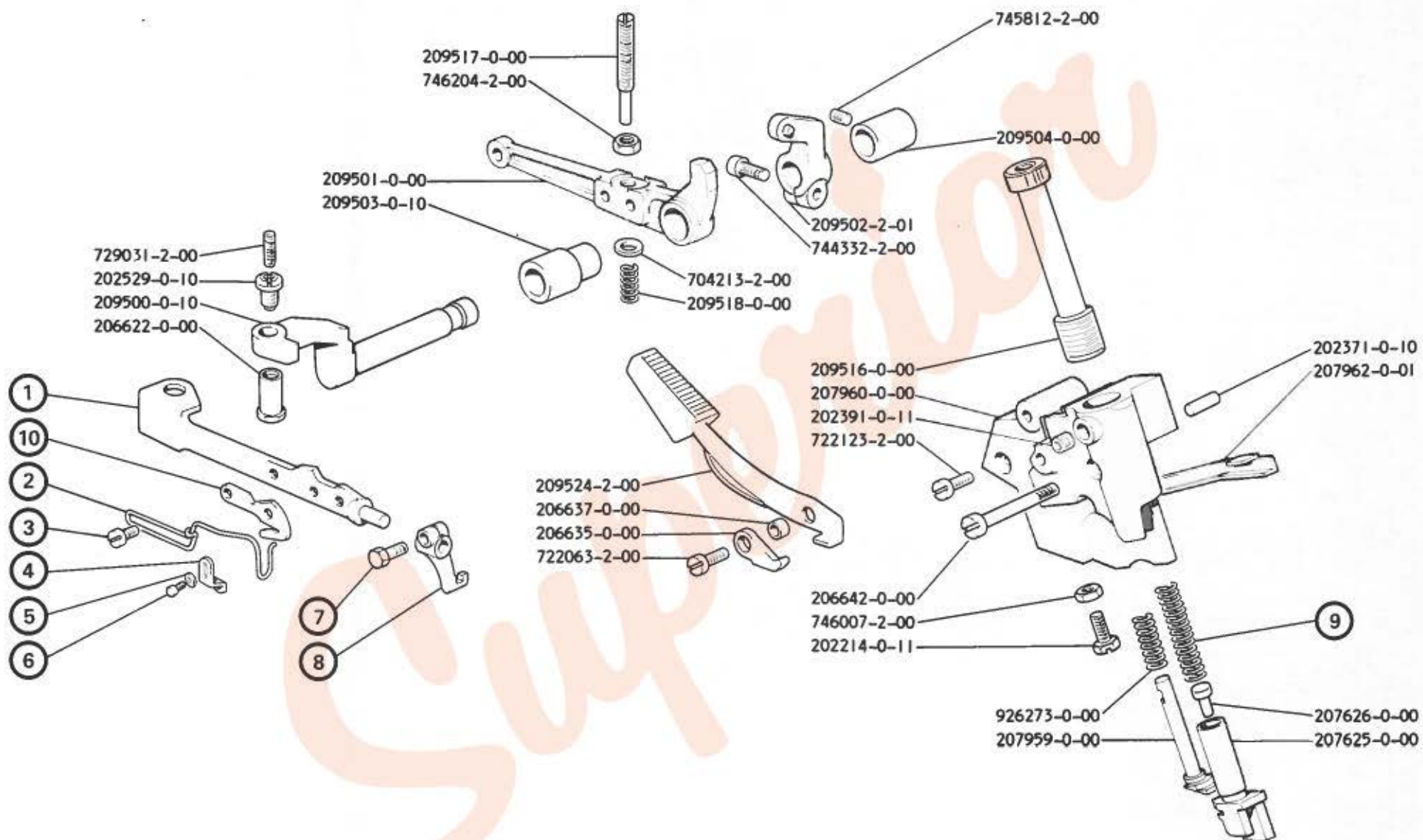

SOLO A RICHIESTA
ONLY ON REQUEST
SEULEMENT SUR DEMANDE

203525-0-11
209590-0-00
202629-0-10
202620-0-10
205191-0-10

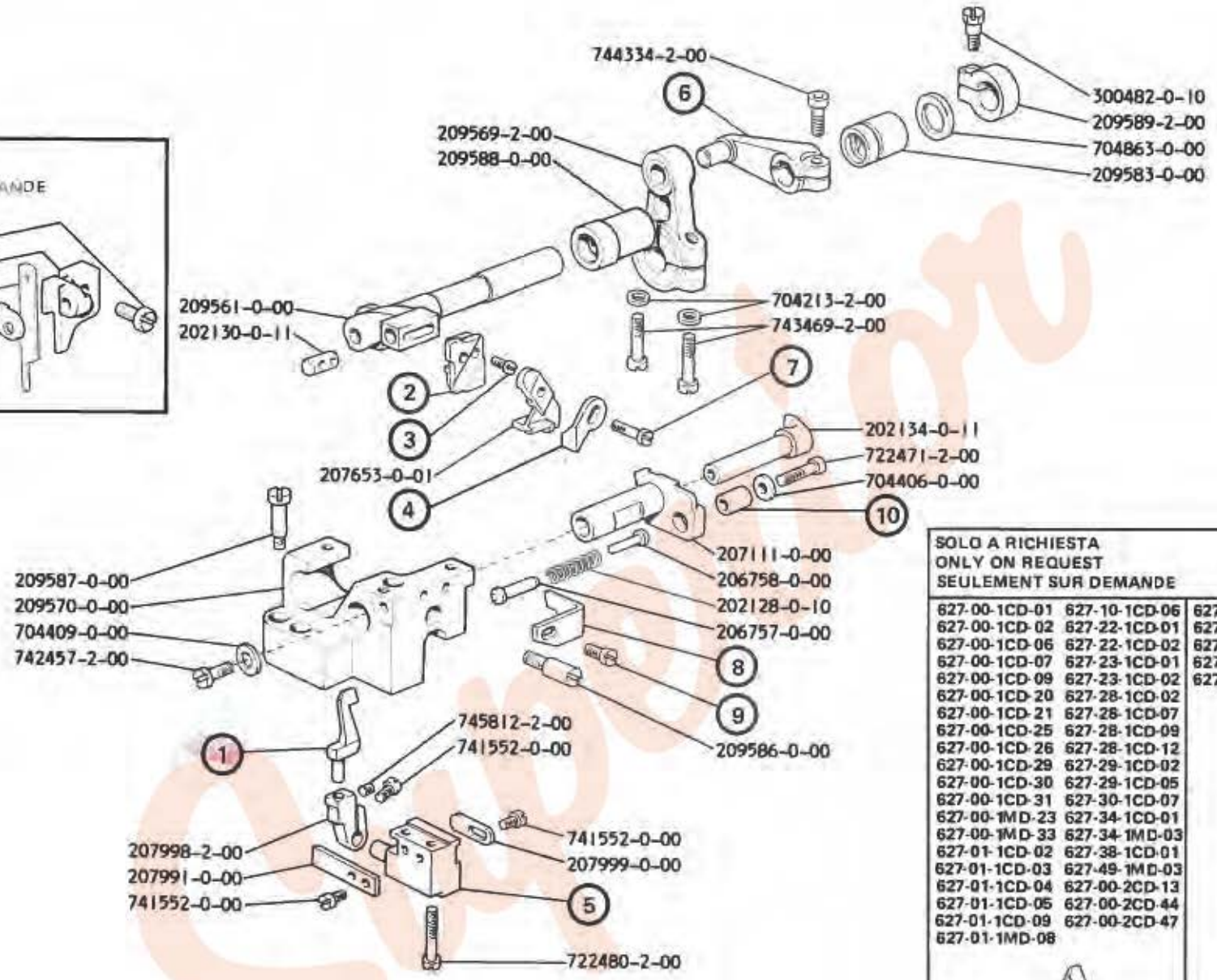

SOLO A RICHIESTA
ONLY ON REQUEST
SEULEMENT SUR DEMANDE

627-00-1CD-01	627-10-1CD-06	627-00-2CD-18	627-00-2CD-15
627-00-1CD-02	627-22-1CD-01	627-00-2MD-36	627-00-2CD-18
627-00-1CD-06	627-22-1CD-02	627-01-2CD-06	627-00-2CD-17
627-00-1CD-07	627-23-1CD-01	627-01-2CD-20	627-00-2CD-31
627-00-1CD-09	627-23-1CD-02	627-01-2MD-11	627-00-2CD-32
627-00-1CD-20	627-28-1CD-02		627-00-2CD-41
627-00-1CD-21	627-28-1CD-07		627-00-2CD-45
627-00-1CD-25	627-28-1CD-09		627-00-2MD-04
627-00-1CD-26	627-28-1CD-12		627-00-2MD-20
627-00-1CD-29	627-29-1CD-02		627-00-2MD-21
627-00-1CD-30	627-29-1CD-05		627-01-2CD-05
627-00-1CD-31	627-30-1CD-07		627-01-2MD-07
627-00-1MD-23	627-34-1CD-01		627-22-2CD-06
627-00-1MD-33	627-34-1MD-03		627-22-2CD-31
627-01-1CD-02	627-38-1CD-01		
627-01-1CD-03	627-49-1MD-03		
627-01-1CD-04	627-00-2CD-13		
627-01-1CD-05	627-00-2CD-44		
627-01-1CD-09	627-00-2CD-47		
627-01-1MD-08			

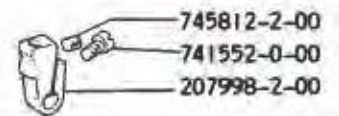

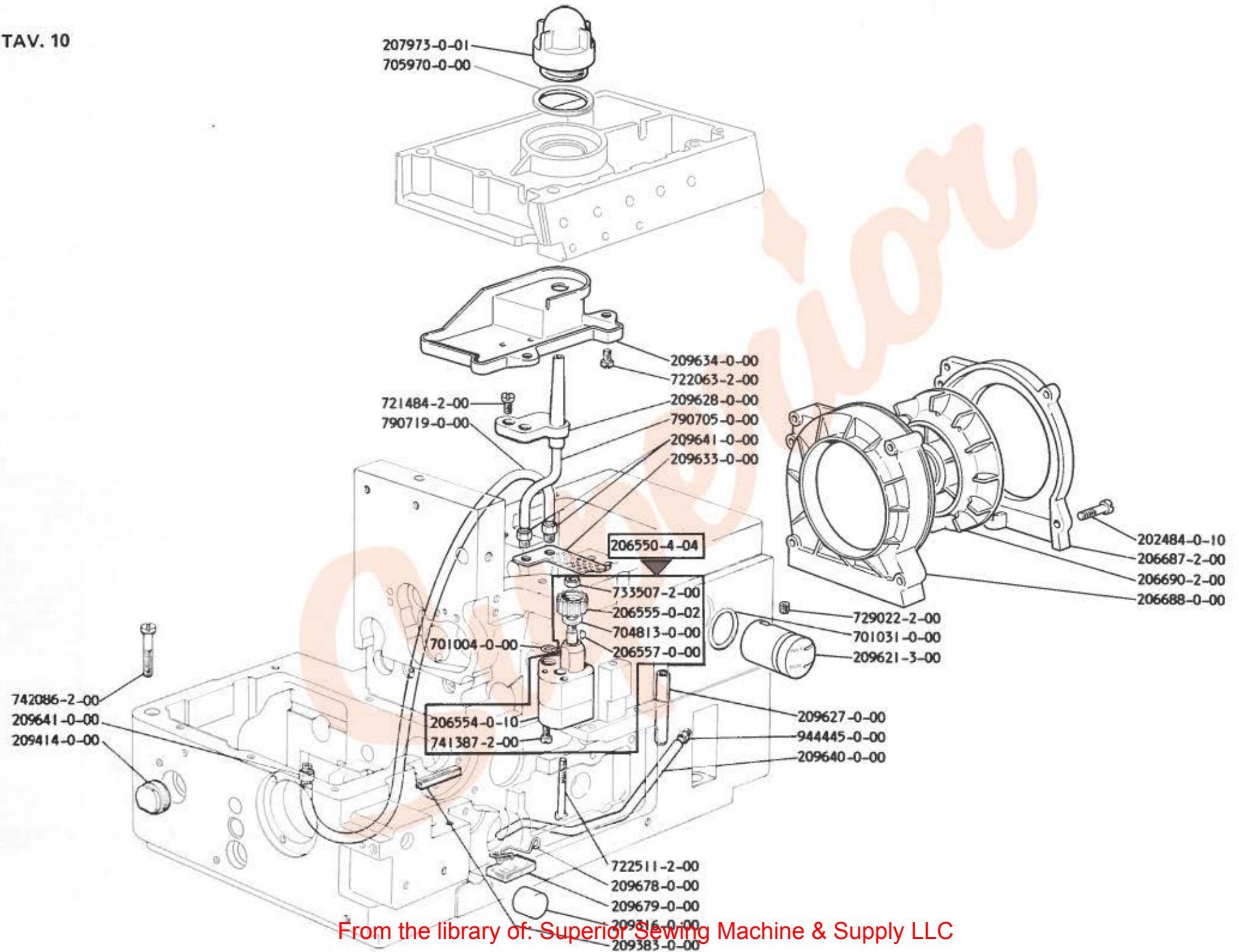

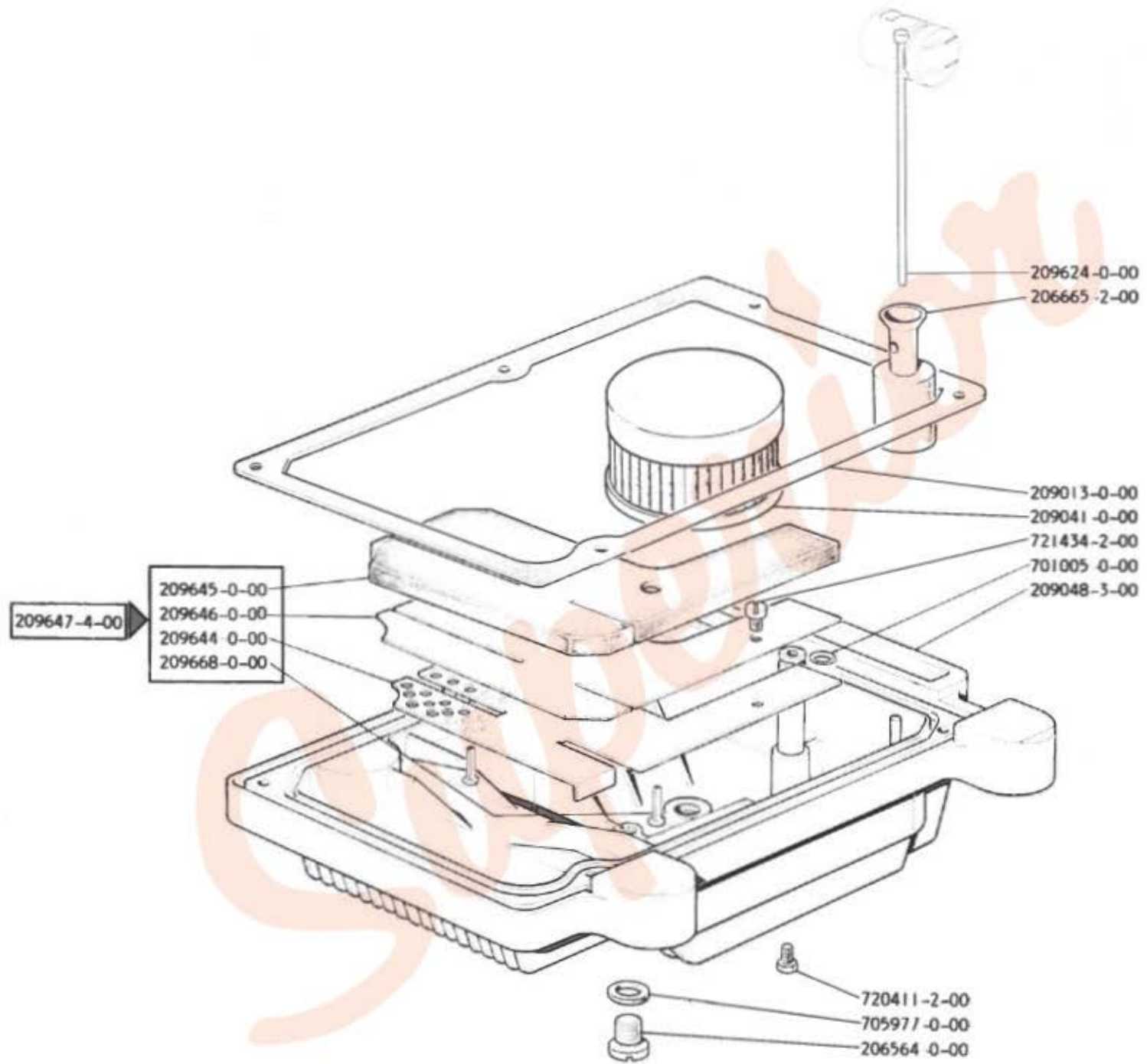

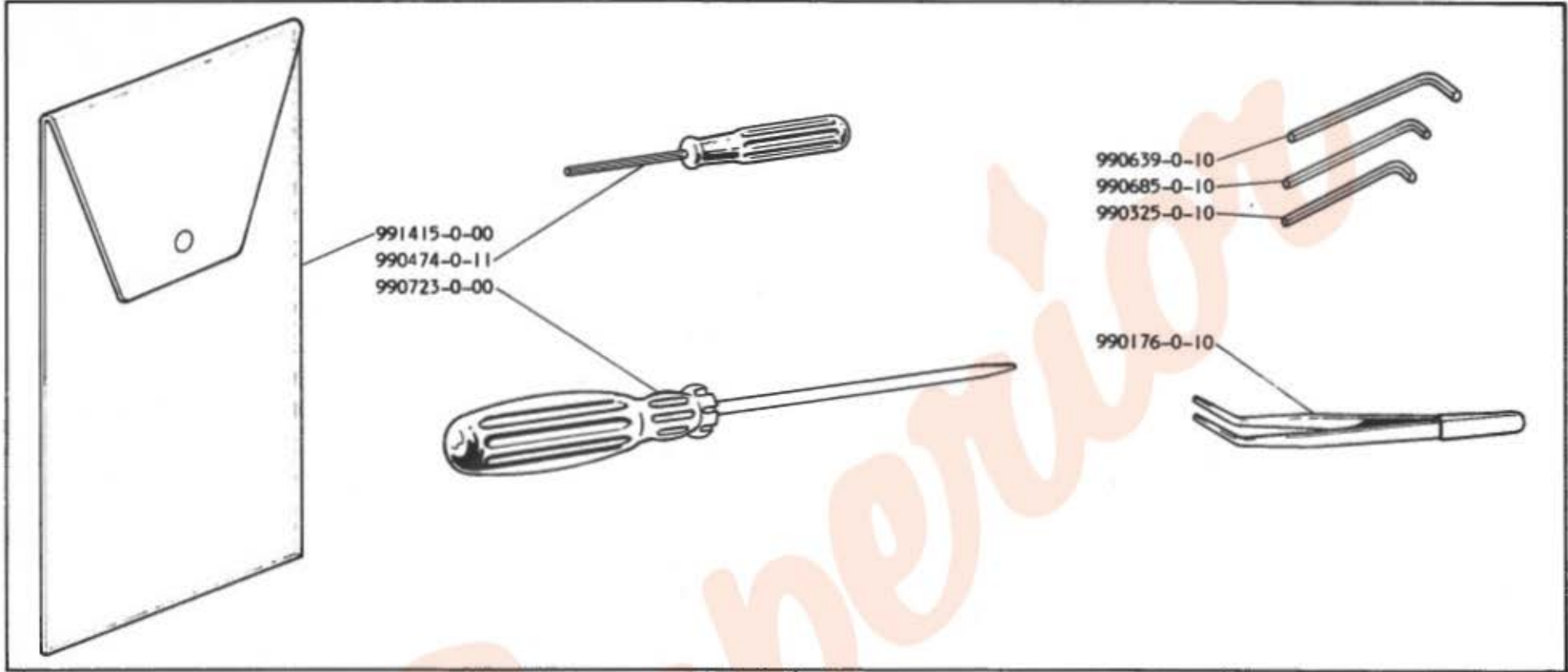

★ per l'ordinazione della bustina citare lo stesso simbolo dell'ago montato sulla testa

to order packet of needles please specify symbol of needle fitted on machine

pour commander un sachet d'aiguille donner le symbol de l'aiguille montée sur la tête

PIAZZAMENTO NORMALE
NORMAL SETTING
PLACEMENT NORMAL

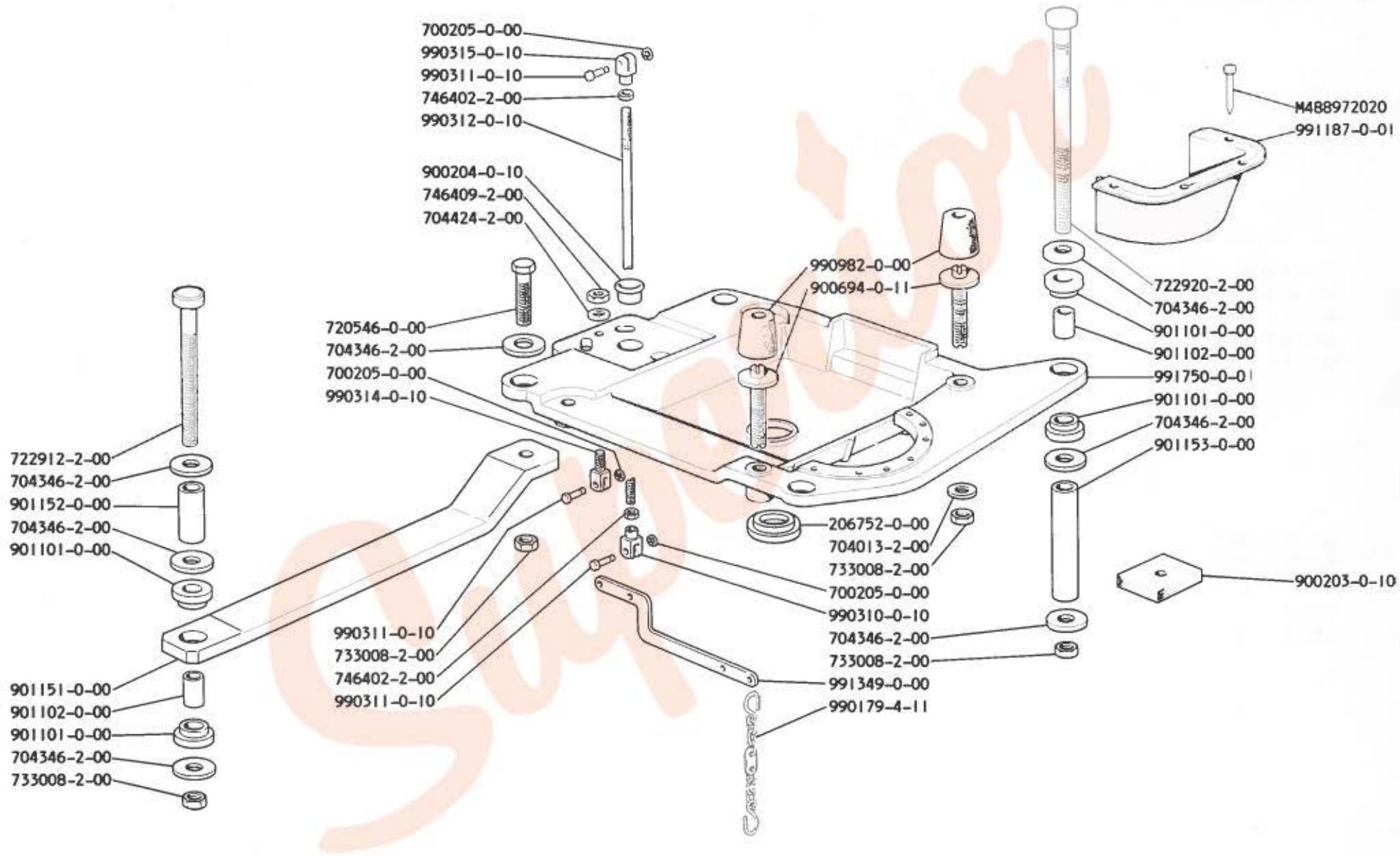



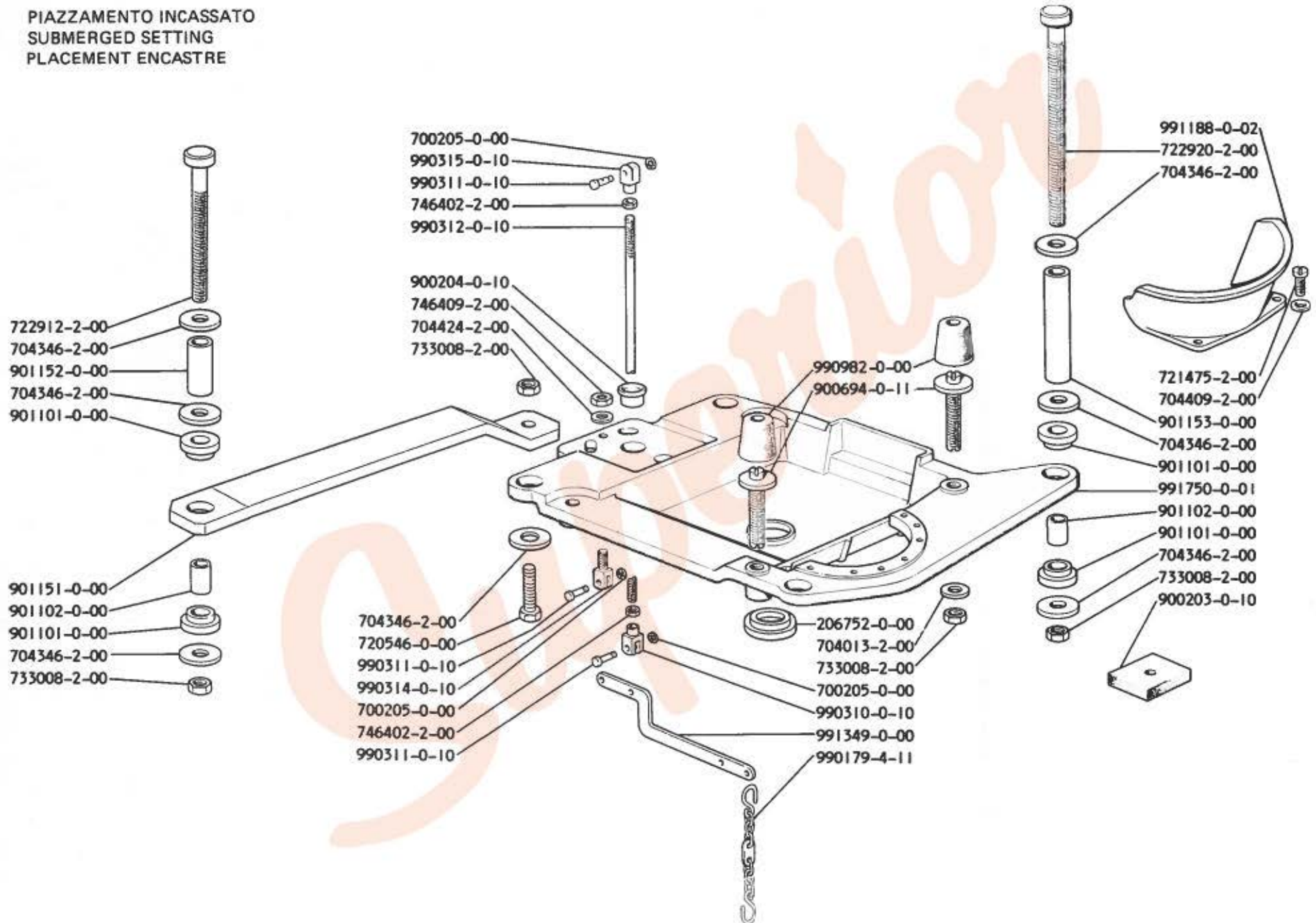

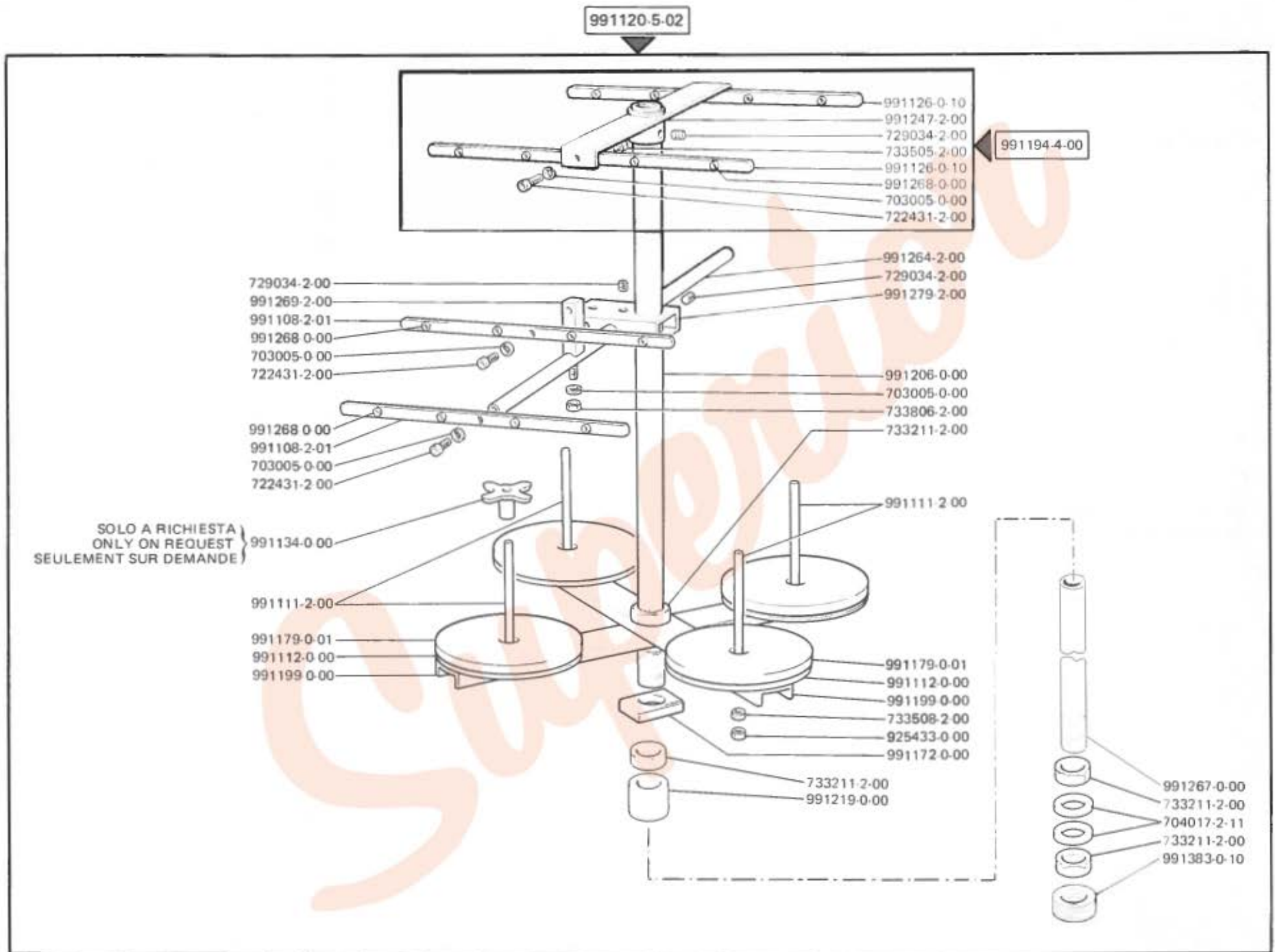

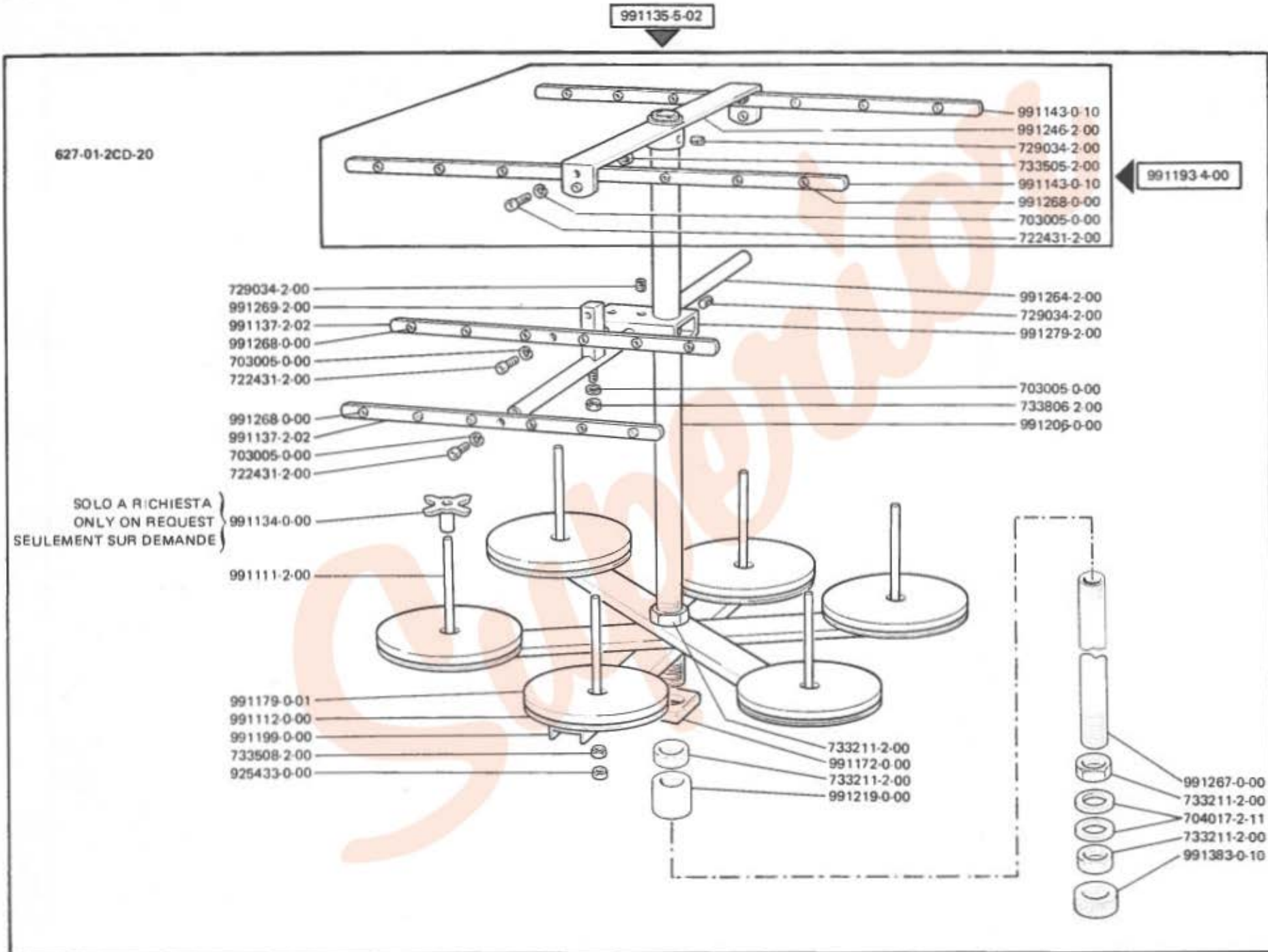

PIAZZAMENTO INCASSATO
 SUBMERGED SETTING
 PLACEMENT ENCASTRE



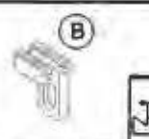
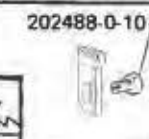
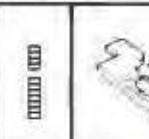
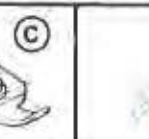
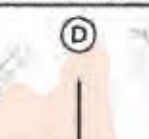

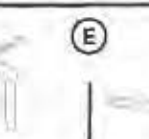

ORGANI DI CUCITURA				SEWING PARTS				ORGANES DE COUTURE											
R = A RICHIESTA G = GRIFFE GOMMATE ● ▲ ★ = ABBINAMENTI OBBLIGATORI				R = ON REQUEST G = RUBBERED FEED DOGS ● ▲ ★ = FIXED COUPLINGS				R = SUR DEMANDE G = GRIFFES CAOUTCHOUTEES ● ▲ ★ = JUMELAGES OBLIGES											
																			
627-00-1CD-01	202504-0-11		4,1	202053-0-10	1,5	202057-0-10	1,5	202061-0-10		202171-3-12		202142-0-10		202146-0-10		209265-0-00	209211-0-00		
	202148-0-11	R	4,6	202517-0-00	R	202559-0-00	R			202172-3-11	R	202143-0-10	R	207015-2-00	R				
	202507-0-11	R	5							202509-3-11	R	207000-2-00	R						
	202508-0-11	R	5,6	202056-2-11★	R	G	202060-2-11★	R	G			207008-2-00	R						
	202590-0-11	R	6	202757-0-00▲	R	1,5	202758-0-00▲	R	1,5										
	202506-4-11●	R	4,1							202173-3-11●	R								
627-00-1CD-02	202707-0-11		2	202605-0-10		1,5	202608-0-10		1,5	202609-0-10		202642-3-11		207000-2-00		207015-2-00		209264-0-00	209248-0-00
	202634-0-11	R	2,5	202695-0-10	R	1	202699-0-10	R	1			202717-3-11	R	202142-0-10	R	202146-0-10	R		
	202635-0-11	R	3,5									202644-3-11	R	202143-0-10	R				
	202709-0-11	R	1,5									202643-3-11▲	R	207008-2-00	R				
	202716-0-11	R	3									202732-3-01●	R						
	202636-0-11▲	R	1,2																
	202738-4-01●	R	3,5																
627-00-1CD-06	203785-0-11		5	203028-0-10		1,5	203031-0-10		1,5	203003-0-10		203015-3-11		202932-0-10		203012-0-10		209265-0-00	209213-0-00
	203761-0-11	R	6	203001-0-10	R	2	203002-0-10	R	2					207001-2-00	R	207016-2-00	R		
	203787-0-11	R	4	207027-0-00	R	1	207028-0-00	R	1										
				203030-2-11★	R	G	203033-2-11★	R	G										
627-00-1CD-07	203214-0-11		3,3	203199-0-10		1,5	202057-0-10		1,5	202061-0-10		202171-3-12		202142-0-10		202146-0-10		209264-0-00	209248-0-00
	203217-0-11	R	3,8									202172-3-11	R	202143-0-10	R	207015-2-00	R		
	203218-0-11	R	5									202509-3-11	R	207000-2-00	R				
	203220-0-11	R	2,8	203201-2-11★	R	G	202060-2-11★	R	G			202173-3-11●	R	207008-2-00	R				
	203216-4-11●	R	3,3																
627-00-1CD-09	203409-4-02		2	203335-2-11		G	203094-2-00		G	202061-0-10		203362-3-11		207000-2-00		207015-2-00		209264-0-00	209248-0-00
	203347-2-11	R	1,2									203360-3-11	R	202142-0-10	R	202146-0-10	R		
	203349-2-11	R	1,4									203361-3-11	R	202143-0-10	R				
											205940-3-01	R	207008-2-00	R					
627-00-1CD-20	202504-0-11		4,1	207077-0-00		1,5	207079-0-00		1,5	202061-0-10		202171-3-12		202143-0-10		202146-0-10		209265-0-00	209211-0-00
	202148-0-11	R	4,6											202142-0-10	R				
	202507-0-11	R	5																
	202508-0-11	R	5,6																
	202590-0-11	R	6																

ORGANI DI CUCITURA

SEWING PARTS

ORGANES DE COUTURE

R = A RICHIESTA
G = GRIFFE GOMMATE
● ▲ ★ = ABBINAMENTI OBBLIGATORI











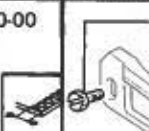
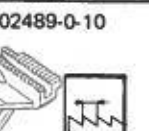
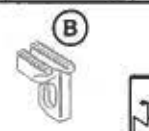
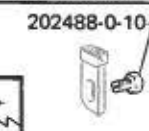
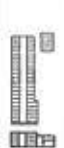

R = ON REQUEST
G = RUBBERED FEED DOGS
● ▲ ★ = FIXED COUPLINGS

R = SUR DEMANDE
G = GRIFFES CAOUTCHOUTEES
● ▲ ★ = JUMELAGES OBLIGES

	744742-0-00		202489-0-10		202488-0-10			208365-3-00		207001-2-00		209264-0-00		209248-0-00					
	A		B		C			D		E		F		G					
627-00-1CD-21	203035-0-12 203014-0-12 203037-0-12	R R	4,5 6,5 3,1	203028-0-10 203001-0-10 207027-0-00 203030-2-11★	R R R	1,5 2 1 G	203031-0-10 203002-0-10 207028-0-00 203033-2-11★	R R R	1,5 2 1 G	203004-0-10		207016-2-00 203012-0-10	R						
627-00-1CD-25	203047-0-21 203048-0-21	R	3 3,5	203060-0-10 203095-2-00★	R	1,5 G	203062-0-10 203094-2-00★	R	1,5 G	202609-0-10		203050-3-11 207100-3-01	R	207006-2-00 203066-0-10	R	207024-2-00 203144-0-10	R	209264-0-00	209248-0-00
627-00-1CD-26	203072-0-11		2	203060-0-10 203095-2-00★	R	1,5 G	203062-0-10 203094-2-00★	R	1,5 G	202061-0-10		203077-3-11		203066-0-10 207006-2-00	R	203069-0-10 207017-2-00	R	209264-0-00	209248-0-00
627-00-1CD-29	203813-0-11		5	203060-0-10 203095-2-00★	R	1,5 G	203062-0-10 203094-2-00★	R	1,5 G	202061-0-10		203815-3-11		202142-0-10 207000-2-00	R	203069-0-10 207017-2-00	R	209264-0-00	209248-0-00
627-00-1CD-30	203035-0-12 203014-0-12 203037-0-12	R R	4,5 6,5 3,1	203028-0-10 203001-0-10 207027-0-00 203030-2-11★	R R R	1,5 2 1 G	203031-0-10 203002-0-10 207028-0-00 203033-2-11★	R R R	1,5 2 1 G	203004-0-10		207076-3-01		207001-2-00		207016-2-00 203012-0-10	R	209264-0-00	209248-0-00
627-00-1CD-31	203219-0-11		3,8	203199-0-10 203201-2-11★	R R	1,5 G	202057-0-10 202060-2-11★	R R	1,5 G	202609-0-10		203162-3-11		207000-2-00 202142-0-10 202143-0-10 207008-2-00	R R R	207015-2-00 202146-0-10	R	209264-0-00	209248-0-00

ORGANI DI CUCITURA			SEWING PARTS			ORGANES DE COUTURE						
R = A RICHIESTA G = GRIFFE GOMMATE ● ▲ ★ = ABBINAMENTI OBBLIGATORI			R = ON REQUEST G = RUBBERED FEED DOGS ● ▲ ★ = FIXED COUPLINGS			R = SUR DEMANDE G = GRIFFES CAOUTCHOUTÉES ● ▲ ★ = JUMELAGES OBLIGES						
627-00-1MD-23	203761-0-11 203762-0-11 203785-0-11 203787-0-11 203788-0-11	6 R 7,5 R 5 R 4 R 7	203001-0-10 203028-0-10 207027-0-00 203030-2-11★	2 R 1,5 R 1 R G	203002-0-10 203031-0-10 207028-0-00 203033-2-11★	2 R 1,5 R 1 R G	203003-0-10	203765-3-11	203759-0-10 203783-0-10 207003-2-00 207004-2-00	R 203012-0-10 R 207016-2-00	209265-0-00	209213-0-00
627-00-1MD-33	203014-0-12 203035-0-12 203037-0-12	6,5 R 4,5 R 3,1	203001-0-10 203028-0-10 207027-0-00 203030-2-11★	2 R 1,5 R 1 R G	203002-0-10 203031-0-10 207028-0-00 203033-2-11★	2 R 1,5 R 1 R G	203004-0-10	203017-3-11	207004-2-00 203759-0-10 203783-0-10 207003-2-00	R 207016-2-00	209264-0-00	209248-0-00
627-01-1CD-02	202504-0-11 202148-0-11 202507-0-11 202508-0-11 202590-0-11	4,1 R 4,6 R 5 R 5,6 R 6	202053-0-10 202517-0-00 202056-2-11★ 202757-0-00▲	1,5 R 1 R G R 1,5	202057-0-10 202559-0-00 202060-2-11★ 202758-0-00▲	1,5 R 1 R G R 1,5	202061-0-10	202178-3-11	202142-0-10 202143-0-10 207000-2-00 207008-2-00	R 202146-0-10 R 207015-2-00	209265-0-00	209213-0-00
627-01-1CD-03	203785-0-11 203761-0-11 203787-0-11	5 R 6 R 4	203028-0-10 203001-0-10 207027-0-00 203030-2-11★	1,5 R 2 R 1 R G	203031-0-10 203002-0-10 207028-0-00 203033-2-11★	1,5 R 2 R 1 R G	203003-0-10	203016-3-11 203042-3-11	202932-0-10 207001-2-00	R 203012-0-10 R 207016-2-00	209264-0-00	209248-0-00
627-01-1CD-04	203214-0-11 203217-0-11 203218-0-11 203220-0-11	3,3 R 3,8 R 5 R 2,8	203199-0-10 203201-2-11★	1,5 R G	202057-0-10 202060-2-11★	1,5 R G	202061-0-10	202178-3-11	202142-0-10 202143-0-10 207000-2-00 207008-2-00	R 202146-0-10 R 207015-2-00	209264-0-00	209248-0-00
627-01-1CD-05	203219-0-11	3,8	203199-0-10 203201-2-11★	1,5 R G	202057-0-10 202060-2-11★	1,5 R G	202609-0-10	202178-3-11	202142-0-10 202143-0-10 207000-2-00 207008-2-00	R 202146-0-10 R 207015-2-00	209264-0-00	209248-0-00







ORGANI DI CUCITURA		SEWING PARTS		ORGANES DE COUTURE					
H = A RICHIESTA G = GRIFFE GOMMATE ● ▲ ★ = ABBINAMENTI OBBLIGATORI		R = ON REQUEST G = RUBBERED FEED DOGS ● ▲ ★ = FIXED COUPLINGS		R = SUR DEMANDE G = GRIFFES CAOUTCHOUEES ● ▲ ★ = JUMELAGES OBLIGES					
744742-0-00 (A)		202489-0-10 (B)		202488-0-10 (C)		(D)		(E)	
627.01.1CD-09	203219-0-11 3,8	203199-0-10 1,5	202057-0-10 1,5	202609-0-10	205892-3-00	207000-2-00 202142-0-10 202143-0-10 207008-2-00	207015-2-00 202146-0-10	209264-0-00	209248-0-00
627.01-1MD-08	203761-0-11 R 6 203762-0-11 R 7,5 203785-0-11 R 5 203787-0-11 R 4 203788-0-11 R 7	203001-0-10 R 2 203028-0-10 R 1,5 207027-0-00 R 1 203030-2-11* R G	203002-0-10 R 2 203031-0-10 R 1,5 207028-0-00 R 1 203033-2-11* R G	203003-0-10	203766-3-11	203759-0-00 203783-0-10 207003-2-00 207004-2-00	203012-0-10 207016-2-00	209265-0-00	209213-0-00
627.10.1CD-06	202783-0-11 R 3,2 202876-0-11 R 3 202877-0-11 R 5 206297-0-01 R 3,2	202780-0-10 1,5	202782-0-10 1,5	202061-0-10	202786-3-11 206350-3-00	202142-0-10 202143-0-10 207000-2-00 207008-2-00	202146-0-10 207015-2-00	209264-0-00	209248-0-00 209247-0-00
627.22.1CD-01	203786-0-11 R 5 203763-0-10 R 6	203746-0-10 1,5	203747-0-10 1,5	203003-0-10	203767-3-11 203765-3-11	202932-0-10 207001-2-00	203012-0-10 207016-2-00	209264-0-00	209248-0-00
627.22.1CD-02	203148-0-11 R 4,5 203149-0-11 R 5 203150-0-11 R 3,5 203280-0-11* R 2,5	203140-0-10 1,5	203141-0-11 1,5	202061-0-10	203157-3-11 203158-3-11 203159-3-11 203765-3-11	202142-0-10 202143-0-10 207000-2-00 207008-2-00	202146-0-10 207015-2-00	209264-0-00	209248-0-00
627.23.1CD-01	203786-0-11 R 5 203763-0-10 R 6	203746-0-10 1,5	203747-0-10 1,5	203003-0-10	203789-3-11 203733-3-11	202932-0-10 207001-2-00	203012-0-10 207016-2-00	209264-0-00	209248-0-00



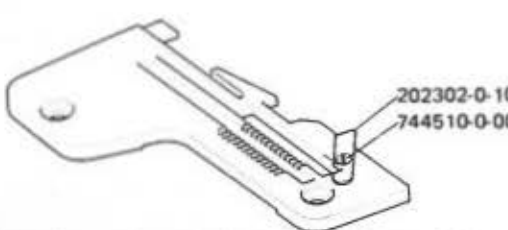
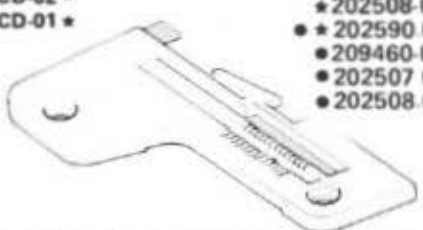
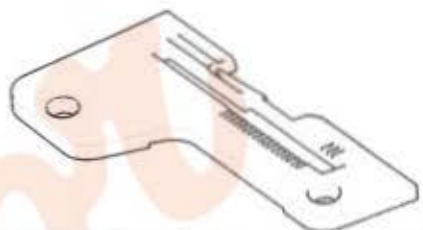

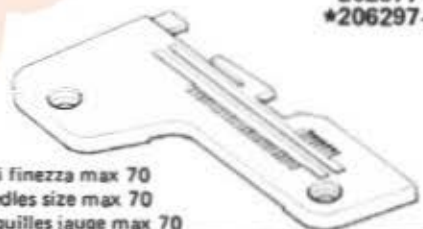
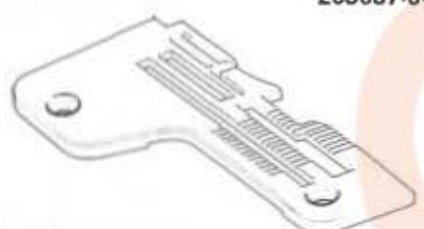
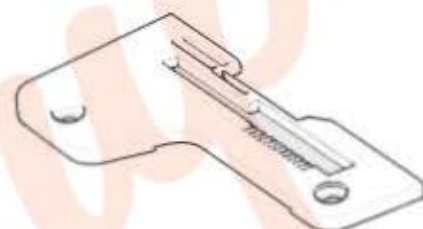
ORGANI DI CUCITURA		SEWING PARTS		ORGANES DE COUTURE								
R = A RICHIESTA G = GRIFFE GOMMATE ● ▲ ★ = ABBINAMENTI OBBLIGATORI		R=ON REQUEST G=RUBBERED FEED DOGS ● ▲ ★=FIXED COUPLINGS		R= SUR DEMANDE G=GRIFFES CAOUTCHOUTEES ● ▲ ★=JUMELAGES OBLIGES								
												
627-23-1CD-02	203148-0-11 203149-0-11 R	4,5 5	203140-0-10 1,5	203141-0-11 1,5	202061-0-10 	203160-3-11 	202142-0-10 202143-0-10 207000-2-00 207008-2-00 R	202146-0-10 207015-2-00 R	209264-0-00 R	209248-0-00		
627-28-1CD-02	209460-0-00 202507-0-11 202508-0-11 202590-0-11 R	5 4,1 4,6 6 R	202053-0-10 202517-0-00 R	1,5 1	202057-0-10 202559-0-00 R	1,5 1	202061-0-10 	202774-3-11 	207000-2-00 202142-0-10 202143-0-10 207008-2-00 R	207015-2-00 202146-0-10 R	209264-0-00 R	209247-0-00 209248-0-00 R
627-28-1CD-07	203354-4-12	1,3	203335-2-11 G	203094-2-00 G	202609-0-10 	203361-3-11 	207000-2-00 202142-0-10 202143-0-10 207008-2-00 R	207015-2-00 202146-0-10 R	209264-0-00 R	209248-0-00		
627-28-1CD-09	202636-0-11	1,2	202605-0-10 202695-0-10 R	1,5 1	202608-0-10 202699-0-10 R	1,5 1	202609-0-10 	202643-3-11 	207000-2-00 202142-0-10 202143-0-10 207008-2-00 R	207015-2-00 202146-0-10 R	209264-0-00 R	209248-0-00
627-28-1CD-12	203354-4-12	1,3	202604-0-10 203332-0-10 R	1 1,5	202607-0-10 203062-0-10 R	1 1,5	202609-0-10 	207100-3-01 	203066-0-10 207006-2-00 R	207011-0-00 207010-2-00 R	209264-0-00 R	209248-0-00
627-29-1CD-02	202504-0-11 202148-0-11 202507-0-11 202508-0-11 202590-0-11 R	4,1 4,6 5 5,6 6 R	202053-0-10 202517-0-00 R	1,5 1	202057-0-10 202559-0-00 R	1,5 1	202061-0-10 	202176-3-11 202175-3-12 R	203066-0-10 207006-2-00 R	202146-0-10 207015-2-00 R	209265-0-00 R	209248-0-00

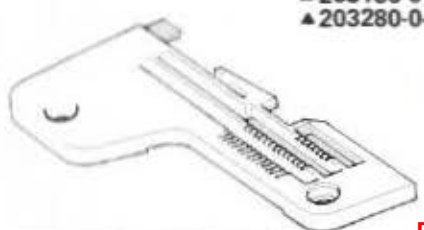
ORGANI DI CUCITURA				SEWING PARTS				ORGANES DE COUTURE					
R = A RICHIESTA G = GRIFFE GOMMATE ● ▲ ★ = ABBINAMENTI OBBLIGATORI				R = ON REQUEST G = RUBBERED FEED DOGS ● ▲ ★ = FIXED COUPLINGS				R = SUR DEMANDE G = GRIFFES CAOUTCHOUTEES ● ▲ ★ = JUMELAGES OBLIGES					
627-29-1CD-05	203214-0-11 203217-0-11 R 203218-0-11 R 203220-0-11 R	3,3 3,8 5 2,8	203199-0-10 203201-2-11★ R	1,5 G	202057-0-10 202060-2-11★ R	1,5 G	202061-0-10 	202175-3-12 202176-3-11 R	203066-0-10 207006-2-00 R	202146-0-10 207015-2-00 R	209264-0-00 R	209248-0-00 R	
627-30-1CD-07	203219-0-11	3,8	206951-0-00	1,5	205952-0-01	1,5	202609-0-10	205954-3-01	207000-2-00 202142-0-10 202143-0-10 207008-2-00	207015-2-00 202146-0-10 R	209264-0-00 R	209248-0-00	
627-34-1CD-01	202504-0-11 202148-0-11 R 202507-0-11 R 202508-0-11 R 202590-0-11 R	4,1 4,6 5 5,6 6	202542-0-10	1,5	203265-0-11	1,5	202061-0-10	206140-3-02	202142-0-10 202143-0-10 207000-2-00 207008-2-00	202146-0-10 207015-2-00 R	209264-0-00 R	209248-0-00	
627-34-1MD-03	205597-0-01	6,5	203001-0-10 203028-0-10 R 207027-0-00 R	2 1,5 1	203002-0-10 203031-0-10 R 207028-0-00 R	2 1,5 1	203004-0-10	205595-3-11	207004-2-00 203759-0-10 203783-0-10 207003-2-00	207016-2-00 203012-0-10 R	209265-0-00 R	209247-0-00	
627-38-1CD-01	203219-0-11	3,8	203199-0-10	1,5	202057-0-10	1,5	202609-0-10	203162-3-11	207000-2-00	207015-2-00	209264-0-00	209248-0-00	
627-49-1MD-01	204066-0-11	8	204061-0-10	2	204062-0-10	2	203003-0-10	205604-3-01 205607-3-01 R 206157-3-01 R	207003-2-00	207016-2-00 203012-0-10 R	209264-0-00	209248-0-00	

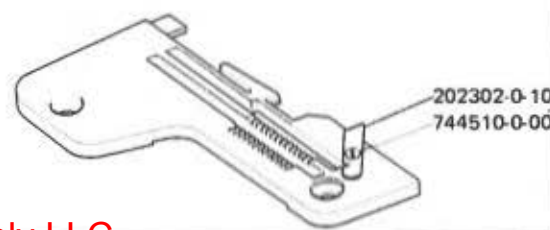
ORGANI DI CUCITURA				SEWING PARTS				ORGANES DE COUTURE																																	
R = A RICHIESTA G = GRIFFE GOMMATE ● ▲ ★ = ABBINAMENTI OBBLIGATORI				R = ON REQUEST G = RUBBERED FEED DOGS ● ▲ ★ = FIXED COUPLINGS				R = SUR DEMANDE G = GRIFFES CAOUTCHOUTEES ● ▲ ★ = JUMELAGES OBLIGES																																	
627-49-1MD-03	207746-0-00	8	207745-0-00	1,5	207744-0-00	1,5	202061-0-10		207743-3-00	203759-0-10		203012-0-10	R	207016-2-00	R																										
PARTICOLARI A RICHIESTA PER ESEGUIRE LA SURFILATURA DI STROFINACCI LEGGERI CON RISVOLTO VERSO L'ALTO PARTS ON REQUEST FOR SERGING LIGHT FLOOR-CLOTHS WITH THE EDGE CURLED OVER INSIDE THE SEAM SUR DEMANDE PIÈCES POUR EXÉCUTER LE SURFILAGE DE SERPILLIÈRES LEGÈRES AVEC REPLI VERS LE HAUT																																									
627-00-1CD-30	207148-0-01	3,1							207147-3-01	207006-2-00		207017-2-00								207586-0-00																					

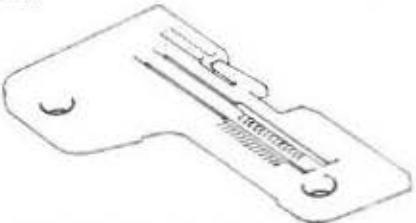
TAV. 24

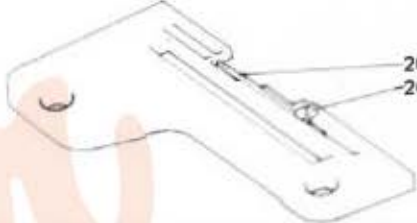
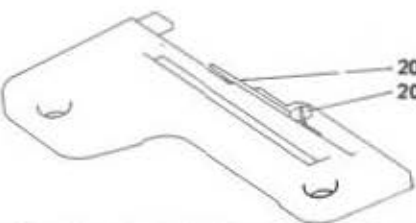
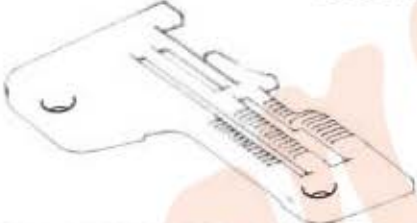
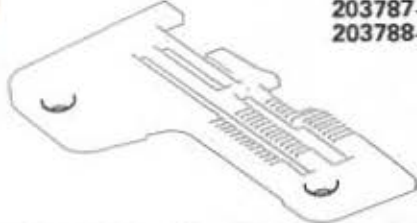

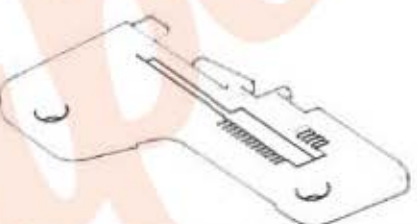
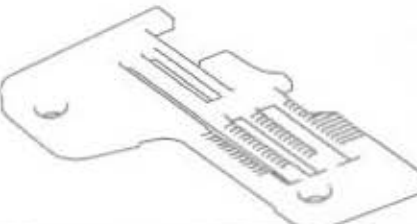
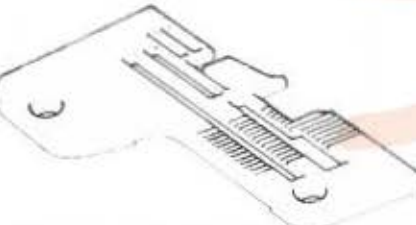
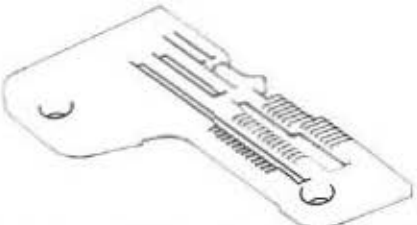
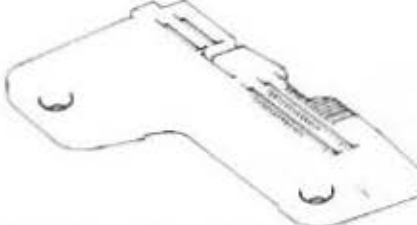





<p>627-00-1CD-01</p> <p>202506-4-11 4,1</p> 	<p>627-00-1CD-01* 627-00-1CD-20* 627-01-1CD-02* 627-28-1CD-02* 627-29-1CD-02* 627-34-1CD-01*</p> <p>★202148 0-11 4,6 ★202504-0-11 4,1 ★202507-0-11 5 ★202508-0-11 5,6 ●★202590 0-11 6 ●209460-0-00 5 ●202507 0-11 4,1 ●202508 0-11 4,6</p> 	<p>627-00-1CD-02 627-28-1CD-09</p> <p>202636-0-11 1,2</p> 
<p>627-00-1CD-02</p> <p>202634-0-11 2,5 202635-0-11 3,5 202707-0-11 2 202709-0-11 1,5 202716-0-11 3</p> 	<p>627-00-1CD-02</p> <p>202738-4-01 3,5</p> 	<p>627-10-1CD-06</p> <p>202783-0-11 3,2 202876-0-11 3 202877-0-11 5 ★206297-0-01 3,2</p> <p>★ Per aghi finezza max 70 ★ For needles size max 70 ★ Pour aiguilles jauge max 70</p> 
<p>627-00-1CD-21 627-00-1CD-30 627-00-1MD-33</p> <p>203014-0-12 6,5 203035-0-12 4,5 203037-0-12 3,1</p> 	<p>627-00-1CD-25</p> <p>203047-0-21 3 203048-0-21 3,5</p> 	<p>627-00-1CD-26</p> <p>203072-0-11 2</p> 
<p>627-22-1CD-02 ▲ 627-23-1CD-02 ●</p> <p>▲ 203148-0-11 4,5 ▲ 203149-0-11 5 ▲ 203150-0-11 3,5 ▲ 203280-0-11 2,5</p> 	<p>627-00-1CD-07 627-01-1CD-04 627-29-1CD-05</p> <p>203214-0-11 3,3 203217-0-11 3,8 203218-0-11 5 203220-0-11 2,8</p> 	<p>627-00-1CD-07</p> <p>203216-4-11 3,3</p> 

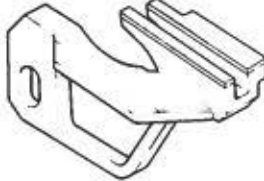
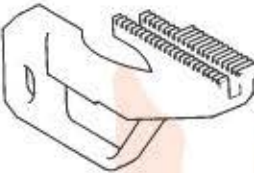
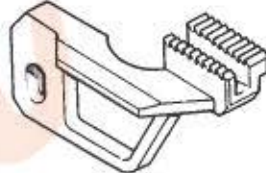

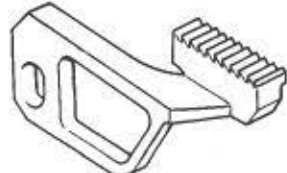

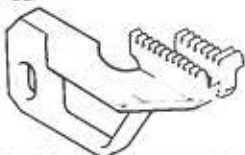

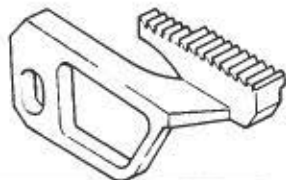
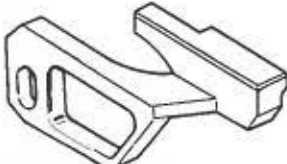
<p>627-00-1CD-31 627-01-1CD-05 627-01-1CD-09 627-30-1CD-07 627-38-1CD-01</p> <p>203219-0-11 3,8</p> 	<p>627-00-1CD-09</p> <p>203347-2-11 1,2 203349-2-11 1,4</p> 	<p>627-28-1CD-07 627-28-1CD-12</p> <p>203354-4-12 1,3</p> <p>203357-0-10 203382-0-10</p> 
<p>627-00-1CD-09</p> <p>203409-4-02 2</p> <p>203357-0-10 203382-0-10</p> 	<p>627-00-1CD-06 627-01-1CD-03</p> <p>203761-0-11 6 203785-0-11 5 203787-0-11 4</p> 	<p>627-00-1MD-23 627-01-1MD-08</p> <p>203761-0-11 6 203762-0-11 7,5 203785-0-11 5 203787-0-11 4 203788-0-11 7</p> 
<p>627-22-1CD-01 627-23-1CD-01</p> <p>203763-0-11 6 203786-0-11 5</p> 	<p>627-00-1CD-29</p> <p>203813-0-11 5</p> 	<p>627-49-1MD-01</p> <p>204066-0-11 8</p> 
<p>627-34-1MD-03</p> <p>205597-0-01 6,5</p> 	<p>627-00-1CD-30</p> <p>207148-0-01 3,1</p> 	<p>627-49-1MD-03</p> <p>207746-0-00 8</p> 

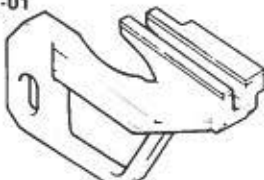
744742-0-00 Vite per placca ago

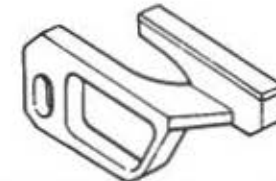
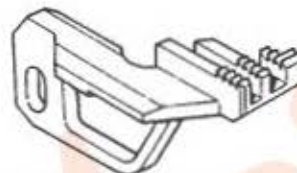
744742-0-00 Screw for needle plate

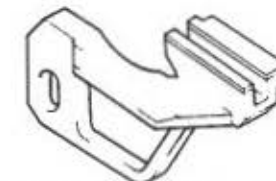
744742-0-00 Vis pour plaque-aiguille

<p>627-00-1CD-01 627-01-1CD-02 627-28-1CD-02 627-29-1CD-02</p> <p>202053-0-10</p> 	<p>627-00-1CD-01 627-01-1CD-02 627-28-1CD-02 627-29-1CD-02</p> <p>202056-2-11</p> 	<p>627-00-1CD-01 627-01-1CD-02 627-28-1CD-02 627-29-1CD-02</p> <p>202517-0-00</p> 	<p>627-34-1CD-01</p> <p>202542-0-10</p> 
<p>627-28-1CD-12</p> <p>202604-0-10 203332-0-10</p> 	<p>627-00-1CD-02 627-28-1CD-09</p> <p>202605-0-10 202695-0-10</p> 	<p>627-00-1CD-01 627-01-1CD-02 627-28-1CD-02 627-29-1CD-02</p> <p>202757-0-00</p> 	<p>627-10-1CD-06</p> <p>202780-0-10</p> 
<p>627-00-1CD-06 627-00-1CD-21 627-00-1CD-30 627-00-1MD-23 627-00-1MD-33 627-01-1CD-03 627-01-1MD-08 627-34-1MD-03</p> <p>203001-0-10</p> 	<p>627-00-1CD-06 627-00-1CD-21 627-00-1CD-30 627-00-1MD-23 627-00-1MD-33 627-01-1CD-03 627-01-1MD-08 627-34-1MD-03</p> <p>203028-0-10</p> 	<p>627-00-1CD-06 627-00-1CD-21 627-00-1CD-30 627-00-1MD-23 627-00-1MD-33 627-01-1CD-03 627-01-1MD-08 627-34-1MD-03</p> <p>203030-2-11</p> 	<p>627-00-1CD-25 627-00-1CD-26 627-00-1CD-29</p> <p>203060-0-10</p> 
<p>627-00-1CD-25 627-00-1CD-26 627-00-1CD-29</p> <p>203095-2-00</p> 	<p>627-22-1CD-02 627-23-1CD-02</p> <p>203140-0-10</p> 	<p>627-00-1CD-07 627-00-1CD-31 627-01-1CD-04 627-01-1CD-05 627-01-1CD-09 627-29-1CD-05 627-38-1CD-01</p> <p>203199-0-10</p> 	<p>627-00-1CD-07 627-00-1CD-31 627-01-1CD-04 627-01-1CD-05 627-01-1CD-09 627-29-1CD-05 627-38-1CD-01</p> <p>203201-2-11</p> 













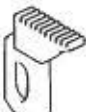

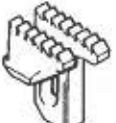
<p>627-22-1CD-02</p> <p>203270-0-10 1</p> 	<p>627-00-1CD-09 627-28-1CD-07</p> <p>203335-2-11</p> 	<p>627-22-1CD-01 627-23-1CD-01</p> <p>203746-0-10 1,5</p> 	<p>627-49-1MD-01</p> <p>204061-0-10 2</p> 
<p>627-30-1CD-07</p> <p>205951-0-00 1,5</p> 	<p>627-30-1CD-07</p> <p>206293-2-00</p> 	<p>627-00-1CD-06 627-00-1CD-21 627-00-1CD-30 627-00-1MD-23 627-00-1MD-33 627-01-1CD-03 627-01-1MD-08 627-34-1MD-03</p> <p>207027-0-00 1</p> 	<p>627-00-1CD-20</p> <p>207077-0-00 1,5</p> 
<p>627-49-1MD-03</p> <p>207745-0-00 1,5</p> 			



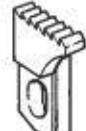

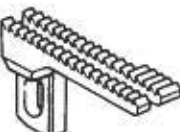





202489-0-10 Vite per griffa principale

202489-0-10 Main feed dog screw

202489-0-10 Vis pour griffe principale

TAV. 28

<p>627-00-1CD-01 627-00-1CD-07 627-00-1CD-31 627-01-1CD-02 627-01-1CD-04 627-01-1CD-05 627-01-1CD-09 627-28-1CD-02 627-29-1CD-02 627-29-1CD-05 627-38-1CD-01</p> <p>202057-0-10</p>  <p>1,5</p>	<p>627-00-1CD-01 627-00-1CD-07 627-00-1CD-31 627-01-1CD-02 627-01-1CD-04 627-01-1CD-05 627-01-1CD-09 627-28-1CD-02 627-29-1CD-02 627-29-1CD-05 627-38-1CD-01</p> <p>202060-2-11</p> 	<p>627-00-1CD-01 627-01-1CD-02 627-28-1CD-02 627-29-1CD-02</p> <p>202559-0-00</p>  <p>1</p>	<p>627-28-1CD-12</p> <p>202607-0-10</p>  <p>1</p>
<p>627-00-1CD-02 627-28-1CD-09</p> <p>202608-0-10 202699-0-10</p>  <p>1,5 1</p>	<p>627-00-1CD-01 627-01-1CD-02 627-28-1CD-02 627-29-1CD-02</p> <p>202758-0-00</p>  <p>1,5</p> <p>Cromatura dura Hard chromium plating Cromage dur</p>	<p>627-10-1CD-06</p> <p>202782-0-10</p>  <p>1,5</p>	<p>627-00-1CD-06 627-00-1CD-21 627-00-1CD-30 627-00-1MD-23 627-00-1MD-33 627-01-1CD-03 627-01-1MD-08 627-34-1MD-03</p> <p>203002-0-10</p>  <p>2</p>
<p>627-00-1CD-06 627-00-1CD-21 627-00-1CD-30 627-00-1MD-23 627-00-1MD-33 627-01-1CD-03 627-01-1MD-08 627-34-1MD-03</p> <p>203031-0-10</p>  <p>1,5</p>	<p>627-00-1CD-06 627-00-1CD-21 627-00-1CD-30 627-00-1MD-23 627-00-1MD-33 627-01-1CD-03 627-01-1MD-08 627-34-1MD-03</p> <p>203033-2-11</p> 	<p>627-00-1CD-25 627-00-1CD-26 627-00-1CD-29 627-28-1CD-12</p> <p>203062-0-10</p>  <p>1,5</p>	<p>627-00-1CD-09 627-00-1CD-25 627-00-1CD-26 627-00-1CD-29 627-28-1CD-07</p> <p>203094-2-00</p> 
<p>627-22-1CD-02 627-23-1CD-02</p> <p>203141-0-11</p>  <p>1,5</p>	<p>627-34-1CD-01</p> <p>203265-0-11</p>  <p>1,5</p>	<p>627-22-1CD-01 627-23-1CD-01</p> <p>203747-0-10</p>  <p>1,5</p>	<p>627-49-1MD-01</p> <p>204062-0-10</p>  <p>2</p>

<p>627-30-1CD-07</p> <p>205952-0-01 1,5</p> 	<p>627-30-1CD-07</p> <p>206295-2-01</p> 	<p>627-00-1CD-06 627-00-1CD-21 627-00-1CD-30 627-00-1MD-23 627-00-1MD-33 627-01-1CD-03 627-01-1MD-08 627-34-1MD-03</p> <p>207028-0-00 1</p> 	<p>627-00-1CD-20</p> <p>207079-0-00 1,5</p> 
<p>627-49-1MD-03</p> <p>207744-0-00 1,5</p> 	<p>627-22-1CD-02</p> <p>203271-0-11 1</p> 		
<p>202061-0-10</p> <p>627-00-1CD-01 627-01-1CD-02 627-29-1CD-02 627-00-1CD-07 627-01-1CD-04 627-29-1CD-05 627-00-1CD-09 627-10-1CD-06 627-34-1CD-01 627-00-1CD-20 627-22-1CD-02 627-49-1MD-03 627-00-1CD-26 627-23-1CD-02 627-00-1CD-29 627-28-1CD-02</p> 	<p>202609-0-10</p> <p>627-00-1CD-02 627-28-1CD-07 627-00-1CD-25 627-28-1CD-09 627-00-1CD-31 627-28-1CD-12 627-01-1CD-05 627-30-1CD-07 627-01-1CD-09 627-38-1CD-01</p> 	<p>203003-0-10</p> <p>627-00-1CD-06 627-22-1CD-01 627-00-1MD-23 627-23-1CD-01 627-01-1CD-03 627-49-1MD-01 627-01-1MD-08</p> 	<p>203004-0-10</p> <p>627-00-1CD-21 627-00-1CD-30 627-00-1MD-33 627-34-1MD-03</p> 

<p>202171-3-12</p> <p>627-00-1CD-01 627-00-1CD-07 627-00-1CD-20</p> <p>Assemblaggi tessuti medi-leggeri Light and medium weight fabrics assembly Assemblages tissus moyens et légers</p>	<p>202172-3-11</p> <p>627-00-1CD-01 627-00-1CD-07</p> <p>Assemblaggi tessuti scivolosi Slippery fabrics assembly Assemblages tissus glissants</p>	<p>202173-3-11</p> <p>627-00-1CD-01 627-00-1CD-07</p> <p>Assemblaggi tessuti medi, leggeri per evitare il risvolto del tessuto Medium and light weight fabric assembly to avoid fabric turning Assemblages tissus moyens, légers pour éviter le repli du tissu</p>	<p>202175-3-12</p> <p>627-29-1CD-02 627-29-1CD-05</p> <p>Surfilatura con inserimento di elastico Ø 1 mm For serging operation with insertion of elastic Ø 1 mm Surfilage avec insertion d'élastique Ø 1 mm</p>
<p>202176-3-11</p> <p>627-29-1CD-02 627-29-1CD-05</p> <p>Surfilatura con inserimento di elastico piatto max 4 mm For serging operation with insertion of flat elastic mm 4 max width Surfilage avec insertion d'élastique plat max 4 mm</p>	<p>202178-3-11</p> <p>627-01-1CD-02 627-01-1CD-04 627-01-1CD-05</p> <p>Assemblaggi con fettuccia di rinforzo max 8 mm Assembly with reinforcing tape max 8 mm Assemblages avec bande de renfort max 8 mm</p>	<p>202509-3-12</p> <p>627-00-1CD-01 627-00-1CD-07</p> <p>Piedino con tagliacatenella per assemblaggi di tessuti medi e leggeri Presserfoot with chain cutter for medium and light fabrics assembly Piéd presseur avec coupe-chainette pour assemblages de tissus moyens et légers</p>	<p>202642-3-11</p> <p>627-00-1CD-02</p> <p>Assemblaggi tessuti molto leggeri Very light fabrics assembly Assemblages tissus très légers</p>











<p>202643-3-11</p> <p>627-00-1CD-02 627-28-1CD-09</p> <p>Surfilatura tovaglie e tovaglioli For serging operation of table cloths and table napkins Surfilage nappes et serviettes</p>	<p>202644-3-11</p> <p>627-00-1CD-02</p> <p>Assemblaggio di tessuti indemagliabili Assembly seaming warp knit fabrics Couture d'assemblage des tissus indemallable</p>	<p>202717-3-11</p> <p>627-00-1CD-02</p> <p>Assemblaggi di tessuti indemagliabili (con piastrina guida tessuto) Assembly warp knit fabrics (with fabric edge guide) Assemblage tissus indemallable</p>	<p>202732-3-01</p> <p>627-00-1CD-02</p> <p>Assemblaggi tessuti molto leggeri per evitare il risvolto del tessuto Very light fabrics assembly to avoid fabric turning Assemblages tissus très légers pour éviter le repli du tissu</p>
<p>202774-3-11</p> <p>627-28-1CD-02</p> <p>Surfilatura in genere For serging operation in generally Surfilage en général</p>	<p>202786-3-11</p> <p>627-10-1CD-06</p> <p>Orlature punto invisibile su maglieria med'a e leggera in genere For blind stitch edging of medium and light knit fabrics Orlures point invisible pour bonneterie moyenne et légère</p>	<p>203015-3-11</p> <p>627-00-1CD-06</p> <p>Assemblaggi tessuti medi e pesanti Medium and heavy weight fabrics assembly Assemblages tissus moyens et lourdes</p>	<p>203016-3-11</p> <p>627-01-1CD-03</p> <p>Assemblaggi con fettuccia di rinforzo max 12 mm Assembly with reinforcing tape max 12 mm Assemblages avec bande de renfort max 12 mm</p>









<p>203017-3-11</p> <p>627-00-1MD-33</p> <p>741413-0-10 203025-0-10 741685-2-00 203768-0-12 203772-0-11 203026-0-11</p> <p>Assemblaggio di tessuti pesanti Heavy weight fabrics assembly Assemblage tissus lourdes</p>	<p>203042-3-11</p> <p>627-01-1CD-03</p> <p>741413-2-00 202192-0-10 741665-2-00 202201-0-11 203044-0-11</p> <p>Assemblaggi con fettuccia di rinforzo max 8 mm Assembly with reinforcing tape max 8 mm Assemblages avec bande de renfort max 8 mm</p>	<p>203050-3-11</p> <p>627-00-1CD-25</p> <p>741665-2-00 202201-0-11 203052-0-11 741431-2-00 202184-0-11</p> <p>Assemblaggi di tessuti sfilacciabili Assembly of fabrics which fray Assemblages de tissus qui s'effilochent</p>	<p>203077-3-11</p> <p>627-00-1CD-26</p> <p>741413-2-00 202795-0-10 741665-2-00 202201-0-11 203079-2-11 203082-0-11</p> <p>Per tessuti tipo flanella con bordi sfilacciabili For type flannel fabrics with fraying hems Pour tissus type flanelle avec bords qui s'effilochent</p>
<p>203157-3-11</p> <p>627-22-1CD-02</p> <p>741413-2-00 202192-0-10 741665-2-00 202201-0-11 202195-0-11</p> <p>Assemblaggi con arricciatura di tessuti leggeri non sfilacciabili Assembly with gathering of light weight non-frayed fabrics Assemblages avec fronçage de tissus légers qui ne s'effilochent pas</p>	<p>203158-3-11</p> <p>627-22-1CD-02</p> <p>741413-2-00 202192-0-10 741665-2-00 202201-0-11 202195-0-11</p> <p>Assemblaggi con arricciatura di tessuti leggerissimi non sfilacciabili Assembly with gathering of very light weight, non frayed fabrics Assemblages avec fronçage des tissus très légers qui ne s'effilochent pas</p>	<p>203159-3-11</p> <p>627-22-1CD-02</p> <p>741413-2-00 202192-0-10 741665-2-00 202201-0-11 203173-0-11</p> <p>Assemblaggi con arricciatura di tessuti leggeri sfilacciabili Assembly with gathering of light fabrics wich fray easily Assemblages avec fronçage de tissus légers qui s'effilochent</p>	<p>203160-3-11</p> <p>627-23-1CD-02</p> <p>741413-2-00 202192-0-10 741665-2-00 202201-0-11 202195-0-11</p> <p>Assemblaggio con arricciatura di tessuti leggeri. Con inserimento di profilo Ø 1 mm. Assembly with gathering of light fabrics . With insertion of piping Ø 1 mm Assemblages avec fronçage de tissus légers. Avec insertion de passepoil Ø 1 mm.</p>

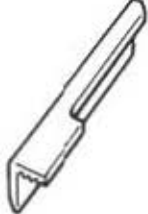

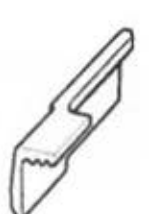

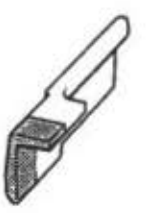

<p>203162-3-11</p> <p>627-00-1CD-31 627-38-1CD-01</p> <p>741413-2-00 203025-2-00</p> <p>741675-2-00 203772-0-11 741431-2-00 202195-0-11 202184-0-11</p> <p>Assemblaggi tessuti leggeri e medi Applicazione di bordini con profilo</p> <p>Light and medium weight fabrics assembly Application of binding with piping</p> <p>Assemblages tissus légers et moyens Application des bordures avec passepoil</p>	<p>203360-3-11</p> <p>627-00-1CD-09</p> <p>741675-2-00 203483-0-11 202201-0-11 203375-0-11 741431-2-00 202184-0-11</p> <p>Chiusura punta calze donna con risvolto piccolo</p> <p>Closing stocking toes</p> <p>Fermeture de la pointe des bas en nylon</p>	<p>203361-3-11</p> <p>627-00-1CD-09 627-28-1CD-07</p> <p>741675-2-00 203369-0-11 202201-0-11 203376-0-11 741431-2-00 202184-0-11</p> <p>Surfilatura di foulard Sergin of scarves Surfilage de foulards</p>	<p>203362-3-11</p> <p>627-00-1CD-09</p> <p>741665-2-00 202201-0-11 203377-0-11 741431-2-00 202184-0-11</p> <p>Chiusura punte calze da donna Closing stocking toes</p> <p>Fermeture de la pointe des bas en nylon</p>
<p>203765-3-11</p> <p>627-00-1MD-23 627-22-1CD-01 627-22-1CD-02</p> <p>741413-2-00 203025-2-00</p> <p>741685-2-00 203768-0-11 203772-0-11 203771-0-11</p> <p>Assemblaggio di tessuti pesanti Heavy weight fabrics assembly</p> <p>Assemblages tissus lourdes</p>	<p>203766-3-11</p> <p>627-01-1MD-08</p> <p>741413-2-00 203025-0-10</p> <p>741685-2-00 203768-0-11 203772-0-11 741519-2-00 203771-0-11 204020-0-11</p> <p>Assemblaggio con fettuccia di rinforzo max 12 mm Assembly with reinforcing tape max 12 mm</p> <p>Assemblages avec bande de renfort max 12 mm</p>	<p>203767-3-11</p> <p>627-22-1CD-01</p> <p>741685-2-00 203768-0-11 203772-0-11 203026-0-11</p> <p>Assemblaggi con arricciatura di tessuti medi non sfilacciabili</p> <p>Assembly with gathering of medium weight non frayed fabrics</p> <p>Assemblages avec fronçage de tissus moyens qui ne s'effilochent pas</p>	<p>203789-3-11</p> <p>629-23-1CD-01</p> <p>721454-2-00 203791-0-12 203571-0-11 203794-0-11</p> <p>Assemblaggio con arricciatura di tessuti medi. Con inserimento di profilo Ø 2 mm.</p> <p>Assembly with gathering of medium weight fabrics. With insertion of piping Ø 2 mm.</p> <p>Assemblages avec fronçage de tissus moyens. Avec insertion de passepoil Ø 2 mm.</p>









<p>203790-3-11</p> <p>627-23-1CD-01</p> <p>721444-2-00 203791-0-12 203571-0-11 203794-0-11</p> <p>Assemblaggi con arricciatura di tessuti medi. Con inserimento di profilo \varnothing 3 mm.</p> <p>Assembly with gathering of medium weight fabrics. With insertion of piping \varnothing 3 mm</p> <p>Assemblages avec fronçage de tissus moyens. Avec insertion de passepoil \varnothing 3 mm.</p>	<p>203815-3-11</p> <p>627-00-1CD-29</p> <p>741413-2-00 202795-0-10 741665-2-00 202201-0-11 203816-0-11 203817-0-11</p> <p>Per tessuti tipo spugna For type sponge fabrics Pour tissus type éponge</p>	<p>205595-3-11</p> <p>627-34-1MD-03</p> <p>741413-2-00 204052-0-10 741675-2-00 203772-0-11 202195-0-11 741453-2-00 205596-0-11</p> <p>Applicazione elastici a guaine e pancere. Application of elastic on corsetry garments Application des elastiques pour corseterie</p>	<p>205604-3-01</p> <p>627-49-1MD-01</p> <p>761675-2-00 204070-0-20 741453-2-00</p> <p>Applicazione rapporti dei pantaloni con inserimento chiusura lampo senza cursore Application of trousers fly facing with insertion of zipper without slider Application de les braguettes des pantalones avec insertion de la fermeture à glissière sans curseur</p>
<p>205607-3-01</p> <p>627-49-1MD-01</p> <p>741453-2-00 741685-2-00 204070-0-20</p> <p>Applicazione rapporti dei pantaloni con inserimento chiusura lampo senza cursore Application of trousers fly facing with insertion of zipper without slider Application de les braguettes des pantalones avec insertion de la fermeture à glissière sans curseur</p>	<p>205892-3-00</p> <p>627-01-1CD-09</p> <p>721424-2-00 203571-0-11</p> <p>Assemblaggi con inserimento profilo ornamentale Assembly with decorative piping Assemblages avec profil ornamental</p>	<p>205940-3-01</p> <p>627-00-1CD-09</p> <p>741675-2-00 203483-0-11 202201-0-11 203378-0-11 741431-2-00 202184-0-11</p> <p>Assemblaggio collant Assembly seams of panty-hose</p>	<p>205954-3-01</p> <p>627-30-1CD-07</p> <p>741675-2-00 203571-0-11</p> <p>Applicazione pizzi rigidi Applications of rigid lace Pour poser de dentelles rigides</p>

<p>206140-3-02</p> <p>627-34-1CD-01</p> <p>741413-2-00 203025-2-00 741685-2-00 203768-0-11 203772-0-11 721412-2-00 206142-0-01 206143-0-00</p> <p>Applicazione di elastici su tessuti medi e leggeri. Larghezza elastico da 6 a 16 mm Application of elastics on medium and light weight fabrics. Width of the elastic from 6 to 16 mm Pour poser des elastiques sur tissus moyens et legers, Largeur de l'elastique de 6 a 16 mm</p>	<p>206157-3-01</p> <p>627-49-1MD-01</p> <p>741665-2-00 203772-0-11 741433-2-00</p> <p>Applicazione rapporti dei pantaloni con inserimento chiusura lampo senza cursore Application of trousers fly facing with insertion of zipper without slider Application de la braguettes des pantalones avec insertion de la fermeture à glissière sans curseur</p>	<p>206350-3-00</p> <p>627-10-1CD-06</p> <p>741665-2-00 202800-0-11 920752-0-11 741453-2-00 206352-0-01</p> <p>Assemblaggi di tessuti medi e leggeri. Con inserimento fettuccia max 8 mm Assembly of medium and light weight fabrics. With reinforcing tape max 8 mm Assemblages de tissus moyens et légers avec bande de renfort max 8 mm</p>	<p>207076-3-01</p> <p>627-00-1CD-30</p> <p>741413-2-00 203041-0-10 741685-2-00 203768-0-11 203772-0-11 203026-0-11 741431-2-00 203112-0-11</p> <p>Assemblaggi di tessuti medi e pesanti Medium and heavy weight fabrics assembly Assemblages des tissus moyens et lourdes</p>
<p>207100-3-01</p> <p>627-00-1CD-25 627-28-1CD-12</p> <p>741665-2-00 202201-0-11 207102-0-01</p> <p>Surfilatura fondo camicie Assemblaggio teli ombrelli Serging the bottom edge de shirts Assembly of umbrella panels Surfilage du bas de chemises Assemblage des parapluies</p>	<p>207147-3-01</p> <p>627-00-1CD-30</p> <p>741675-2-00 203772-0-11 207141-0-01 207146-2-01 741431-2-00 207143-0-01</p> <p>Surfilatura di strofinacci leggeri Serging of light floor-cloths Surfilage de serpilleres legeres</p>	<p>207743-3-01</p> <p>627-49-1MD-03</p> <p>204947-0-10 207822-0-00 207818-0-00 207817-0-00 741685-2-00 207824-0-00 207618-0-00 733503-2-00 207819-0-00</p> <p>Applicazione rapporti dei pantaloni con inserimento chiusura lampo con cursore Application of trousers fly facings with insertion of zipper with slider Applications de les braguettes des pantalons avec insertion de la fermeture à glissière avec curseur</p>	<p>208365-3-00</p> <p>627-00-1CD-21</p> <p>721412-2-00 208368-0-00 208364-0-00 741685-2-00 203768-0-11 203772-0-11 208367-0-00 303805-0-10</p> <p>Assemblaggi tessuti scivolosi Slippery fabrics assembly Assemblages tissus glissants</p>

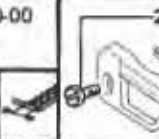
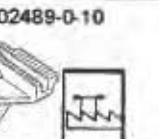
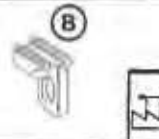
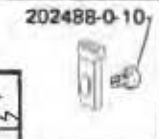
<p>202146-0-10</p>  <p>627-00-1CD-01 627-00-1CD-02 627-00-1CD-07 627-00-1CD-09 627-00-1CD-20 627-00-1CD-31 627-01-1CD-02 627-01-1CD-04 627-01-1CD-05 627-01-1CD-09 627-10-1CD-06 627-22-1CD-02 627-23-1CD-02 627-28-1CD-02 627-28-1CD-07 627-28-1CD-09 627-29-1CD-02 627-29-1CD-05 627-30-1CD-07 627-34-1CD-01</p>	<p>203012-0-10</p>  <p>627-00-1CD-06 627-00-1CD-21 627-00-1CD-30 627-00-1MD-23 627-01-1CD-03 627-01-1MD-08 627-22-1CD-01 627-23-1CD-01 627-34-1MD-03 627-49-1MD-01 627-49-1MD-03</p>	<p>203069-0-10</p>  <p>627-00-1CD-26 627-00-1CD-29</p>	<p>203144-0-10</p>  <p>627-00-1CD-25</p>	<p>207010-2-00</p>  <p>627-28-1CD-12</p> <p>con placchetta in lega dura with hard alloyed plate avec plaquette en alliage dur</p>
<p>207011-0-00</p>  <p>627-28-1CD-12</p>	<p>207015-2-00</p>  <p>627-00-1CD-01 627-00-1CD-02 627-00-1CD-07 627-00-1CD-09 627-00-1CD-31 627-01-1CD-02 627-01-1CD-04 627-01-1CD-05 627-01-1CD-09 627-10-1CD-06 627-22-1CD-02 627-23-1CD-02 627-28-1CD-02 627-28-1CD-07 627-28-1CD-09 627-29-1CD-02 627-29-1CD-05 627-30-1CD-07 627-34-1CD-01 627-38-1CD-01</p> <p>con placchetta in lega dura with hard alloyed plate avec plaquette en alliage dur</p>	<p>207016-2-00</p>  <p>627-00-1CD-06 627-00-1CD-21 627-00-1CD-30 627-00-1MD-23 627-00-1MD-33 627-01-1CD-03 627-01-1MD-08 627-22-1CD-01 627-23-1CD-01 627-34-1MD-03 627-49-1MD-01 627-49-1MD-03</p> <p>con placchetta in lega dura with hard alloyed plate avec plaquette en alliage dur</p>	<p>207017-2-00</p>  <p>627-00-1CD-26 627-00-1CD-29 627-00-1CD-30</p> <p>con placchetta in lega dura with hard alloyed plate avec plaquette en alliage dur</p>	<p>207024-2-00</p>  <p>627-00-1CD-25</p> <p>con placchetta in lega dura with hard alloyed plate avec plaquette en alliage dur</p>

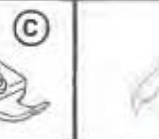
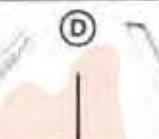
<p>202142-0-10</p>  <p>627-00-1CD-01 627-00-1CD-02 627-00-1CD-07 627-00-1CD-09 627-00-1CD-20 627-00-1CD-29 627-00-1CD-31 627-01-1CD-02 627-01-1CD-04 627-01-1CD-05 627-01-1CD-09 627-10-1CD-06 627-22-1CD-02 627-23-1CD-02 627-28-1CD-02 627-28-1CD-07 627-28-1CD-09 627-30-1CD-07 627-34-1CD-01</p>	<p>202143-0-10</p>  <p>627-00-1CD-01 627-00-1CD-02 627-00-1CD-07 627-00-1CD-09 627-00-1CD-20 627-00-1CD-31 627-01-1CD-02 627-01-1CD-04 627-01-1CD-05 627-01-1CD-09 627-10-1CD-06 627-22-1CD-02 627-23-1CD-02 627-28-1CD-02 627-28-1CD-07 627-28-1CD-09 627-30-1CD-07 627-34-1CD-01</p>	<p>202932-0-10</p>  <p>627-00-1CD-06 627-01-1CD-03 627-22-1CD-01 627-23-1CD-01</p>	<p>203066-0-10</p>  <p>627-00-1CD-25 627-00-1CD-26 627-28-1CD-12 627-29-1CD-02 627-29-1CD-05</p>	<p>203759-0-10</p>  <p>627-00-1MD-23 627-00-1MD-33 627-01-1MD-08 627-34-1MD-03 627-49-1MD-03</p>
<p>203783-0-10</p>  <p>627-00-1MD-23 627-01-1MD-33 627-01-1MD-08 627-34-1MD-03 627-49-1MD-03</p>	<p>207000-2-00</p>  <p>627-00-1CD-01 627-00-1CD-02 627-00-1CD-07 627-00-1CD-09 627-00-1CD-29 627-00-1CD-31 627-01-1CD-02 627-01-1CD-04 627-01-1CD-05 627-01-1CD-09 627-10-1CD-06 627-22-1CD-02 627-23-1CD-02 627-28-1CD-02 627-28-1CD-07 627-28-1CD-09 627-30-1CD-07 627-34-1CD-01 627-38-1CD-01</p> <p>con placchetta in lega dura with hard alloyed plate avec plaquette en alliage dur</p>	<p>207001-2-00</p>  <p>627-00-1CD-06 627-00-1CD-21 627-00-1CD-30 627-01-1CD-03 627-22-1CD-01 627-23-1CD-01</p> <p>con placchetta in lega dura with hard alloyed plate avec plaquette en alliage dur</p>	<p>207003-2-00</p>  <p>627-00-1MD-23 627-00-1MD-33 627-01-1MD-08 627-34-1MD-03 627-49-1MD-01 627-49-1MD-03</p> <p>con placchetta in lega dura with hard alloyed plate avec plaquette en alliage dur</p>	<p>207004-2-00</p>  <p>627-00-1MD-23 627-00-1MD-33 627-01-1MD-08 627-34-1MD-03 627-49-1MD-03</p> <p>con placchetta in lega dura with hard alloyed plate avec plaquette en alliage dur</p>

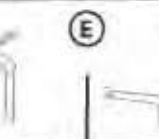

<p>207006.2.00</p>  <p>627.00.1CD.25 627.00.1CD.26 627.00.1CD.30 627.28.1CD.12 627.29.1CD.02 627.29.1CD.05</p> <p>con placchetta in lega dura with hard alloyed plate avec chapelette en alliage dur</p>	<p>207008.2.00</p>  <p>627.00.1CD.01 627.00.1CD.02 627.00.1CD.07 627.00.1CD.09 627.00.1CD.31 627.01.1CD.02 627.01.1CD.04 627.01.1CD.05 627.01.1CD.09 627.10.1CD.06 627.22.1CD.02 627.23.1CD.02 627.28.1CD.02 627.28.1CD.07 627.28.1CD.09 627.30.1CD.07 627.34.1CD.01</p> <p>con placchetta in lega dura with hard alloyed plate avec placquette en alliage dur</p>			
<p>209247.0.00</p>  <p>627.10.1CD.06 627.28.1CD.02 627.34.1MD.03</p>	<p>209213.0.00</p>  <p>627.00.1CD.01 627.00.1CD.06 627.00.1CD.20 627.00.1MD.23 627.01.1CD.02 627.01.1MD.08</p>	<p>209248.0.00</p>  <p>627.00.1CD.02 627.00.1CD.07 627.00.1CD.09 627.00.1CD.21 627.00.1CD.25 627.00.1CD.26 627.00.1CD.29 627.00.1CD.30 627.00.1CD.31 627.00.1MD.33 627.01.1CD.03 627.01.1CD.04 627.01.1CD.05 627.01.1CD.09 627.10.1CD.06 627.22.1CD.01 627.22.1CD.02 627.23.1CD.01 627.23.1CD.02 627.28.1CD.02 627.28.1CD.07 627.28.1CD.09 627.28.1CD.12 627.29.1CD.02 627.29.1CD.05 627.30.1CD.05 627.30.1CD.07 627.34.1CD.01 627.38.1CD.01 627.49.1MD.01 627.49.1MD.03</p>	<p>209264.0.00</p>  <p>627.00.1CD.02 627.00.1CD.07 627.00.1CD.09 627.00.1CD.21 627.00.1CD.25 627.00.1CD.26 627.00.1CD.29 627.00.1CD.30 627.00.1CD.31 627.00.1MD.33 627.01.1CD.03 627.01.1CD.04 627.01.1CD.05 627.01.1CD.09 627.10.1CD.06 627.22.1CD.01 627.22.1CD.02 627.23.1CD.01 627.23.1CD.02 627.28.1CD.02 627.28.1CD.07 627.28.1CD.09 627.28.1CD.12 627.29.1CD.05 627.30.1CD.07 627.34.1CD.01 627.38.1CD.01 627.49.1MD.01</p>	<p>209265.0.00</p>  <p>627.00.1CD.01 627.00.1CD.06 627.00.1CD.20 627.00.1MD.23 627.01.1CD.02 627.01.1MD.08 627.29.1CD.01 627.34.1MD.03 627.49.1MD.03</p>

ORGANI DI CUCITURA				SEWING PARTS				ORGANES DE COUTURE										
R = A RICHIESTA G = GRIFFE GOMMATE ● ▲ ★ = ABBINAMENTI OBBLIGATORI				R = ON REQUEST G = RUBBERED FEED DOGS ● ▲ ★ = FIXED COUPLINGS				R = SUR DEMANDE G = GRIFFES CAOUTCHOUTEES ● ▲ ★ = JUMELAGES OBLIGES										
																		
627-00-2CD-13	203478-0-11 203439-0-11 203441-2-10 203475-0-11 203477-2-10 203482-2-10	R R R R R R	3 4,5 4,6 3,5 3,6 3,1	203421-0-10 207048-0-00	R R	1,5 1	203425-0-10 207049-0-00	R R	1,5 1	203003-0-10		203447-3-12	207000-2-00 202142-0-10 202143-0-10 207008-2-00	R R R R	207015-2-00	209266-0-00	209247-0-00	
627-00-2CD-15	203551-0-11 203579-0-11 203695-0-01	R R R	5 5,2 7	203533-0-10 203668-0-11	R R	1,5 2	203540-0-10 203609-0-10	R R	1,5 2	203612-0-10		204037-3-11	202142-0-10 202143-0-10 207010-2-00 207003-2-00	R R R R	202146-0-10 207015-2-00	R	209266-0-00	209249-0-00
627-00-2CD-16	203552-0-11 203580-0-11 203583-0-11	R R R	5 5,2 6	203536-0-10		1,5	203542-0-10		1,5	203544-0-10		203597-3-11	202142-0-10 202143-0-10 207000-2-00 207008-2-00	R R R R	202146-0-10 207015-2-00	R	209256-0-00	209249-0-00
627-00-2CD-17	204026-0-11 203547-0-11 203578-0-11 204055-0-11	R R R R	7 8 5,5 7,5	206298-0-00 203651-0-11	R R	2 1,5	203609-0-10 203540-0-10	R R	2 1,5	203612-0-10		204037-3-11	203010-0-10 207002-2-00	R	203012-0-10 207016-2-00	R	209267-0-00	209223-0-00
627-00-2CD-18	204006-0-11 204007-0-11 204012-0-11 205650-0-01	R R R R	5,5 6,5 4 7,5	206298-0-00 203651-0-11 203668-0-11	R R R	2 1,5 2	203609-0-10 203540-0-10	R R	2 1,5	203612-0-10		204009-3-12 204017-3-11	203015-0-10 207002-2-00	R R	203012-0-10		209267-0-00	209223-0-00
627-00-2CD-31	208560-0-00		5,5	203199-0-10		1,5	202057-0-10		1,5	202009-0-10		208562-3-00	202142-0-10 202143-0-10 207000-2-00 207008-2-00	R R R R	202146-0-10 207015-2-00	R	209266-0-00	209249-0-00

ORGANI DI CUCITURA				SEWING PARTS				ORGANES DE COUTURE							
R = A RICHIESTA G = GRIFFE GOMMATE ● ▲ ★ = ABBINAMENTI OBBLIGATORI				R=ON REQUEST G=RUBBERED FEED DOGS ●▲★-FIXED COUPLINGS				R=SUR DEMANDE G=GRIFFES CAOUTCHOUTEES ●▲★=JUMELAGES OBLIGES							
627-00-2CD-32	203549-0-11 203548-0-11 203550-0-11	R R	7 7,5 5,5	203532-0-10	2	203539-0-10	2	203544-0-10	203556-3-11	207001-2-00 202932-0-10	R	207016-2-00 203012-0-10	R	209266-0-00	209249-0-00
627-00-2CD-41	203583-0-11 203552-0-11 203580-0-11	R R	6 5 5,2	203536-0-10	1,5	203542-0-10	1,5	203544-0-10	203597-3-11	202142-0-10 202143-0-10 207000-2-00 207008-2-00	R R R	202146-0-10 207015-2-00	R	209266-0-00	209249-0-00
627-00-2CD-44	203436-0-11 203435-0-11 203437-0-11	R R	2,5 3 3,2	203419-2-11 203497-0-10	R G 1	203423-2-11 203498-0-10	R G 1	203426-0-10	203447-3-12	207000-2-00 202142-0-10 202143-0-10 207008-2-00	R R R	207015-2-00 202146-0-10	R	209266-0-00	209247-0-00
627-00-2CD-45	203551-0-11 203695-0-01 203579-0-11	R R	5 7 5,2	203533-0-10 203668-0-11	R 1,5 2	203540-0-10 203609-0-10	R 1,5 2	203612-0-10	204037-3-11	202143-0-10 202142-0-10 207000-2-00 207008-2-00	R R P	202146-0-10 207015-2-00	R	209267-0-00	209223-0-00
627-00-2CD-47	207174-4-00		3	206293-2-00	G	206295-2-00	G	202061-0-10	203447-3-12	207000-2-00		207015-2-00		209266-0-00	209247-0-00
627-00-2MD-02	208332-0-00		5,5	208330-0-00	1,5	207243-0-00	1,5	203003-0-10	208334-3-00	208335-2-00		207015-2-00		209267-0-00	209223-0-00

ORGANI DI CUCITURA			SEWING PARTS			ORGANES DE COUTURE							
R = A RICHIESTA G = GRIFFE GOMMATE ● ▲ ★ = ABBINAMENTI OBBLIGATORI			R = ON REQUEST G = RUBBERED FEED DOGS ● ▲ ★ = FIXED COUPLINGS			R = SUR DEMANDE G = GRIFFES CAOUTCHOUTEES ● ▲ ★ = JUMELAGES OBLIGES							
627-00-2MD-20	204026-0-11 203578-0-11 204055-0-11	R 7 R 5,5 R 7,5	206298-0-00 203651-0-11	R 2 R 1,5	203609-0-10 203540-0-10	R 2 R 1,5	203612-0-10	204037-3-11	207004-2-00 203759-0-10 203783-0-10 207003-2-00	R 207016-2-00 R 203012-0-10	R 209267-0-00	209223-0-00 200245-0-00	R
627-00-2MD-21	204026-0-11 203578-0-11	R 7 R 5,5	206298-0-00 203651-0-11	R 2 R 1,5	203609-0-10 203540-0-10	R 2 R 1,5	203612-0-10	204037-3-11	207004-2-00 203759-0-10 203783-0-10 207003-2-00	R 207016-2-00	R 209267-0-00	209223-0-00	
627-00-2MD-36	204006-0-11 204007-0-11 204012-0-11 205650-0-01	R 5,5 R 6,5 R 4 R 7,5	206298-0-00 203651-0-11 203668-0-11 203607-2-11★	R 2 R 1,5 R 2 R G	203609-0-10 203540-0-10	R 2 R 1,5	203612-0-10	204009-3-12 204017-3-11★	R 203759-0-10 R 203783-0-10 R 207003-2-00 R 207004-2-00	R 203012-0-10 R 207016-2-00	R 209267-0-00	209223-0-00	
627-01-2CD-05	204026-0-11 203547-0-11 203578-0-11 204055-0-11	R 7 R 8 R 5,5 R 7,5	206298-0-00 203651-0-11 203607-2-11★	R 2 R 1,5 R G	203609-0-10 203540-0-10	R 2 R 1,5	203612-0-10	204028-3-11 203618-3-11	R 203010-0-10 R 207002-2-00	R 203012-0-10 R 207016-2-00	R 209267-0-00	209223-0-00	
627-01-2CD-06	204006-0-11 204007-0-11 204012-0-11 205650-0-01	R 5,5 R 6,5 R 4 R 7,5	206298-0-00 203651-0-11 203668-0-11 203607-2-11★	R 2 R 1,5 R 2 R G	203609-0-10 203540-0-10	R 2 R 1,5	203612-0-10	204010-3-11	R 203010-0-10 R 207002-2-00	R 203012-0-10 R 207016-2-00	R 209267-0-00	209223-0-00	
627-01-2CD-20	207571-0-00	5,5	207193-0-00	1,5	207243-0-00	1,5	203612-0-10	207235-3-00	202143-0-10 202142-0-10	R 202146-0-10	209267-0-00	209223-0-00	

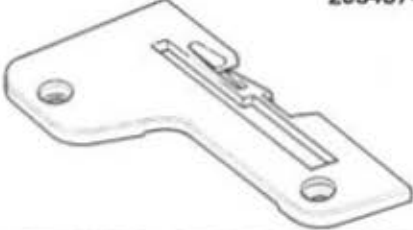
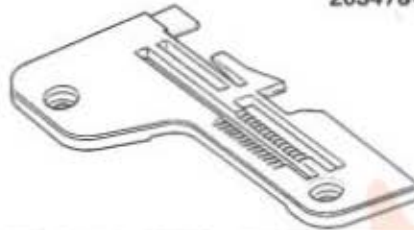
ORGANI DI CUCITURA				SEWING PARTS				ORGANES DE COUTURE										
R = A RICHIESTA G = GRIFFE GOMMATE ● ▲ ★ = ABBINAMENTI OBBLIGATORI				R=ON REQUEST G=RUBBERED FEED DOGS ● ▲ ★ = FIXED COUPLINGS				R=SUR DEMANDE G=GRIFFES CAOUTCHOUTEES ● ▲ ★ = JUMELAGES OBLIGES										
627-01-2MD-07	204026-0-11 204055-0-11 203578-0-11	R R	7 7,5 5,5	206298-0-00 203651-0-10	R R	2 1,5	203609-0-10 203540-0-10	R R	2 1,5	203612-0-10	204028-3-11 204038-3-01 204057-3-11	R R	203759-0-10 203783-0-10 207003-2-00 207004-2-00	R R R	203012-0-10 207016-2-00	R	209267-0-00	209223-0-00
627-01-2MD-11	204006-0-11 204007-0-11 204012-0-11 205650-0-01	R R R R	5,5 6,5 4 7,5	206298-0-00 203651-0-11 203668-0-11 203607-2-11★	R R R R	2 1,5 2 G	203609-0-10 203540-0-10 203611-2-11★	R R R	2 1,5 G	203612-0-10	204010-3-11	203759-0-10 203783-0-10 207003-2-00 207004-2-00	R R R	203012-0-10 207016-2-00	R	209267-0-00	209223-0-00	
627-22-2CD-06	206137-0-00 206117-0-00 206118-0-00 206119-0-00	R R R	7 7 5 5	206138-0-00	R	1,5	206139-0-00	R	1,5	203544-0-10	206135-3-00	202932-0-10 207001-2-00	R	203012-0-10 207016-2-00	R	209266-0-00	209249-0-00	
627-22-2CD-31	209458-0-00		5,5	203140-0-10	R	1,5	203141-0-11	R	1,5	202609-0-10	209082-3-00	202142-0-10 202143-0-10 207000-2-00 207008-2-00	R R R	202146-0-10 207015-2-00	R	209266-0-00	209249-0-00	

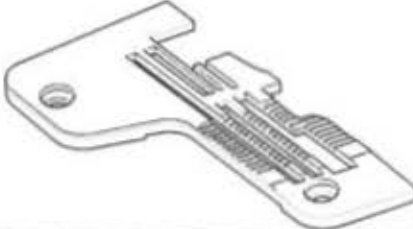
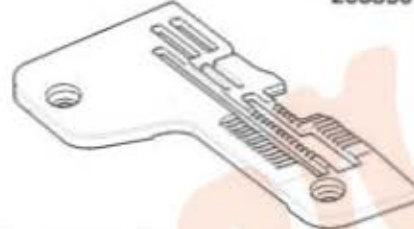
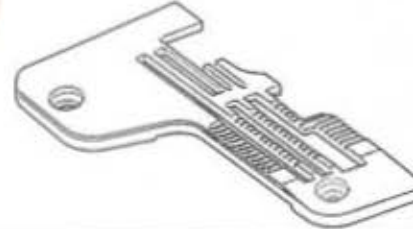
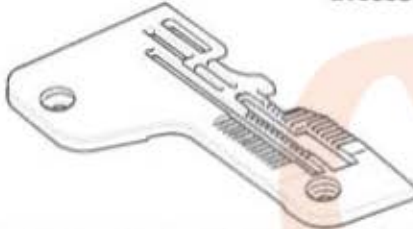
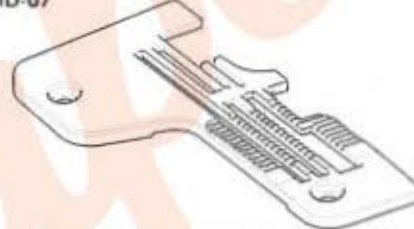
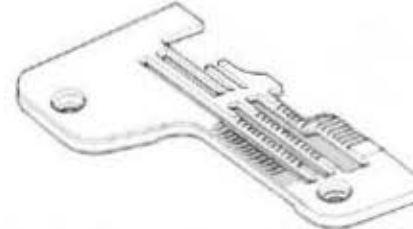
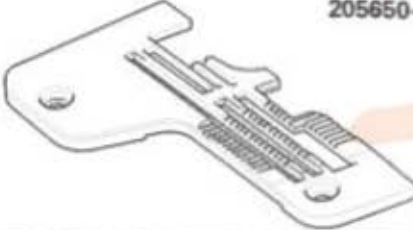
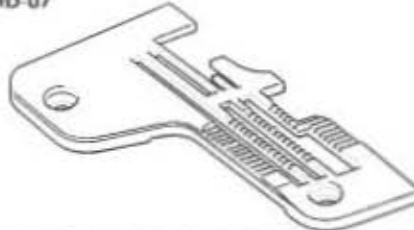
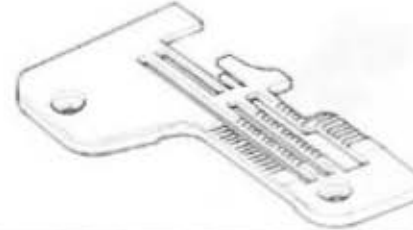
<p>627-00-2CD-44</p>  <p>203435-0-11 3 203436-0-11 2,5 203437-0-11 3,2</p>	<p>627-00-2CD-13</p>  <p>203439-0-11 4,5 203475-0-11 3,5 203478-0-11 3</p>	<p>627-00-2CD-13</p>  <p>203441-2-10 4,6 203477-2-10 3,6 203482-2-10 3,1</p>
<p>627-00-2CD-17 627-01-2CD-05</p>  <p>203547-0-11 8</p>	<p>627-00-2CD-32</p>  <p>203548-0-11 7,5 203549-0-11 7 203550-0-11 5,5</p>	<p>627-00-2CD-15 627-00-2CD-45</p>  <p>203551-0-11 5 203695-0-01 7</p>
<p>627-00-2CD-16 627-00-2CD-41</p>  <p>203552-0-11 5 203580-0-11 5,2 203583-0-11 6</p>	<p>627-00-2CD-17 627-00-2MD-20 627-00-2MD-21 627-01-2CD-05 627-01-2MD-07</p>  <p>203578-0-11 5,5</p>	<p>627-00-2CD-15 627-00-2CD-45</p>  <p>203579-0-11 5,2</p>
<p>627-00-2CD-18 627-00-2MD-36 627-01-2CD-06 627-01-2MD-11</p>  <p>204006-0-11 5,5 204007-0-11 6,5 204012-0-11 4 205650-0-01 7,5</p>	<p>627-00-2CD-17 627-00-2MD-20 627-00-2MD-21 627-01-2CD-05 627-01-2MD-07</p>  <p>204026-0-11 7</p>	<p>627-00-2CD-17 627-00-2MD-20 627-01-2CD-05 627-01-2MD-07</p>  <p>204055-0-11 7,5</p>





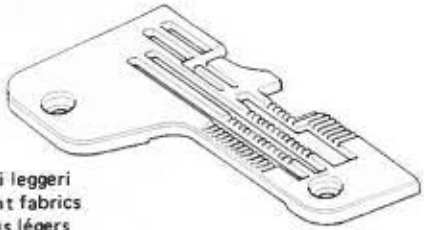
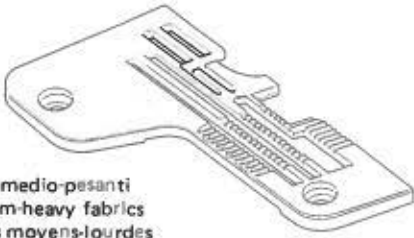
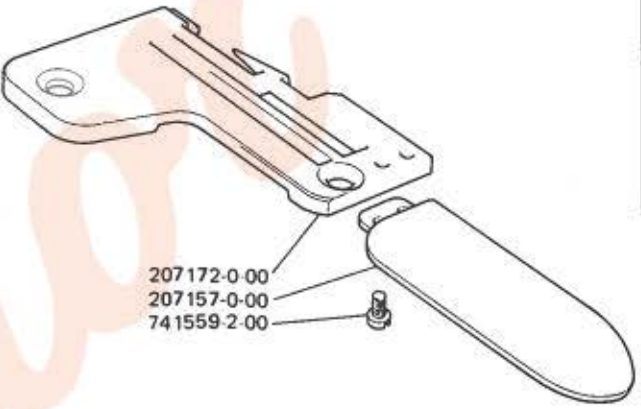
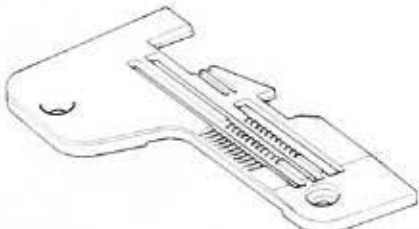
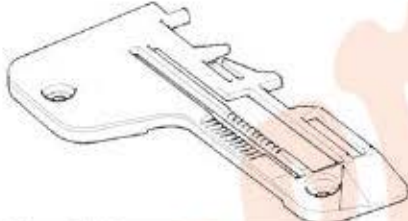
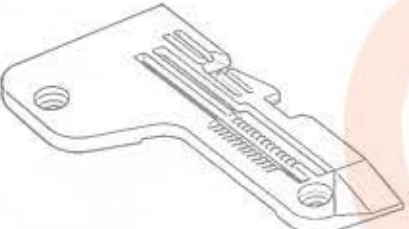
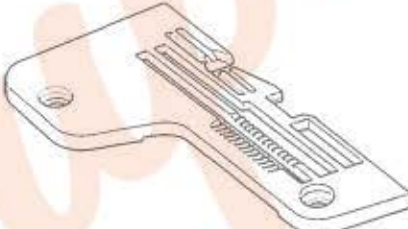

744742-0-00 Vite per placca ago

744742-0-00 Screw for needle plate

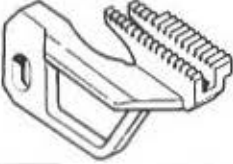
744742-0-00 Vis pour plaque-aiguille

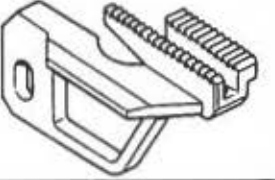
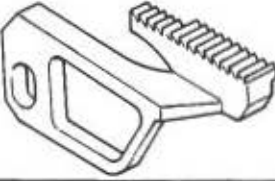
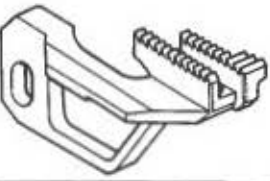
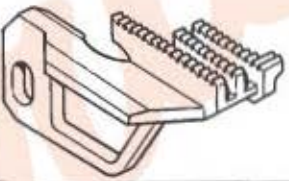
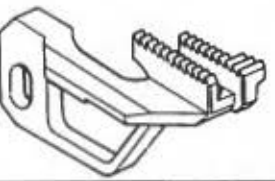
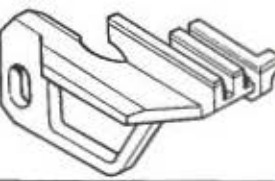
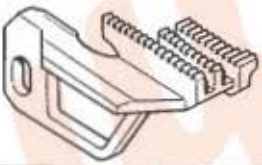
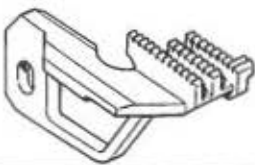
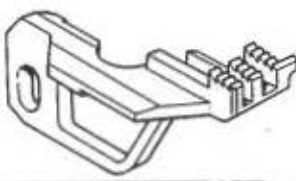
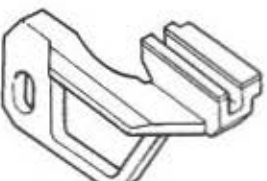
TAV. 44

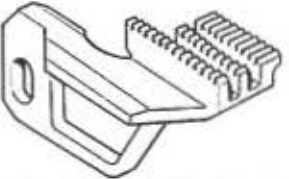
<p>627-22-2CD-06</p> <p>206117-0-00 7 206118-0-00 5</p>  <p>Per tessuti leggeri For weight fabrics Pour tissus légers</p>	<p>627-22-2CD-06</p> <p>206119-0-00 5 206137-0-00 7</p>  <p>Per tessuti medio-pesanti For medium-heavy fabrics Pour tissus moyens-lourdes</p>	<p>627-00-2CD-47</p> <p>207174-4-00 3</p>  <p>207172-0-00 207157-0-00 741559-2-00</p>
<p>627-01-2CD-20</p> <p>207571-0-00 5,5</p> 	<p>627-00-2MD-02</p> <p>208332-0-00 5,5</p> 	
<p>627-00-2CD-31</p> <p>208560-0-00 5,5</p> 	<p>627-22-2CD-31</p> <p>209458-0-00 5,5</p> 	











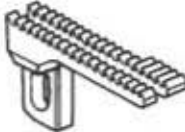





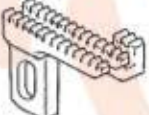

<p>627-22-2CD-31</p> <p>203140-0-10 1,5</p> 	<p>627-00-2CD-31</p> <p>203199-0-10 1,5</p> 	<p>627-00-2CD-44</p> <p>203419-2-11</p> 	<p>627-00-2CD-13</p> <p>203421-0-10 1,5 207048-0-00 1</p> 
<p>627-00-2CD-44</p> <p>203497-0-10 1</p> 	<p>627-00-2CD-32</p> <p>203532-0-10 2</p> 	<p>627-00-2CD-15 627-00-2CD-45</p> <p>203533-0-10 1,5</p> 	<p>627-00-2CD-16 627-00-2CD-41</p> <p>203536-0-10 1,5</p> 
<p>627-00-2CD-17 627-00-2CD-18 627-00-2MD-36 627-01-2CD-05 627-01-2CD-06 627-01-2MD-11</p> <p>203607-2-11</p> 	<p>627-00-2CD-17 627-00-2CD-18 627-00-2MD-20 627-00-2MD-21 627-00-2MD-36 627-01-2CD-06 627-01-2CD-06 627-01-2MD-07 627-01-2MD-11</p> <p>203651-0-11 1,5</p> 	<p>627-00-2CD-15 627-00-2CD-18 627-00-2CD-45 627-00-2MD-36 627-01-2CD-06 627-01-2MD-11</p> <p>203668-0-11 2</p> 	<p>627-22-2CD-06</p> <p>206138-0-00 1,5</p> 
<p>627-00-2CD-47</p> <p>206293-2-00</p> 	<p>627-00-2CD-17 627-00-2CD-18 627-00-2MD-20 627-00-2MD-21 627-00-2MD-36 627-01-2CD-05 627-01-2CD-06 627-01-2MD-07 627-01-2MD-11</p> <p>206298-0-00 2</p> 	<p>627-01-2CD-20</p> <p>207193-0-00 1,5</p> 	<p>627-00-2MD-02</p> <p>208330-0-00 1,5</p> 

202489-0-10 Vite per griffa principale

202489-0-10 Main feed-dog screw





202489-0-10 Vis pour griffe principale









TAV. 46

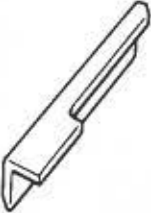

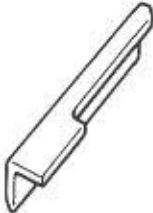
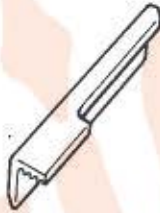



<p>627-00-2CD-31</p> <p>202057-0-10 1,5</p> 	<p>627-22-2CD-31</p> <p>203141-0-11 1,5</p> 	<p>627-00-2CD-44</p> <p>203423-2-11</p> 	<p>627-00-2CD-13</p> <p>203425-0-10 1,5 207049-0-00 1</p> 			
<p>627-00-2CD-44</p> <p>203498-0-10 1</p> 	<p>627-00-2CD-32</p> <p>203539-0-10 2</p> 	<p>627-00-2CD-15 627-00-2CD-17 627-00-2CD-18 627-00-2CD-45 627-00-2MD-20 627-00-2MD-21 627-00-2MD-36 627-01-2CD-05 627-01-2CD-06 627-01-2MD-07 627-01-2MD-11</p> <p>203540-0-10 1,5</p> 	<p>627-00-2CD-15 627-00-2CD-17 627-00-2CD-18 627-00-2CD-45 627-00-2MD-20 627-00-2MD-21 627-00-2MD-36 627-01-2CD-05 627-01-2CD-06 627-01-2MD-07 627-01-2MD-11</p> <p>203609-0-10 2</p> 			
<p>627-00-2CD-17 627-00-2CD-18 627-00-2MD-36 627-01-2CD-05 627-01-2CD-06 627-01-2MD-11</p> <p>203611-2-11</p> 	<p>627-00-2CD-06</p> <p>206139-0-00 1,5</p> 	<p>627-00-2CD-16 627-00-2CD-41</p> <p>203542-0-10 1,5</p> 	<p>627-00-2CD-47</p> <p>206295-2-00</p> 			
<p>627-00-2MD-02 627-01-2CD-20</p> <p>207243-0-00 1,5</p> 	<p>202061-0-10</p> <p>627-00-2CD-47</p> 	<p>202609-0-10</p> <p>627-00-2CD-31 627-22-2CD-31</p> 	<p>203003-0-10</p> <p>627-00-2CD-13 627-00-2MD-02</p> 	<p>203426-0-10</p> <p>627-00-2CD-44</p> 	<p>203544-0-10</p> <p>627-00-2CD-16 627-00-2CD-32 627-00-2CD-41 627-22-2CD-06</p> 	<p>203612-0-10</p> <p>627-00-2CD-15 627-00-2CD-17 627-00-2CD-18 627-00-2CD-45 627-00-2MD-20 627-00-2MD-21</p> <p>627-00-2MD-36 627-01-2CD-05 627-01-2CD-06 627-01-2CD-20 627-01-2MD-07 627-01-2MD-11</p> 

<p>203447-3-12</p> <p>627-00-2CD-13 627-00-2CD-44 627-00-2CD-47</p> <p>741413-2-00 202192-0-10 741675-2-00 203483-0-11 202201-0-11 203453-0-11</p> <p>Cucitura piatta della punta delle calze confezioni di coltanti con cucitura piatta Flat seam for closing stocking toe couture Couture plate pour fermeture de la poite des bas</p>	<p>203556-3-11</p> <p>627-00-2CD-32</p> <p>741685-2-00 203768-0-11 203772-0-11 203569-0-11</p> <p>Assemblaggi di tessuti medi o pesanti, Medium and heavy weight fabrics assembly, Assemblages tissus moyens et épais.</p>	<p>203597-3-11</p> <p>627-00-2CD-16 627-00-2CD-41</p> <p>741675-2-00 203772-0-11 203569-0-11</p> <p>Assemblaggi tessuti leggeri (indemagliabili e camiceria), Light fabrics assembly (warp knit and shirts), Assemblage tissus légers (indemallable et chemise).</p>	<p>203618-3-11</p> <p>627-01-2CD-05</p> <p>741675-2-00 203772-0-11 203569-0-11 741612-2-00 203613-0-11</p> <p>Assemblaggi con fettuccia di rinforzo o elastico max. 4 mm, Assembly with reinforcing tape or elastic mm. 4 max. Assemblages avec bande de renfort ou élastique max. 4 mm.</p>
<p>204009-3-12</p> <p>627-00-2CD-18 627-00-2MD-36</p> <p>741675-2-00 203772-0-11 204011-0-11</p> <p>Assemblaggi di tessuti da medi a pesantissimi, From medium to heavy weight fabrics assembly, Assemblages tissus moyens à épais.</p>	<p>204010-3-11</p> <p>627-01-2CD-06 627-01-2MD-11</p> <p>741675-2-00 203772-0-11 741519-2-00 204011-0-11 204020-0-11</p> <p>Assemblaggio con fettuccia di rinforzo da 6 a 12 mm, Assembly with reinforcing tape from 6 to mm. 12 Assemblages avec bande de renfort da 6 à 12 mm.</p>	<p>204017-3-11</p> <p>627-00-2CD-18 627-00-2CD-36</p> <p>741665-2-00 202201-0-11 204018-0-11</p> <p>Assemblaggi con costa da mm. 4 (da abbinare alla placca 204012-0-11 e alla griffa 203668-0-11) Assembly with mm. 4 bight (couplings to 204012-0-11 plate and 203668-0-11 feed dog.) Assemblages avec surjet 4 mm, (a fournir, avec plaque 204012-0-11 et griffe 203668-0-11).</p>	<p>204028-3-11</p> <p>627-01-2CD-05 627-01-2MD-07</p> <p>741675-2-00 203772-0-11 741519-2-00 203569-0-11 204020-0-11</p> <p>Assemblaggi con fettuccia di rinforzo da 6 a 12 mm, Assembly with reinforcing tape from 6 to mm. 12. Assemblages avec bande de renfort da 6 à 12 mm.</p>

<p>204037-3-11</p> <p>627-00-2CD-15 627-00-2CD-17 627-00-2CD-45 627-00-2MD-20 627-00-2MD-21</p> <p>Assemblaggi di tessuti da leggeri a pesantissimi. To light from heavy fabrics assembly. Assemblages de tissus de légers a tres épais.</p>	<p>204038-3-01</p> <p>627-01-2MD-07</p> <p>Assemblaggi con fettuccia di rinforzo da 6 a 12 mm. e/o con inserimento di elastico 0,8 mm. Assembly with reinforcing tape from 6 to mm, 12 and/or with insertion of elastic mm, 0,8. Assemblages avec bande de renfort da 6 à 12 mm, et/ou avec insertion d'élastique 0,8 mm.</p>	<p>204057-3-01</p> <p>627-01-2MD-07</p> <p>Assemblaggi con fettuccia di rinforzo max. 6 mm. Assembly with reinforcing tape max mm, 6 Assemblages avec bande de renfort max 6 mm.</p>	<p>206135-3-00</p> <p>627-22-2CD-06</p> <p>Assemblaggi con arricciatura di tessuti medi e pesanti. Assembly with gathering of medium and heavy weight fabrics. Assemblages avec froncage de tissus moyens et épais.</p>
<p>207235-3-00</p> <p>627-01-2CD-20</p> <p>Assemblaggi con fettuccia di rinforzo in nylon max. 5 mm. Assembly with nylon reinforcing tape max, mm, 5 Assemblages avec bande de renfort in nylon mm. 5 max.</p>	<p>208334-3-00</p> <p>627-00-2MD-02</p> <p>Assemblaggi di tessuti medi e pesanti. Medium and heavy weight fabrics assembly. Assemblages tissus moyens et épais.</p>	<p>208562-3-00</p> <p>627-00-2CD-31</p> <p>Assemblaggi di tessuti da leggeri a pesanti. To light from heavy fabrics assembly. Assemblages de tissu de légers à épais.</p>	<p>209082-3-00</p> <p>627-22-2CD-31</p> <p>Assemblaggi con arricciatura di tessuti da leggeri a pesanti. Assembly with gathering of light to heavy fabrics. Assemblages avec froncage de tissus légers à épais.</p>

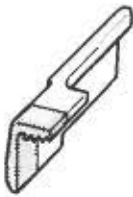
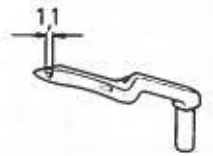
202146-0-10	203012-0-10	207015-2-00	207016-2-00	
 <p>627-00-2CD-15 627-00-2CD-16 627-00-2CD-31 627-00-2CD-41 627-00-2CD-44 627-00-2CD-45 627-01-2CD-20 627-22-2CD-31</p>	 <p>627-00-2CD-17 627-00-2CD-18 627-00-2CD-32 627-00-2MD-20 627-00-2MD-36 627-01-2CD-05 627-01-2CD-06 627-01-2MD-07 627-01-2MD-11 627-22-2CD-06</p>	 <p>627-00-2CD-13 627-00-2CD-15 627-00-2CD-16 627-00-2CD-31 627-00-2CD-41 627-00-2CD-44 627-00-2CD-45 627-00-2CD-47 627-00-2MD-02 627-22-2CD-31</p> <p>con placchetta in lega dura with hard alloyed plate avec plaquette en alliage dur</p>	 <p>627-00-2CD-17 627-00-2CD-32 627-00-2MD-20 627-00-2MD-21 627-00-2MD-36 627-01-2CD-05 627-01-2CD-06 627-01-2MD-07 627-01-2MD-11 627-22-2CD-06</p> <p>con placchetta in lega dura with hard alloyed plate avec plaquette en alliage dur</p>	

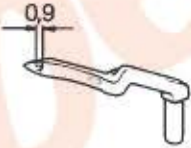
<p>202142-0-10</p>  <p>627-00-2CD-13 627-00-2CD-15 627-00-2CD-16 627-00-2CD-31 627-00-2CD-41 627-00-2CD-44 627-00-2CD-45 627-01-2CD-20 627-22-2CD-31</p>	<p>202143-0-10</p>  <p>627-00-2CD-13 627-00-2CD-15 627-00-2CD-16 627-00-2CD-31 627-00-2CD-41 627-00-2CD-44 627-00-2CD-45 627-01-2CD-20 627-22-2CD-31</p>	<p>202932-0-10</p>  <p>627-00-2CD-32 627-22-2CD-06</p>	<p>203010-0-10</p>  <p>627-00-2CD-17 627-00-2CD-18 627-01-2CD-05 627-01-2CD-06</p>	<p>203759-0-10</p>  <p>627-00-2MD-20 627-00-2MD-21 627-00-2MD-36 627-01-2MD-07 627-01-2MD-11</p>
<p>203783-0-10</p>  <p>627-00-2MD-20 627-00-2MD-21 627-00-2MD-36 627-01-2MD-07 627-01-2MD-11</p>	<p>207000-2-00</p>  <p>627-00-2CD-13 627-00-2CD-15 627-00-2CD-16 627-00-2CD-31 627-00-2CD-41 627-00-2CD-44 627-00-2CD-45 627-00-2CD-47 627-22-2CD-31</p> <p>con placchetta in lega dura with hard alloyed plate avec plaquette en alliage dur</p>	<p>207001-2-00</p>  <p>627-00-2CD-32 627-22-2CD-06</p> <p>con placchetta in lega dura with hard alloyed plate avec plaquette en alliage dur</p>	<p>207002-2-00</p>  <p>627-00-2CD-17 627-00-2CD-18 627-01-2CD-05 627-01-2CD-06</p> <p>con placchetta in lega dura with hard alloyed plate avec plaquette en alliage dur</p>	<p>207003-2-00</p>  <p>627-00-2CD-15 627-00-2MD-20 627-00-2MD-21 627-00-2MD-36 627-01-2MD-07 627-01-2MD-11</p> <p>con placchetta in lega dura with hard alloyed plate avec plaquette en alliage dur</p>

<p>207004-2-00</p>  <p>627-00-2MD-20 627-00-2MD-21 627-00-2MD-36 627-01-2MD-07 627-01-2MD-11</p> <p>con placchetta in lega dura with hard alloyed plate avec plaquette en alliage dur</p>	<p>207008-2-00</p>  <p>627-00-2CD-13 627-00-2CD-16 627-00-2CD-31 627-00-2CD-41 627-00-2CD-44 627-00-2CD-45 627-22-2CD-31</p> <p>con placchetta in lega dura with hard alloyed plate avec plaquette en alliage dur</p>	<p>208335-2-00</p>  <p>627-00-2MD-02</p> <p>con placchetta in lega dura with hard alloyed plate avec plaquette en alliage dur</p>	<p>209223-0-00</p>  <p>627-00-2CD-17 627-00-2CD-18 627-00-2CD-45 627-00-2MD-02 627-00-2MD-20 627-00-2MD-21 627-00-2MD-36 627-01-2CD-05 627-01-2CD-06 627-01-2CD-20 627-01-2MD-07 627-01-2MD-11</p>	
<p>209245-0-00</p>  <p>627-00-2MD-20</p>	<p>209247-0-00</p>  <p>627-00-2CD-13 627-00-2CD-44 627-00-2CD-47</p>	<p>209249-0-00</p>  <p>627-00-2CD-15 627-00-2CD-16 627-00-2CD-31 627-00-2CD-32 627-00-2CD-41 627-22-2CD-06 627-22-2CD-31</p>	<p>209266-0-00</p>  <p>627-00-2CD-13 627-00-2CD-15 627-00-2CD-16 627-00-2CD-31 627-00-2CD-32 627-00-2CD-41 627-00-2CD-44 627-00-2CD-47 627-22-2CD-06 627-22-2CD-31</p>	<p>209267-0-00</p>  <p>627-00-2CD-17 627-00-2CD-18 627-00-2CD-45 627-00-2MD-02 627-00-2MD-20 627-00-2MD-21 627-00-2MD-36 627-01-2CD-05 627-01-2CD-06 627-01-2CD-20 627-01-2MD-07 627-01-2MD-11</p>

GUIDE E PORTA ROTOLI

GUIDES AND ROLL CARRIERS

GUIDES ET PORTE ROULEAUX

R = A RICHIESTA

ON REQUEST

SUR DEMANDE

TESTA HEAD TETE	GUIDA GUIDE GUIDE	SUPPORTO SUPPORT SUPPORT	BLOCCHETTO BLOCK BLOC	PIASTRINA PLATE PLAQUETTE	SQUADRETTA BRACKET EQUERRE	PIEGHETTATORE FOLDING DEVICE PLISSEUR	LEVA LEVER LEVIER	GINOCCHIELLO KNEE-PRESS GENOUILLERE	PORTA ROTOLO ROLL CARRIER PORTE-ROULEAU
627-00-1CD-01	202300-0-10 202767-4-10	R R							
627-00-1CD-02									
627-00-1CD-06									
627-00-1CD-07	202300-0-10 202767-4-10	R R							
627-00-1CD-09									
627-00-1CD-20									
627-00-1CD-21									
627-00-1CD-25									
627-00-1CD-26									
627-00-1CD-29									
627-00-1CD-30									
627-00-1CD-31	202300-0-10 202767-4-10	R R							
627-00-1MD-23									
627-00-1MD-33									
627-01-1CD-02	991225-4-00								991228-4-10
627-01-1CD-03	991225-4-00								991228-4-10

GUIDE E PORTA ROTOLI		GUIDES AND ROLL CARRIERS				GUIDES ET PORTE ROULEAUX			
R = A RICHIESTA		ON REQUEST				SUR DEMANDE			
TESTA HEAD TETE	GUIDA GUIDE GUIDE	SUPPORTO SUPPORT SUPPORT	BLOCCHETTO BLOCK BLOC	PIASTRINA PLATE PLAQUETTE	SQUADRETTA BRACKET EQUERRE	PIEGHETTATORE FOLDING DEVICE PLISSEUR	LEVA LEVER LEVIER	GINOCCHIELLO KNEE-PRESS GENOUILLERE	PORTA ROTOLO ROLL CARRIER PORTE-ROULEAU
627-01-1CD-04	991225-4-00								991228-4-10
627-01-1CD-05	991225-4-00								991228-4-10
627-01-1CD-09	205890-2-00 202300-0-10 202767-4-10	R R	203223-4-10	203239-4-10	202303-0-10	203193-2-10			991589-4-00
627-01-1MD-08	991225-4-00								991228-4-10
627-10-1CD-06	203711-4-11 202851-4-11	R	203708-4-11						
627-22-1CD-01						203193-2-10	204915-4-13	209861-0-00	920176-4-00 920177-4-00
627-22-1CD-02						203193-2-10	204915-4-13	209861-0-00	920176-4-00 920177-4-00
627-23-1CD-01	204930-2-10					203193-2-10	204915-4-13	209861-0-00	920176-4-00 920177-4-00 991589-4-00
627-23-1CD-02	204930-2-10					203193-2-10	204915-4-13	209861-0-00	920176-4-00 920177-4-00 991589-4-00
627-28-1CD-02	202776-0-00 202957-2-10		202958-4-10						
627-28-1CD-07									
627-28-1CD-09									
627-28-1CD-12									
627-29-1CD-02	991225-4-00								991228-4-10
627-29-1CD-05	991225-4-00								991228-4-10
627-30-1CD-07	205975-4-00 209044-0-00		205968-4-00	205966-4-00		203193-2-10			991580-4-00

GUIDE E PORTA ROTOLI

GUIDES AND ROLL CARRIERS

GUIDES ET PORTE ROULEAUX

R = A RICHIESTA

ON REQUEST

SUR DEMANDE

TESTA HEAD TETE	GUIDA GUIDE GUIDE	SUPPORTO SUPPORT SUPPORT	BLOCCHETTO BLOCK BLOC	PIASTRINA PLATE PLAQUETTE	SQUADRETTA BRACKET EQUERRE	PIEGHETTATORE FOLDING DEVICE PLISSEUR	LEVA LEVER LEVIER	GINOCCHIELLO KNEE-PRESS GENOUILLERE	PORTA ROTOLO ROLL CARRIER PORTE-ROULEAU
627-34-1CD-01	991225-4-00								991228-4-10
627-34-1MD-03	205589-0-00 205591-0-00	205593-4-00							
627-38-1CD-01	202311-2-10 205563-2-10	203223-4-10	203239-4-10	205841-0-00 205842-0-00	203193-2-10				990285-4-12 991589-4-00
627-49-1MD-01	204075-2-10	202958-4-10							
627-49-1MD-03	204075-2-10	202958-4-10							
627-00-2CD-13									
627-00-2CD-15									
627-00-2CD-16									
627-00-2CD-17									
627-00-2CD-18									
627-00-2CD-31									
627-00-2CD-32									
627-00-2CD-41									
627-00-2CD-44									
627-00-2CD-45									
627-00-2CD-47									

GUIDE E PORTA ROTOLI		GUIDES AND ROLL CARRIERS				GUIDES ET PORTE ROULEAUX			
R = A RICHIESTA		ON REQUEST				SUR DEMANDE			
TESTA HEAD TETE	GUIDA GUIDE GUIDE	SUPPORTO SUPPORT SUPPORT	BLOCCHETTO BLOCK BLOC	PIASTRINA PLATE PLAQUETTE	SQUADRETTA BRACKET EQUERRE	PIEGHETTATORE FOLDING DEVICE PLISSEUR	LEVA LEVER LEVIER	GINOCCHIELLO KNEE-PRESS GENOUILLERE	PORTA ROTOLO ROLL CARRIER PORTE-ROULEAU
627-00-2MD-02									
627-00-2MD-20									
627-00-2MD-21									
627-00-2MD-36									
627-01-2CD-05	991225-4-00								991228-4-10
627-01-2CD-06	991225-4-00								991228-4-10
627-01-2CD-20	991225-4-00								991228-4-10
627-01-2MD-07	991225-4-00								991228-4-10
627-01-2MD-11	991225-4-00								991228-4-10
627-22-2CD-06					203193-2-10	204915-4-13	209861-0-00	920176-4-00 920177-4-00	
627-22-2CD-31					203193-2-10	204915-4-13	209861-0-00	920176-4-00 920177-4-00	

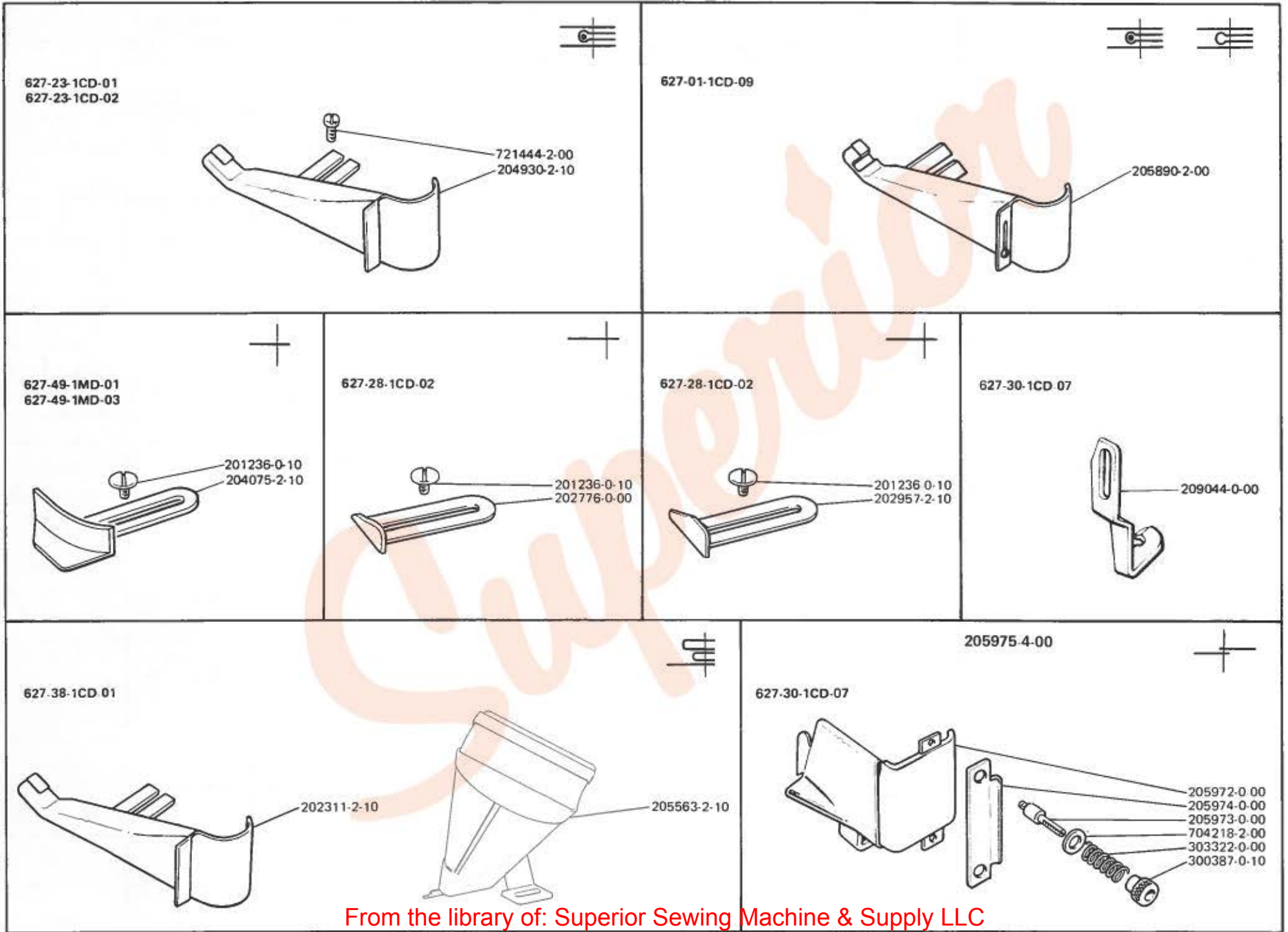

627-01-1CD-09
627-38-1CD-01

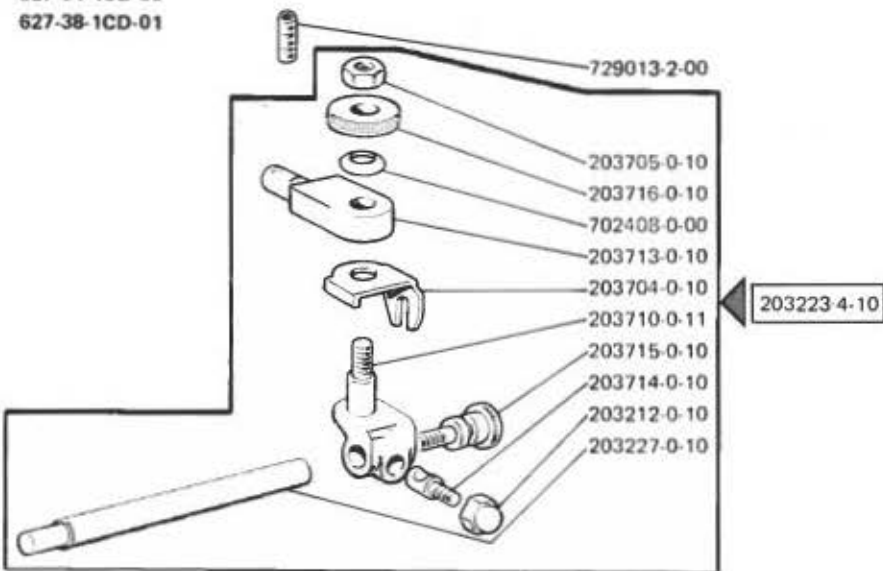

627-30-1CD-07

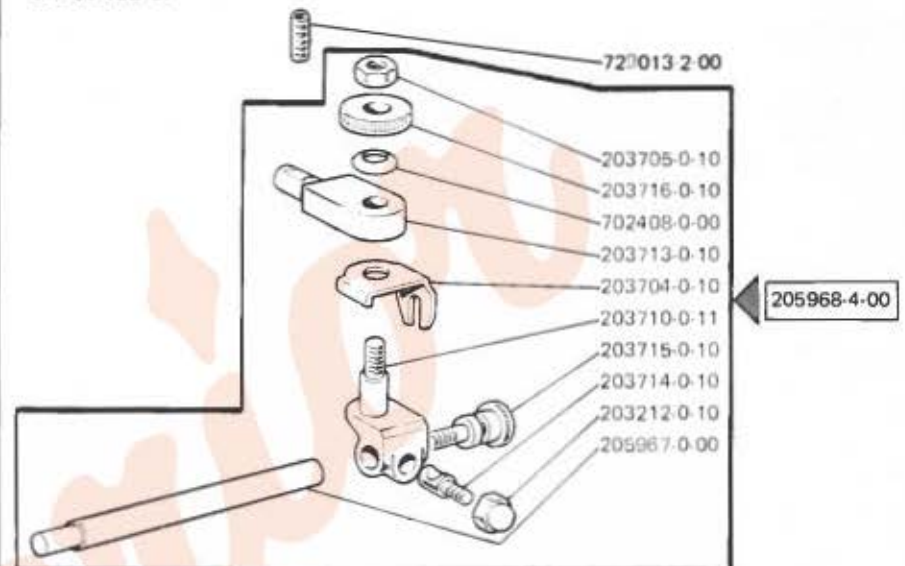

627-10-1CD-06

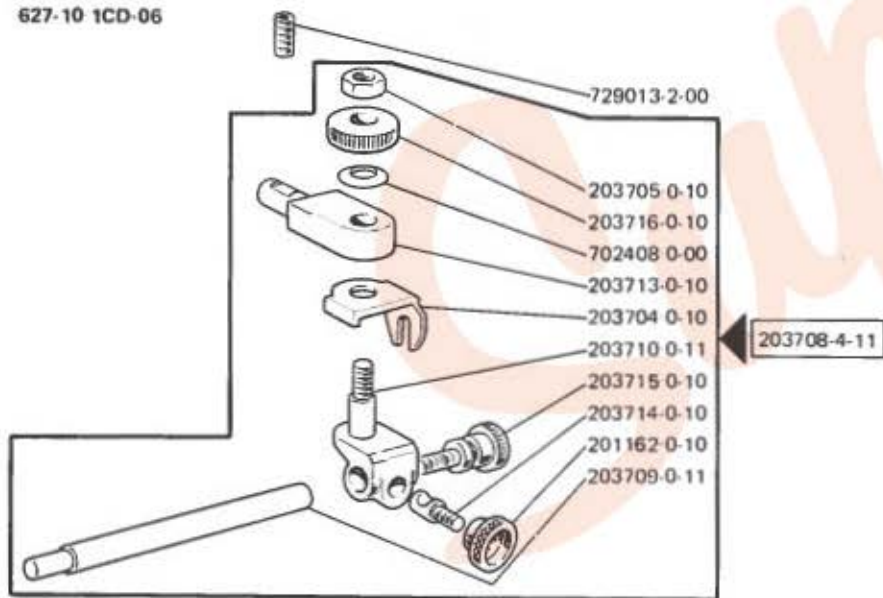

627-28-1CD-02
627-49-1MD-01
627-49-1MD-03

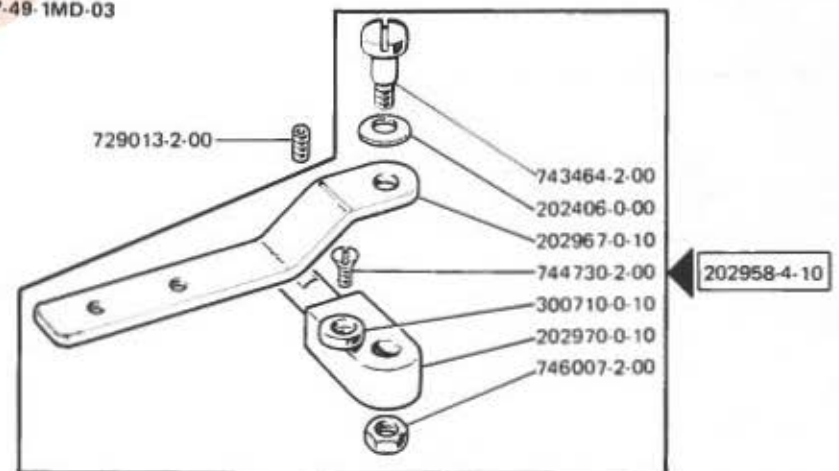

627-10-1CD-06

SOLO A RICHIESTA
ONLY ON REQUEST
SEULEMENT SUR DEMANDE

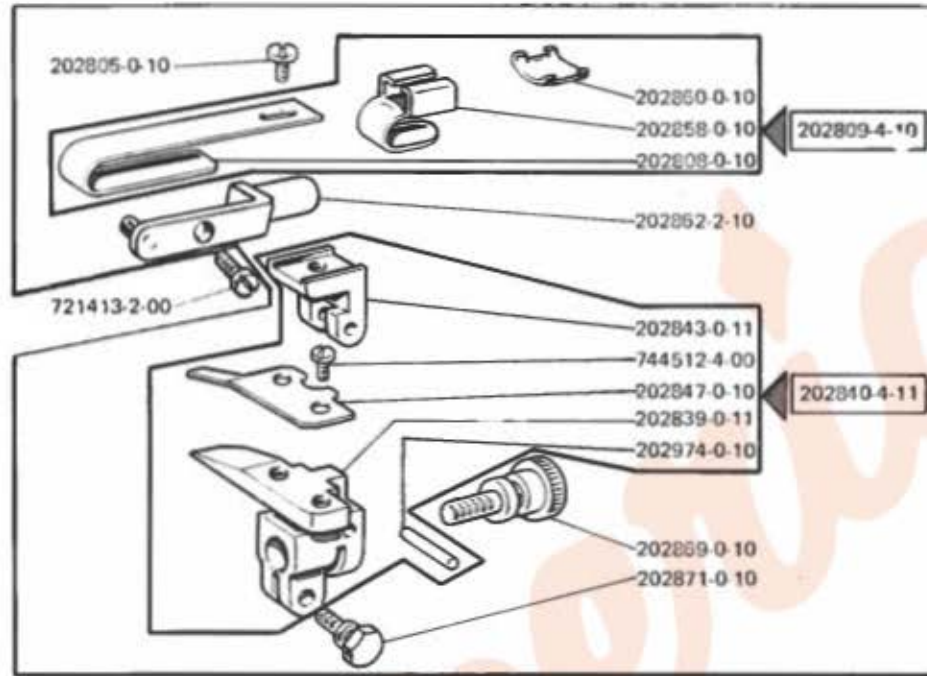

627-10-1CD-06

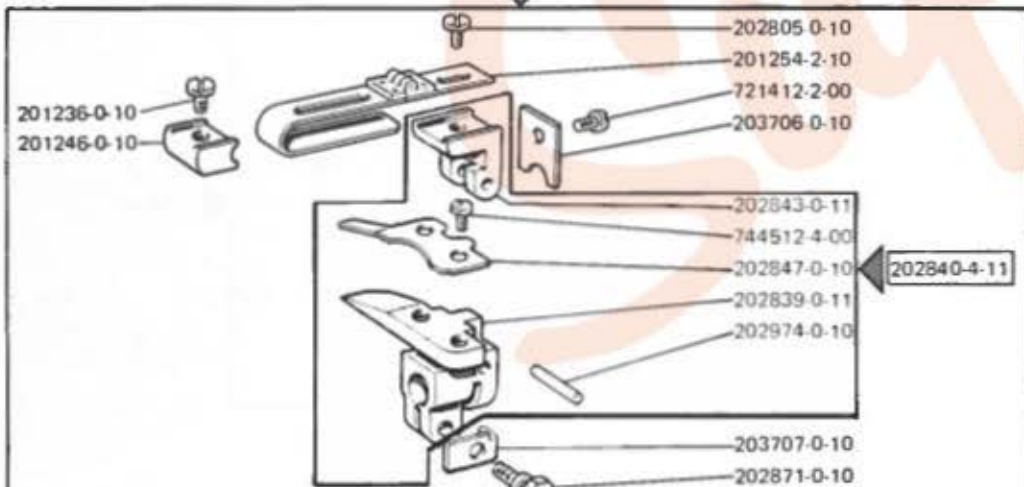

SOLO A RICHIESTA
ONLY ON REQUEST
SEULEMENT SUR DEMANDE

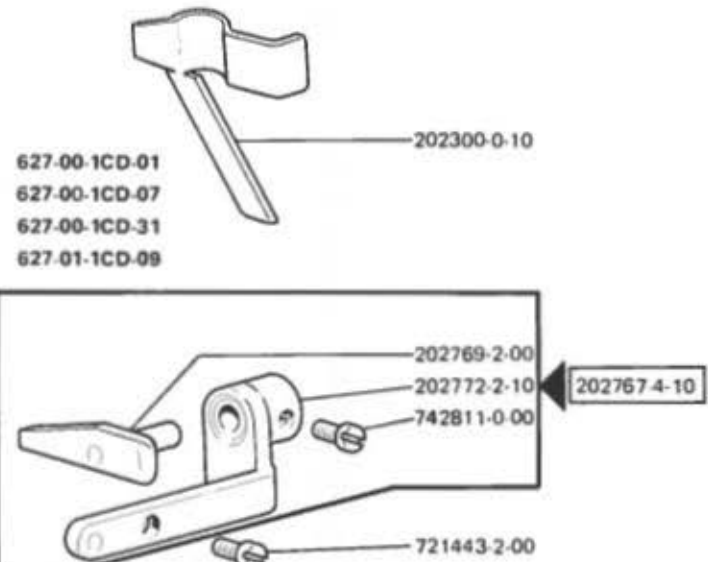

627-34-1MD-03

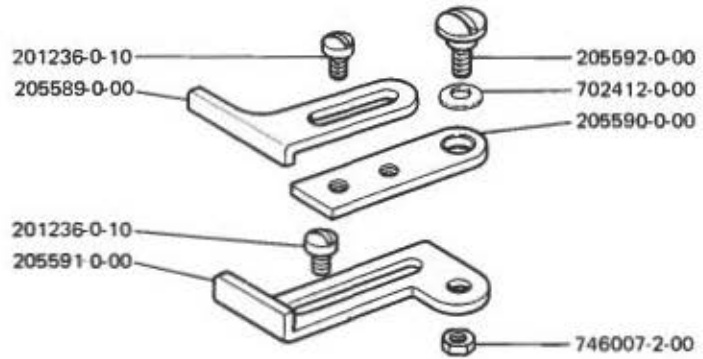

627-34-1MD-03

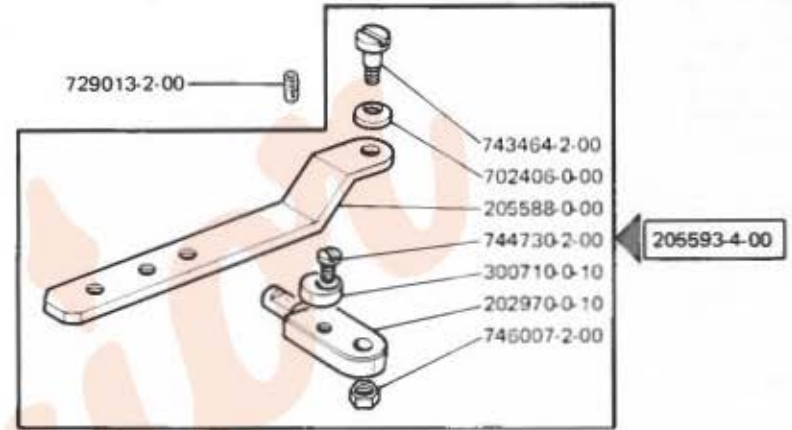

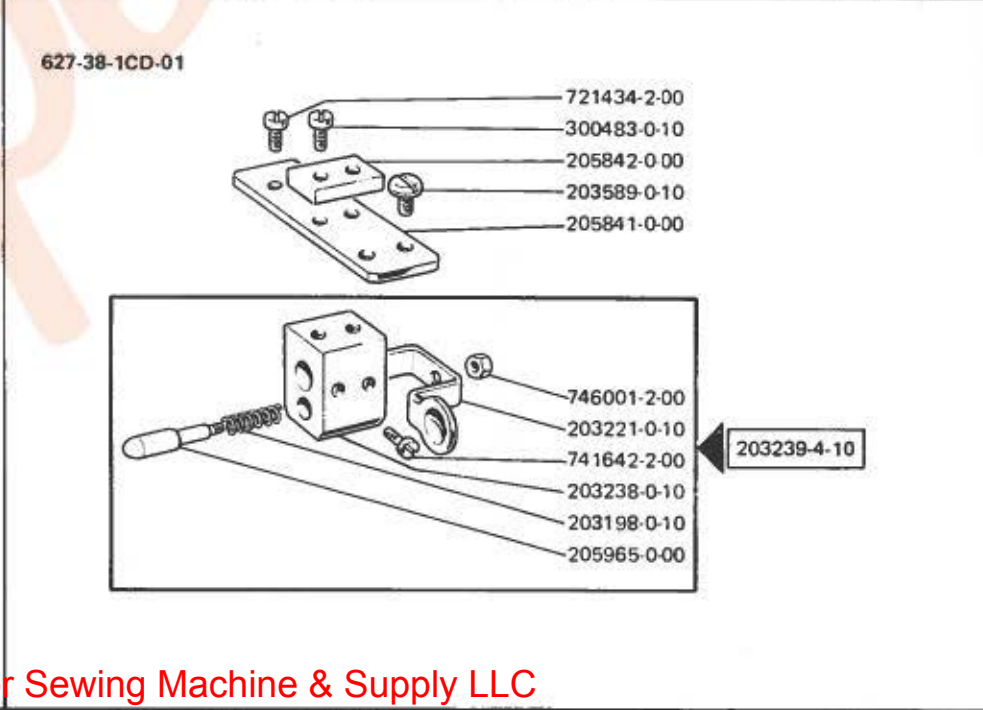
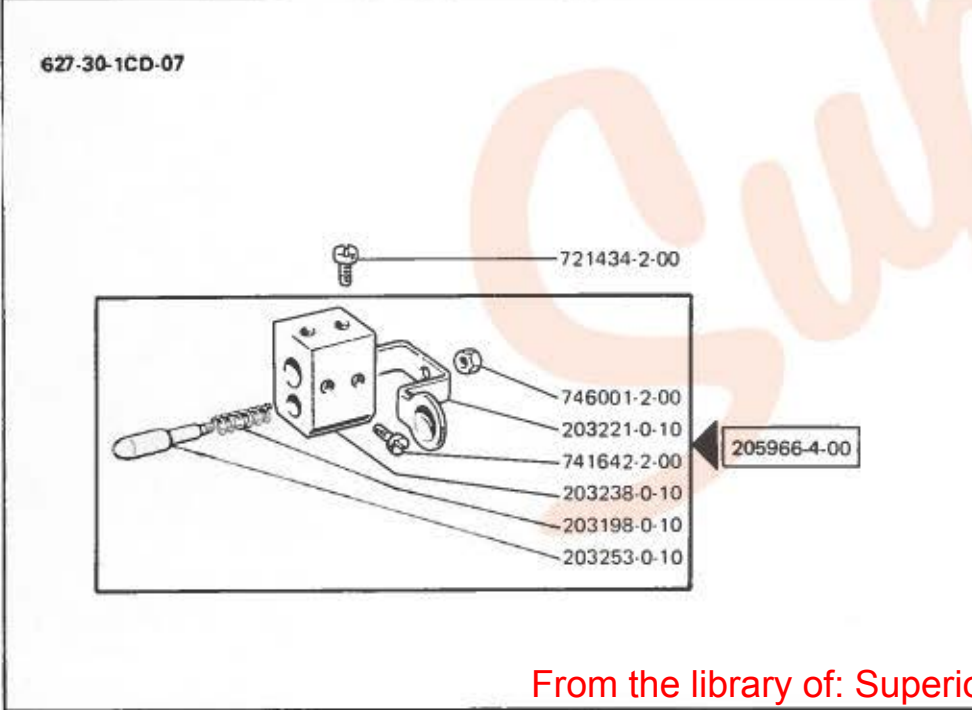
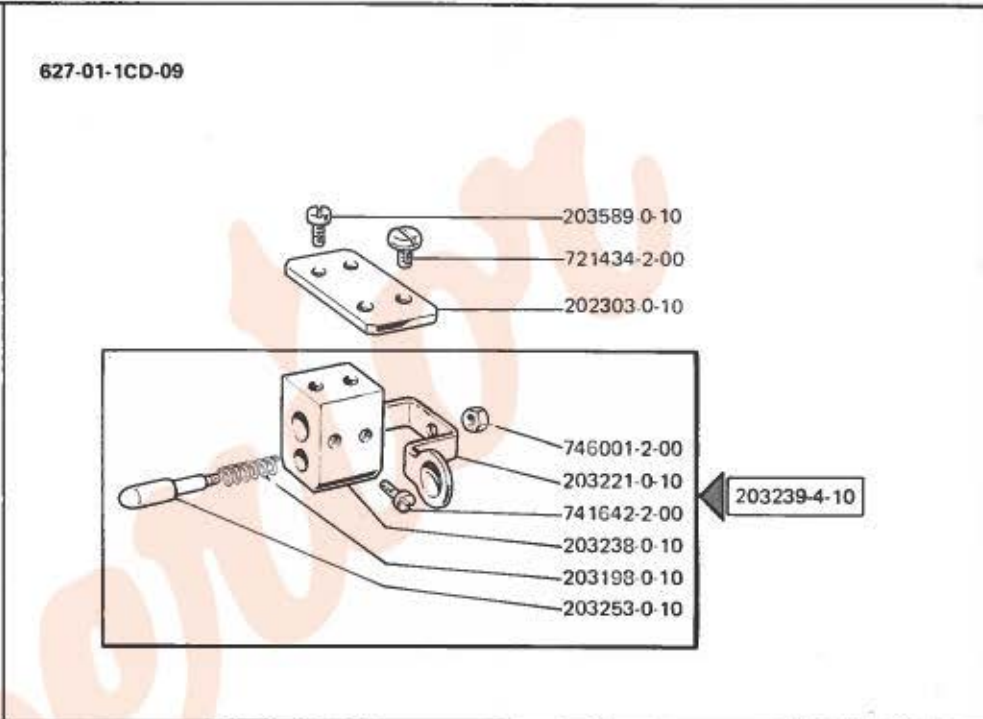
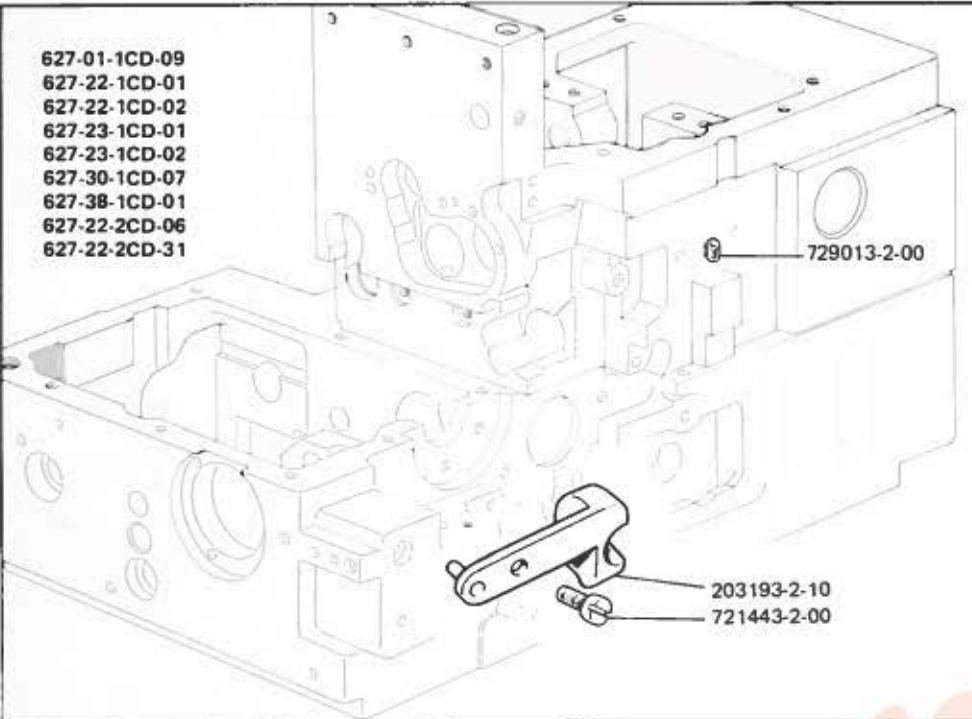

- 627-22-1CD-01
- 627-22-1CD-02
- 627-23-1CD-01
- 627-23-1CD-02
- 627-22-2CD-06
- 627-22-2CD-31

