

# Pfaff 439 Subclass

# PFAFF

## 439

Unterklassen-Ausstattung






Subclass parts

Composition des sous-classes

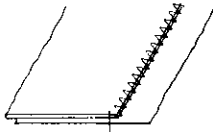
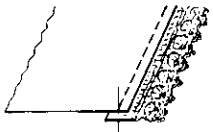
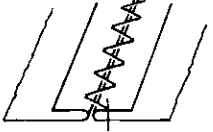

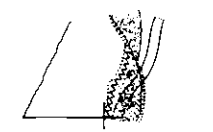
Composición de las subclases

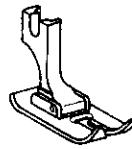
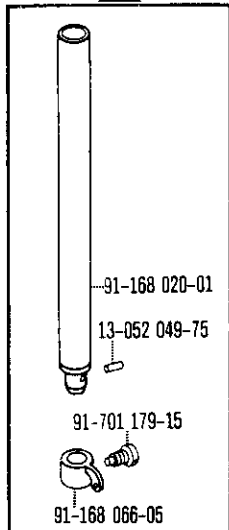

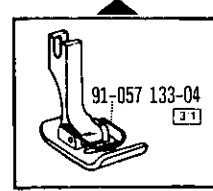


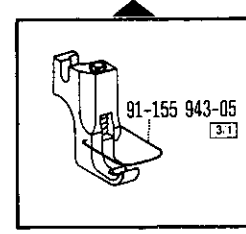
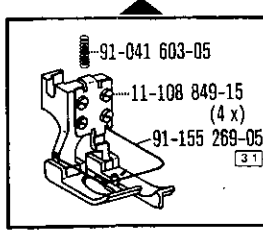
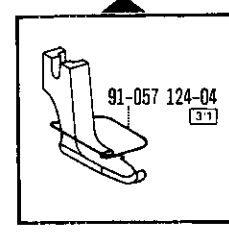
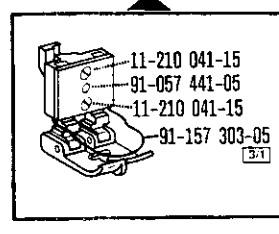


**Table of subclasses**  
**Table des sous-classes**  
**Tabla de subclases**      **PFAFF 439**


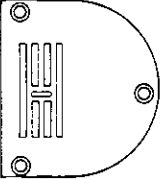


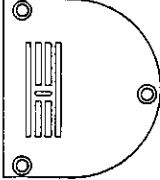

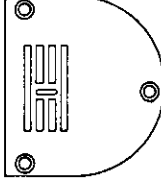

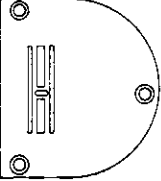

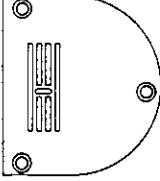

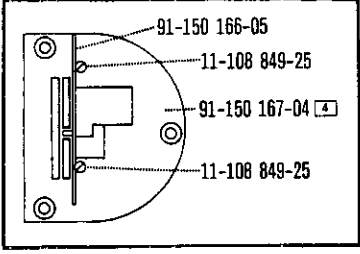

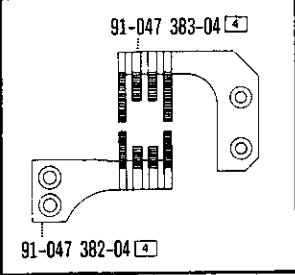

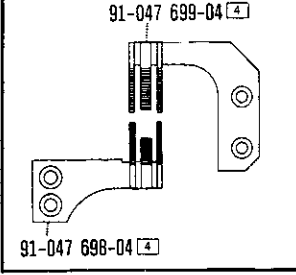

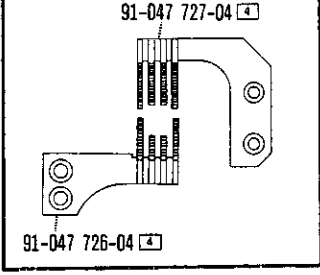

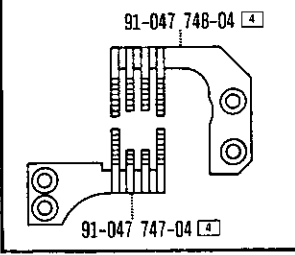

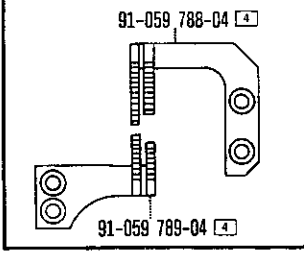
Unterklasse Subclass Sous-classe Subclase	-6/01 (-900/..)	-32/23 (-900/..)	-34/01 (-900/..)	-34/01 (-900/..)
Arbeitsgang Operation Opération Opéracion	Für allgemeine Näharbeiten. Standardform des Teilesatzes. For ordinary sewing operations. Standard parts set. Travaux d'utilité courante. Jeu de pièces standard. Para trabajos de costura en general. Juego de piezas estándar.		Zum Nähen feiner Materialien. Standardform des Teilesatzes. For sewing light fabrics. Standard parts set. Pour la couture de matières fines. Jeu de pièces standard. Para coser materiales finos. Juego de piezas estándar.	Zum Nähen feiner Materialien. Standardform des Teilesatzes. For sewing light fabrics. Standard parts set. Pour la couture de matières fines. Jeu de pièces standard. Para coser materiales finos. Juego de piezas estándar.
Ausführung Model Version Tipo de máquina	AB	BN 24	AN 24; BN 24	AB
Nadelabstand in mm Needle gauge in mm Ecartement des aiguilles en mm Distancia entre agujas en mm	6,0	6,0	3,0	4,5
Nadelstange Needle bar Barre à aiguille Barra de aguja	91-168 019-91	91-168 019-91	91-168 019-91	91-168 019-91
Nähfuß  Presser foot Pied presseur Pie prensateelas	91-054 695-23	91-157 299-93	91-055 170-23	91-055 311-23
Stichplatte  Needle plate Plaque à aiguille Placa de aguja	91-058 034-04	91-058 113-24	91-058 140-24	91-058 211-24
Stoffschieber  Feed dog Griffe Transportador inferior	91-047 381-03	91-047 746-03	91-047 700-03	91-047 729-03
Apparat  Attachment Appareil Aparato		91-047 946-25		
Träger Bracket Support Soporte		91-753 936-25		














**Table of subclasses**  
**Table des sous-classes**  
**Tabla de subclases** PFAFF 439

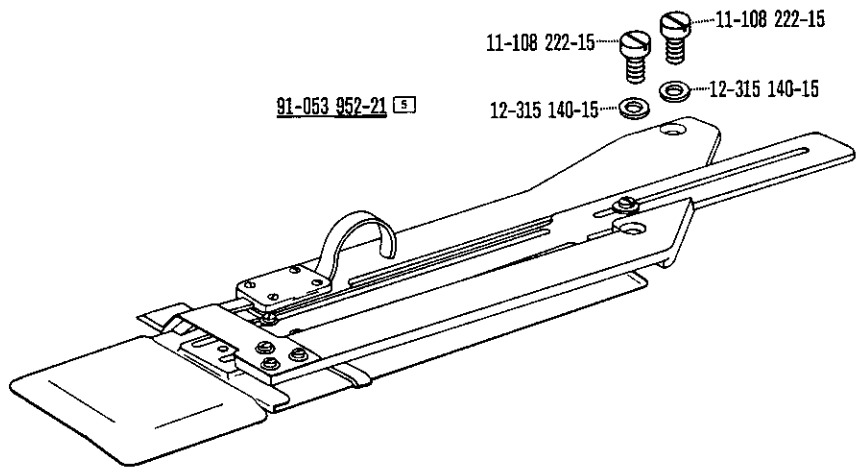
Unterklasse Subclass Sous-classe Subclase	-65/23 (-900/..)	-72/03 (-900/..)	-305/02 (-900/..)	-771/04-6/27 (-900/..)	-771/04-280/06 (-900/..)
Arbeitsgang Operation Opération Operación					
Ausführung Model Version Tipo de máquina	BN 24	AB	AB	AN 13	AN 13
Nadelabstand in mm Needle gauge in mm Ecartement des aiguilles en mm Distancia entre agujas en mm	6,0	6,0	6,0	3,0	3,0
Nadelstange Needle bar Barre à aiguille Barra de aguja	91-168 019-91	91-168 019-91	91-168 019-91	91-168 019-91	91-168 019-91
Nähfuß [4] Presser foot Pied presseur Pie prensateelas	91-155 264-91	91-055 029-23	91-055 110-23	91-155 954-03	91-154 195-91
Stichplatte [4] Needle plate Plaque à aiguille Placa de aguja	91-058 113-24	91-058 035-24	91-058 035-24	91-150 168-93	91-150 168-93
Stoffschieber [4] Feed dog Griffe Transportador interior	91-047 746-03	91-047 613-03	91-047 378-03	91-059 787-03	91-059 787-03
Apparat [5] Attachment Appareil Aparato			91-056 730-23		
Träger Bracket Support Soporte			91-056 731-05		

<p>91-054 695-03 <span style="border: 1px solid black; padding: 0 2px;">4</span></p>  <p style="text-align: right;"><b>-6/01 (-900/..)</b></p>	<p style="text-align: center;"><u>91-168 019-91</u></p>  <p style="text-align: right;"><b>-6/01 (-900/..)</b>  <b>-32/23 (-900/..)</b>  <b>-34/01 (-900/..)</b>  <b>-72/03 (-900/..)</b>  <b>-305/02 (-900/..)</b>  <b>-771/04-6/27 (-900/..)</b>  <b>-771/04-280/06 (-900/..)</b></p>		
<p>91-055 029-04 <span style="border: 1px solid black; padding: 0 2px;">4</span></p>  <p style="text-align: right;"><b>-72/03 (-900/..)</b></p>	<p style="text-align: center;"><u>91-055 110-03</u> <span style="border: 1px solid black; padding: 0 2px;">4</span></p>  <p style="text-align: right;"><b>-305/02 (-900/..)</b></p>	<p>91-055 170-03 <span style="border: 1px solid black; padding: 0 2px;">4</span></p>  <p style="text-align: right;"><b>-34/01 (-900/..)</b></p>	<p>91-055 311-03 <span style="border: 1px solid black; padding: 0 2px;">4</span></p>  <p style="text-align: right;"><b>-34/01 (-900/..)</b></p>
<p style="text-align: center;"><u>91-154 195-91</u> <span style="border: 1px solid black; padding: 0 2px;">4</span></p>  <p style="text-align: right;"><b>-771/04-280/06 (-900/..)</b></p>	<p style="text-align: center;"><u>91-155 264-91</u> <span style="border: 1px solid black; padding: 0 2px;">4</span></p>  <p style="text-align: right;"><b>-65/23 (-900/..)</b></p>	<p style="text-align: center;"><u>91-155 954-04</u> <span style="border: 1px solid black; padding: 0 2px;">4</span></p>  <p style="text-align: right;"><b>-771/04-6/27 (-900/..)</b></p>	<p style="text-align: center;"><u>91-157 299-93</u> <span style="border: 1px solid black; padding: 0 2px;">4</span></p>  <p style="text-align: right;"><b>-32/23 (-900/..)</b></p>

Gauge parts  
 Organes de couture  
 Organos de costura PFAFF 439

<p>91-058 034-04 </p>  <p>-6/01 (-900/..)</p>	<p>91-058 035-04  </p>  <p>-72/03 (-900/..) -305/02 (-900/..)</p>	<p>91-058 113-04 </p>  <p>-32/23 (-900/..) -65/23 (-900/..)</p>
<p>91-058 140-04 </p>  <p>-34/01 (-900/..)</p>	<p>91-058 211-04 </p>  <p>-34/01 (-900/..)</p>	<p>91-150 168-93 </p>  <p>-771/04-6/27 (-900/..) -771/04-280/06 (-900/..)</p>
<p>91-047 381-03 </p>  <p>-6/01 (-900/..)</p>	<p>91-047 700-03 </p>  <p>-34/01 (-900/..)</p>	<p>91-047 729-03 </p>  <p>-34/01 (-900/..)</p>
<p>91-047 746-03 </p>  <p>-32/23 (-900/..) -65/23 (-900/..)</p>	<p>91-059 787-03 </p>  <p>-771/04-6/27 (-900/..) -771/04-280/06 (-900/..)</p>	

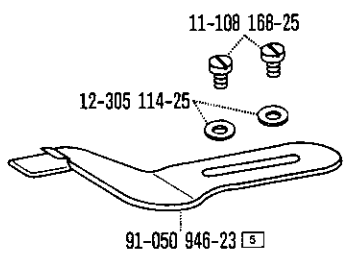
 siehe Erläuterungen Register     
 see explanations in section     
 voir légende registre     
 ver explicaciones del registro   



91-053 952-21 [5]

11-108 222-15  
 11-108 222-15  
 12-315 140-15  
 12-315 140-15

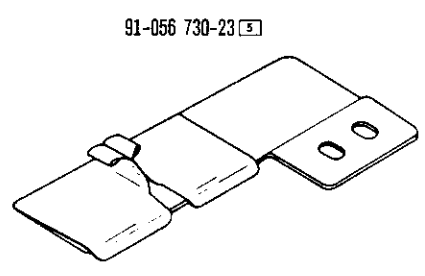
-72/03 (-900/..)



11-108 168-25  
 11-108 168-25  
 12-305 114-25  
 12-305 114-25

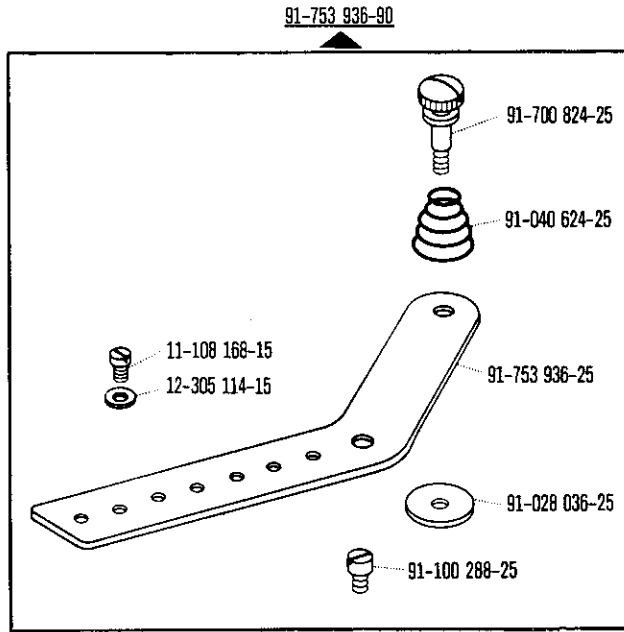
91-050 946-23 [5]

-32/23 (-900/..)

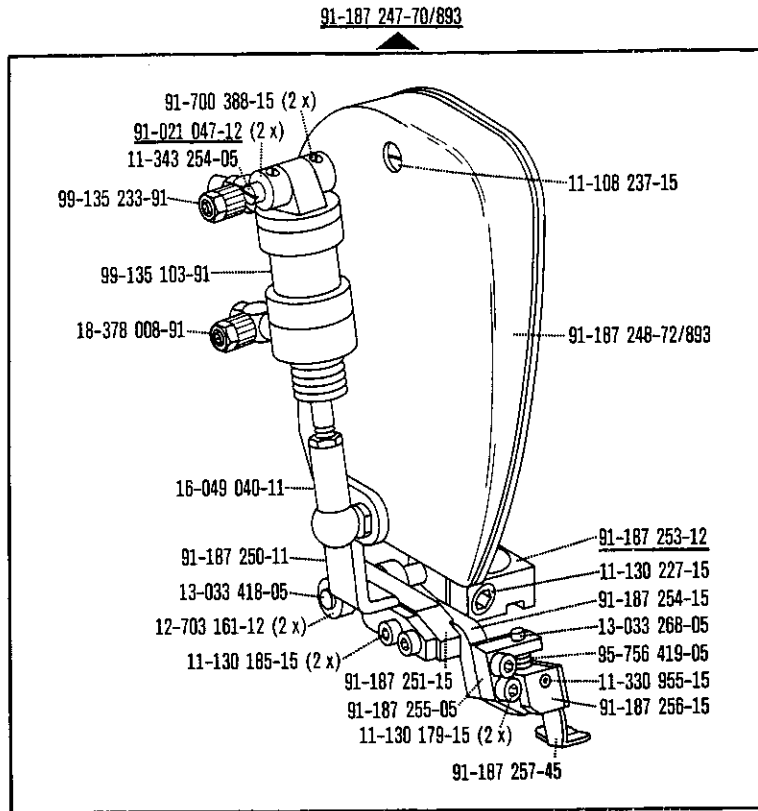


91-056 730-23 [5]

-305/02 (-900/..)



-32/23 (-900/..)  
 -305/02 (-900/..)



-771/04-280/06 (-900/..)