

Pfaff 1427

Subclass

PFAFF

1427

Unterklassen-Ausstattung

Subclass parts

Composition des sous-classes

Composición de las subclases

Unterklassen-Übersicht
 Table of subclasses
 Table des sous-classes
 Tabla de subclases **PFAFF 1427**















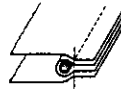

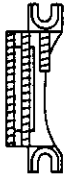



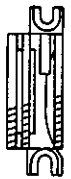

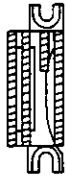



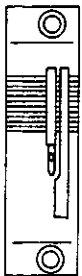

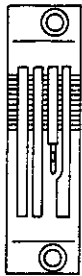

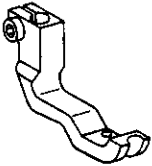

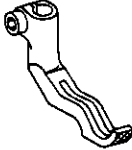

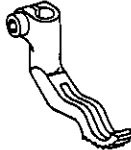
Unterklasse Subclass Sous-classe Subclase	-2/82 (-900/...)	-3/82 (-900/...)	-6/41 (-900/...)
Arbeitsgang Operation Opération Operación	Für rechte Kantennäharbeiten. Standardform des Teilesatzes. Lineal hochklappbar. For reworking right-hand edges. Standard form of the parts kit. Swing-up edge guide. Coutures au bord, à relarge à droite de l'aiguille. Jeu de pièces standard. Guide relevable. Para costuras marginales a la derecha. Juego de piezas estándar. Guía levadiza.	Für linke Kantennäharbeiten. Standardform des Teilesatzes. Lineal hochklappbar. For reworking left-hand edges. Standard form of the parts kit. Swing-up edge guide. Coutures au bord gauge de l'aiguille. Jeu de pièces standard. Guide relevable. Para costuras marginales a la izquierda. Juego de piezas estándar. Guía levadiza.	Für allgemeine Näharbeiten. Standardform des Teilesatzes. For ordinary sewing operations. Standard part set. Travaux d'utilité courante. Jeu de pièces standard. Para trabajos de costura en general. Juego de piezas estándar.
Ausführung Model Version Tipo de máquina	BN 8 CN 8	BN 8 CN 8	BN 8 CN 8
Nadelhalter Needle holder Pince-aiguille Portaagujas	91-166 704-91	91-166 704-91	91-166 704-91
Stoffschieber  Feed dog Griffe Transportador inferior	91-059 919-04	91-059 920-04	91-059 921-04
Stichplatte  Needle plate Plaque à aiguille Placa de aguja	91-150 570-04	91-150 571-04	91-150 572-04
Stoffrückenfuß  Presser foot Pied presseur Pie prensateelas	91-049 968-93	91-049 971-93	91-049 968-93
Stoffschiefenfuß  Vibrating presser Pied entraîneur Transportador superior	91-149 131-93	91-149 134-93	91-149 136-93
Lineal Edge guide Guide-droit Guía recta	09-009 824-22	09-009 844-35	

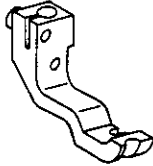
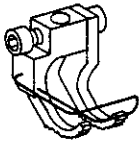
Table of subclasses
Table des sous-classes
Tabla de subclases

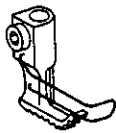
PFAFF 1427

Unterklasse Subclass Sous-classe Subclase	-6/81 (-900/..)	-40/07 (-900/..)	-40/12 (-900/..) [68] = 4 - 10 mm
Arbeitsgang Operation Operation Operación	Für allgemeine Näharbeiten. Standardform des Teilesatzes. For ordinary sewing operations. Standard part set. Travaux d'utilité courante. Jeu de pièces standard. Para trabajos de costura en general. Juego de piezas estándar.		
			
Ausführung Model Version Tipo de máquina	BN 8 CN 8	BN 8 CN 8	BN 8 CN 8
Nadelhalter Needle holder Pince-aiguille Portaaguja	91-166 704-91	91-166 704-91	91-166 704-91
Stoffschieber [4] Feed dog Griffe Transportador inferior	91-059 922-04	91-059 922-04	91-059 922-04
Stichplatte [4] Needle plate Plaque à aiguille Placa de aguja	91-150 572-04	91-150 572-04	91-150 572-04
Stoffdrückerfuß [4] Presser foot Pied presseur Pie prensatelas	91-049 968-93	91-049 956-93	91-049 972-93
Stoffschiebefuß [4] Vibrating presser Pied entraîneur Transportador superior	91-149 139-93	91-149 128-91	91-149 141-91
Apparat [5] Attachment Appareil Aparato		91-156 648-93	91-156 648-93
Träger Bracket Support Soporte		91-156 263-90	91-156 263-90

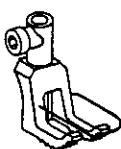
<p>91-166 704-91</p>  <p>11-330 082-15</p> <p>-2/82 (-900/..) -3/82 (-900/..) -6/41 (-900/..) -6/81 (-900/..) -40/07 (-900/..) -40/12 (-900/..)</p>	<p>91-059 919-04 </p>  <p>-2/82 (-900/..)</p>	<p>91-059 920-04 </p>  <p>-3/82 (-900/..)</p>	<p>91-059 921-04 </p>  <p>-6/41 (-900/..)</p>
<p>91-059 922-04 </p>  <p>-6/81 (-900/..) -40/07 (-900/..) -40/12 (-900/..)</p>	<p>91-150 570-04 </p>  <p>-2/82 (-900/..)</p>	<p>91-150 571-04 </p>  <p>-3/82 (-900/..)</p>	<p>91-150 572-04 </p>  <p>-6/41 (-900/..) -6/81 (-900/..) -40/07 (-900/..) -40/12 (-900/..)</p>
<p>91-049 956-93 </p>  <p>-40/07 (-900/..)</p>	<p>91-049 968-93 </p>  <p>-2/82 (-900/..) -6/41 (-900/..) -6/81 (-900/..)</p>	<p>91-049 971-93 </p>  <p>-3/82 (-900/..)</p>	<p>91-049 972-93 </p>  <p>-40/12 (-900/..)</p>
<p>91-149 128-91</p>  <p>-40/07 (-900/..)</p>	<p>91-149 131-93 </p>  <p>-2/82 (-900/..)</p>	<p>91-149 134-93 </p>  <p>-3/82 (-900/..)</p>	<p>91-149 136-93 </p>  <p>-6/41 (-900/..)</p>

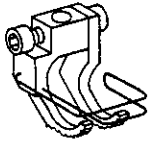
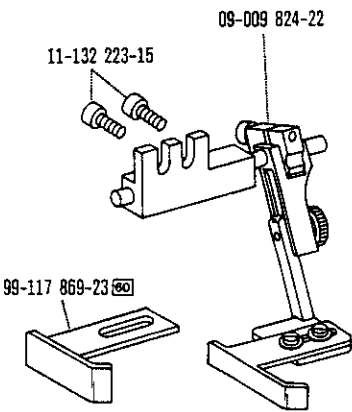
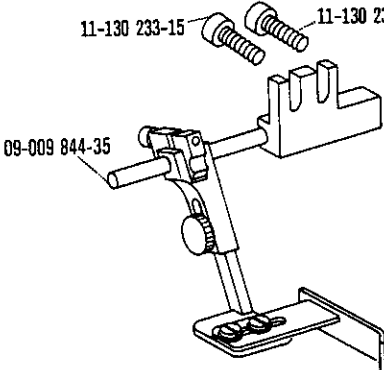
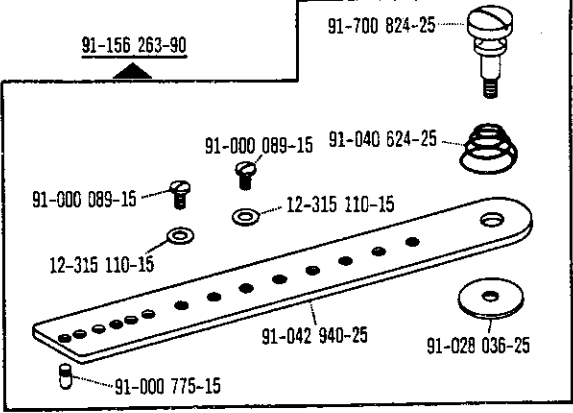
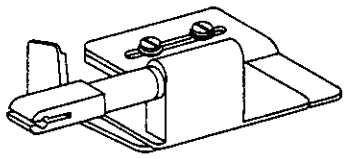
<p>91-149 139-93 A</p>  <p>-6/81 (-900/..)</p>	<p>91-149 141-91</p>  <p>-40/12 (-900/..)</p>	 <p>09-009 824-22</p> <p>11-132 223-15</p> <p>99-117 869-23 B</p> <p>-2/82 (-900/..)</p>
 <p>11-130 233-15</p> <p>11-130 233-15</p> <p>09-009 844-35</p> <p>-3/82 (-900/..)</p>	 <p>91-156 263-90</p> <p>91-700 824-25</p> <p>91-000 089-15</p> <p>91-040 624-25</p> <p>91-000 089-15</p> <p>12-315 110-15</p> <p>12-315 110-15</p> <p>91-042 940-25</p> <p>91-028 036-25</p> <p>91-000 775-15</p> <p>-40/07 (-900/..) -40/12 (-900/..)</p>	
<p>91-156 648-93 C</p>  <p>-40/07 (-900/..) -40/12 (-900/..)</p>		

A siehe Erläuterungen Register. B
 see explanations in section A B