

Pfaff 1422 720 04

Subclass

May 1994

PFAFF

1422-720/04

Unterklassen-Ausstattung

Subclass parts

Composition des sous-classes

Composición de las subclases

Erläuterungen Explanations

Légende Explicaciones

Die Liste enthält nur Nähwerkzeuge sowie unterklassenabhängige Teile. Beim Umbau in eine andere Unterklasse bzw. Ausführung können auch noch Maschinenteile erforderlich sein. Geben Sie also bei Bestellungen die genaue Bezeichnung der vorhandenen bzw. der gewünschten Ausführung an.

The list contains only gauge parts and subclass-dependent parts. For a conversion into another subclass or version machine parts may be required as well. Please state the exact classification of the existing or required version on your order.



La liste comprend uniquement des organes de couture et des pièces dépendant des sous-classes. En cas de transformation en une autre sous-classe ou une autre version, il se peut que d'autres pièces de machine soient nécessaires. C'est pourquoi nous vous prions d'indiquer, à la commande, la désignation exacte de la version existante ou souhaitée.

La lista contiene solamente órganos de costura y piezas dependientes de la subclase. En el caso de transformación en otra subclase o en otro tipo, es posible que sean necesarias piezas de la máquina. Al hacer los pedidos, indíquese la denominación exacta del tipo existente o del deseado.

- 3/1** Gesichert mit Loctite.
Secured with Loctite.
Bloqué par Loctite.
Asegurado con Loctite.
- 4** Ausführungsart bei Bestellung angeben.
Model to be stated on order.
Préciser le modèle à la commande.
Indíquese el tipo en los pedidos.
- 10** Nadelabstand
Needle gauge
Ecartement des aiguilles
Distancia entre agujas
- 10/2** Nadelabstand bei Bestellung angeben.
Needle gauge to be stated on order.
Ecartement des aiguilles; à préciser à la commande.
Indíquese en los pedidos la distancia entre agujas.
- 12** Absteppbreite
Stitching margin
Relarge de couture
Margen de costura
- 12/2** Absteppbreite bei Bestellung angeben.
Stitching margin to be stated on order.
Indiquer le relarge de couture à la commande.
Indíquese el margen de costura en los pedidos.
- 96** Länge angeben.
State length.
Préciser longueur.
Indíquese la largura.

Unterklassen-Übersicht
Table of subclasses

Table des sous-classes
Tabla de subclasses

Unterklasse Subclass Sous-classe Subclase	-6/01-900/..	-113/02-900/..	-748/26-6/01-900/..
Arbeitsgang Operation Opération Operación			Für allgemeine Näharbeiten mittels Standardteilesatz. Die Maschine ist mit Walzen-transport-Einrichtung ausgestattet. For general sewing operations with standard part set. The machine is equipped with puller feed. Pour les coutures d'utilité courante par jeu de pièces standard. La machine est équipée d'un puller. Para trabajos de costura en general mediante juego de piezas estándar. La máquina va equipada con un puller.
Ausführung Model Version Tipo de máquina	BN; B/CN	BN; B/CN	BN; B/CN
Nadelabstand in mm Needle gauge in mm Ecartement des aiguilles en mm Distancia entre agujas en mm	2,4 - 8,0	2,4 - 8,0	4,0 - 8,0
Nadelhalter links $\overline{10/2}$ Needle holder left Pince-aiguille gauche Portaagujas izquierdo	91-166 213-91 $\overline{10}$ = 2,4 mm 91-166 203-93 $\overline{10}$ = 2,8 - 8,0 mm	91-166 213-91 $\overline{10}$ = 2,4 mm 91-166 203-93 $\overline{10}$ = 2,8 - 8,0 mm	91-166 203-93 $\overline{10}$ = 4,0 - 8,0 mm
Nadelhalter rechts $\overline{10/2}$ Needle holder right Pince-aiguille droit Portaagujas derecho	91-166 215-91 $\overline{10}$ = 2,4 mm 91-166 201-93 $\overline{10}$ = 2,8 - 8,0 mm	91-166 215-91 $\overline{10}$ = 2,4 mm 91-166 201-93 $\overline{10}$ = 2,8 - 8,0 mm	91-166 201-93 $\overline{10}$ = 4,0 - 8,0 mm
Stoffschieber $\overline{4}$ $\overline{10/2}$ Feed dog Griffe Transportador inferior	91-059 313-04	91-059 785-04	91-059 313-04
Stichplatte $\overline{4}$ $\overline{10/2}$ Needle plate Plaque à aiguille Placa de aguja	91-150 120-04	91-150 219-04 $\overline{12/2}$ $\overline{12}$ = 1,5 - 3,5 mm	91-150 120-04
Nähfuß $\overline{4}$ $\overline{10/2}$ Presser foot Pied presseur Pie prensatelas	91-054 922-03 $\overline{10}$ = 2,4 - 4,0 mm 91-054 926-03 $\overline{10}$ = 4,8 - 8,0 mm	91-154 003-03 $\overline{12/2}$ $\overline{10}$ = 2,4 - 2,8 mm $\overline{12}$ = 1,5 mm; 2,0 mm 91-154 005-03 $\overline{12/2}$ $\overline{10}$ = 3,2 - 8,0 mm $\overline{12}$ = 1,5 mm 91-154 005-03 $\overline{12/2}$ $\overline{10}$ = 3,2 - 8,0 mm $\overline{12}$ = 2,0 - 3,5 mm	91-460 804-03

Unterklassen-Übersicht Table of subclasses

Table des sous-classes Tabla de subclasses

Unterklasse Subclass Sous-classe Subclase	-748/26-113/02-900/..	-780/04-113/02-900/..-980/05
Arbeitsgang Operation Opération Operación		
Ausführung Model Version Tipo de máquina	BN; B/CN	B
Nadelabstand in mm Needle gauge in mm Ecartement des aiguilles en mm Distancia entre agujas en mm	2,4 - 8,0	2,4 - 8,0
Nadelhalter links $\frac{10}{2}$ Needle holder left Pince-aiguille gauche Portaagujas izquierdo	91-166 213-91 $\frac{10}{2}$ = 2,4 mm 91-166 203-93 $\frac{10}{2}$ = 2,8 - 8,0 mm	91-166 213-91 $\frac{10}{2}$ = 2,4 mm 91-166 203-93 $\frac{10}{2}$ = 2,8 - 8,0 mm
Nadelhalter rechts $\frac{10}{2}$ Needle holder right Pince-aiguille droit Portaagujas derecho	91-166 215-91 $\frac{10}{2}$ = 2,4 mm 91-166 201-93 $\frac{10}{2}$ = 2,8 - 8,0 mm	91-166 215-91 $\frac{10}{2}$ = 2,4 mm 91-166 201-93 $\frac{10}{2}$ = 2,8 - 8,0 mm
Stoffschieber $\frac{4}{10/2}$ Feed dog Griffe Transportador inferior	91-059 785-04	91-059 785-04
Stichplatte $\frac{3}{10/2}$ $\frac{12}{2}$ Needle plate Plaque à aiguille Placa de aguja	91-150 219-04 $\frac{12}{2}$ = 1,5 - 3,5 mm	91-150 202-93 $\frac{12}{2}$ = 1,5 - 3,5 mm
Nähfuß $\frac{4}{10/2}$ $\frac{12}{2}$ Presser foot Pied presseur Pie prensatelas	91-154 387-03 $\frac{10}{2}$ = 2,4 - 2,8 mm $\frac{12}{2}$ = 1,5 mm; 2,0 mm $\frac{10}{2}$ = 3,2 - 8,0 mm $\frac{12}{2}$ = 1,5 mm 91-154 389-03 $\frac{10}{2}$ = 3,2 - 8,0 mm $\frac{12}{2}$ = 2,0 - 3,5 mm	91-155 902-03 $\frac{10}{2}$ = 2,4 - 2,8 mm $\frac{12}{2}$ = 1,5 mm; 2,0 mm $\frac{10}{2}$ = 3,2 - 8,0 mm $\frac{12}{2}$ = 1,5 mm 91-155 911-03 $\frac{10}{2}$ = 3,2 - 8,0 mm $\frac{12}{2}$ = 2,0 - 3,5 mm
Niederhalter Work retainer Pied de maintien Pie de retención		91-154 061-91

**Nähwerkzeuge
Gauge parts**

**Organes de couture
Organos de costura**

91-166 201-93 $\frac{10}{2}$
 $\frac{10}{10}$ = 2,8 - 8,0 mm

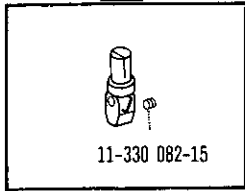

11-330 082-15

-6/01-900/..
-113/02-900/..
-748/26-6/01-900/..
-748/26-113/02-900/..
-780/04-113/02-900/..-980/05

91-166 203-93 $\frac{10}{2}$
 $\frac{10}{10}$ = 2,8 - 8,0 mm

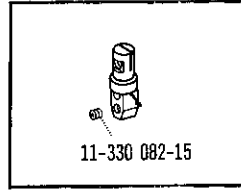

11-330 082-15

-6/01-900/..
-113/02-900/..
-748/26-6/01-900/..
-748/26-113/02-900/..
-780/04-113/02-900/..-980/05

91-166 213-91
 $\frac{10}{10}$ = 2,4 mm

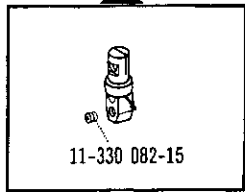

11-330 082-15

-6/01-900/..
-113/02-900/..
-748/26-113/02-900/..
-780/04-113/02-900/..-980/05

91-166 215-91
 $\frac{10}{10}$ = 2,4 mm

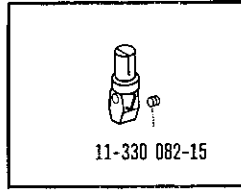

11-330 082-15

-6/01-900/..
-113/02-900/..
-748/26-113/02-900/..
-780/04-113/02-900/..-980/05

91-059 313-04 $\frac{4}{4}$ $\frac{10}{2}$
 $\frac{10}{10}$ = 2,4 - 4,0 mm



-6/01-900/..
-748/26-6/01-900/..

91-059 313-04 $\frac{4}{4}$ $\frac{10}{2}$
 $\frac{10}{10}$ = 4,8 - 8,0 mm



-6/01-900/..
-748/26-6/01-900/..

91-059 785-04 $\frac{4}{4}$ $\frac{10}{2}$
 $\frac{10}{10}$ = 2,4 - 4,0 mm



-113/02-900/..
-748/26-113/02-900/..
-780/04-113/02-900/..-980/05

91-059 785-04 $\frac{4}{4}$ $\frac{10}{2}$
 $\frac{10}{10}$ = 4,8 - 8,0 mm



-113/02-900/..
-748/26-113/02-900/..
-780/04-113/02-900/..-980/05

Nähwerkzeuge
Gauge parts

Organes de couture
Organos de costura

91-150 120-04 [4] [10/2] [12/2]
[10] = 2,4 - 4,0 mm



-6/01-900/..
-748/26-6/01-900/..

91-150 120-04 [4] [10/2] [12/2]
[10] = 4,8 - 8,0 mm

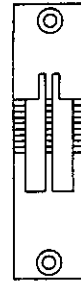

-6/01-900/..
-748/26-6/01-900/..

91-150 202-93 [4] [10/2] [12/2]
[10] = 2,4 - 4,0 mm [12] = 1,5 - 3,5 mm

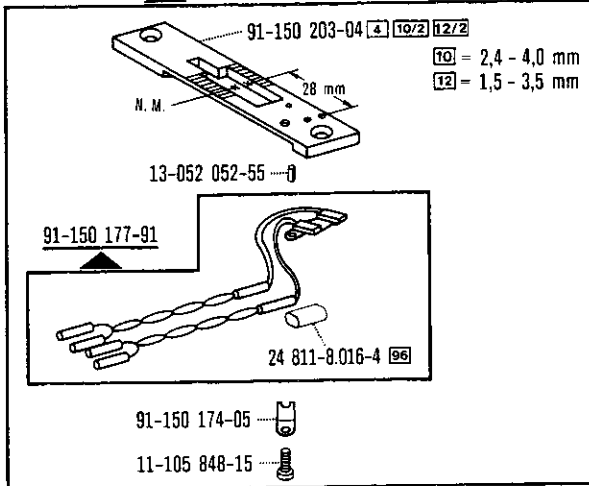

-780-04-113/02-900/..-980/05

91-150 202-93 [4] [10/2] [12/2]
[10] = 4,8 - 8,0 mm [12] = 1,5 - 3,5 mm

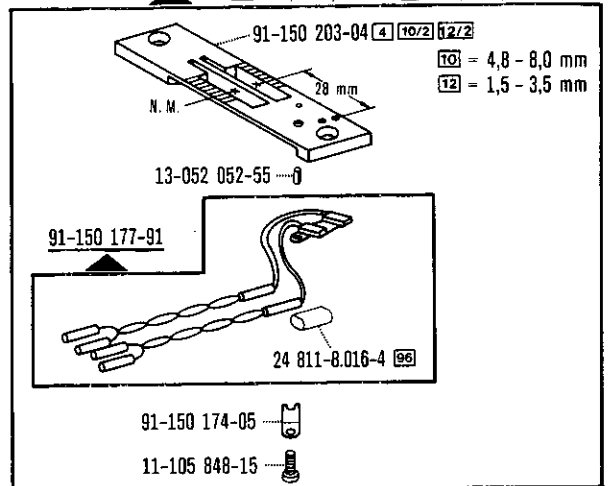

-780-04-113/02-900/..-980/05

91-150 219-04 [4] [10/2] [12/2]
[10] = 2,4 - 4,0 mm
[12] = 1,5 - 3,5 mm



-113/02-900/..
-748/26-113/02-900/..



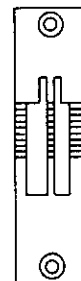









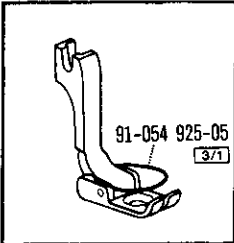



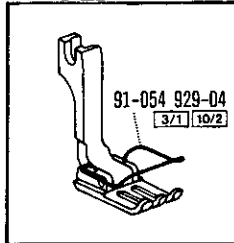





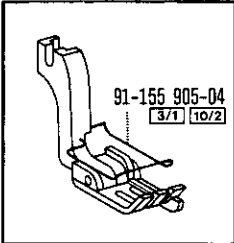





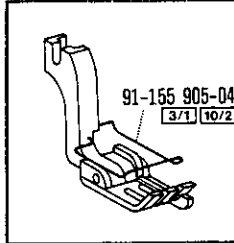





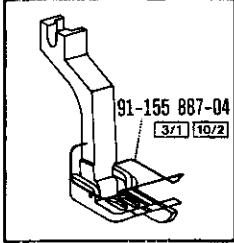





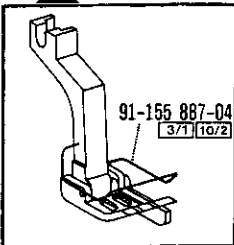





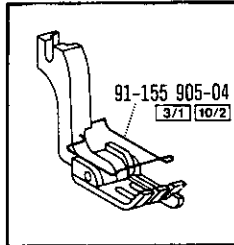

91-150 219-04 [4] [10/2] [12/2]
[10] = 4,8 - 8,0 mm
[12] = 1,5 - 3,5 mm

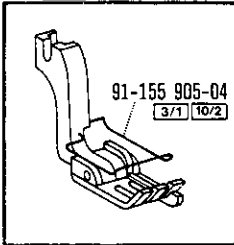

-113/02-900/..
-748/26-113/02-900/..

Nähwerkzeuge
Gauge parts

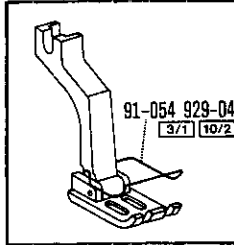
Organes de couture
Organos de costura

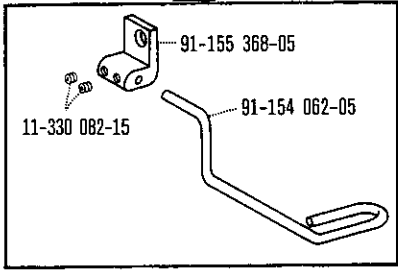
<p>91-054 922-03  </p>  <p>91-054 925-05  </p> <p>-6/01-900/..</p>	<p>91-054 926-03  </p>  <p>91-054 929-04  </p> <p>-6/01-900/..</p>	<p>91-154 003-03   </p>  <p>91-155 905-04  </p> <p>-113/02-900/..</p>	<p>91-154 005-03   </p>  <p>91-155 905-04  </p> <p>-113/02-900/..</p>	<p>91-154 387-03   </p>  <p>91-155 887-04  </p> <p>-748/26-113/02-900/..</p>
<p>91-154 389-03   </p>  <p>91-155 887-04  </p> <p>-748/26-113/02-900/..</p>	<p>91-155 902-03   </p>  <p>91-155 905-04  </p> <p>-780/04-113/02-900/..-980/05</p>	<p>91-155 911-03   </p>  <p>91-155 905-04  </p> <p>-780/04-113/02-900/..-980/05</p>	<p>91-460 804-03  </p>  <p>91-054 929-04  </p> <p>-748/26-6/01-900/..</p>	
<p>91-154 061-91</p>  <p>91-155 368-05 11-330 082-15 91-154 062-05</p> <p>-780/04-113/02-900/..-980/05</p>				