

**FIRST
EDITION**



Union Special
INDUSTRIAL SEWING EQUIPMENT

CATALOG NO. 46

STYLES

7800 A

7800 B

7800 C

7800 D

PRICE LIST AND ILLUSTRATION OF PARTS

FOR

FLAT BED MACHINES

PRICE LIST

and

ILLUSTRATIONS OF PARTS

for

FLAT BED MACHINES

CLASS 7800

FOR REPAIRS ONLY

CATALOG No. 46

Union Special Machine Company

General Office: 400 North Franklin Street

Factory: Franklin Street, Kinzie Street and Austin Avenue

CHICAGO, ILLINOIS

BRANCHES

United States

New York City, N. Y.; 65 Bleecker St.
Philadelphia, Pa.; 12th & Arch St.
Boston, Mass.; 144 Kingston St.
Cincinnati, Ohio; 229 East Sixth St.
St. Louis, Mo.; 1127 Pine St.
San Francisco, Cal.; 682 Mission St.
Rochester, N. Y.; 114 St. Paul St.
Minneapolis, Minn.; Room 4, Old Colony Building.
Utica, N. Y.; 2-9 Elandina St.
Amsterdam, N. Y.; 13 Railroad St.
Cohoes, N. Y.; 51 Mohawk St.
Johnson City, N. Y.; 16 N. Broad St.

Foreign

Paris, France; 87 Boulevard de Sebastopol.
Leicester, England; Fox Lane, Humberstone Gate.
Dundee, Scotland; 17 Baltic Street.
Toronto, Ontario, Canada; 64 Temperance Street.
Montreal, Quebec, Canada; 261 Craig St., West.
Melbourne, Australia; 253-7 Wellington Street.
Buenos Aires, Arg. Rep., S. A.; 135 Calle Maipu.
Osaka, Japan; 36-37, Imabashi-dori Sanchoe, Higashiku.
Havana, Cuba; Apartado 45.
Honolulu, T. H.; 832 Fort Street.
Mexico City, Mexico; Apartado 10063.
Auckland, New Zealand; 33 Wellesley St., West.
Johannesburg, South Africa; 19 Harrison Street.

Copyright 1920
by
Union Special Machine Co.
Chicago, Illinois

Important Notice to Customers

THE PARTS LISTED in this catalog are furnished at list prices, subject to change without notice, for repairs only.

Attention is hereby called to the fact that many of said parts are subjects of patents, or enter into patented combinations, and that in furnishing these parts at list prices we only license their use for repairing machines of our own make, in their original condition.

Notice is hereby given that the sale of such parts by the purchaser, or the use thereof for changing over machines from one style to another, or for any other than BONA FIDE repair purposes, is an infringement, for which the seller or user will be liable to prosecution.

Contents

The matter of this catalog relates only to machines in Class 7800, and cannot be applied to other classes. Puller parts and power transmitter parts are listed in two separate catalogs, Nos. 32 and 29 respectively, copies of which will be supplied upon request.

	PAGE
Important Notice to Customers	3
Description of Machines.....	5
Styles of Machines.....	5
Illustrations and Price List of Parts, Explanation of	7
Needles.....	6
Needle Prices.....	6
Plates.....	8
Price List of Parts.....	21
List of Parts.....	22

Description of Machines

A NAME PLATE is attached to each machine on which is stamped the class number. The class number represents the general type of machine.

THE STYLE is indicated by the letter following the class number and is given only in the catalog. It represents a sewing machine fitted to meet a specific condition.

THE GAUGE NUMBER of two needle machines represents the space between the rows of stitching.

The spacing of gauges is as follows:

Gauge No.	Space	Gauge No.	Space	Gauge No.	Space
5 9/32 inch	6 13/32 inch	48 3/4 inch

Styles of Machines in Class 7800

Large Arm Flat Bed Two Needle Miscellaneous Machines, Two Under Threads,
Left Hand Needle In Front, Long Needles

Style

7800 A—For lap seaming selvage edge tent and awning work; a folder for raw edge work will be furnished gratis, if the need is urgent (specify gauge of machine).

7800 B—For double lap seam felling tent and awning work; a guide for selvage edge work will be furnished gratis, if the need is urgent (specify gauge of machine and catalog number of folder).

7800 C—For lap seaming selvage edge tent and awning work; WITH PULLER, a folder for raw edge work will be furnished gratis, if the need is urgent (specify gauge of machine).

7800 D—For double lap seam felling tent and awning work; WITH PULLER, a guide for selvage edge work will be furnished gratis, if the need is urgent (specify gauge of machine and catalog number of folder).

Needles

ORDERING To simplify the ordering of needles, we have adopted a plan by which "TYPE" numbers will represent the full description of needles with the exception of the size of the blade.

New "SIZE" numbers are also given which represent the size of blade in thousandths part of an inch.

When ordering needles it is only necessary to give the "TYPE" numbers, the new "SIZE" numbers and the amount required.

Machines in Class 7800 use Type 143 Needles. (Round Shank, No. 2 Bag, Double Groove, Round Point.)

Success in the operation of our machines can be assured only by the use of genuine Union Special needles, furnished by the Union Special Machine Company. Obviously, it is to our interest to maintain the reputation of our machines by furnishing the very best needles obtainable.

TERMS Prices on needles are strictly net. Leaving the factory in perfect condition, packed with skillful care, they are forwarded at the buyer's risk, f.o.b. Regular postage rates will be charged on all needles sent by parcel post. To safeguard against loss in the mail, parcel post packages will be insured at the buyer's expense when so requested in the order.



VIEW OF NEEDLE, TYPE 143.

Type Number	New Size No.	Old Size No.	DESCRIPTION	Price per M ¹
143	067	6	No. 2 Bag, Double Groove, Nickel Plated.....	\$25.00
143	080	8	" " " " " " " "	25.00
143	090	9	" " " " " " " "	26.00
143	100	10	" " " " " " " "	27.50
143	140	14	" " " " " " " "	33.50

Illustrations and List of Parts for Repairs Only

PLATES Grouped according to scale will be found illustrations of parts similar in appearance and, to some extent, component parts that go together in the same subdivisions of the mechanism.

LIST OF PARTS Turning from the plates to the list of parts, will be found the parts numbers, plates they appear on and their names. Only the actual name of the part is given, as it was our aim in making up this catalog, to make it as concise as possible.

(‡) A double dagger in the "number to order by" column indicates that the component parts cannot be furnished separately.

(*) A star in the "number to order by" column indicates that the part can only be furnished upon return of the broken or worn out part. We are forced to adopt this rule because of the difficulty of protecting our customers and ourselves against improper use of these particular parts, which, like others, are furnished at list prices for repairs only.

ORDERING GOODS A large number of parts have their full numbers stamped upon them. Other parts, difficult to distinguish, are marked, instead, with identification letters. If customers furnished the number stamped on a piece, errors will be avoided, and we shall be enabled promptly to duplicate the desired part. All part numbers represent the same part regardless of the catalog in which they appear. All supplies, including oil, belting, belt fasteners, taps, reamers, screw drivers and powdered oilstone, will be promptly furnished.

TERMS Attention is directed to our established practice. Prices on parts and supplies are strictly net. Being shipped in perfect condition, packed with skillful care, they are forwarded at the buyer's risk, f.o.b. We cannot be responsible for delivery of mail packages. Regular postage rates will be charged on all goods sent by parcel post. To safeguard against loss in the mail, parcel post packages will be insured at the buyer's expense when so requested in the order.

CLASS 7800

Actual Size

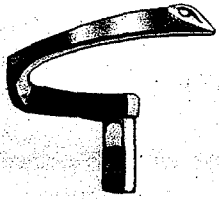

178 B-6

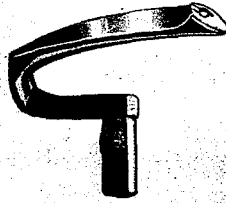

178 B-5



7809-48

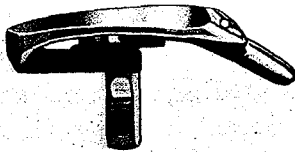

178

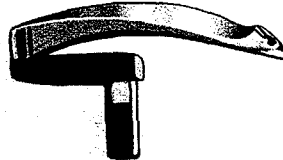

7408-48

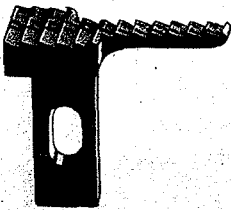

197 Y

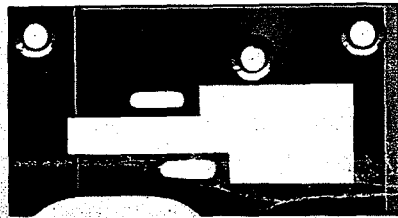

195 Y-6

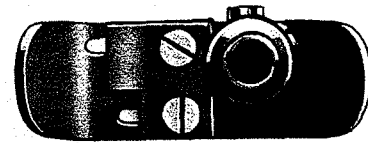

7827 A-6

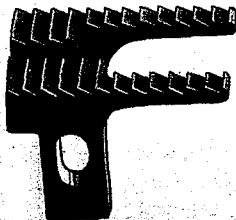

7805 A-5

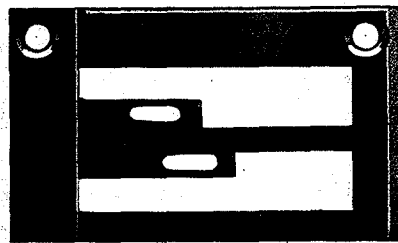

7824 A-5

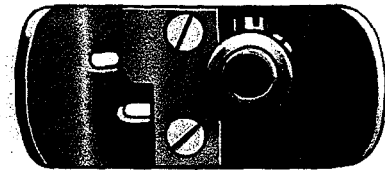

7827 A-5

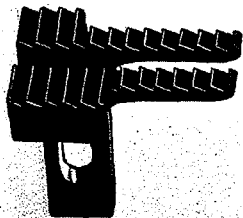

7805 A-48

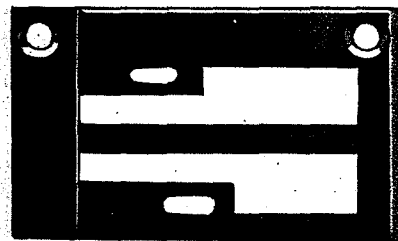

7824 A-48

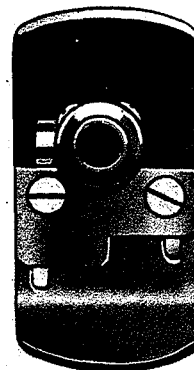

7827 A-48

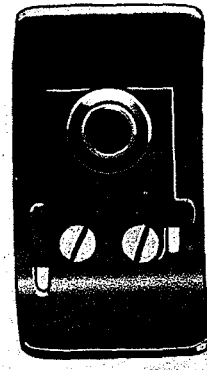

7827 C-48

CLASS 7800

Actual Size

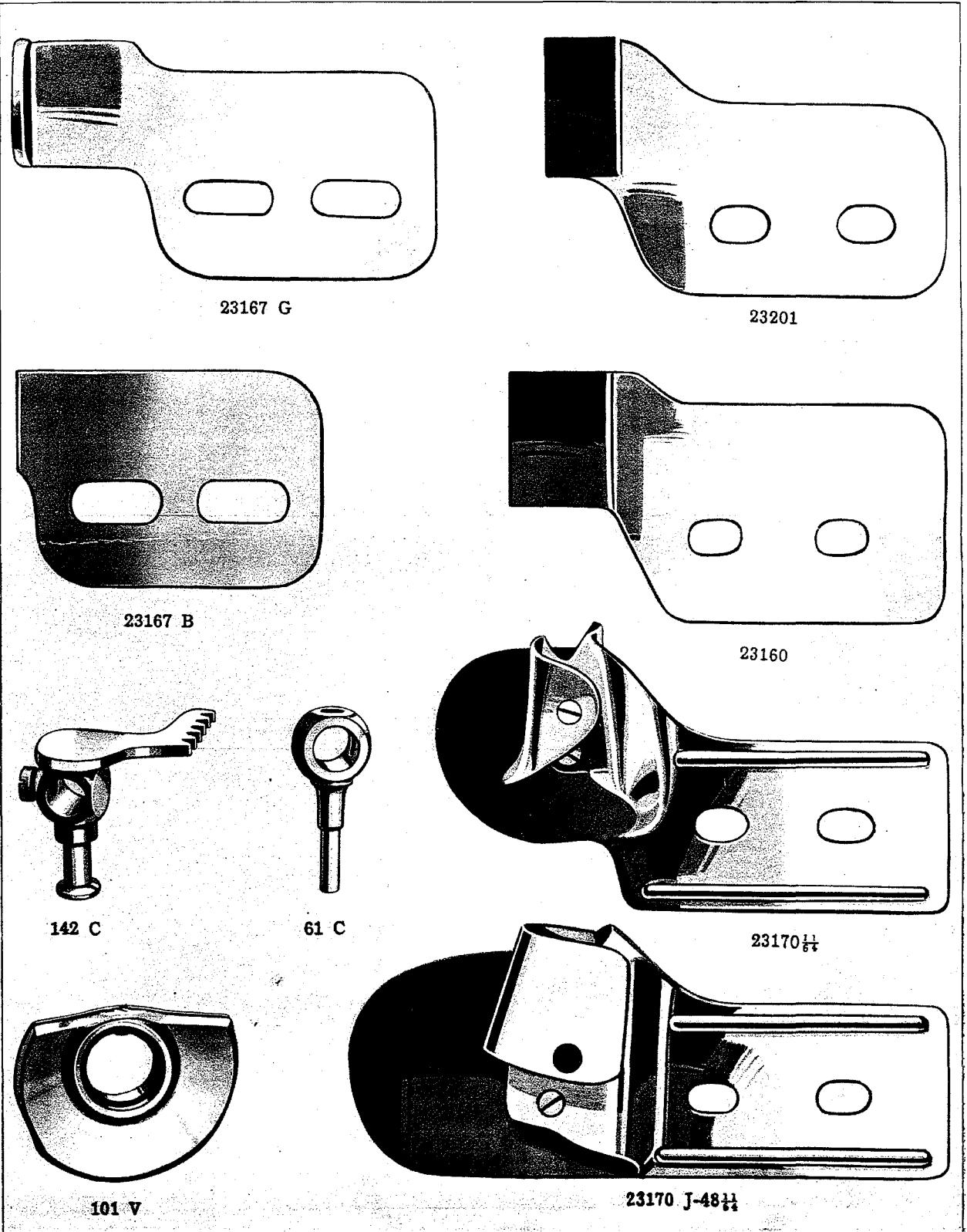

CLASS 7800

Actual Size



38 X



6606

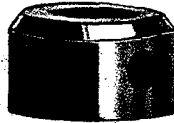

5



6093



15465 F



12873



12873 A



7825 A

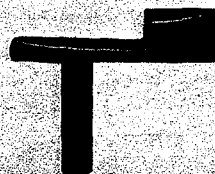

7825 B



2538

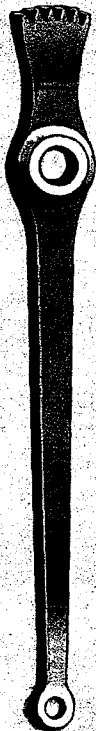

139 A



103 A



16



1286



194



1230 C



11262



202 A



68

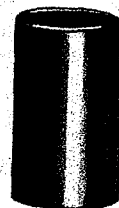

67

CLASS 7800

Actual Size

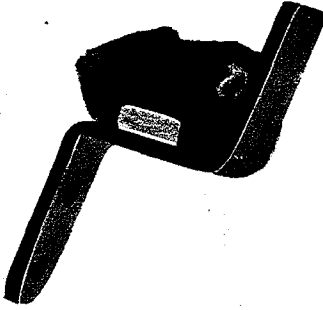

10 X

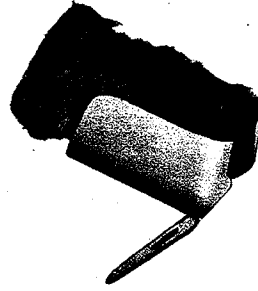

70

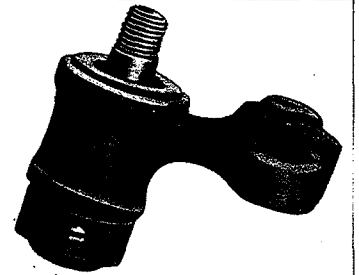

29157 A

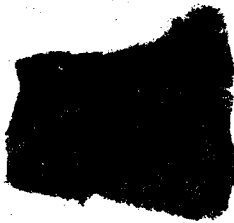

10 A



70 A

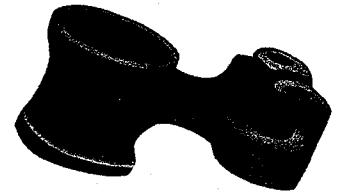

183 A

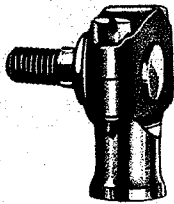

6039

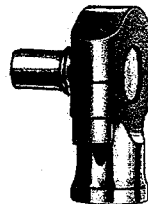

6038 B

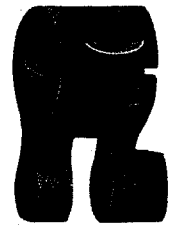

15

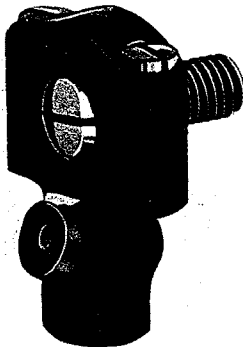

29066 B

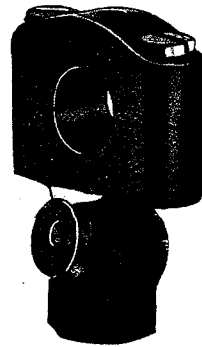

1230

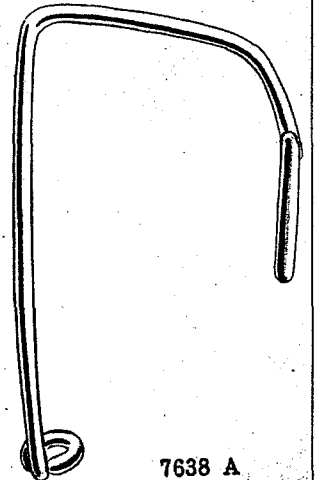

7638 A

CLASS 7800

Actual Size

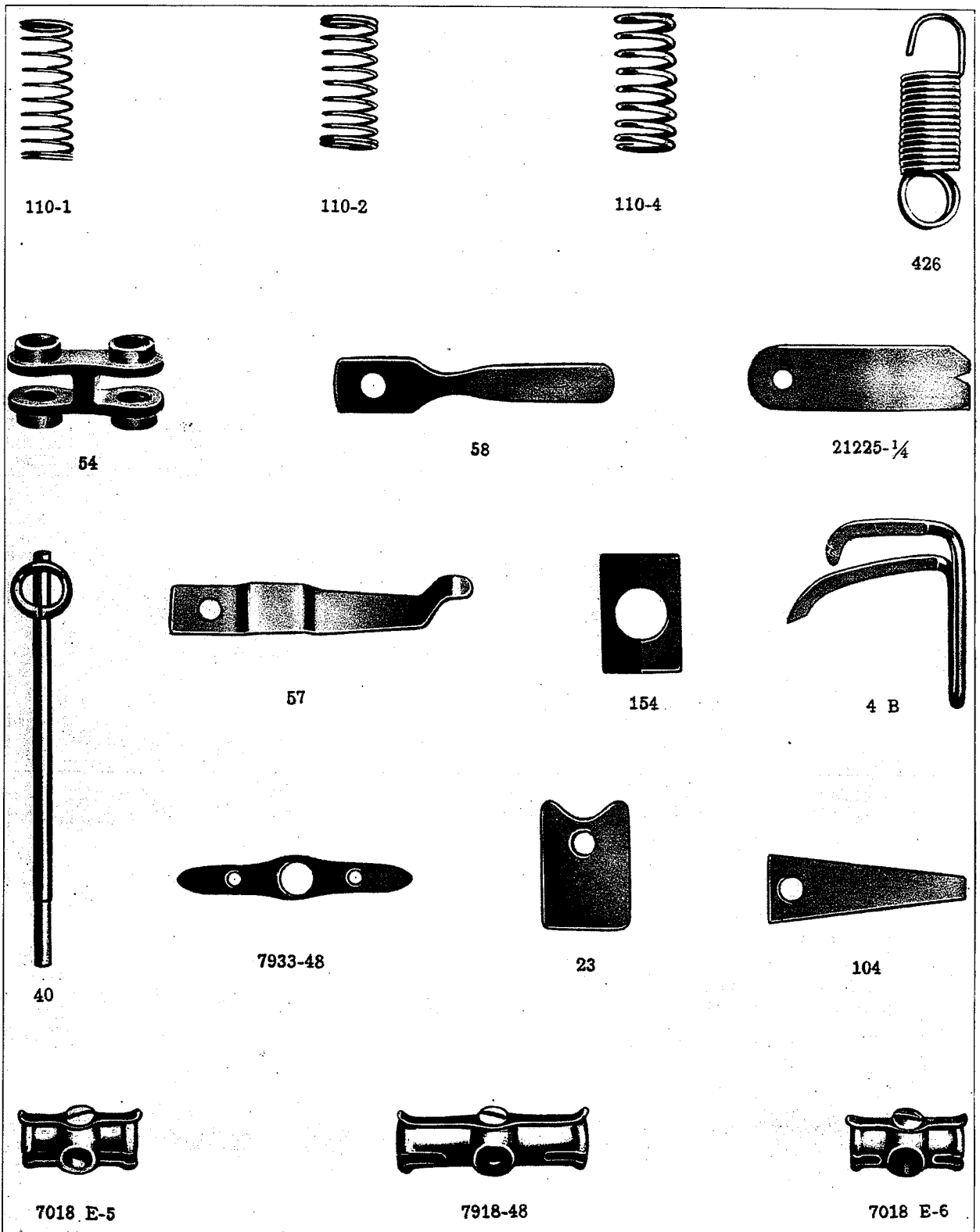

CLASS 7800

Actual Size



158



137



10335



10334



10334 A



107



109



48



20



158 E



11261 B



11261 A



1347



1346

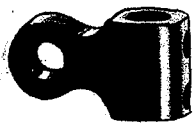

162



143 B



108



106 A

CLASS 7800

Actual Size

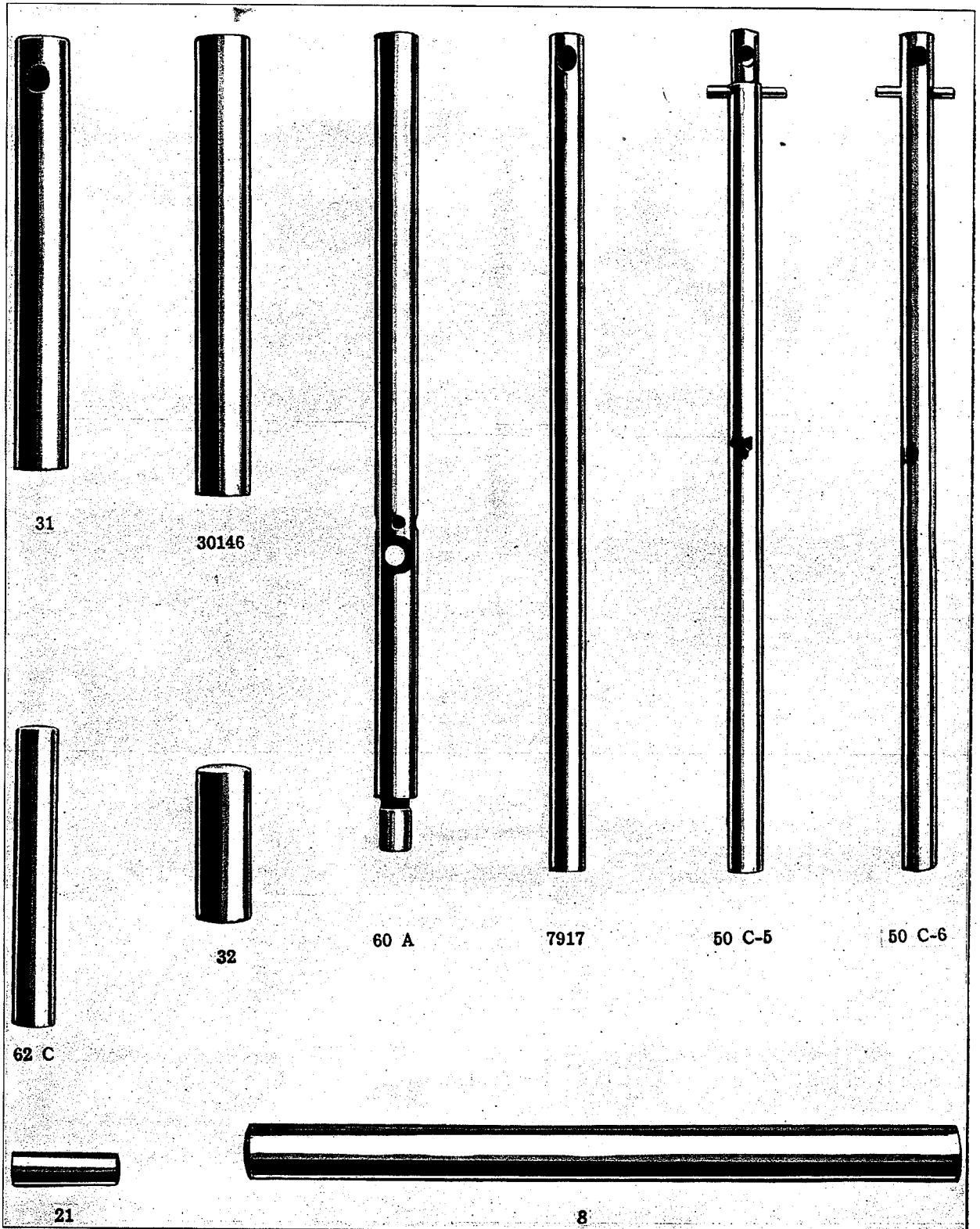

CLASS 7800

Actual Size

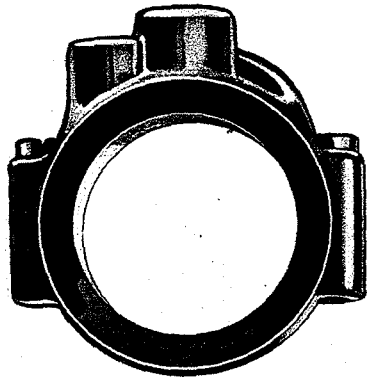

15430 M

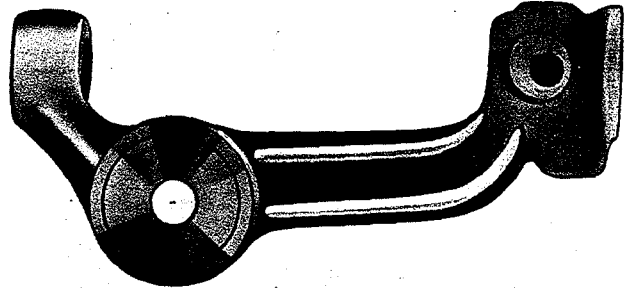

1261

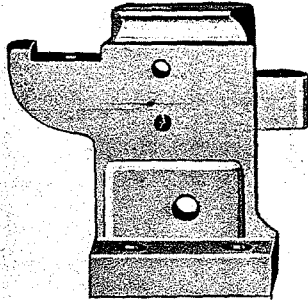

102

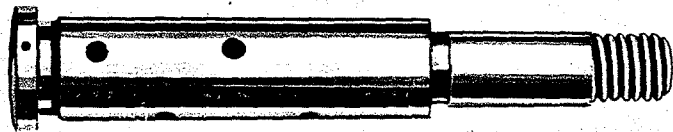

1275 A

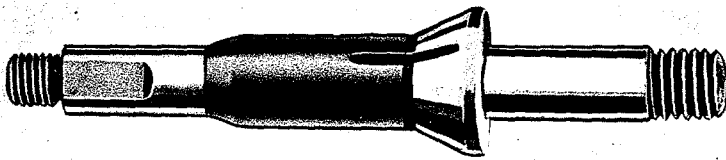

1276

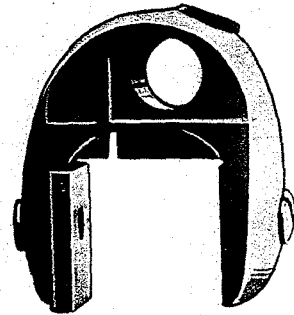

6 A

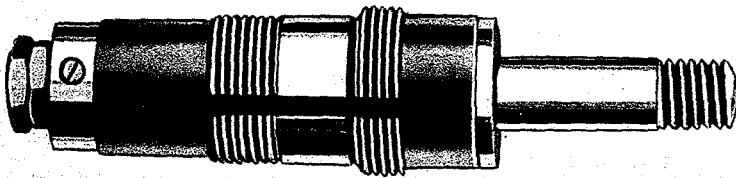

29304 E

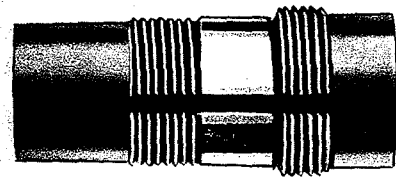

6090 A

Plate .

CLASS 7800

1/2 Size

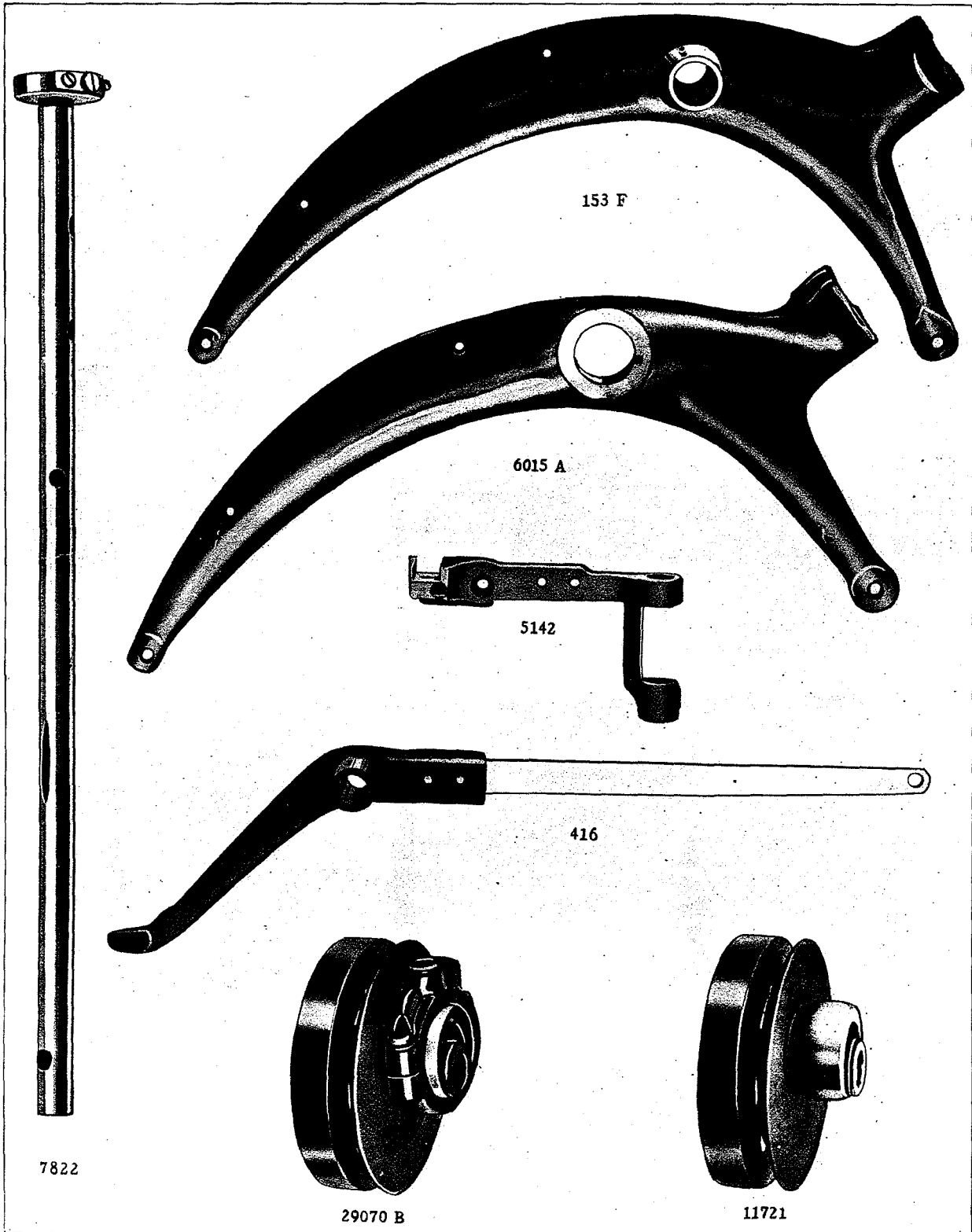

late 11

CLASS 7800

1/2 Size

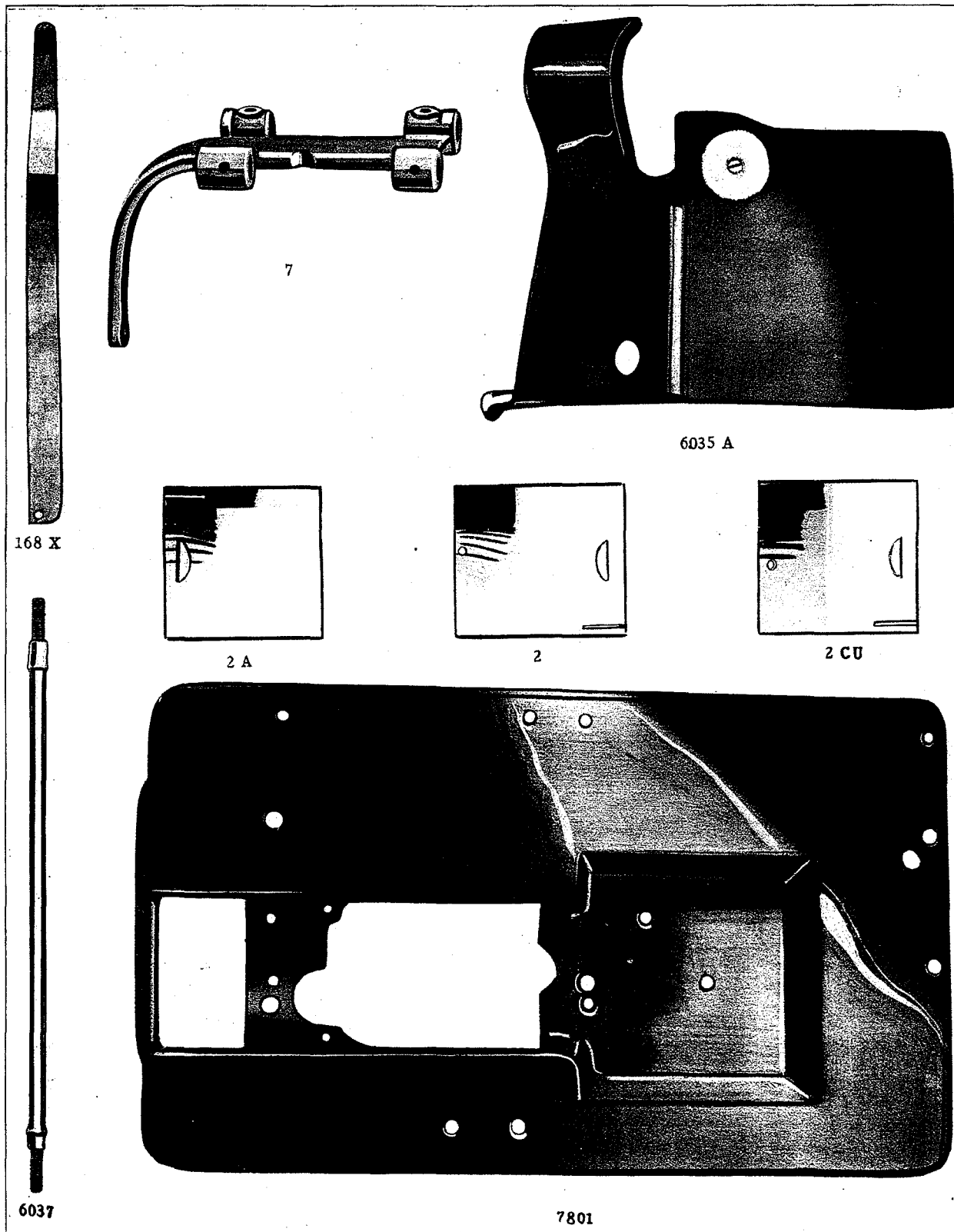

CLASS 7800

1/2 Size

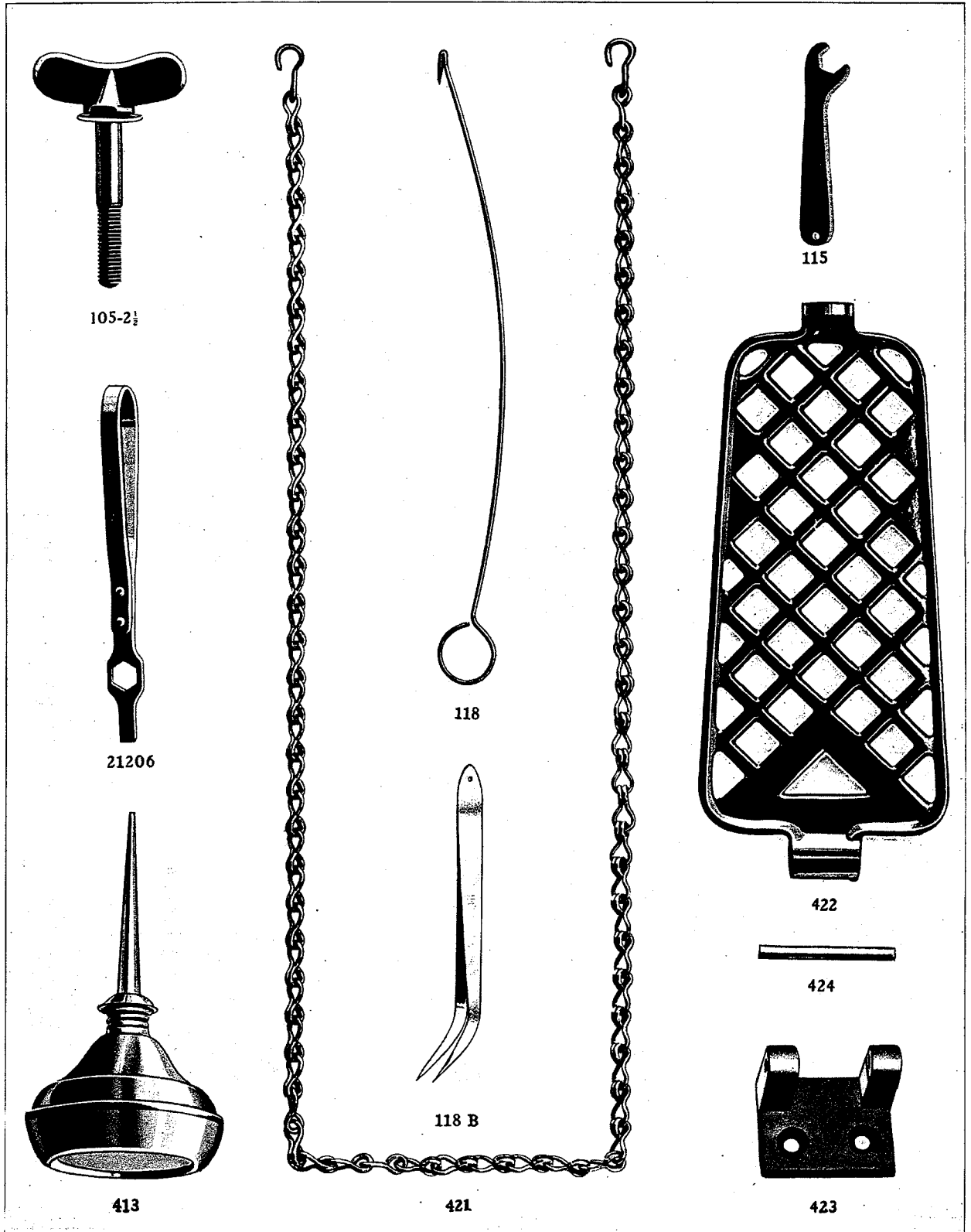

CLASS 7800

1/2 Size

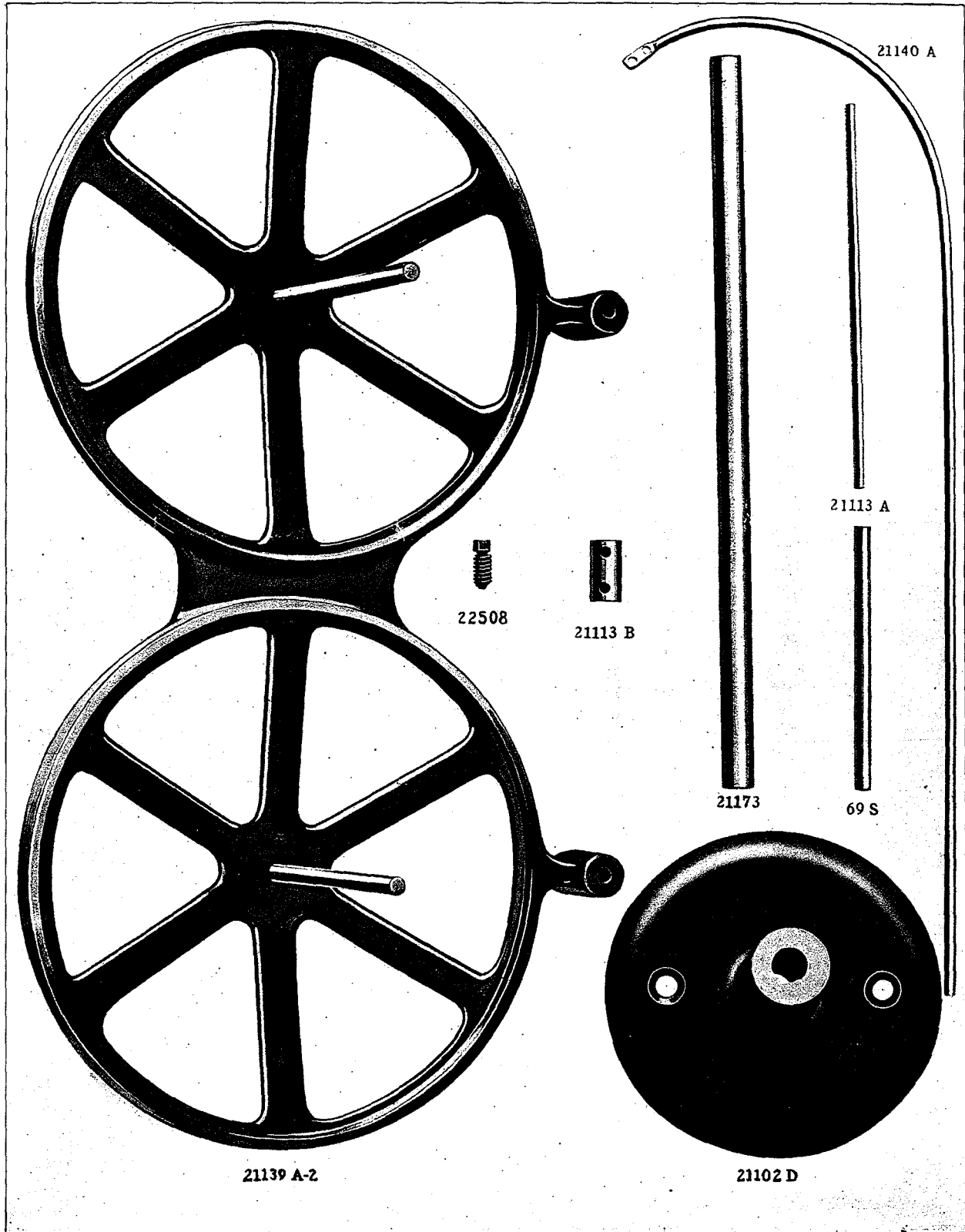

Price List of Parts

Class 7800

Effective February 23, 1920.

Supersedes all previous lists.

Prices subject to change without notice.

Number	Price	Number	Price	Number	Price	Number	Price
2	\$0.80	89	\$0.06	421	\$0.30	7917	\$3.00
2 A	.80	90	.08	422	.40	7918-48	2.20
2 CU	.80	93	.08	423	.30	7933-48	.50
4 B	.60	93 A	.08	424	.10	10334	.16
5	.50	94	.08	426	.10	10334 A	.16
6 A	1.50	95	.06	605 A	.10	10335	.20
6 B	.20	96	.06	1230	2.00	11261 A	.50
7	2.00	97	.08	1230 A	1.70	11261 B	.20
8	.90	98	.06	1230 C	.60	11262	.20
10 A	.04	98 A	.08	1261	2.00	11638 M	.20
10 X	.40	101 V	1.50	1275 A	2.90	11721	4.50
15	.80	102	1.00	1276	2.00	12873	.50
16	.60	103 A	.50	1280	.20	12873 A	.50
17 X	.50	104	.10	1286	.60	12987 A	.20
18	.20	105-2½	.30	1346	.40	15430 C	.20
20	.06	106 A	.50	1347	.16	15430 D	.20
21	.20	107	.12	1361	.06	15430 L	.04
23	.30	108	.10	1362	.06	15430 M	1.50
25 C	.10	109	.10	2538	.60	15465 F	1.00
31	.90	110-1	.08	5142	1.50	15745 B	1.60
32	.60	110-2	.08	6015 A	4.50	21102 D	.80
38 X	1.00	110-4	.10	6035 A	2.00	21113 A	.10
40	.20	115	.20	6037	1.00	21113 B	.30
42 A	.20	118	.10	6038 B	2.50	21139 A-2	2.00
47	.40	118 B	.40	6039	2.50	21140 A	.20
48	.06	137	.20	6042	.40	21173	.30
50 C-5	3.00	138	.08	6090 A	3.50	21206	.30
50 C-6	3.00	139 A	2.00	6091	.50	21225¼	.40
54	1.50	142 C	1.50	6091 A	.80	22508	.06
57	.20	143 B	.12	6092	.20	22514	.16
58	.16	150	.08	6093	1.20	22524	.10
60 A	1.50	153 F	4.50	6606	1.20	22539	.20
61 C	.70	154	.10	7018 E-5	1.40	22569	.10
62 C	.80	156	.80	7018 E-6	1.40	22586	.10
64 B	.20	158	.20	7408-48	4.00	22587	.10
64 X	.40	158 B	.24	7638 A	.30	22596	.08
67	.24	162	.80	7801	5.00	22730	.10
68	.30	168 X	.70	7805 A-5	2.50	22768	.08
69 S	.20	178	2.90	7805 A-48	3.00	23160	1.20
70	.20	178 B-5	2.50	7809-48	4.00	23167 B	.80
70 A	.04	178 B-6	2.50	7822	5.00	23167 G	1.40
72	.10	183 A	2.50	7824 A-5	3.00	23170 ¹¹ / ₆₄	6.00
73	.10	194	1.20	7824 A-48	4.00	23170 J-48 ¹¹ / ₆₄	8.00
77	.06	195 Y-6	3.00	7825 A	3.00	23201	1.20
78	.06	197 Y	2.00	7825 B	3.00	29066 B	3.30
79	.08	202 A	.70	7827 A-5	3.50	29070 B	6.50
80	.10	269	.20	7827 A-6	3.50	29157 A	6.00
86	.10	413	.20	7827 A-48	4.00	29304 E	7.70
88	.06	416	1.50	7827 C-48	5.00	30146	1.20
88 A	.08	420	.40				

List of Parts

Class 7800

In ordering from this list, use ONLY the PART number in the first column.

The figures in the second column refer only to the plate illustrating the parts and are NOT to BE used in ordering.

Number	Plate	Name	Number	Plate	Name
2	11	Cloth Plate Slide, right.	95	5	Screw.
2 A	11	Cloth Plate Slide, left.	96	5	Spot Screw.
2 CU	11	Cloth Plate Slide, right.	97	5	Screw.
4 B	6	Cast-off Wire.	98	5	Screw.
5	3	Collar for Main Shaft.	98 A	5	Screw.
6 A	9	Looper Eccentric Fork, with shoes.	101 V	2	Looper Thread Take-up.
6 B	..	Looper Eccentric Fork Shoe.	102	9	Looper Thread Take-up Frame.
7	11	Feed Rocker.	103 A	3	Looper Thread Take-up Thread Eyelet.
8	8	Feed Rocker Shaft.	104	6	Looper Thread Take-up Thread Eyelet Spring
10 A	4	Feed Bar Prong Sponge.	105-2½	12	Machine Thumb Screw.
10 X	4	Feed Bar Prong and Sponge.	106 A	7	Tension Post (1½ inches long).
15	4	Feed Crank Link.	107	7	Tension Spring Ferrule.
16	3	Feed Crank Link Ferrule.	108	7	Tension Nut.
17 X	5	Feed Crank Stud.	109	7	Tension Disc.
18	5	Feed Crank Stud Nut.	110-1	6	Tension Spring.
20	7	Feed Crank Stud Washer.	110-2	6	Tension Spring.
21	8	Feed Crank Link Pin.	110-4	6	Tension Spring.
23	6	Feed Bar Shoe.	115	12	Wrench.
25 C	5	Screw.	118	12	Thread Hook.
31	8	Looper Rock Shaft, long.	118 B	12	Thread Tweezers.
32	8	Looper Rock Shaft, short.	137	7	Thread Controller Thread Eyelet.
38 X	3	Looper Eccentric.	138	5	Thread Controller Thread Eyelet Screw.
40	6	Lower Thread Eyelet.	‡ 139 A	3	Thread Controller Lever and Washer, assembled.
42 A	5	Lifter Screw Pin.	142 C	2	Thread Controller Rack and Presser Spring Rest.
47	5	Needle Lever Stud Nut.	143 B	7	Needle Thread Pull-off and Take-up Wire.
48	7	Needle Lever Stud Washer.	150	5	Cloth Plate Slide Stop Screw.
* 50 C-5	8	Needle Bar.	153 F	10	Needle Lever.
* 50 C-6	8	Needle Bar.	154	6	Needle Lever Washer.
54	6	Needle Bar Link.	156	5	Needle Lever Ball.
57	6	Looper Thread Nipper Spring, upper.	158	7	Needle Lever Thread Eyelet, right.
58	6	Looper Thread Nipper Spring, lower.	158 B	7	Needle Lever Thread Eyelet, left.
60 A	8	Presser Bar.	162	7	Needle Bar Connection.
61 C	2	Presser Bar Connection.	168 X	11	Presser Spring.
62 C	8	Presser Guide Bar.	178	1	Looper, front, with guard.
64 B	5	Presser Spring Screw Regulator Check Nut.	178 B-5	1	Looper, rear.
64 X	5	Presser Spring Screw Regulator.	178 B-6	1	Looper, rear.
67	3	Main Shaft Sleeve, short.	* 183 A	4	Looper Rocker.
68	3	Main Shaft Sleeve, long.	194	3	Presser Foot Lifter.
69 S	13	Spool Pin.	195 Y-6	1	Throat Plate.
70	4	Looper Eccentric Sponge Holder and Sponge.	197 Y	1	Feed Dog.
70 A	4	Looper Eccentric Sponge.	202 A	3	Needle Thread Take-up Post.
72	5	Set Screw.	269	5	Nut, left thread.
73	5	Set Screw, for looper.	413	12	Oil Can.
77	5	Screw.	416	10	Foot Lift Lever.
78	5	Set Screw, for link pin.	420	5	Foot Lift Lever Stud.
79	5	Screw.	421	12	Foot Lift Chain, 38 inches long.
80	5	Screw.	422	12	Foot Lift Treadle.
86	5	Screw.	423	12	Foot Lift Treadle Rest.
88	5	Screw.	424	12	Foot Lift Treadle Pin.
88 A	5	Screw.	426	6	Foot Lift Lever Spring.
89	5	Screw.	605 A	5	Screw.
90	5	Screw.	1230	4	Needle Lever Connection Bearing, upper, with spring and ball.
93	5	Screw (⅜ inch long).	‡ 1230 A	..	Needle Lever Connection Bearing, without spring and ball.
93 A	5	Screw (⅜ inch long).			
94	5	Screw (½ inch long).			

List of Parts

Class 7800

In ordering from this list, use ONLY the PART number in the first column.

The figures in the second column refer only to the plate illustrating the parts and are NOT to BE used in ordering.

Number	Plate	Name	Number	Plate	Name
1230	C	3 Needle Lever Connection Bearing Tube.	11261	A	7 Tension Post.
1261		9 Looper Rocker Frame, without cone.	11261	B	7 Tension Post Ferrule.
1275	A	9 Needle Lever Stud.	11262		3 Tension Thread Guide, with two eyes.
1276		9 Needle Lever Stud, cone bearing.	11638	M	5 Nut.
1280		5 Needle Lever Bolt Nut.	11721	10	Pulley.
1286		3 Needle Bar Link Pin, complete.	12873		3 Bushing, long.
1346		7 Tension Post.	12873	A	3 Bushing, short.
1347		7 Tension Post Ferrule.	12987	A	5 Nut.
1361		5 Presser Spring Pin.	15430	C	5 Nut, left thread.
1362		5 Main Shaft Sleeve Pin.	15430	D	5 Nut, right thread.
2538		3 Thread Controller Rack Supporting Collar.	15430	L	5 Needle Lever Connection Tube Felt.
5142	10	Feed Bar.	†15430	M	9 Needle Lever Connection Bearing, lower.
6015	A	10 Needle Lever.	15465	F	3 Looper Rocker Cone.
6035	A	11 Needle Lever Guard.	15745	B	5 Looper Rocker Cone Stud.
6037		11 Looper Connection Rod.	21102	D	13 Base, for thread stand.
6038	B	4 Ball Joint, left.	21113	A	13 Thread Wire Extension (six inches long).
6039		4 Ball Joint, right.	21113	B	13 Thread Wire Coupling.
6042		5 Needle Lever Bolt.	21139	A-2	13 Spool Support.
6090	A	9 Needle Lever Hub.	21140	A	13 Thread Wire (fifteen inches long).
6091		5 Needle Lever Hub Nut, hexagonal.	21173		13 Rod, for thread stand.
6091	A	5 Needle Lever Hub Nut, cylindrical.	21206		12 Screw Driver Wrench, steel handle.
6092		5 Needle Lever Hub Key.	21225- $\frac{1}{4}$		6 Looper Gauge.
6093		3 Needle Lever Stud Cone.	21384	A	5 Leather Plug.
6606		3 Feed Lift Cam.	22508		13 Set Screw.
7018	E-5	6 Needle Holder.	22514		5 Screw.
7018	E-6	6 Needle Holder.	22524		5 Screw.
7408-48		1 Looper, rear.	22539		5 Screw.
7638	A	4 Lower Thread Deflecting Wire.	22569		5 Clamp Screw.
7801		11 Cloth Plate.	22586		5 Screw.
7805	A-5	1 Feed Dog.	22596		5 Screw ($\frac{5}{8}$ inch long).
7805	A-48	1 Feed Dog.	22587		.. Screw, for Nos. 1230 and 15430 M.
7809-48		1 Looper, rear.	22730		5 Screw.
7822		10 Main Shaft.	22768		5 Screw.
7824	A-5	1 Throat Plate.	23160		2 Double Lap Seam Guide.
7824	A-48	1 Throat Plate.	23167	B	2 Lap Seam Guide, lower part.
7825	A	3 Feed Bar Needle Guard (marked BP).	23167	C	2 Lap Seam Guide, upper part.
7825	B	3 Feed Bar Needle Guard (marked DA).	23170 $\frac{11}{16}$		2 Double Lap Seam Feller.
7827	A-5	1 Presser Foot.	23170	J-48 $\frac{11}{16}$	2 Double Lap Seam Feller.
7827	A-6	1 Presser Foot.	23201		2 Double Lap Seam Guide, non-adjustable.
7827	A-48	1 Presser Foot.	29066	B	4 Nos. 1230 and 156 assembled and lapped together.
7827	C-48	1 Presser Foot.	29070	B	10 Nos. 11721 and 15430 M assembled and lapped together.
7917		8 Needle Bar.	29157	A	4 Nos. 183 A, 12987 A, 15465 F, 15745 B and two No. 88 assembled and lapped together.
7918-48		6 Needle Clamp Collar.	29304	E	9 Nos. 1276, 6090 A, 6093 and two Nos. 88 and 11638 M assembled and lapped together.
7933-48		6 Needle Stop Plate.	30146		8 Feed Bar Shaft.
10334		7 Needle Bar Thread Eyelet, short.			
10334	A	7 Needle Bar Thread Eyelet, long.			
10335		7 Tension Thread Guide.			

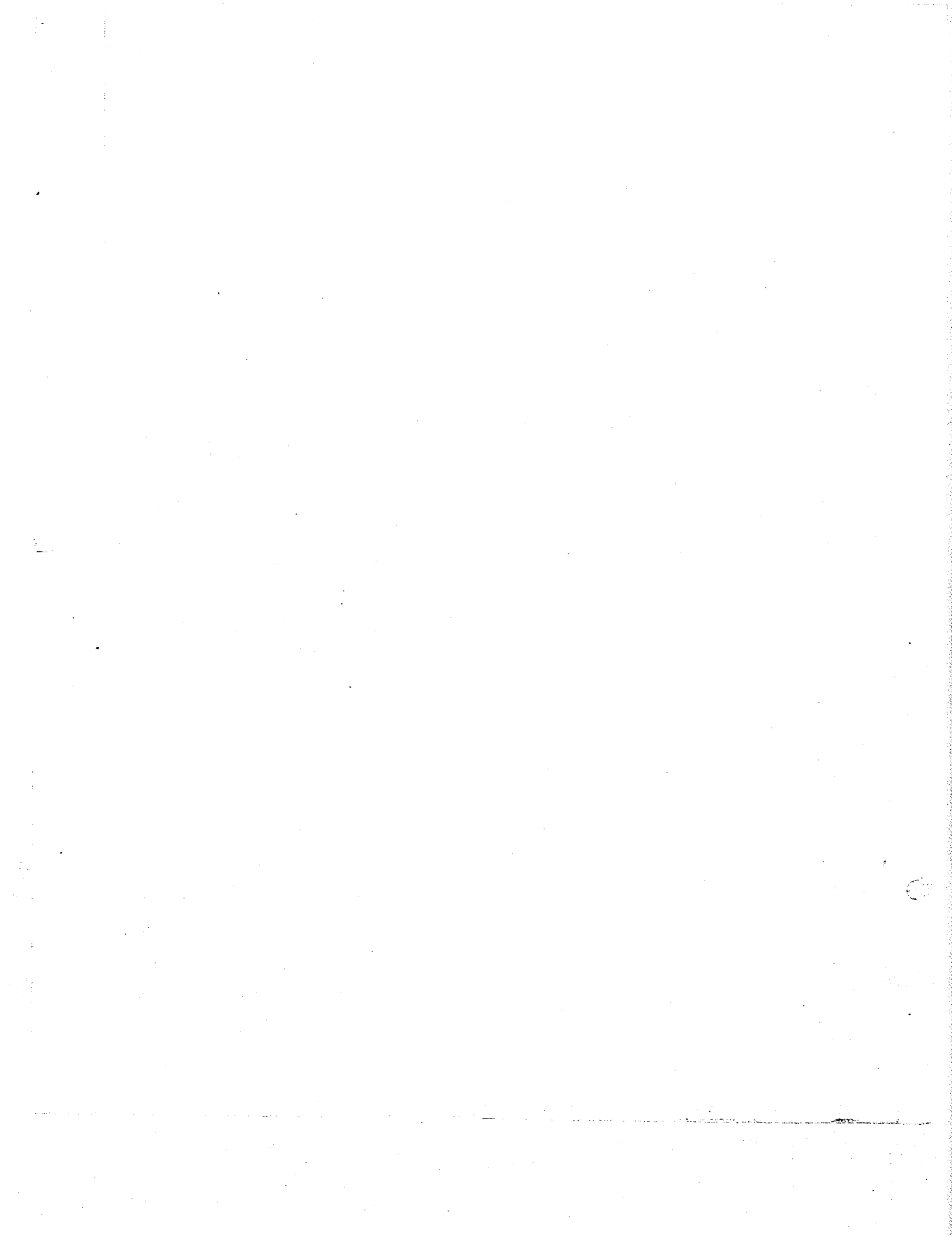



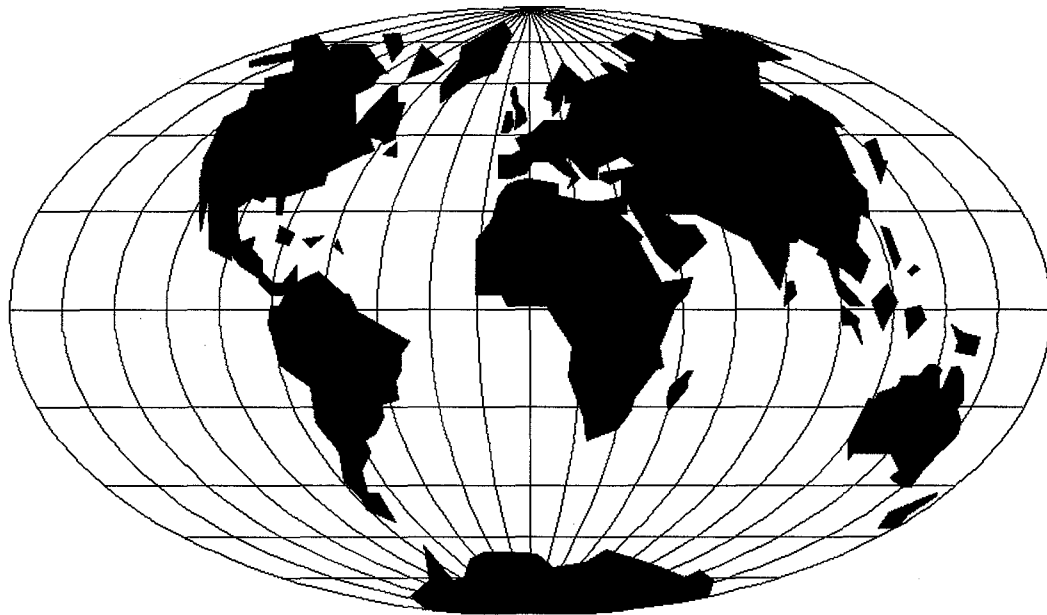

WORLDWIDE SALES AND SERVICE

Union Special Corporation maintains sales and service facilities throughout the world. These offices will aid you in the selection of the right sewing equipment for your particular operation. Union Special Corporation representatives and service technicians are factory trained and are able to serve your needs promptly and efficiently. Whatever your location, there is a qualified representative to serve you.

Corporate Office: One Union Special Plaza
Huntley, IL 60142
Phone: 708•669•5101
Fax: 708•669•1096

European Distribution Center: Union Special GmbH
Raiffeisenstrasse 3
D-71696 Möglingen, Germany
Tel: 49•07141•247•0
Fax: 49•7141•247•100

Brussels, Belgium
Charlotte, N.C.
Commerce, CA
El Paso, TX
Hong Kong, China
Huntley, IL
Leicester, England
Lille, France
Miami, FL
Milan, Italy
Mission, TX
Möglingen, Germany
Montreal, Quebec
Osaka, Japan

Other Representatives throughout
all parts of the world.



Union Special
INDUSTRIAL SEWING EQUIPMENT