



*Union Special*  
INDUSTRIAL SEWING EQUIPMENT

**STYLES**

**ADJUSTING INSTRUCTIONS AND  
ILLUSTRATED PARTS LIST**

**52700**

**52800**

**52900**

**53500**

---

---

**LIST OF PARTS AND INSTRUCTION**

---

---

**CATALOG  
NO. 80L**

**FIRST  
EDITION**

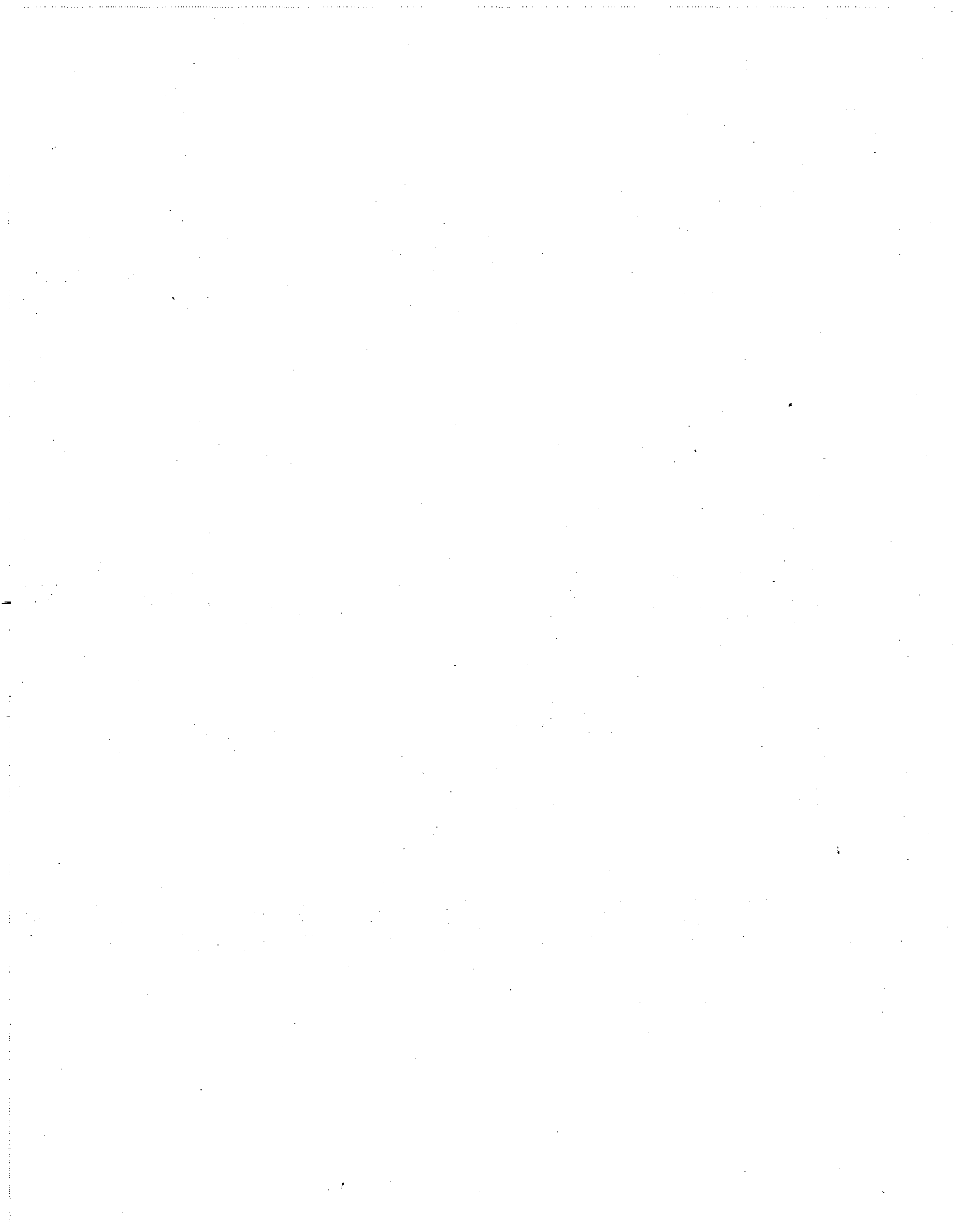

Catalog No. 80 L  
THE FIFTY THOUSAND SERIES  
LIST OF PARTS

STYLES IN CLASSES

52700      52800

52900      53500

The parts listed in this Catalog are  
furnished at list prices for repairs only.

First Edition

Price \$2.00

Copyright 1938  
By  
Union Special Machine Co.  
Rights Reserved In All Countries

Union Special Machine Company  
Chicago

Printed in U.S.A.



# Union Special®

INDUSTRIAL SEWING MACHINES

## • Africa

BULAWAYO, SO. RHODESIA, FEDERATION OF RHODESIA and NYASALAND, Berzack Bros. Ltd., 16 14th Avenue. (Textile Machines).  
 CASABLANCA, MOROCCO, Etablissements Geissmann & Fils, 34 Blvd. de la Gare.  
 JOHANNESBURG, UNION OF SOUTH AFRICA, South African Scale Co., (Pty.) Ltd., P.O. Box 1463, 32 Van Brandis St., for bag closing machines. Branches also at Bloemfontein, (53 Zaston St.), Capetown, (Box 779), Durban, (22 Aliwal St.), East London (53A Cambridge St.) Pietermaritzburg, Port Elizabeth, (Box 611), Pretoria, Vereeniging and Worcester.  
 JOHANNESBURG, UNION OF SOUTH AFRICA, Berzack Bros. Ltd., Berbro House, 135/7 Pritchard St. Branches also at 487 West St., Durban; 78 Darling St., Capetown; 58 Queen St., Port Elizabeth. Textile machines.  
 MAURITIUS, Hall, Geneve, Langlois, Ltd., Port Louis, P.O. Box 77.  
 SALISBURY, SO. RHODESIA, FEDERATION OF RHODESIA and NYASALAND, So. African Scale Co., Corner of Forbes and Angwa Sts., Bag Closing Machines.

## • Asia

CALCUTTA, INDIA, Don Watson & Co., Ltd., 19 British Indian St.  
 Dacca, PAKISTAN, Roberts & McLean & Co., Ltd., 91 Nawabpur Rd., Bag closing and Bag seaming machines.  
 DELHI 6, INDIA, Munshi Ram Bs. C., P.O. Box 1114, Kashmere Gate. Above Keventers.  
 HONGKONG, G. R. Coleman Co. (Hongkong) Ltd., Room 308, Bank of Canton Bldg., 6 Des Voeux Road, Central.  
 KARACHI 2, PAKISTAN, Universal Trading Corp., Textile Machines, 29 Zeenat Mansion, McLeod Road, P.O. Box 4635.  
 OSAKA, JAPAN, Mima Sewing Machine Mfg. Co., 29, 1-chrome, Ebi-kami, Fukushima—KU.  
 SEOUL, KOREA, Uebersee-Handel A. G., Iwang Wha Moon, P.O. Box 268.  
 TAIPEI, TAIWAN, G. R. Coleman, Hongkong, Ltd., 78 Po Ai Road.  
 TOKYO, JAPAN, Iwase Sewing Machine Co., Ltd., 39, 1-chrome, Kamezawa-cho, Sumida—KU.

## • Australia

BRISBANE, AUSTRALIA, Capron, Carter (Pty.) Ltd., Rm. 55—Rex Bldg., Wickham St., Valley.  
 MELBOURNE, VICT., AUSTRALIA, Capron, Carter (Pty.) Ltd., 78 A'Beckett St.  
 SYDNEY, N.S.W., AUSTRALIA, Capron, Carter (Pty.) Ltd., 86 Liverpool St.

## • British West Indies

KINGSTON, JAMAICA, B. W. I., Mr. Morris E. Parkin, 102 King St.

## • Canada

Union Special Machine Co. of Canada, Ltd.  
 CALGARY, ALTA., 1809 24th Ave., N.W. N. W. Hall, Tel. 891690.  
 MONTREAL 14, QUE., 40 Moliere St., Clyde F. Amey, Tel. Victoria 2575.  
 QUEBEC, P. Q., Ave. Des Pins Ouest. Lucien Bouchard. Tel. 3-8126.  
 ★TORONTO 2, ONT., 135 Peter St. S. J. Storey, Mgr. Tel. Empire 6-2939.  
 WINNIPEG, MAN., Room 201, Whirla Bldg., Frank Thierman. Tel. 934933.

## • Europe

AMSTERDAM, THE NETHERLANDS, N. V. Machinehandel C. & H. Verbeek, Kloveniersburgwal 77. Also offices in: Rotterdam, Sittard, Groningen, Enschede, Eindhoven.  
 ATHENS, GREECE, Michel D. Dimoulis, Rue Deka, 4A.  
 BARCELONA, SPAIN, Raaida, S. A. Avino 9.  
 BERGEN, NORWAY, Jac. Jacobsen A/S, Bjornsongst 24.  
 BORAS, SWEDEN, Rud. Nystrom & Co., A/B, Lilla Bannerigatan 6.  
 BRUSSELS, BELGIUM, Union Special Machine Corporation of America, 23 Rue Philippe de Champagne. Henri Deloof, Mgr.

COPENHAGEN, DENMARK, Rothenborg Special-maskiner for Sy-Industrian A/S, Nikolaj Plads 23. Also offices in: Herning, Kolding, Odense, Silkeborg, Rissakov.  
 DUBLIN, EIRE, Machines, Ltd., 24 Upper Abbey St. Textile Machines.  
 DUNDEE, SCOTLAND, Thomas C. Keay, Ltd., 15 Baltic St. Bag Closing and Bag Making.  
 HELSINKI, FINLAND, Suomen Koneliiike O/Y, Viihkonkatu 9.  
 LEICESTER, ENGLAND, Union Special Machine Co., Ltd., 25 Bede St. Braunstone Gate, A. B. Fitzpatrick, Mgr. Textile Machines.  
 LONDON, E. C. 1, ENGLAND, Union Special Machine Co., Ltd., Parksworth House, 30, City Road. Textile Machines.  
 MALMO, SWEDEN, Rud. Nystrom & Co., A/B Vargatan 10-A.  
 MILANO, ITALY, Giovanni Conti y Nipoti, Piazzale Masengo 6.  
 NOTTINGHAM, ENGLAND, Mr. W. Wilkes, Plantation Road, Wellaton. Textile Machines.  
 OPORTO, PORTUGAL, Rost & Janus, Succrs., Rua Barao de Forrester, 914.  
 OREBRO, SWEDEN, Rud. Nystrom & Co., A/B Skebacksvagen 17-19.  
 OSLO, NORWAY, Jac. Jacobsen A/S, Kr. Augustsgate 19 (Tullingarden).  
 PARIS, FRANCE, Cie. des Machines Union Special de France, 91 Avenue de la Republique, Georges Linotte, Mgr.  
 STOCKHOLM, SWEDEN, Rud. Nystrom & Co., A/B, St. Nygatan 10-12.  
 STUTTGART, GERMANY, Union Special Maschinenfabrik, G.m.b.h., Schwabstrasse 33, A. W. Krieger, Managing Director.  
 VIENNA, VI, AUSTRIA, Firma Nahschuster, Mariahilferstr. 51.  
 ZURICH, 9/47, SWITZERLAND, M. L. Bourquin, Albisriederstrasse 226.

## • Latin America

Union Special International, Inc.  
 BARRANQUILLA, COLOMBIA, C. Ceballos & Cia., Ltda., Almacenes "Carceco," Banco Comercial, Anticuano, OF. 401.  
 BOGOTA, COLOMBIA, C. Ceballos & Cia., Ltda., Avenida Caracas 17-18.  
 BUENOS AIRES, ARGENTINA, Kay, Grandjean & Cia., Bartolome Mitre 760.  
 CALI, COLOMBIA, C. Ceballos & Cia., Ltd., Calle 4, No. 9-21.  
 CARACAS, VENEZUELA, H. Blohm, S.A., Dr. Paul A. Charro 29.  
 CIUDAD TRUJILLO, DOMINICAN REPUBLIC, Luis Dominguez, Apartado 57, Hostos esq. El Conde.  
 GUADALAJARA, JAL., MEXICO, Talleres Perez Zozaya, S. A. Hidalgo 45 y 47.  
 GUATEMALA CITY, GUATEMALA, Cia. Agro Comercial S.A., 8a Ave. Sur. 10-43. Bag Closing Machines.  
 HAVANA, CUBA, Antilla Yarn & Supply Co., S. A. Factoria 70, Textile, Bag Seaming, and Shoe Machines.  
 HAVANA, CUBA, Mr. Miguel A. Vilato, Apartado No. 124, Bag Closing Machines.  
 LIMA, PERU, A. y F. Wiese, S.A., Esq. Nunez y Filipinas.  
 MANAGUA, NICARAGUA, Hentgen & Co., Ltd., Apartado 14. 5 A. Calle, N. O. 214.  
 MEDELLIN, COLOMBIA, C. Ceballos & Cia., Ltda., Carrera Junin 44-34.  
 MEXICO, D.F., MEXICO, Perez Zaragoza, S.A., Regina 26.  
 MONTERREY, N.L., MEXICO, Talleres Perez Zozaya, S.A., Apartado 197, Cuahatemac Norte 335.  
 MONTEVIDEO, URUGUAY, Carlos Dighiero e Hijos, Convencion 1424.  
 PORTO ALEGRE, RIO GRANDE DO SUL, BRAZIL, Casa de Maquinas Falk, Ltda., Rua Hoffman 533. Bag Closing and Bag Making Machines.  
 PORTO ALEGRE, RIO GRANDE DO SUL, Maquinas de Costura Panambra, S.A., Rua Siqueira de Campos 1172. Textile Machines.  
 RECIFE, PERNAMBUCO, Maquinas de Costura Panambra, S.A., Av. Guararapez 154. Textile Machines.

# REPRESENTATIVES

RIO DE JANEIRO, D.F., Maquinas de Costura Panambra, S.A., Rua Alexandre Mackenzie 117. Textile Machines.  
 SAN JOSE, COSTA RICA; Champion Co., Ltda., APDO. 2742.  
 SAN JUAN, PUERTO RICO, Abarca Warehouse, Inc., P.O. Box 2352.  
 SAN LUIS POTOSI, S.L.P., MEXICO, Talleres Perez Zozaya, J. de los Reyes 80.  
 SAN SALVADOR, EL SALVADOR, Vairo Hermanos, Colonia Vairo.  
 SANTIAGO, CHILE, Lowenstein & Stewart, S.A.C., P.O. Box 2195, Calle Santo Domingo 1140.  
 SAO PAULO, BRAZIL, Casa de Maquinas Falk, Ltda., Av. Duque de Caxias 610. Bag Closing & Bag Making Machines.  
 SAO PAULO, BRAZIL, Maquinas de Costura Panambra, S.A., Rua Brigadiero Tobias 388. Textile Machines

## • Near East

BAGHDAD, IRAQ, Sons of O. O. Agopian, P.O. Box 121.  
 BEIRUT, LEBANON, Sons of O. O. Agopian, P.O. Box 1165.  
 CAIRO, EGYPT, Mr. A. Kavaldjian, 4, Midan El-Hami, Kasr el Nil Bridge.  
 DAMAS, SYRIA, Elias Aractingi & Fils, Sidi Amoud.  
 ISTANBUL, TURKEY, David ve Varber ve Seriki, Hamdi Bey Gecidi 36, 38, 40, Posta Kutusu 385.  
 TEL AVIV, ISRAEL, L. Taube, Ltd., 15 Lilienblum St.

## • New Zealand

Sole Distributors—H. A. Tuck & Co., Ltd.  
 AUCKLAND, 171 Albert St., C. I. (Head Office)  
 WELLINGTON, Ford Bldg., Courtenoy Place.  
 CHRISTCHURCH, (Sub-Agents) Glendernid, Ltd 78 Lichfield St.  
 DUNEDIN, (Sub-Agents) Glendernid, Ltd., 18 Dowling St.

## • Pacific Islands

CEBU, THE PHILIPPINES, Atkins, Kroll and Co., Inc., Textile Machines.  
 HONOLULU, HAWAII, Commercial Sewing Machine Service, Ltd., 732 Haniwai St. Textile Machines.  
 HONOLULU, HAWAII, H. S. Gray Company, P.O. Box 3016, 759 Puulaa Rd. Bag Closing Machines.  
 MANILA, PHILIPPINE ISLANDS, Atkins, Kroll & Co., Inc., 124 Myers Bldg., Port Area. Textile Machines.  
 MANILA, PHILIPPINE ISLANDS, Earnshaws Docks & Honolulu Iron Works Co., Corner of Tacoma and 2nd Sts., Port Area. Bag Closing Machines.

## • United States

ALLENTOWN, PA., 1512 Catalina Ave., Box 542, L. D. Cassell. Tel. Hemlock 4-3900.  
 ★ATLANTA, GA., 81 Peachtree Pl., N.W., M. O. Moulton, Mgr. Tel. Atwood 2733, 2734.  
 BALTIMORE 15, MD., P.O. Box 2505 R. B. Foster. Tel. Sar. 7-8499.  
 BELLEVILLE, N. J., 18 Preston St., D. C. Jenkins. Tel. Plymouth 1-0304.  
 ★BOSTON 11, MASS., 179 Lincoln St., Wm. E. Palm, Mgr. Tel. Liberty 2-0147-48.  
 ★CHICAGO 10, ILL., 404 N. Franklin St., O. A. Ullrick, Mgr., Tel. Superior 7-6920.  
 ★CINCINNATI 25, O., 3372 Central Pkwy. A. E. Brauch, Mgr. Tel. Kirby 5558.

CLEVELAND 11, OHIO, 11902 Milligan Ave., David G. Lee. Tel. Clearwater 1-3462.  
 COLUMBIA, S. C., 319 Howard St., C. A. Page, Tel. 6-8806.  
 COMMERCE, GA., State St. J. T. Hanley. Tel. 3-6872.  
 CONYNGHAM, PA., Box 46, Robert S. Vogt. Tel. Sunset 8-5556.  
 DALLAS 2, TEXAS, P.O. Box 5013. Emmett Richards. Randolph 5722.  
 DENVER 10, COLO., 1801 South Marion St. L. E. Carter, Tel. Spruce 7-7060.  
 DETROIT 21, MICH., 16630 Ward Ave. John F. Lux, Tel. University 3-4948.  
 GREENSBORO, N. C., P.O. Box 226. W. D. Harrad. Phone: 3-7648.  
 GREENVILLE, S. C., 119 Phillips Lane, M. M. Ambrose, Tel. 3-4647.  
 INDIANAPOLIS 1, IND., 3731 N. Tacoma Ave. B. L. Rogers. Tel. Liberty 6-2277.  
 JACKSON, MISS., 327 Eastview St. J. A. Boyette. Tel. 5-1976.  
 JOHNSON CITY, N. Y., 471 Main St., J. J. Laffer, Tel. 7-3994.  
 KANSAS CITY 41, MO., P.O. Box 824, T. O. Biggers, Tel. South 5030.  
 LATHAM (TROY), NEW YORK, 19 Aragon Ave., J. R. LeTourneur, Tel. State 5-6663.  
 LYNCHBURG, VA., P.O. Box 1075. C. D. Mairs. Tel. 3-1215.  
 ★LOS ANGELES 15, CAL., 119 E. Pico Blvd. P. M. Mason, Mgr. Tel. Richmond 7-9187, 7-9188.  
 MEMPHIS, TENN., 4695 Dunn Rd., R. J. Lindhorst, Tel. Mutual 5-6750.  
 MIAMI 37, FLA., 2101 Northwest 1st Ave., H. L. Simon, Tel. 82-0323.  
 MINNEAPOLIS, MINN., 2800 Texas Ave., St. Louis Park, Minn. Leonard Koehler. Tel. Midway 6236.  
 NASHVILLE 12, TENN., 1602 South Observatory Drive. W. J. Brauch. Tel. Cypress 2-5123.  
 NEW ORLEANS, LA., 59 W. Claiborne Square, Chalmette, La., L. A. Van Hooser. Tel. Edgewood 1-3106.  
 ★NEW YORK 16, N.Y., 116 E. 27th St. W. G. Booth, Mgr. Tel. Murray Hill 9-1266, 9-1267, 9-1268.  
 ★PHILADELPHIA 7, PA., 1316 Arch St. B. W. Merz, Mgr. Tel. Locust 7-1023.  
 PITTSBURGH 26, PA., 521 Brookline Blvd., Richard Marsh, Tel. Locust 3-3589.  
 PLANT CITY, FLA., 214 N. Gordon St. J. C. Morgan. Tel. 3-2681.  
 PORTLAND 7, ORE., P.O. Box 843, Marvin H. Corns. Capital 3-7500.  
 RAYNHAM, MASS., P.O. Box 141. W. P. Godek. Tel. Tauton 2-5149.  
 RUTHERFORD, N. J., 246 Sylvan St., Richard Whitson. Tel. Geneva 8-2178.  
 ★ST. LOUIS, MO., 1517-21 Olive St., Z. X. Bennett, Mgr. Tel. Chestnut 1-2368.  
 SALT LAKE CITY, UTAH, 1215 E. 13th South St. L. F. Rosvall.  
 SAN ANTONIO, TEXAS, P.O. Box 201, H. E. Pearson. Tel. Pershing 2-2884.  
 SAN FRANCISCO 7, CALIF., 1275 Mission St. R. J. Vail. Tel. Underhill 1-1580.  
 SEATTLE, WASH., 808 Motor Pl. Paul Lockett. Tel. Seneca 8083.  
 TUPELO, MISS., 831 Strauss St., Lloyd Baldwin. Tel. 1859-J.  
 WAKEFIELD, MASS., 195 North Ave., H. Haberman Jr., Tel. Crystal 9-0455.  
 YORK, PA., 444 South George St. Richard L. Smith. Tel. York 8-5592.

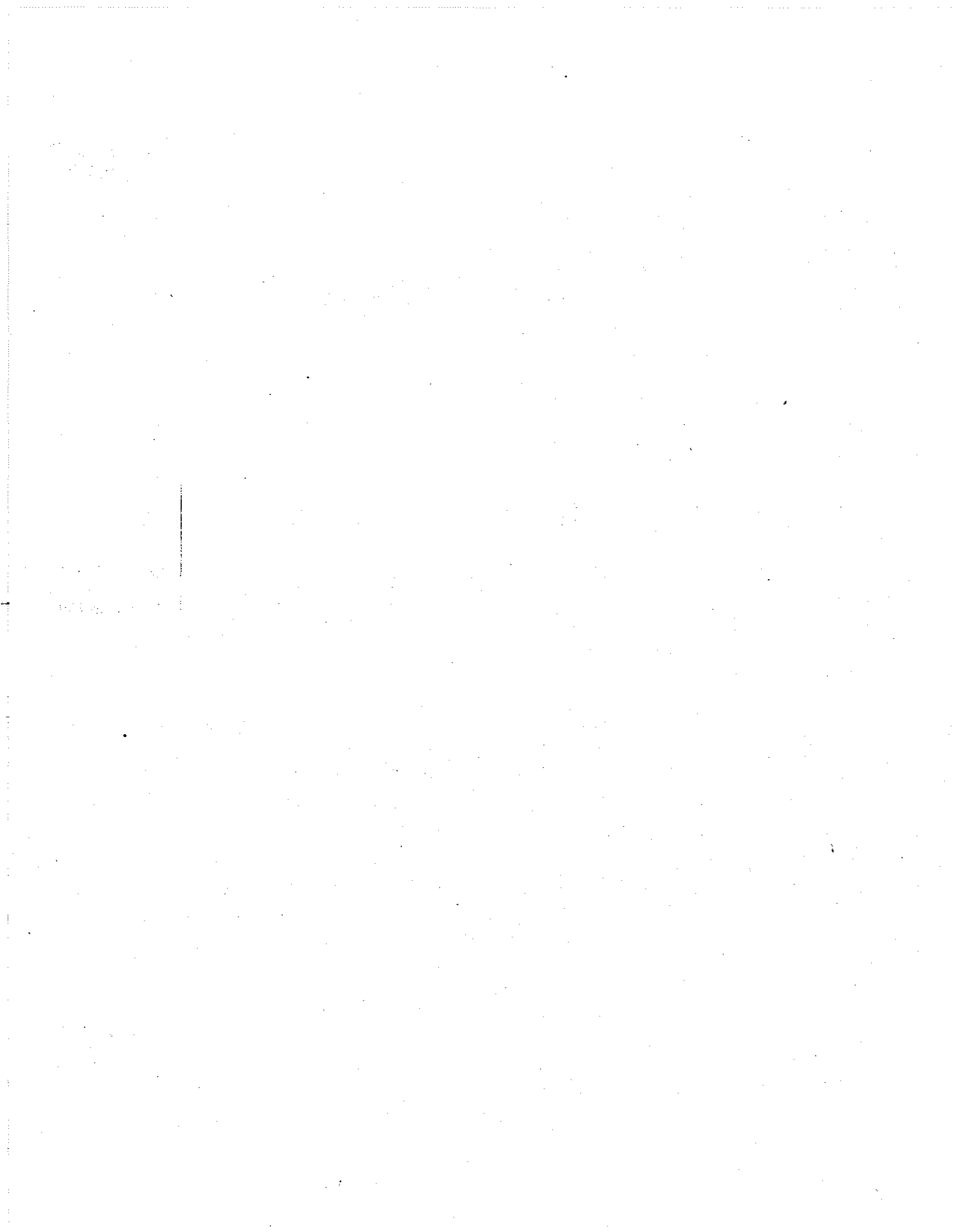

## FOREWORD

The one dominating idea back of "Union Special" is to build the best industrial sewing machines in the world. Our new line of Enclosed Type Flat Bed Machines, known as the "Fifty-Thousand Series" marks an epoch in sewing machine design and construction.

All parts are made to gauges with exceedingly close limits. Oil Cups are provided for all important bearings, and a convenient oil drain catches the surplus. Repairs can be made with facility, as all parts are readily accessible, and are 100% interchangeable.

It is our constant aim to furnish carefully prepared information that will enable the customer to secure all possible economies and advantages from the use of Union Specials. On the pages which follow will be found illustrations and descriptions of the parts for styles in Classes 52700, 52800, 52900, 53500.

Additional catalogs, containing information relative to these machines, and which will be furnished on request, are listed below.

Catalog No. 29	List of Transmitter Parts
Catalog No. 45	List and Description of Needles
Catalog No. 45 A Form 357	Price List of Needles Engineering Department Adjusting Instructions. Specify the Style number of the machine for which the adjusting instructions are required

In all manufacturing centers will be found Union Special representatives, who will co-operate with those who desire in planning and estimating their requirements.

UNION SPECIAL MACHINE COMPANY

Engineering Department

## IDENTIFICATION OF MACHINES

Each Union Special carries a style number which is stamped in the name plate on the machine. Style numbers are classified as standard and special. Those which are standard have one or more letters suffixed, but never contain the letter "Z". Example: 52700 A. Style numbers which contain the letter "Z" are special. When only minor changes are made in a standard machine a "Z" is merely suffixed to the respective standard style number. Example: 52700 AZ.

Styles of machines similar in construction are grouped under a class number which differs from the style number in that it contains no letters. Example: 52700.

The overall width of the stitch in Classes 52700 and 52800 machines is represented by a gauge number measured in 64ths. of an inch, viz: 16 gauge represents a stitch measuring 1/4 inch wide.

The distance between the needles perpendicular to the line of feed in Class 52900 machines is represented by gauge numbers measured in 64ths. of an inch. The number following the first hyphen (-) represents the distance between the left and middle needle and the number following the second hyphen (-) represents the distance between the middle and right needle, viz: 52900 A-5-8 gauge represents a distance of 5/64 inch between the left and middle needle and 1/8 inch between the middle and right needle.

The distance between the rows of stitches in Class 53500 machines is represented by a gauge number measured in 64ths. of an inch, viz: 16 gauge represents a distance of 1/4 inch.

## APPLICATION OF CATALOG

This catalog applies only to the standard styles of machines as listed herein. It can also be applied with discretion to the special machines in these classes.

### STYLES OF MACHINES IN CLASS 52700

Enclosed Type Flat Bed Two and Three Needle One Looper Machines, External Presser Spring, Shielded Disc Take-up

52700 A (Succeeds 6900 H) For making belt loops for trousers, overalls, bathrobes, and similar garments; stitch Type 406, strips used in short lengths, non-differential feed, needles Type 126, standard gauges Nos. 12 and 16.

52700 B For hemming sides and bottoms of bathrobes made from woven fabrics, with fabric folded next to feed dog; stitch Type 406, adjustable folder which turns in from 1/2 to 1 inch of fabric, non-differential feed, needles Type 126, standard gauges Nos. 12 and 16.



STYLES OF MACHINES IN CLASS 52700- (Cont'd)

- 52700 F For attaching elastic in long lengths to full fashioned hosiery; three needle stitch Type 407, wrench adjustment tandem differential feed, needles Type 121, standard gauge No. 12.
- 52700 G For attaching elastic bands 7/8" to 2" wide, in long lengths, garment lengths, or with ends joined, to flat knit, warp knit and rib knit light weight garments made from rayon, silk, cotton, and wool; three needle stitch Type 407, non-differential feed, needles Type 121, standard gauge No. 16.
- 52700 H For attaching elastic bands 3/8" to 1 1/4" wide, in long lengths, garment lengths, or with ends joined, to flat knit, warp knit and rib knit light weight garments made from rayon, silk, cotton, and wool; twin needle stitch Type 406, non-differential feed, needles Type 121, standard gauges Nos. 8, 12 and 16.
- 52700 Z A special style, similar to the standard styles in Class 52700, but differing in some of its component parts.

STYLES OF MACHINES IN CLASS 52800

- Enclosed Type Flat Bed Four and Five Thread Interlock Machines, Stitch Types 602 and 605, Lateral Looper Travel, External Presser Spring, Shielded Disc Take-up
- 52800 B (Succeeds 5100 H) For attaching cuffs to knitted undergarments; one operation lap seam, Five Thread Interlock Stitch Type 605, three needles, wrench adjustment off-set differential feed, needles Type 121, standard gauge No. 16.
- 52800 D (Succeeds 5100 G) For seaming medium and heavy weight undergarments; one operation lap seam, Five Thread Interlock Stitch Type 605, three needles, three-section bottom presser foot, wrench adjustment tandem differential feed, needles Type 121, standard gauge No. 16.
- 52800 E (Succeeds 13100 F) For attaching split tube border to neck and armholes of athletic shirts made from light weight knitted cotton and rayon fabrics; Four Thread Interlock Stitch Type 602, two needles, long length light weight flat knit strip, cut parallel with wale, wrench adjustment off-set differential feed, folder has 3/64 inch capacity, needles Type 121, standard gauge No. 8, standard finished widths 7/16, 1/2, 5/8, and 3/4 inch.

STYLES OF MACHINES IN CLASS 52800 (Cont'd)

- 52800 F (Succeeds 13100 C) For attaching split tube border to union suits, vests, step-ins, chemises, and similar garments made from light weight knitted cotton and rayon fabrics; Four Thread Interlock Stitch Type 602, two needles, long length light weight flat knit strip cut parallel with wale, wrench adjustment off-set differential feed, folder has  $\frac{3}{64}$  inch capacity, needles Type 121, standard gauge No. 8, standard finished widths  $\frac{1}{2}$ ,  $\frac{5}{8}$ ,  $\frac{3}{4}$ ,  $\frac{7}{8}$ , and 1 inch.
- 52800 G (Succeeds 13100 B) For attaching knitted tubing and previously made lace to knitted undergarments; lap seam, Four Thread Interlock Stitch Type 602, two needles, wrench adjustment tandem differential feed, needles Type 121, standard gauge No. 8.
- 52800 H (Succeeds 5000 L) For attaching collarettes to knitted undergarments; Four Thread Interlock Stitch Type 602, two needles, long length rib knit strip cut perpendicular to the wale or parallel with the wale, wrench adjustment off-set differential feed, folder has  $\frac{1}{16}$  inch capacity, needles Type 121, standard gauge No. 12, standard finished widths  $\frac{3}{4}$ ,  $\frac{7}{8}$ , 1, and  $1\frac{1}{4}$  inches.
- 52800 J (Succeeds 5000 C) For the second part of the two operation process of attaching garment length collarettes to knitted undergarments; Four Thread Interlock Stitch Type 602, two needles, wrench adjustment tandem differential feed, needles Type 121, standard gauge No. 12.
- 52800 K For attaching collarettes to knitted undergarments; Five Thread Interlock Stitch Type 605, three needles, long length rib knit strip cut perpendicular to the wale or parallel with the wale, wrench adjustment off-set differential feed, folder has  $\frac{1}{16}$  inch capacity, needles Type 121, standard gauges Nos. 14 and 16, standard finished widths  $\frac{3}{4}$ ,  $\frac{7}{8}$ , 1, and  $1\frac{1}{4}$  inches.
- 52800 Z A special style, similar to the standard styles in Class 52800, but differing in some of its component parts.

## STYLES OF MACHINES IN CLASS 52900

Enclosed Type Flat Bed Three Needle Machines, Two Loopers, Left Needle in Rear, Dual Stitch, Double Locked Type 401 on Left and Four Thread Interlock Type 602 on Right, Vertical Trimming Mechanism, External Presser Spring, Shielded Disc Take-up

52900 A For simultaneous seaming and overedging of garment pockets, and similar articles, with the exclusive Union Special "Safety Stitch", needles Type 126, standard gauge No. 5-8.

52900 B For simultaneous seaming and overedging of street and house dresses, coat linings, pillow cases, and similar articles, with the exclusive Union Special "Safety Stitch", needles Type 126, standard gauges Nos. 5-8, 16-8.

52900 Z A special style, similar to the standard styles in Class 52900, but differing in some of its component parts.

## STYLES OF MACHINES IN CLASS 53500

Enclosed Type Flat Bed Machines, Two Motion Ruffling Mechanism, Double Locked Stitch Type 401, Lateral Looper Travel, External Presser Spring, Single Disc Take-up

53500 C (Succeeds 9800 S) For attaching ruffles to lace curtains and similar articles; two needles set abreast, diagonal looper travel, continuous ruffling mechanism with knee press control for increasing fullness at corners, needles Type 106, standard gauge No. 16.

53500 D Without knee press control for increasing fullness at corners; otherwise same as 53500 C, standard gauge No. 16.

53500 Z A special style, similar to the standard styles in Class 53500, but differing in some of its component parts.

## NEEDLES

### TYPE NUMBERS AND SIZES

Each needle has a type number and size number. The former denotes the kind of shank, point, length, groove, finish, and other details. The latter denotes the largest diameter of the blade, measured in thousandths of an inch midway between the shank and eye, and is stamped in the needle shank. Collectively, the type number and size number is the complete symbol.

To have orders promptly and accurately filled, the empty package, a sample needle, or the type and size numbers should be given. See marks on packages. An intelligent order would read as follows "1000 Needles Type 121 Size 032".

## NEEDLES

### TYPE NUMBERS AND SIZES (Cont'd)

The type numbers of the needles most commonly used in the styles of machines covered by this catalog are listed below. Set opposite each type number is the description of the needle and the sizes available.

Type No.	Description
101	Round shank, round point, extra short, double groove, nickel plated- sizes 019, 022, 025, 027, 029, 032, 034, 036, 038, 040, 042, 044, 046, 049, 054.
101 G	Same as Type 101, except finish is chromium plated- sizes 032, 036, 040.
106	Round shank, round point, extra short, double groove, ball eye, standard length blade, nickel plated- sizes 027, 029, 032, 036, 038, 040, 042, 044, 049.
106 A	Same as Type 106, except blades are 1/16 inch shorter and shanks are 1/16 inch longer- sizes 032, 036.
106 G	Same as Type 106, except finish is chromium plated- sizes 032, 036, 040, 044.
121	Round shank, round point, short, double groove, nickel plated- sizes 019, 022, 025, 027, 029, 032, 036, 038, 040, 042, 044, 049, 054.
121 G	Same as Type 121, except finish is chromium plated- sizes 032, 036, 040, 049.
124	Round shank, round point, short, double groove, spotted, nickel plated- sizes 040, 044, 049.
126	Round shank, round point, short, double groove, ball eye, nickel plated- sizes 027, 032, 036, 040, 042, 044, 049, 054.
128	Round shank, round point, short, double groove, ball eye, spotted, nickel plated, standard length blade, standard width of eye and grooves- sizes 032, 036, 040, 044, 049, 054.
128 F	Same as Type 128, except the width of the eye and grooves are under-size one step reduction- sizes 044, 049, 054.
128 G	Same as Type 128, except the width of the eye and grooves are under-size one step reduction, and finish is chromium plated- sizes 044, 049, 054.

NEEDLES (Cont'd)

Type No.

- 128 GA Same as Type 128, except finish is chromium plated-  
sizes 040, 044, 049, 054.
- 929 Round shank, spear point, short, double groove,  
ball eye, spotted, nickel plated, standard length  
blade, standard width of eye and grooves- sizes  
044, 049, 054.

APPLICATION OF TYPE NUMBERS TO MACHINES

The standard type of needle applicable to each style is listed in the description of each style. The styles of machines covered by this catalog are listed below. Set opposite each style number is the type numbers of the needles that can be used. Type numbers are arranged numerically, as the variety of the materials sewed on each machine makes it impractical to show a preference.

Machine Style	Type of Needles
52700 A	121, 121 G, 124, 126, 128, 128 F, 128 G, 128 GA, 929.
52700 B	121, 121 G, 124, 126, 128, 128 F, 128 G, 128 GA.
52700 F	121, 121 G.
52700 G	121, 121 G.
52700 H	121, 121 G.
52800 B	121, 121 G.
52800 D	121, 121 G.
52800 E	121, 121 G.
52800 F	121, 121 G.
52800 G	121, 121 G.
52800 H	121, 121 G.
52800 J	121, 121 G.
52800 K	121, 121 G.
52900 A	126, 128, 128 F, 128 G, 128 GA, 929.
52900 B	121, 121 G, 126, 128, 128 GA, 929.

## NEEDLES (Cont'd)

### APPLICATION OF TYPE NUMBERS TO MACHINES (Cont'd)

Machine Style	Type of Needles
53500 C	101, 101 G, 106, 106 A, 106 G.
53500 D	101, 101 G, 106, 106 A, 106 G.

### ORDERING REPAIR PARTS

#### PLATES

Grouped, according to scale, will be found illustrations of parts similar in appearance, and, to some extent, component parts that go in the same subdivision of the mechanism.

When a given design of part is made in two or more sizes, only one illustration is usually shown. In ordering these pieces it is necessary that the additional information be furnished as requested under these illustrations.

#### LIST OF PARTS

Turning from the plates to the list of parts, the description of each part and its principal uses will be found. Always check the symbol against its description before ordering. It is not necessary to furnish the plate number.

When a part is used, or can be used, in all machines covered by this catalog, no specific use is mentioned in the description.

For convenience in ordering, minor parts such as screws, nuts and similar articles are repeated after each major part.

(-) A dash in the "plate number" column of the list of parts indicates the absence of an illustration.

(‡) A double dagger in the "symbol to order by" column indicates that the component parts cannot be furnished separately. Due to the high speed of these machines it is impossible for these associated parts to be fitted a second time and make a serviceable job.

#### IDENTIFYING PARTS

Where the construction permits, each part is stamped with its part number. Some of the smaller parts are stamped with an identification letter to distinguish them from parts similar in appearance.

All part numbers represent the same part, regardless of the catalog in which they appear.

#### SUPPLIES

All supplies, including taps, reamers, belting, belt hooks, belt fasteners, screw drivers, wrenches and powdered oil stone will be promptly furnished.

## ORDERING REPAIR PARTS (Cont'd)

### USE GENUINE NEEDLES AND REPAIR PARTS

Success in the operation of these machines can be secured only by the use of genuine Union Special Needles and Repair Parts as furnished by the Union Special Machine Company, its subsidiaries and authorized distributors. Obviously, it is to our interest to maintain the reputation of Union Specials by furnishing the very best goods obtainable. They are designed according to the most approved scientific principles, and are made with the utmost precision. The maximum efficiency and durability are assured.

Genuine needles are put up in packages marked at the top "Trade 'UNION SPECIAL' mark". Genuine repair parts are stamped with a reproduction of the well known two padlocks with a link connecting the shackles. Both trade marks are symbolic of superlative excellence. All other needles and parts are bogus.

### TERMS

Prices are strictly "net cash" and subject to change without notice. All shipments are forwarded at the buyer's risk, f.o.b. shipping point. Parcel post shipments are insured, unless otherwise directed. A charge is made to cover the postage and insurance.

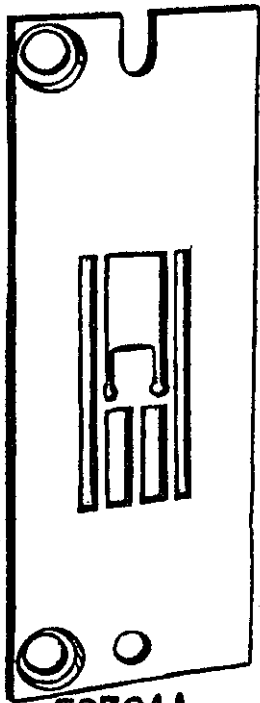

52724A  
Specify  
Gauge

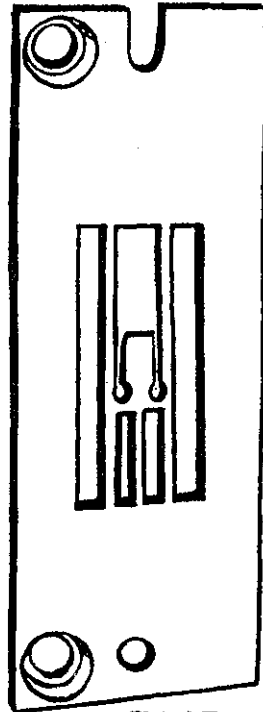

52724B  
Specify  
Gauge

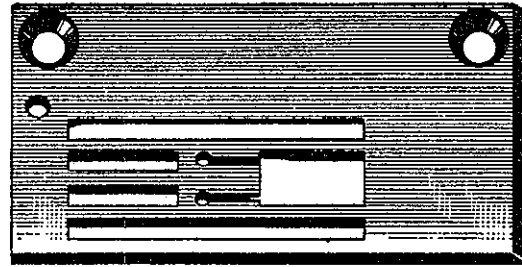

5024B  
Specify  
Gauge

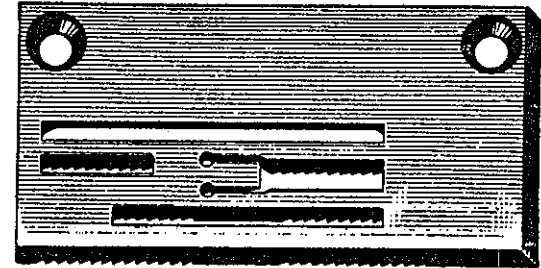

5024M  
Specify  
Gauge

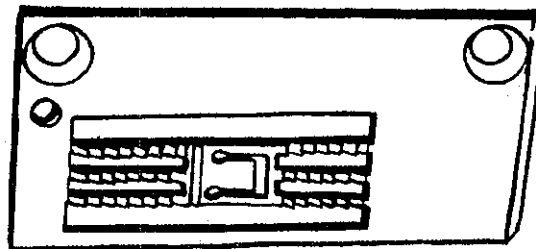

52724H  
Specify  
Gauge

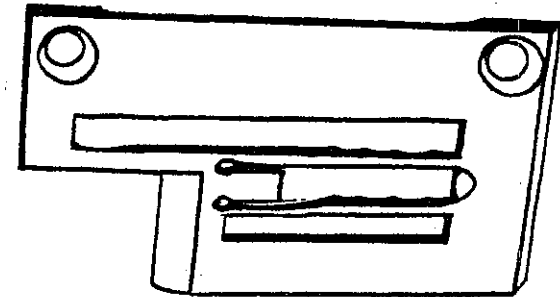

52824F  
Specify  
Gauge

Plate 1 - Full Size



Plate 2 - Full Size

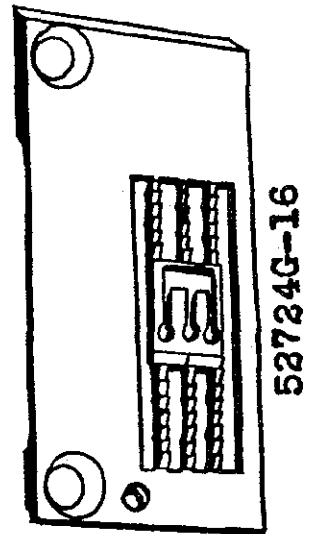
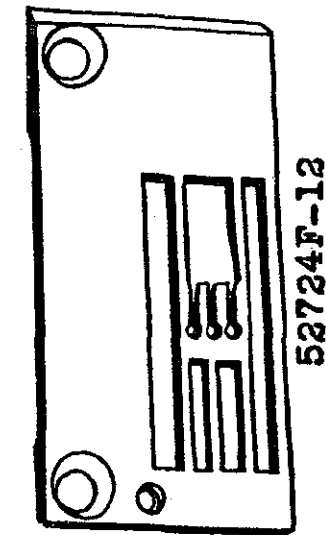
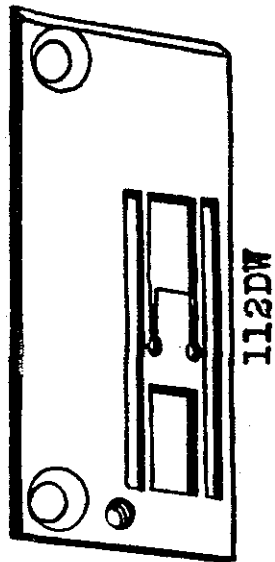
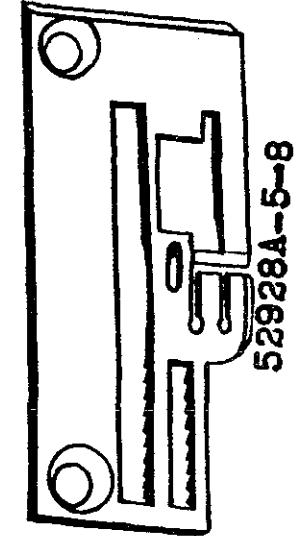
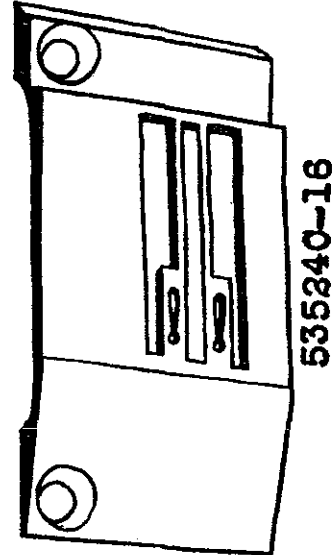
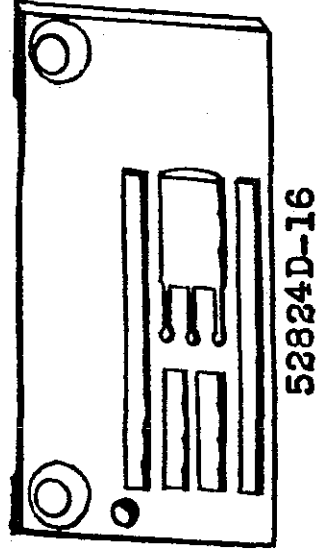
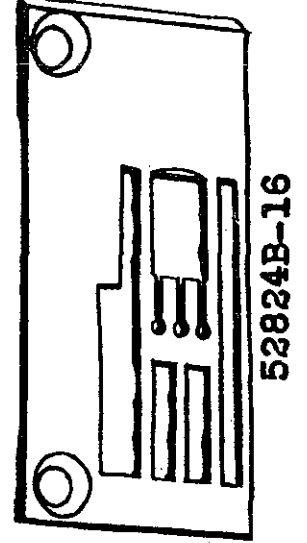
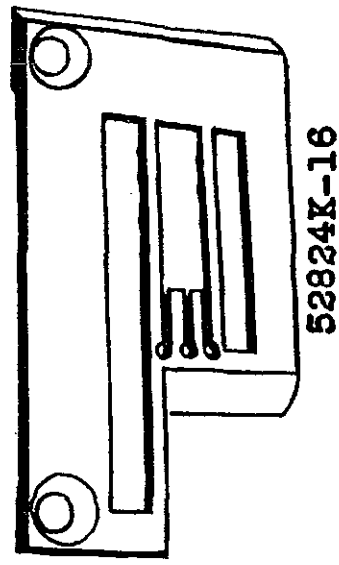
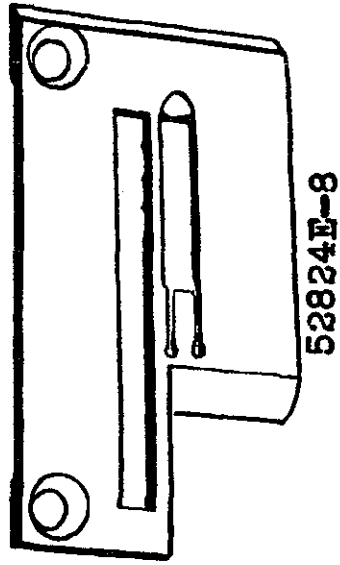
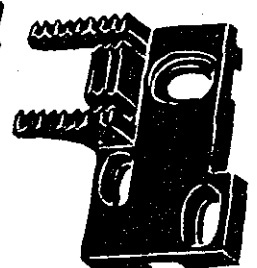
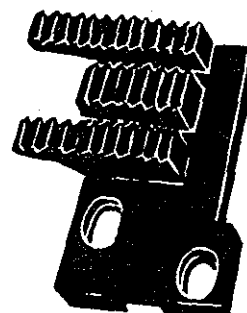
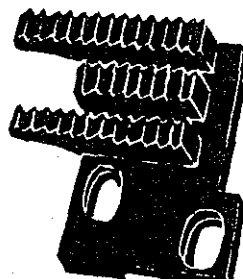
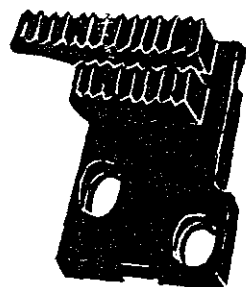
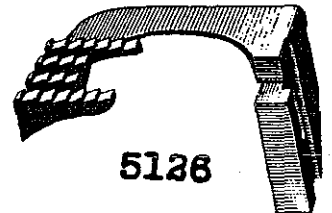
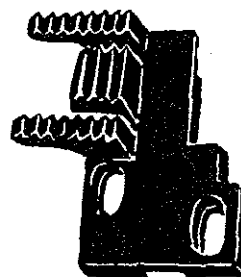
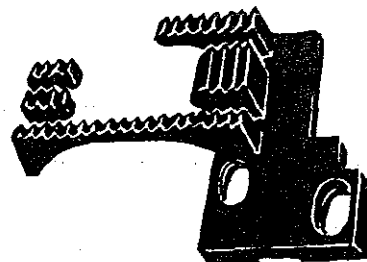
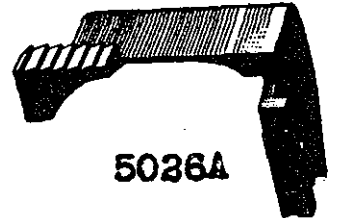
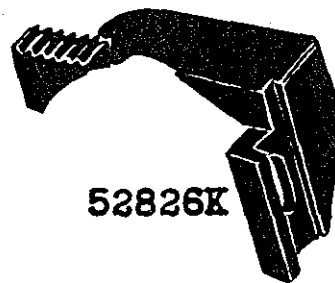
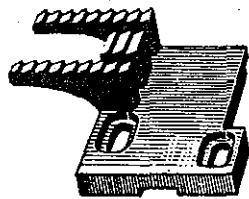
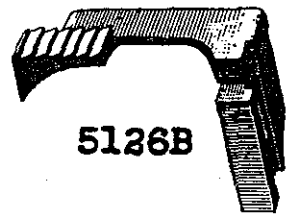
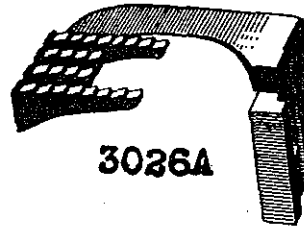
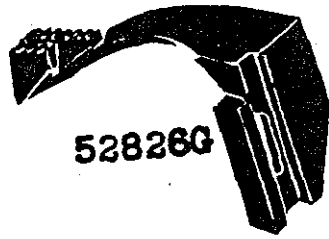
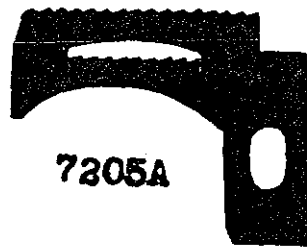
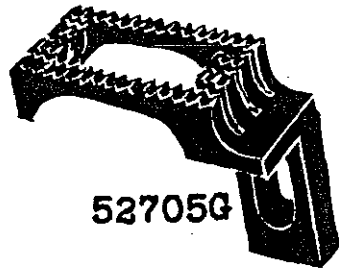

Plate 3 - Full Size



52805E-8

52805F-8

52805K

G5105B

Plate 4 - Full Size

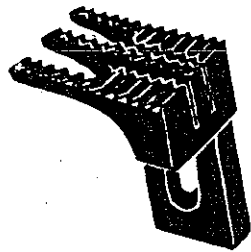

535050-16

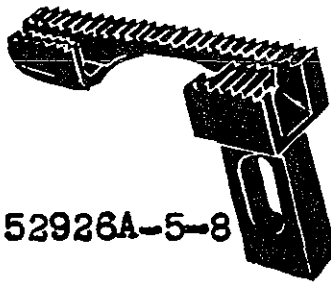

52926A-5-8

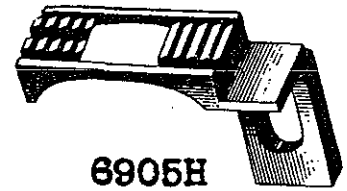

6905H  
Specify  
Gauge

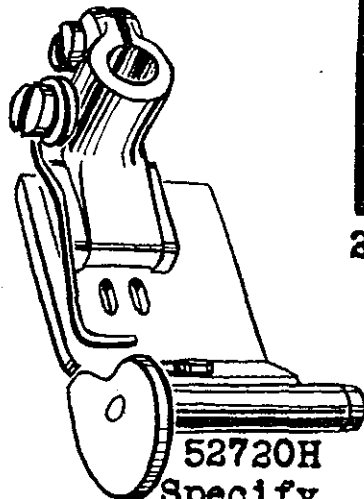

52720H  
Specify  
Gauge

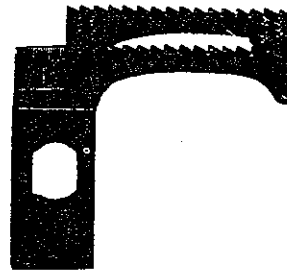

22JW

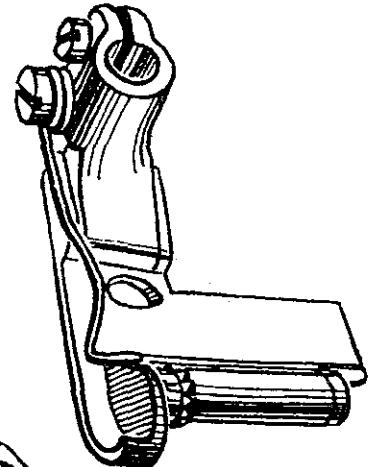

52820G-8

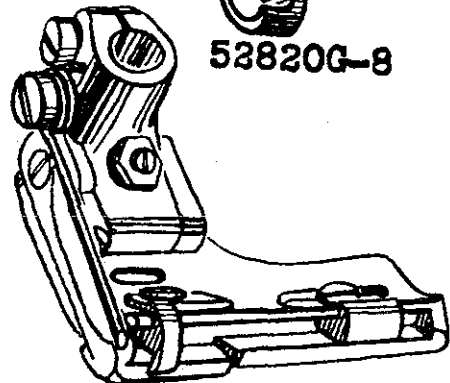

52720F-12

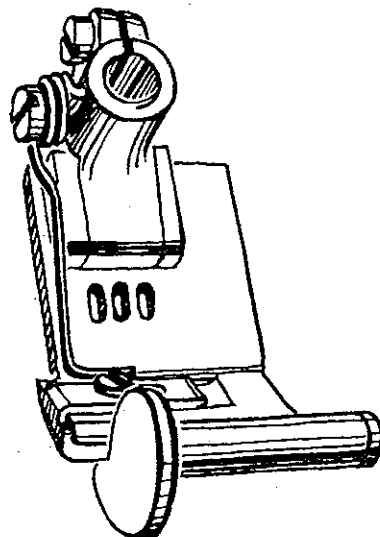

52720G-16

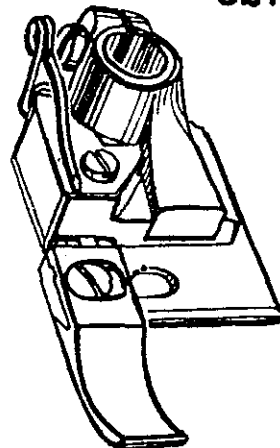

52820H-12

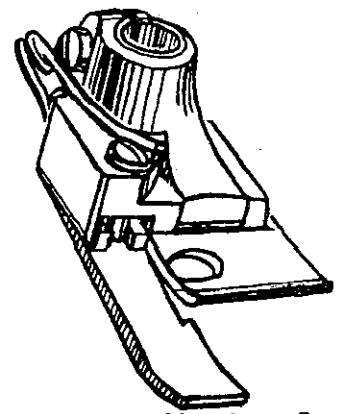

13120F-8

Plate 5 - Full Size

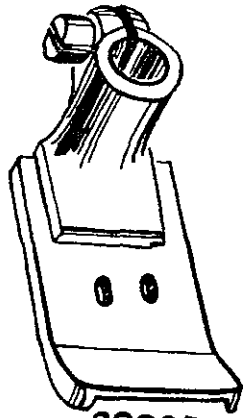

6920L  
Specify  
Gauge

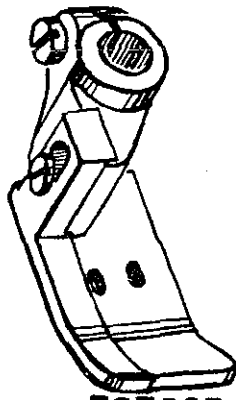

52720B  
Specify  
Gauge

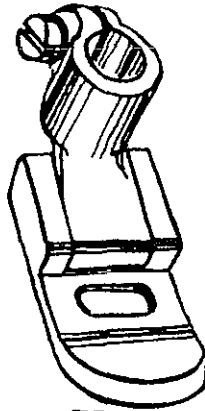

5127J

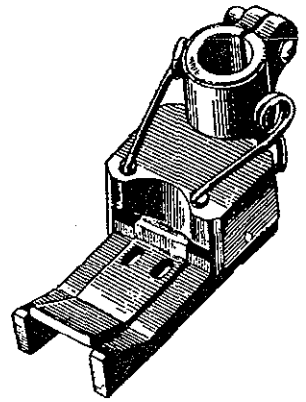

6920A  
Specify  
Gauge



12320E  
Specify  
Gauge

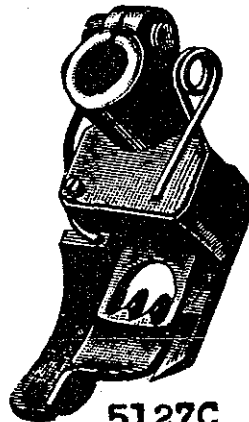

5127C

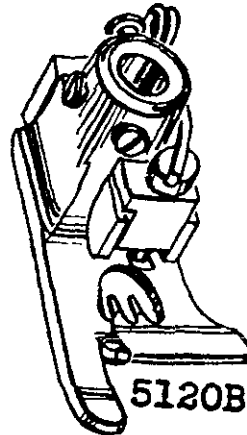

5120B

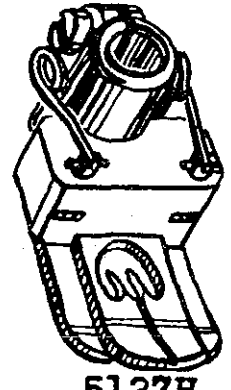

5127H

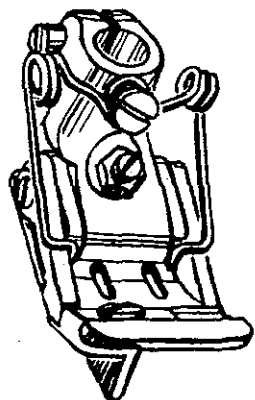

53520C-16

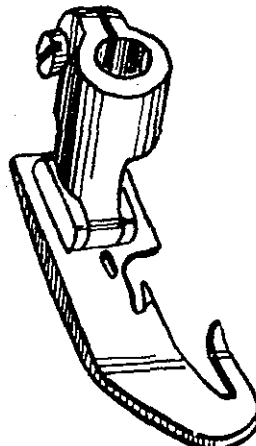

52920A-5-8

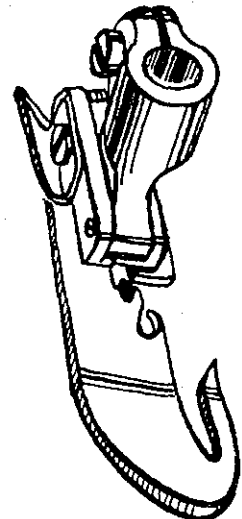

52920B-5-8

Plate 6 - Full Size

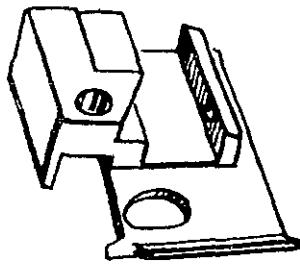

52830H-12

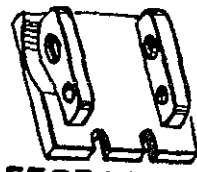

53530A-16

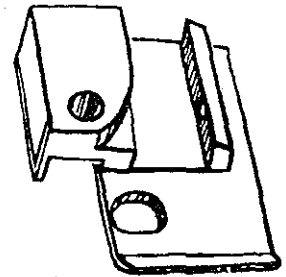

13130F-8

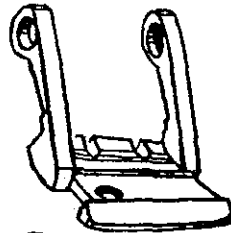

53530B-16

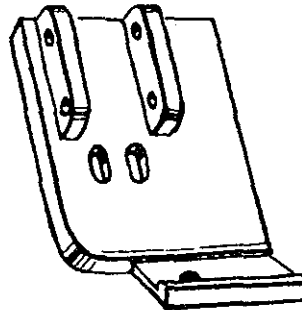

52730H  
Specify  
Gauge

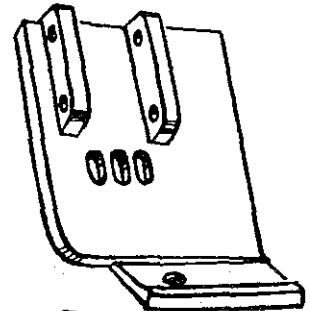

52730G-16

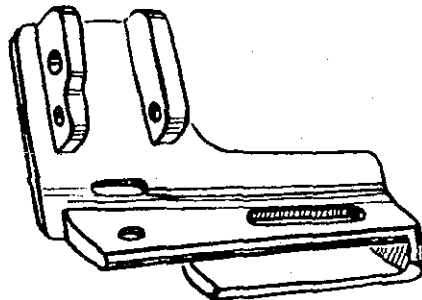

52730F-12

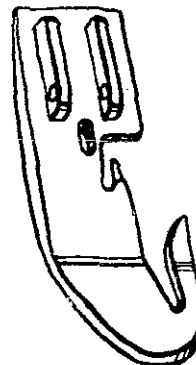

52930A

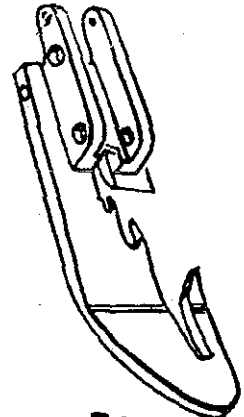

52930B



13130A

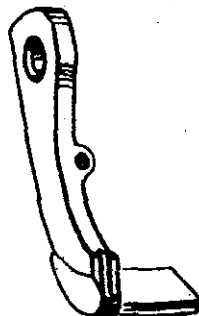

52730J



52830A

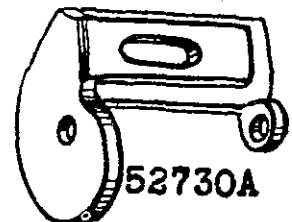

52730A

Plate 7 - Full Size

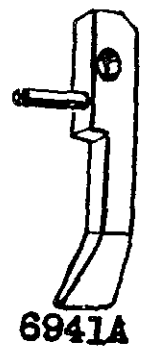
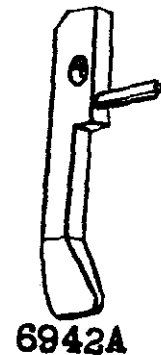
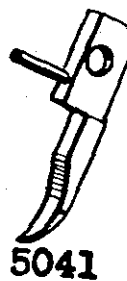
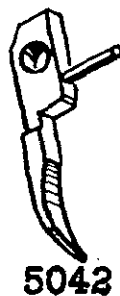
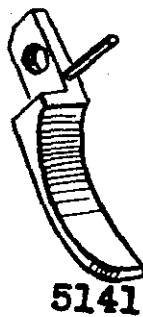
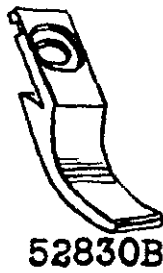
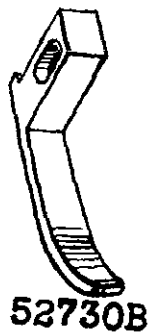
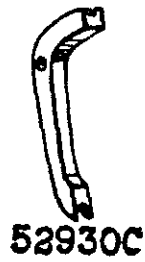
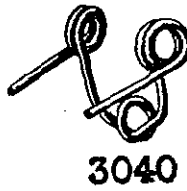
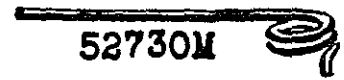
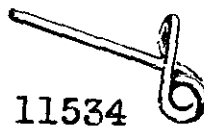
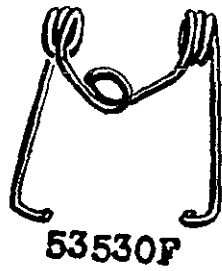

Plate 8 - Full Size

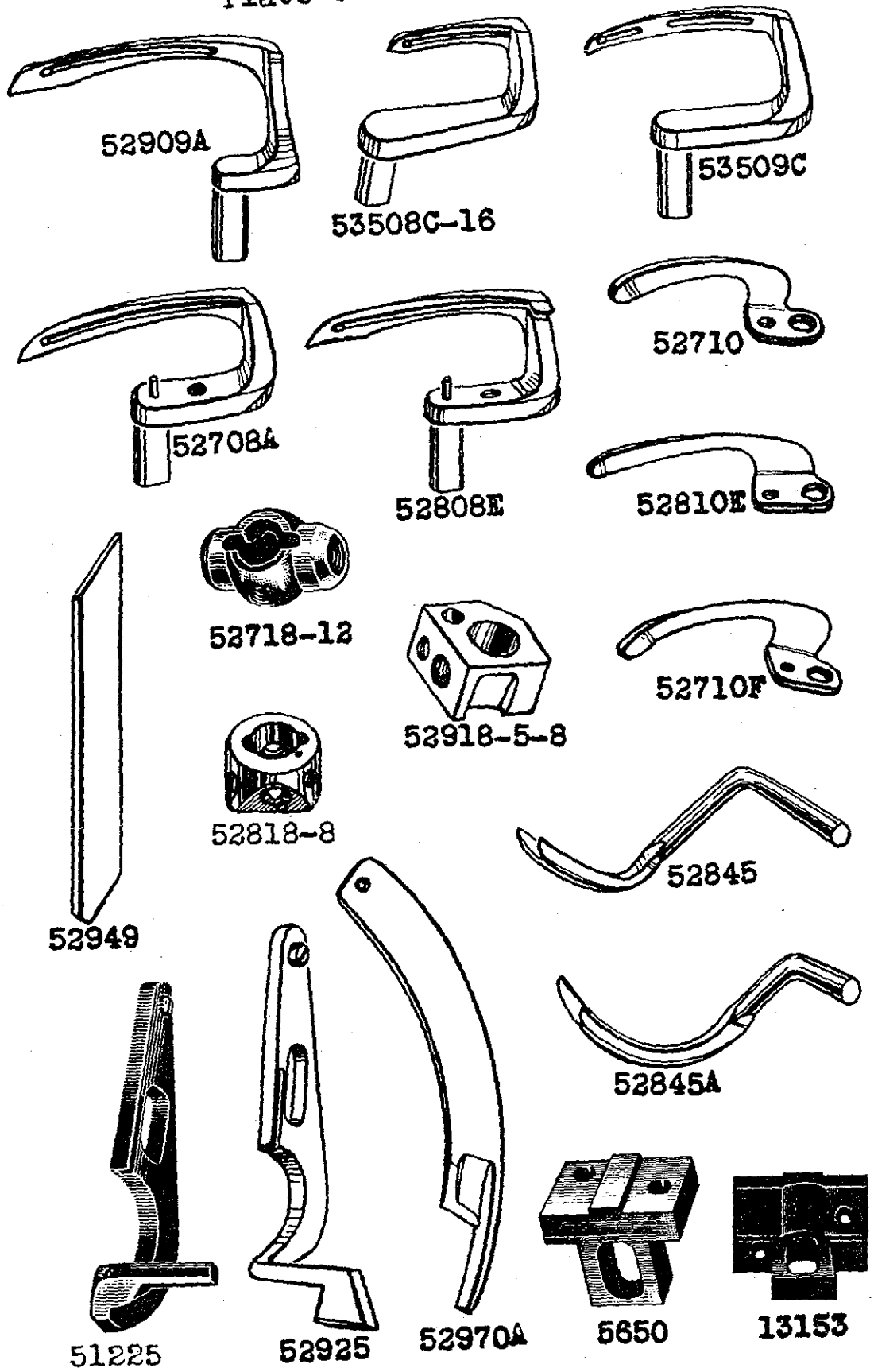

Plate 9 - Full Size













































































 28 B	 HA73B	 28C	 22716A	 22799 N	 25B	 2230
 73 A	 22743	 22738	 22716	 22560	 22561	 89
 78	 21629	 22599	 187 A	 605	 22845B	 604
 28	 22801	 88 B	 22764	 88	 22845A	 87
 87 A	 605 A	 77	 22726A	 357	 22580	 25CC
 98	 22813	 87 U	 187B	 88A	 22570	 73
 96	 22586	 22586 B	 95	 22845E	 22513	 22768
 98 A	 22830	 22760	 90	 22504B	 22560 B	 91
 22562	 22799 F	 538	 22585	 22593	 22764 A	 166
 376	 22525A	 22829	 22519	 22591	 22834	 94
 22711	 22863	 35768 A	 22747	 22632 F-24	 93A	



Plate 10 - Full Size



Plate 11 - Full Size



75



22541



22596



22569



9663

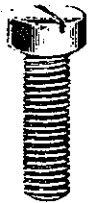

136



75 A

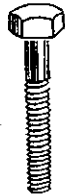

22864



22559 B



22559C



22587

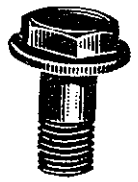

35766

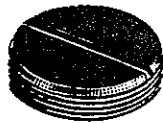

22539C



22509

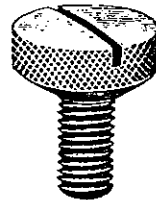

22728



74

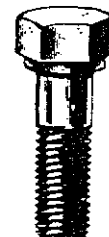

22811



69 FD

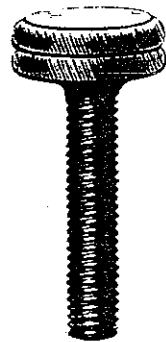

64 A

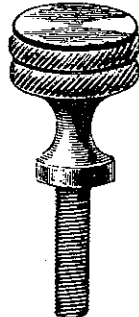

G10

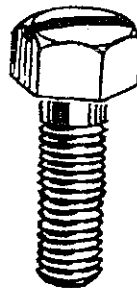

22788

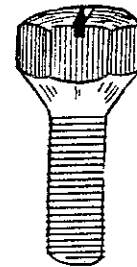

22823A

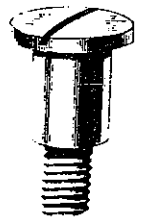

236

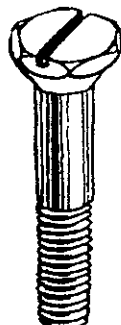

22823B

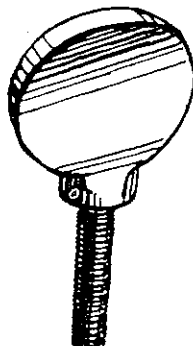

21745D

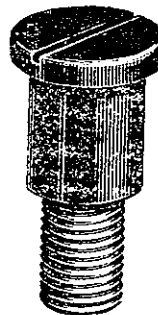

22566A

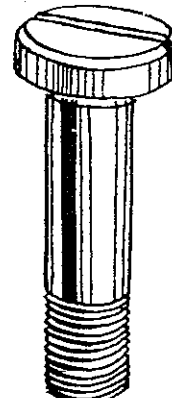

22865

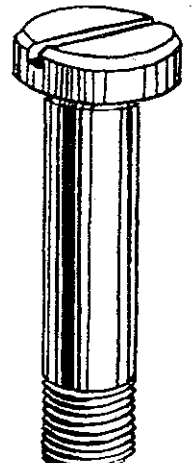

22865A

Plate 12 - Full Size

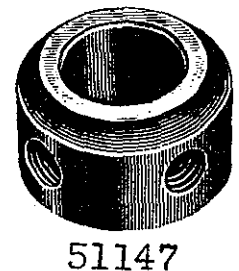
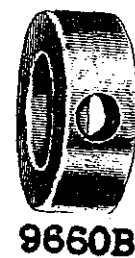
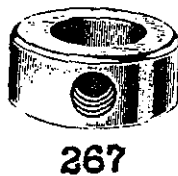
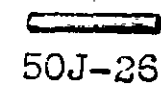
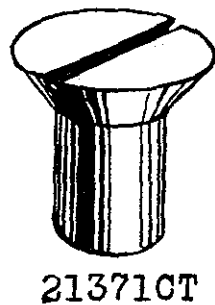
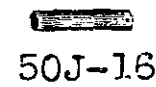
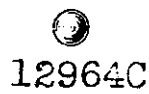
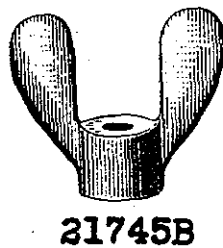
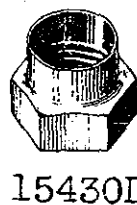
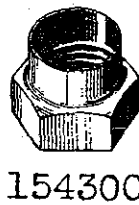
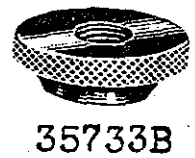
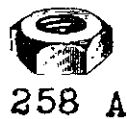

Plate 13 - Full Size

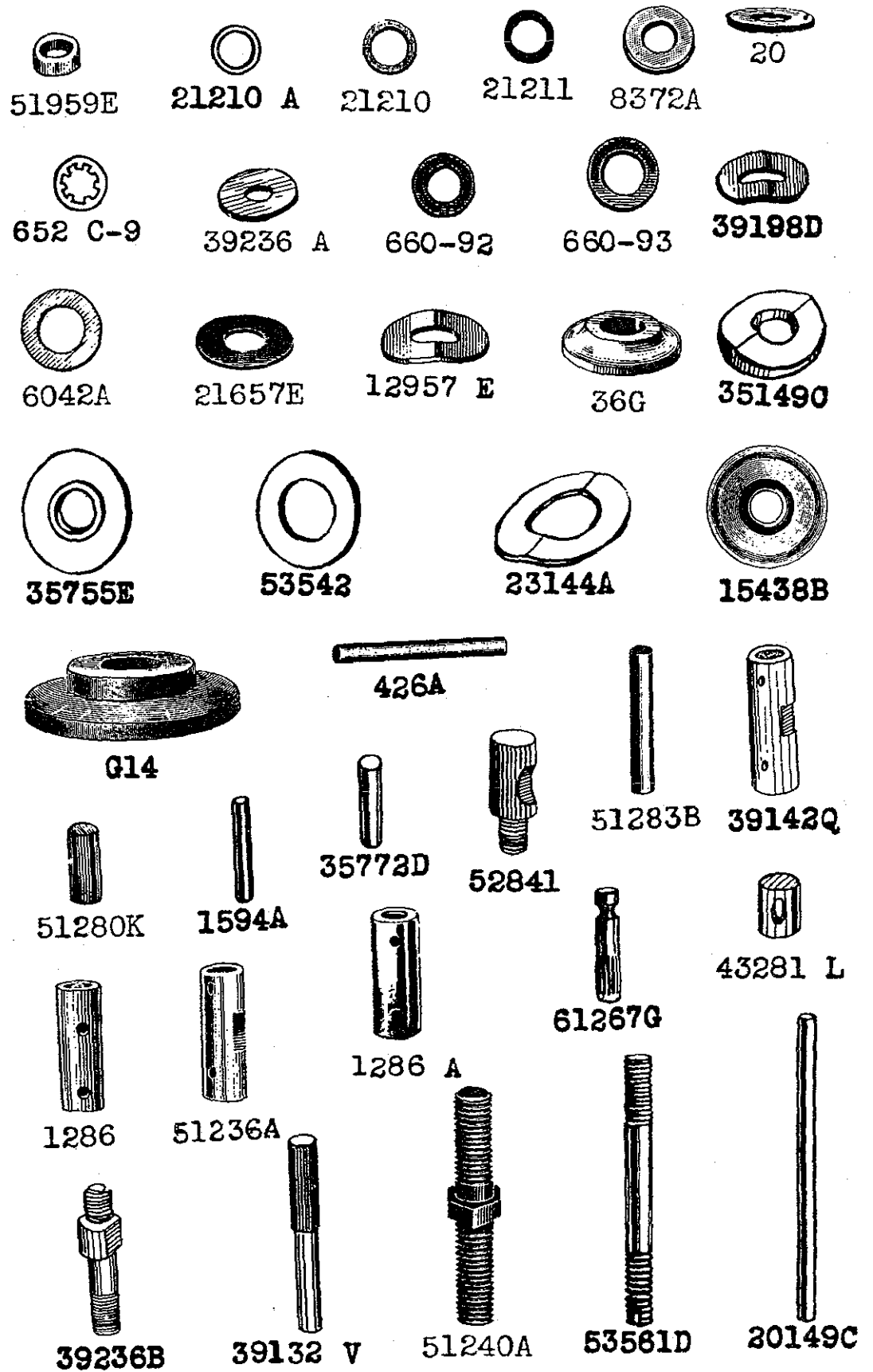
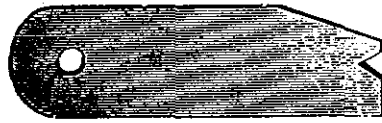

Plate 14 - Full Size



21225  
SPECIFY  
MEASUREMENT



21227V



21227B-8



51283A



21227C  
Specify  
Gauge

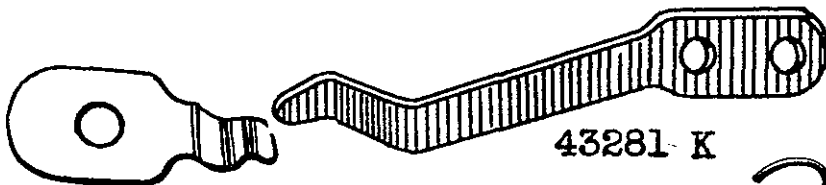

43281-K



15438C



52981G



51292 F-1



52978N



522

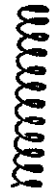

1286B



15872F



51959C



51292 F-4

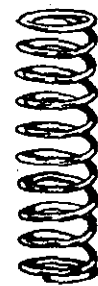

51292 F-5



51292 F-8



51292 F-2



57WC



110-3



1349



51240C



53548C



11663

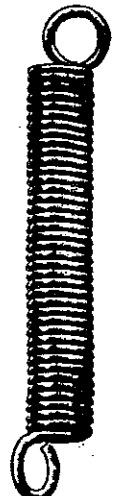

9471

Plate 15 - Full Size

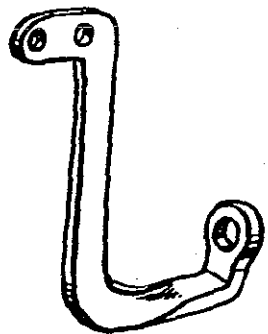

53558



51958B



52958

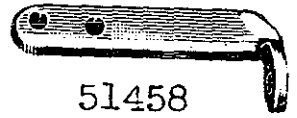

51458



51458A

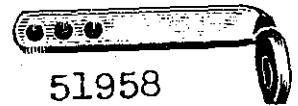

51958



51758



52 A



1288



41076D



51958A

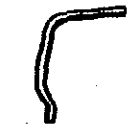

52842G



51158 D

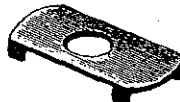

57 WB

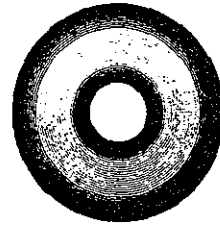

109 B

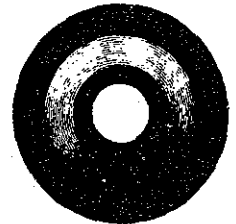

109



158B



158A

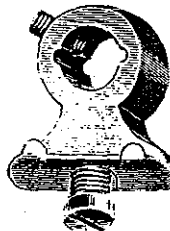

1287



51758A



668-12



668-7

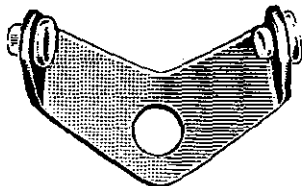

51292 D

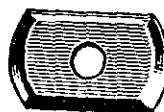

51959B

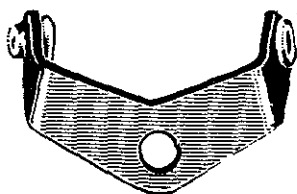

51292 E



35582B



51292



1346



11261A

Plate 16 - Full Size

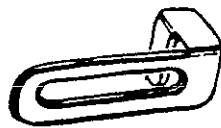

15180B

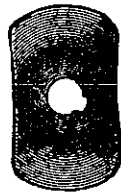

15498H



39237G

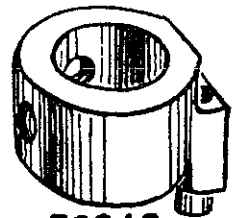

52846



53552N

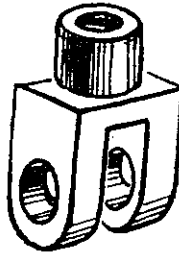

53552P



39236 V

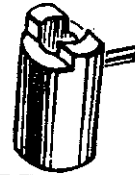

53553R

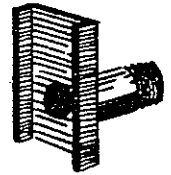

51134 G



53547

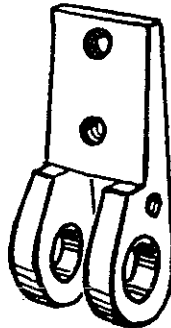

53548



23195



53548G



53548P



53540

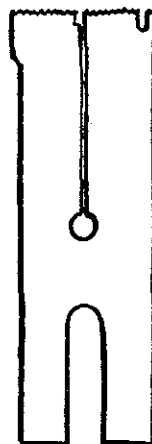

53546-16



53548S

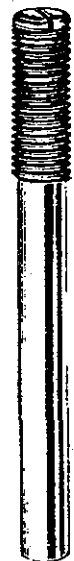

15455

Plate 17 - Full Size

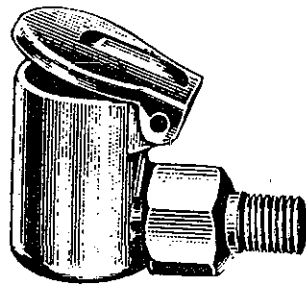

666-28

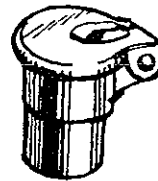

666-50



51243R



660-95



666-49

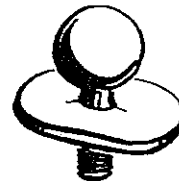

52981P



21351



61294 W



666-11

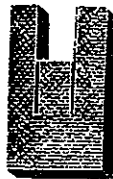

660-90

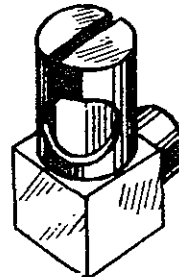

39193



21350



51293B



666-66



660-143



666-19



39193 A



53593B



52894 Z

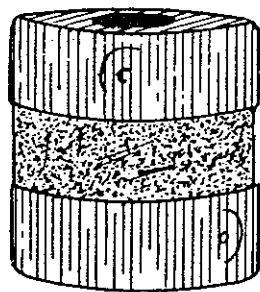

51295



51296



51296 A



666-53



666-13



Plate 18 - Full Size



35731A



51236B



39237D



53560D



52950G



52971H



52972



53541N



51242C

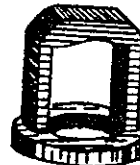

52887 G



51244E

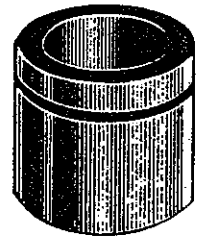

51250B

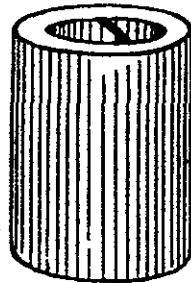

51290 E

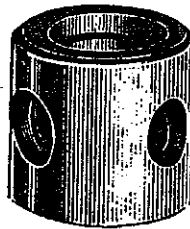

51290D

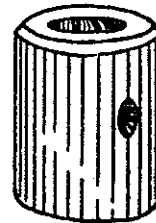

51242 B

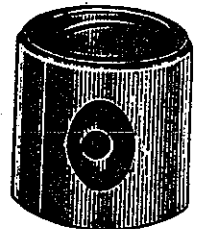

51290



52889

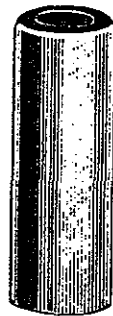

51254A



51254



53556C

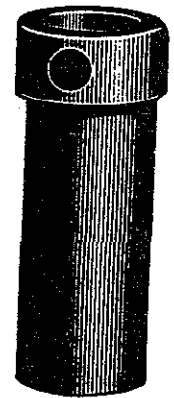

51244C

Plate 19 - Full Size

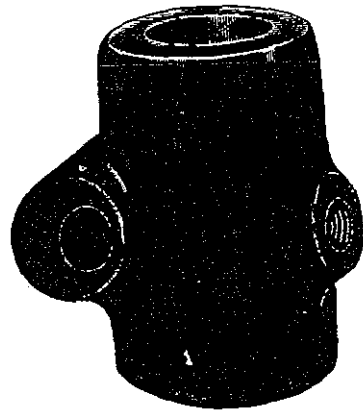

21217A



51170C

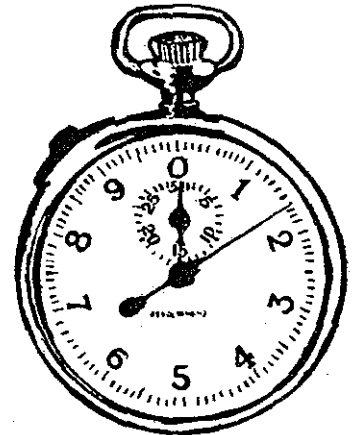

WA15

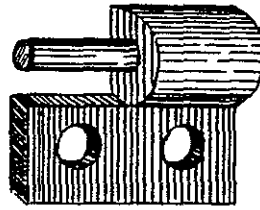

52885 G



35833 A

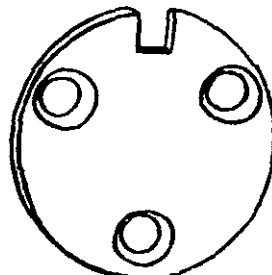

53595D

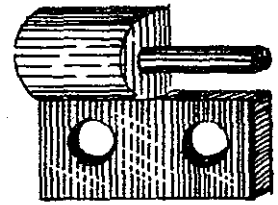

52885 H

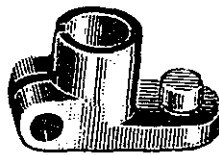

21657B

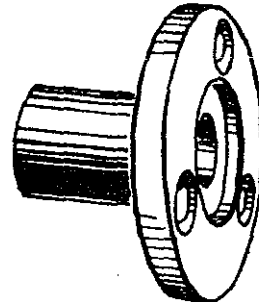

53554J



751A

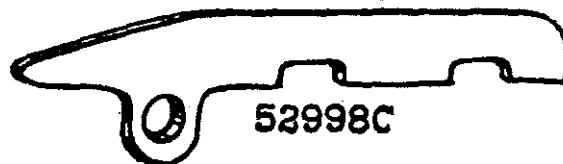

52998C



21113 B



V118

Plate 20 - Full Size

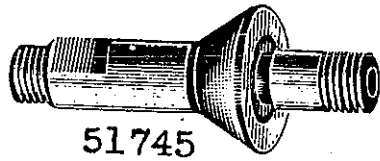

51745

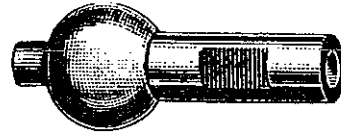

51243B

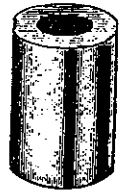

16

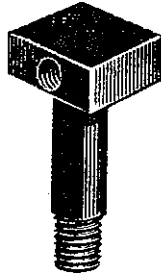

51236C

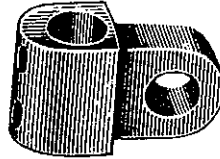

35759

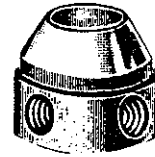

15465F



52842

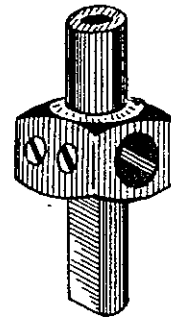

39237

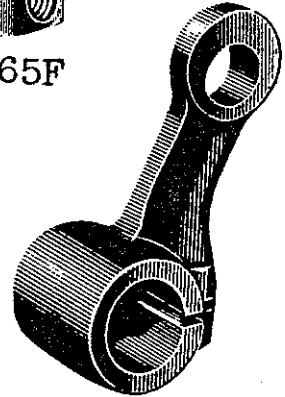

51244B

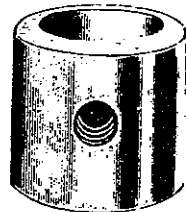

43



39236U



51243C



41255 B

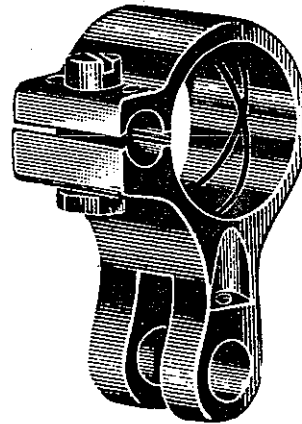

51245

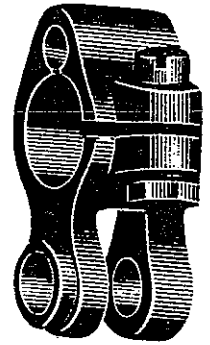

51236

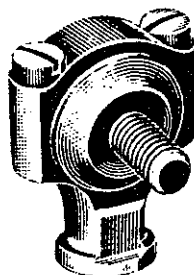

51741B

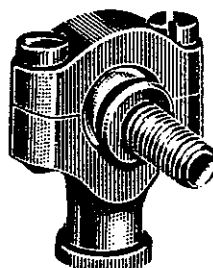

51241D

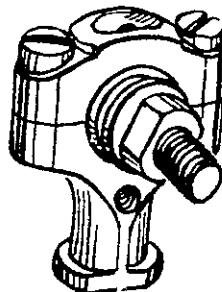

52854

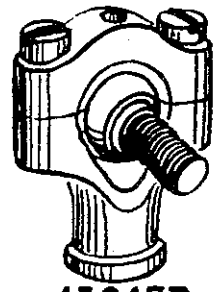

41043D

Plate 21 - One-half Size

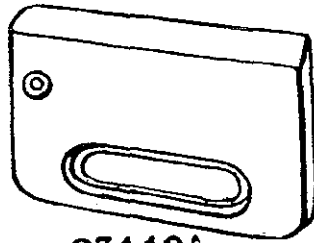

23440A

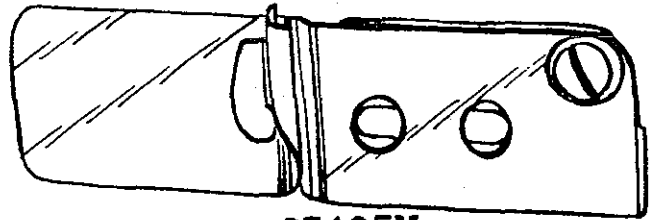

23405M

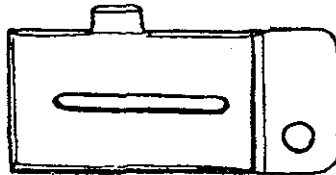

23440B



234400

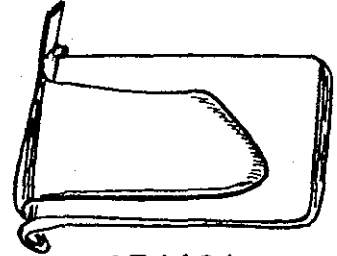

23442A

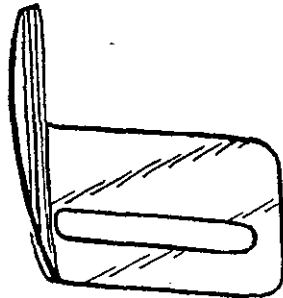

23440D

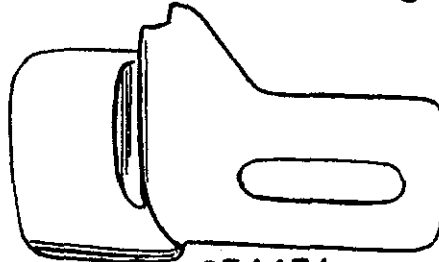

23443A



23425U

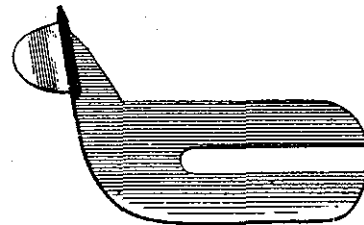

10303A



23425V

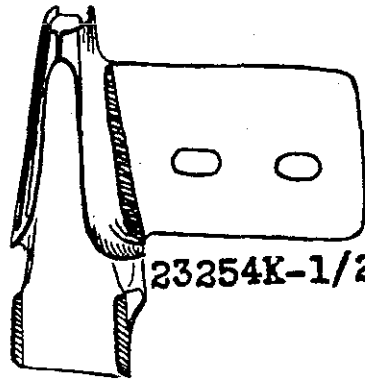

23254K-1/2



5003

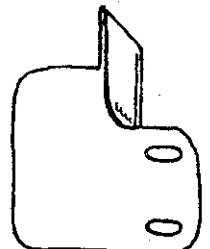

23133L

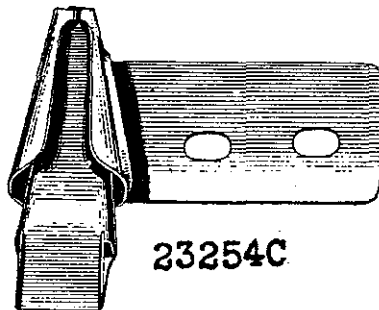

23254C

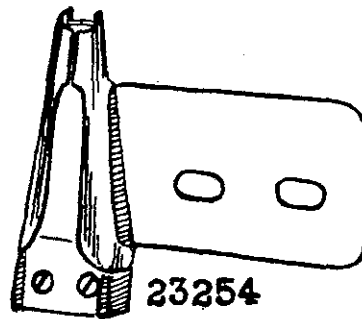

23254

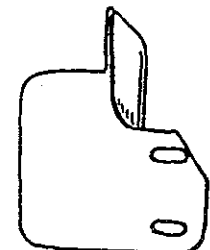

23133M

Plate 22 - One-half Size

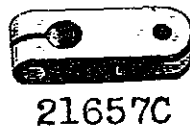
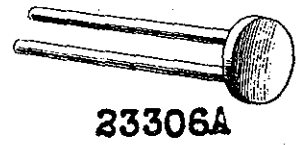
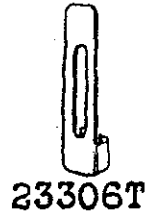
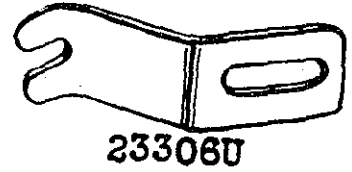
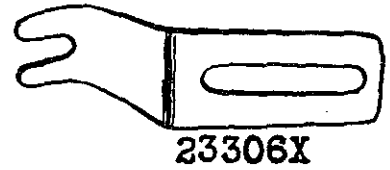
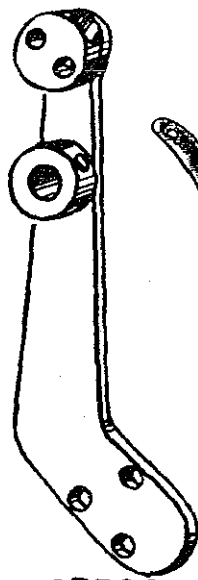

23279D

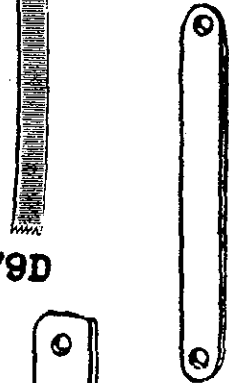

23306W

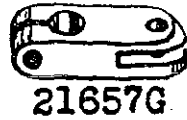
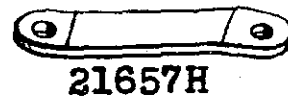
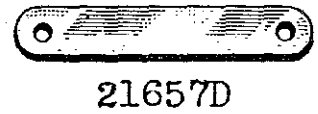
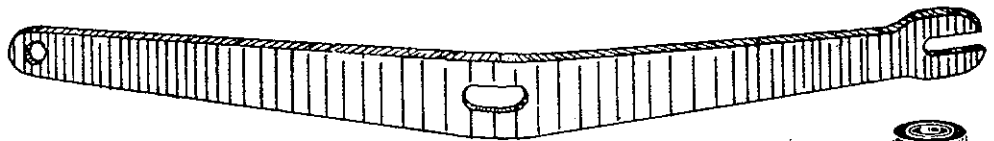

Plate 23 - One-half Size



52887



21657A



21657F



G12

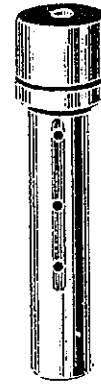

51250



51242A



52917-8



53517C-16



52817E-8



52817  
Specify  
Gauge



52717B  
Specify  
Gauge

Plate 24 - One-half Size



299



39135



424



39143G



15498L



8



51235B



51293A



15498G



35741A



53516



52888



51244A



51216



52816



HS35E



21113 A

Plate 25 - One-half Size

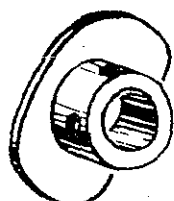

52723A

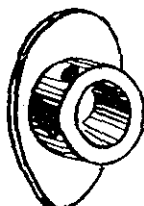

52823

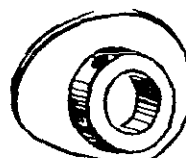

52923

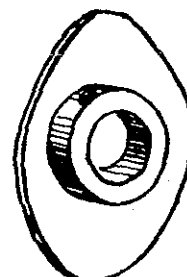

53523C



52844A

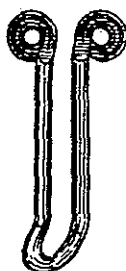

51104 D



52804A



52904

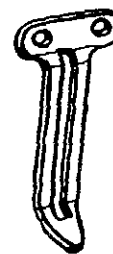

52804



52770A

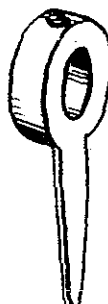

52855G



53552G



53559

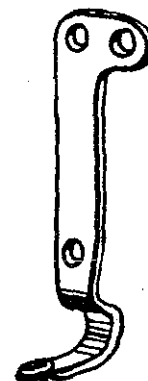

52855



52950



54

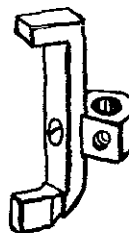

52883G



52971A

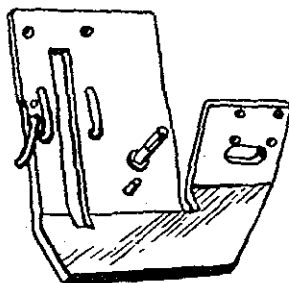

52857

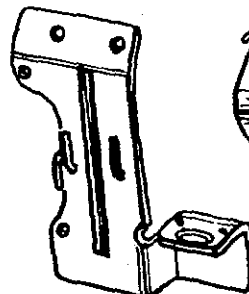

52957

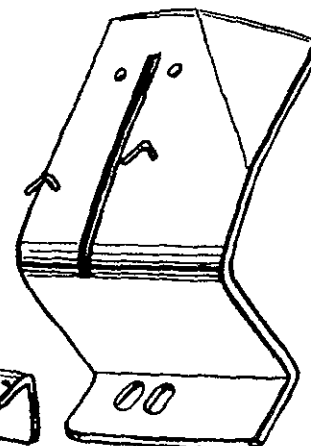

53557C



Plate 26 - One-half Size



356



243



482



9271



753



52802A

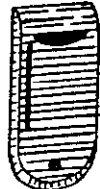

51202

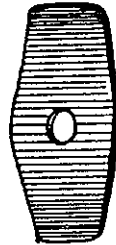

35833 C



539

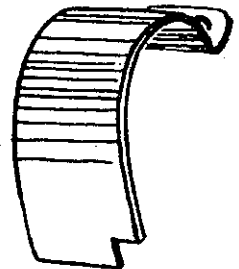

52852G

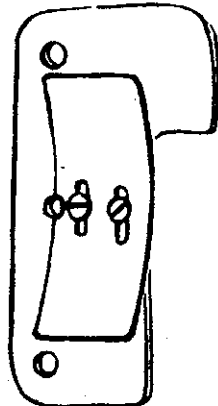

53582N



52882 D



52782H

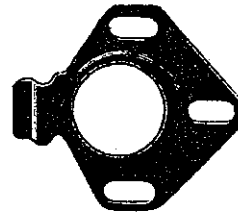

51281F



53595E

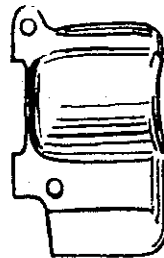

52994

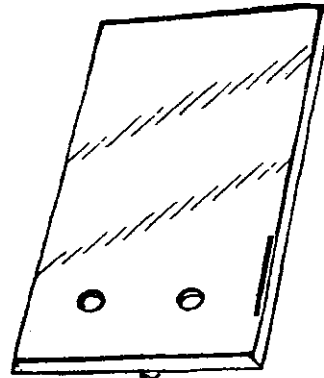

53502

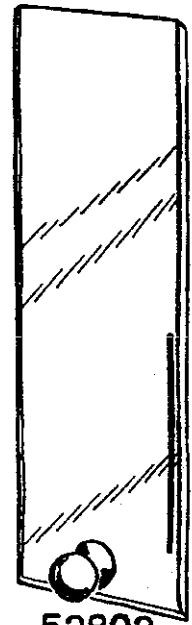

52802

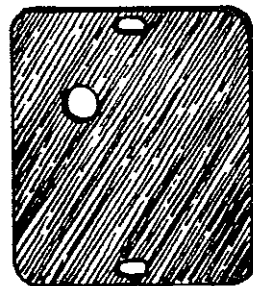

52882 B

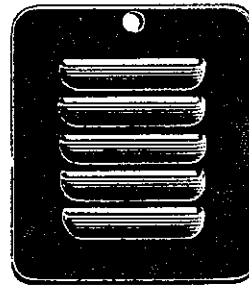

51282

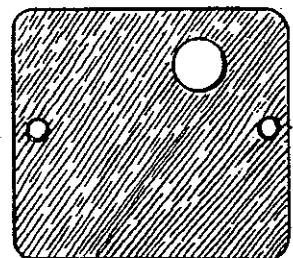

51282 H

Plate 27 - One-half Size

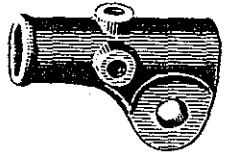

51244

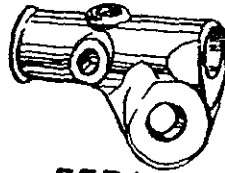

53544

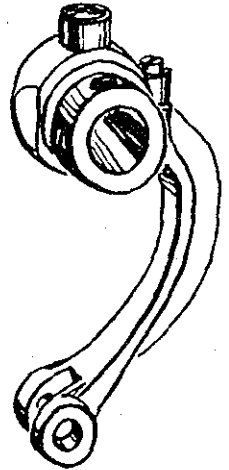

29132M

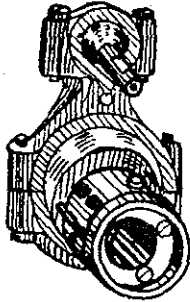

29105L

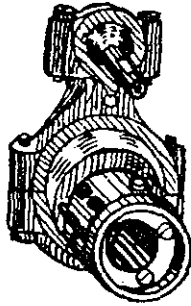

29105K

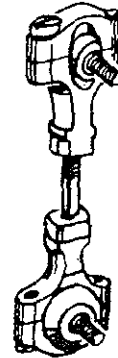

52848A



51216A

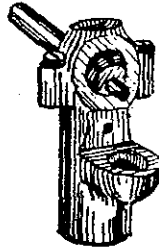

29066 F



53545

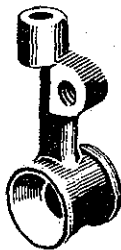

51213



52913

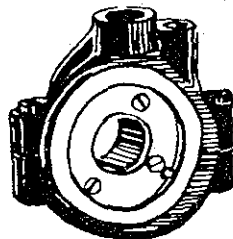

29126AK

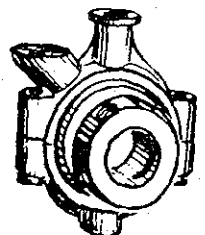

29114B

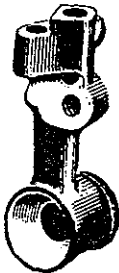

53513

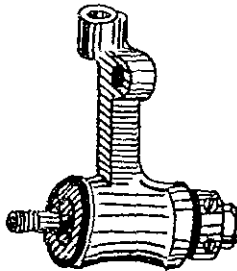

29192

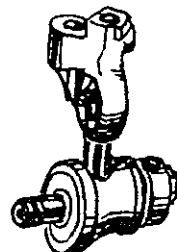

29192F

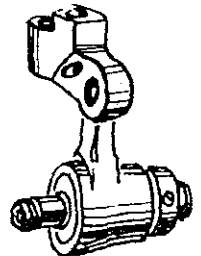

29192G

Plate 28 - One-half Size

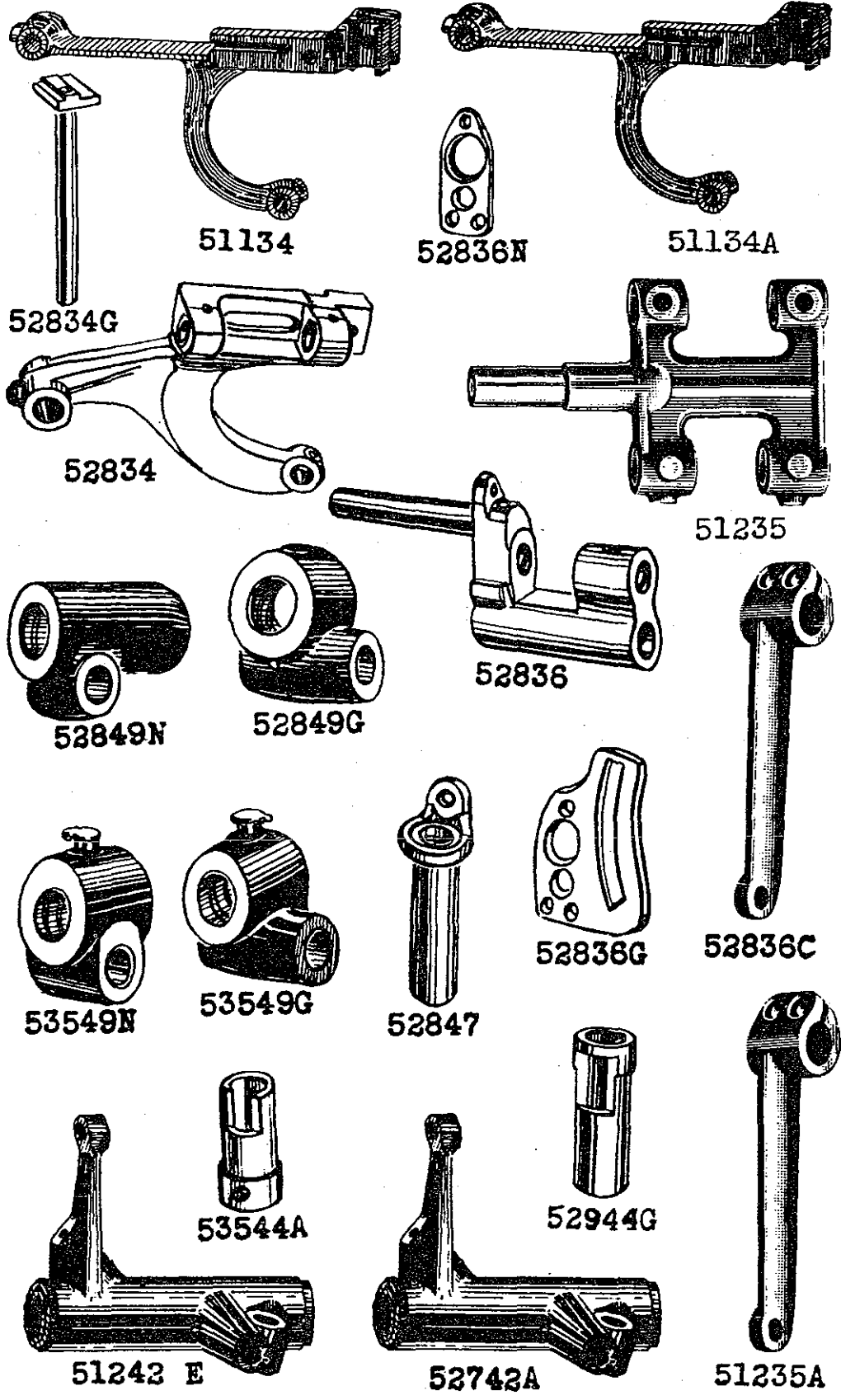
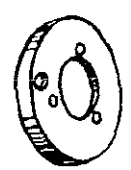
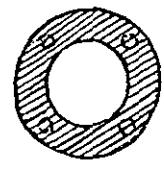

Plate 29 - One-half Size



51243K



51243L

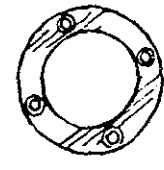

51243N

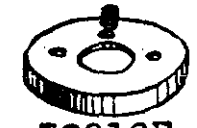

52816F



660-94



52894 J



52943A



52943B

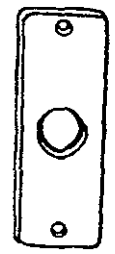

35788B



660-148

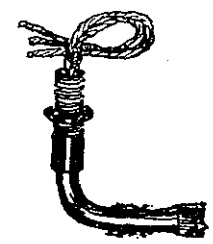

660-136

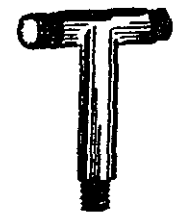

52894 Y

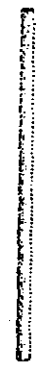

666-29

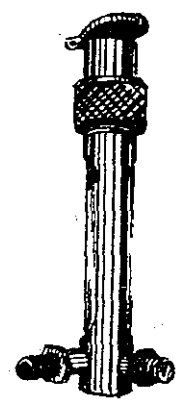

52795

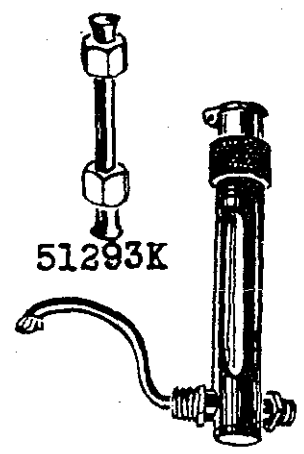

51293K

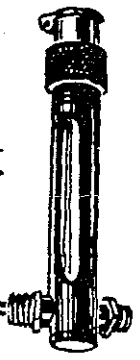

52895

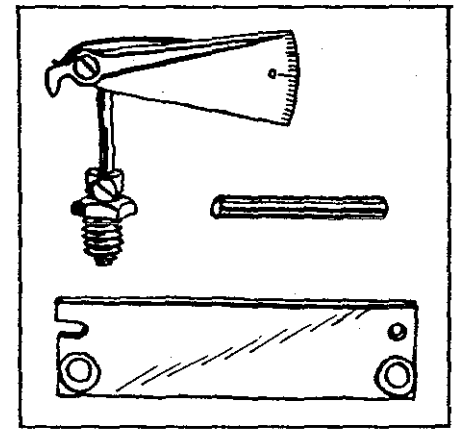

21227AC

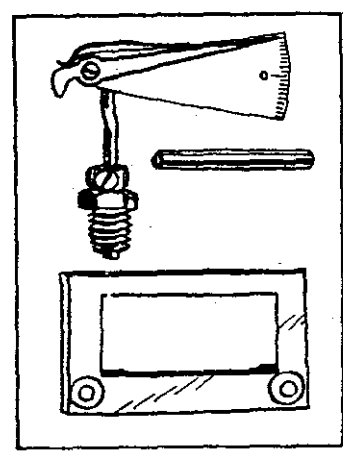

21227R

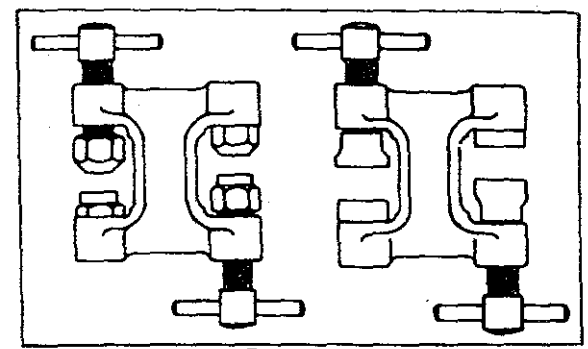

21227 HH

Plate 30 - One-half Size

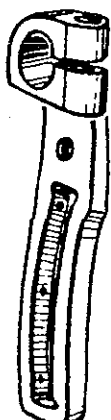

53552



52852

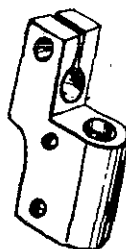

53554D



52849A



53548N

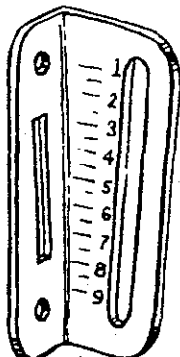

53553G



53553



53553D

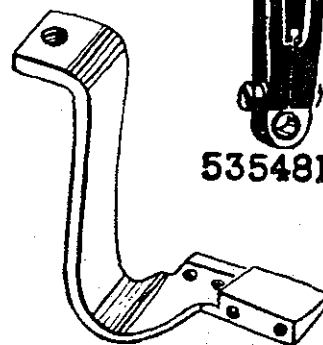

53541

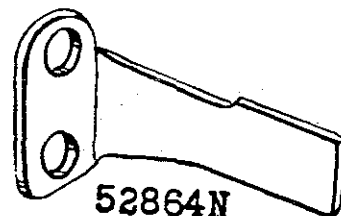

52864N



53554

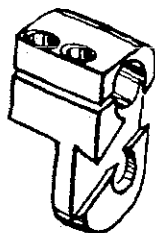

53552D



53552C

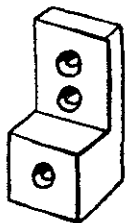

52864G

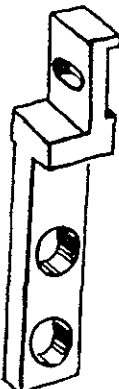

53541H

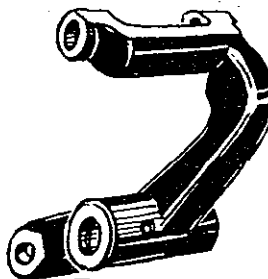

52973A

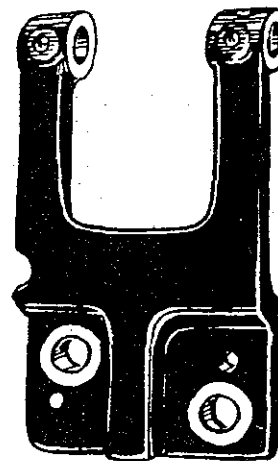

52973H

Plate 31 - One-half Size

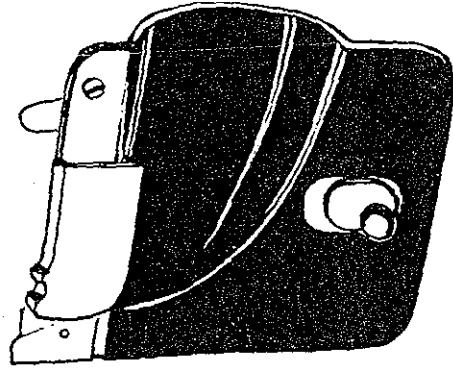

29435C

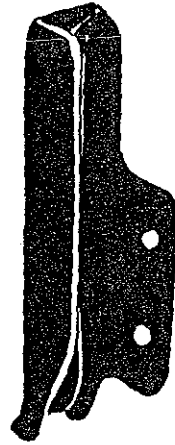

51491A

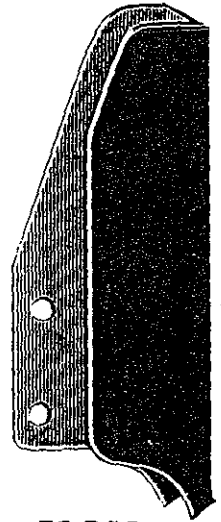

51291

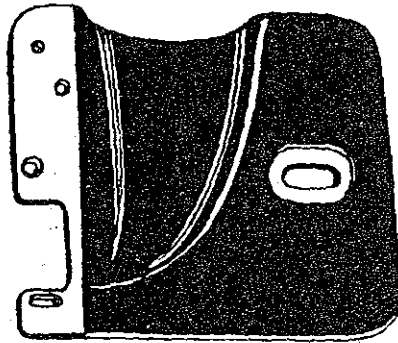

52981A



52978A-8

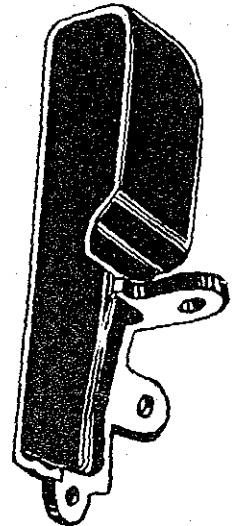

52848G

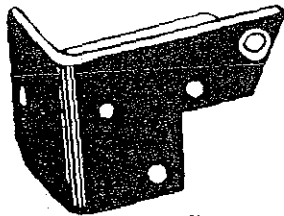

53582G

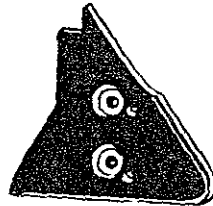

52864E



528820



52882A



51282B

Plate 32 - One-half Size

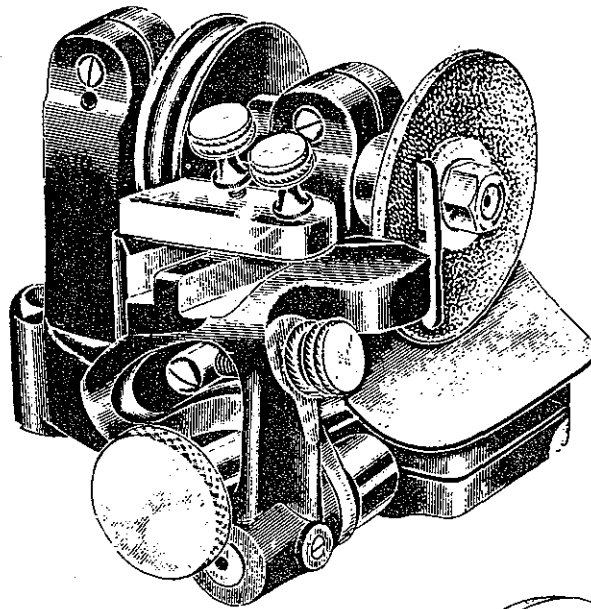

52998

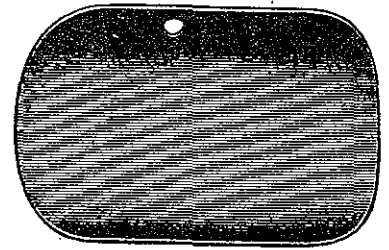

15498P

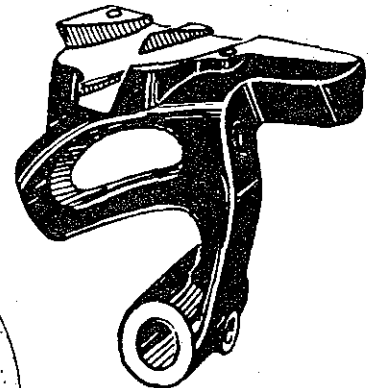

52998A

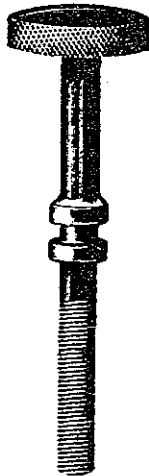

15498K

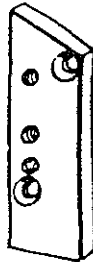

52998B

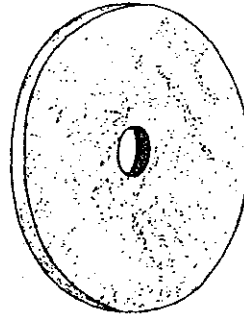

G16

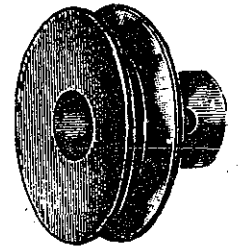

G11



15498J

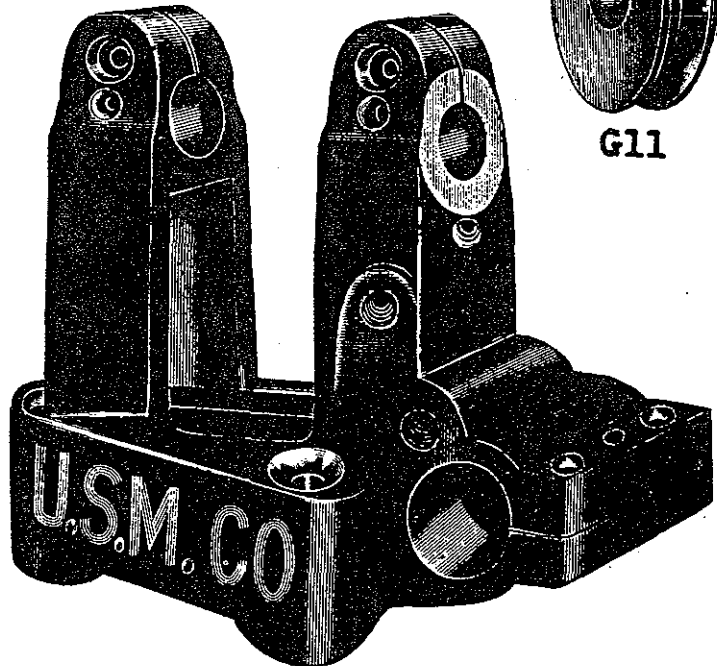

15498E

Plate 33 - One-half Size

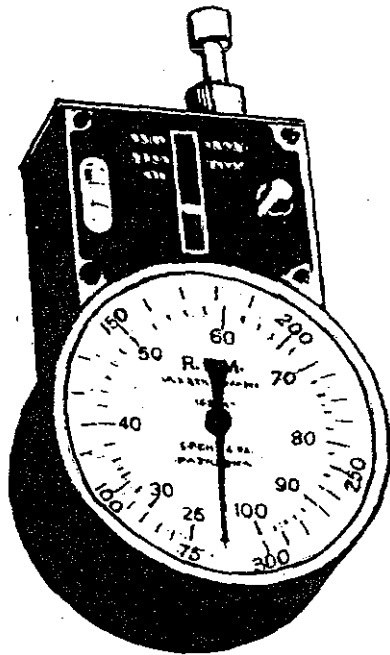

TA 55

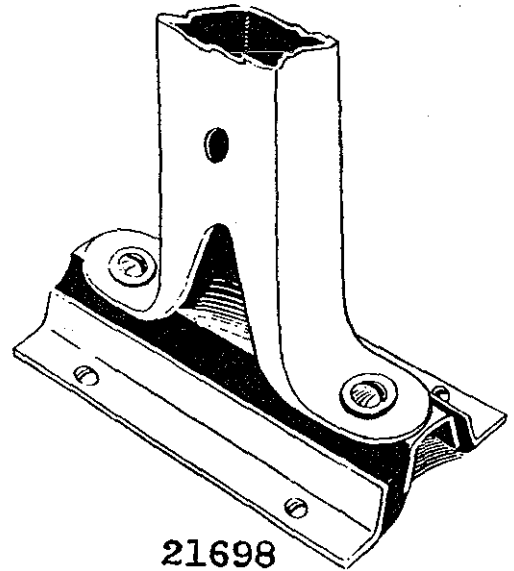

21698  
Specify Length

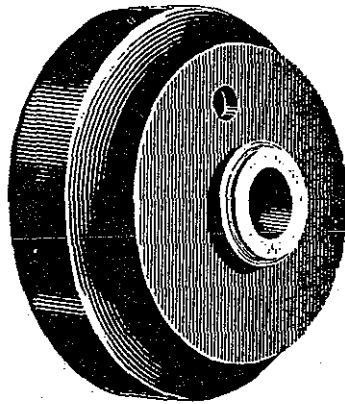

51321A



228410



423



22841B

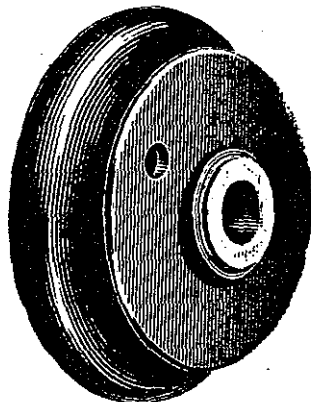

51221

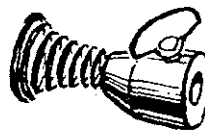

21177A



28505



43294E-108

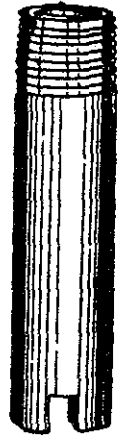

43294 D



Plate 34 - One-half Size

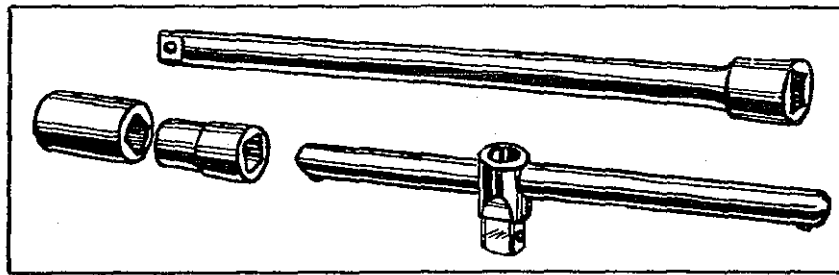

21388AE



21207



118B



21388

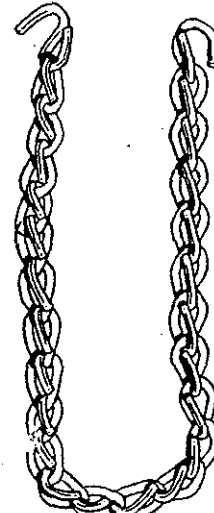

421 C  
SPECIFY  
LENGTH

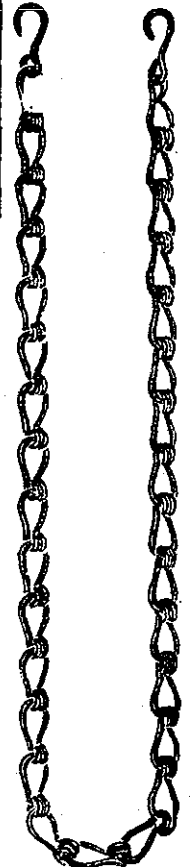

421

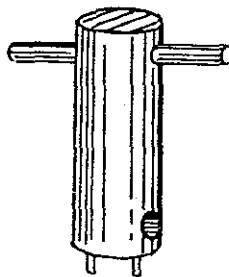

21388 Z



21388W

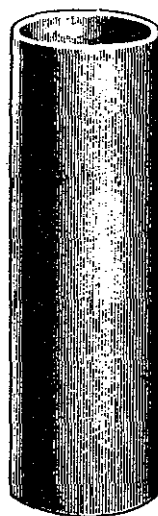

21355

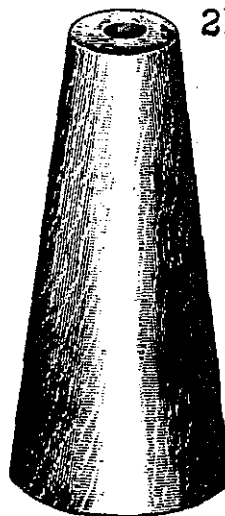

21145



21388 N

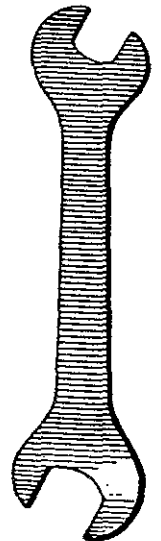

21388 R

Plate 35 - One-fourth Size

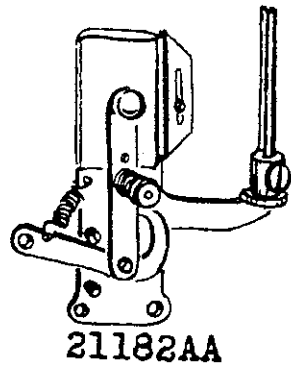

21182AA



23406K  
Specify  
Width



23406L  
Specify  
Width



23406M  
Specify  
Width



234390

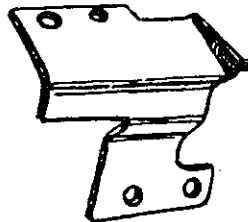

535010

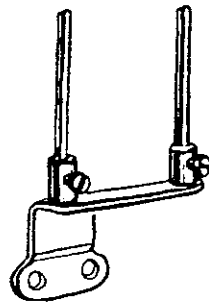

23439B

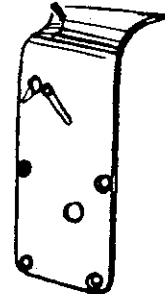

53543C

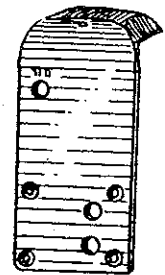

52894 G

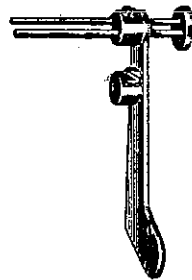

23306L

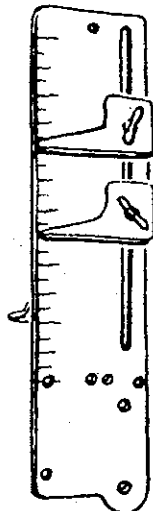

21198E

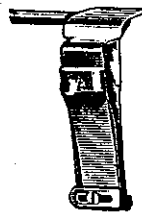

23306R

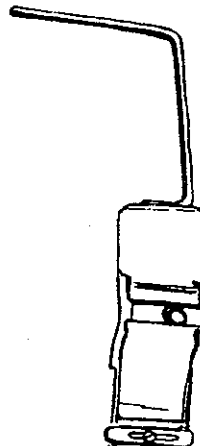

23306S

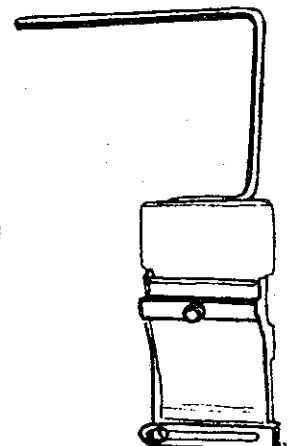

23306V

Plate 36 - One-fourth Size

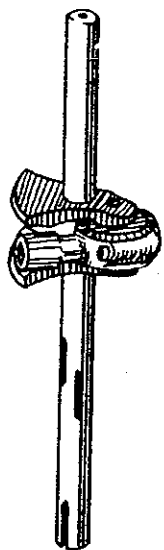

51222B

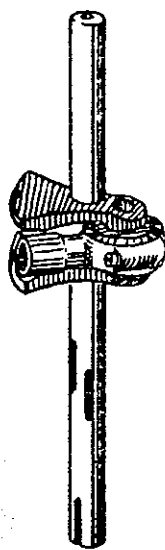

53522B



51222



52922



52864C



51282 J



52891



51290 N



52864B

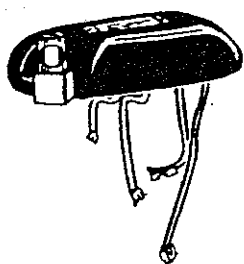

52882

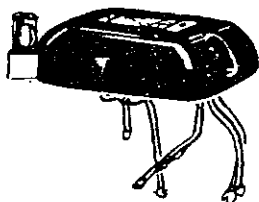

53582A



53549



52849



21104 B  
Specify Length



21218

Plate 37 - One-fourth Size

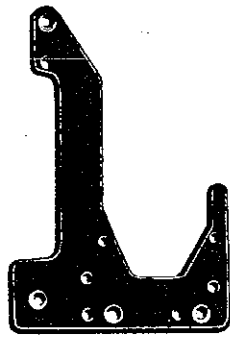

51280A

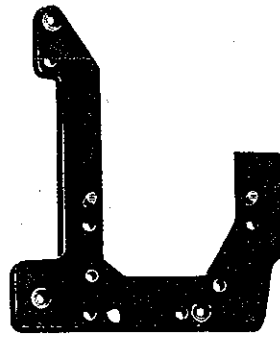

51480

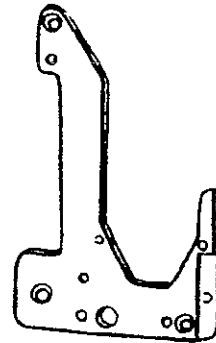

53580

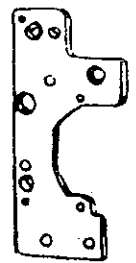

52980

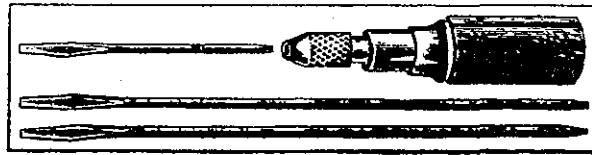

21208

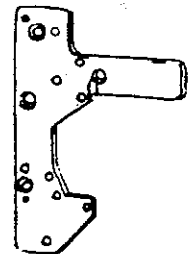

52880

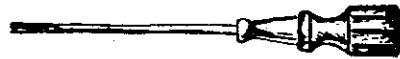

21201

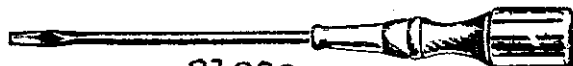

21202



21205 A

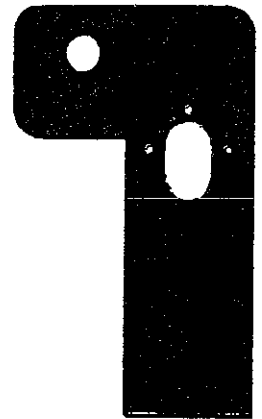

51281  
Specify  
Length

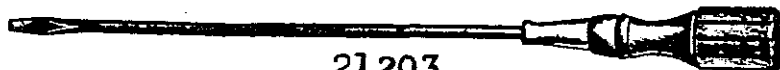

21203



21204

Plate 38 - One-fourth Size

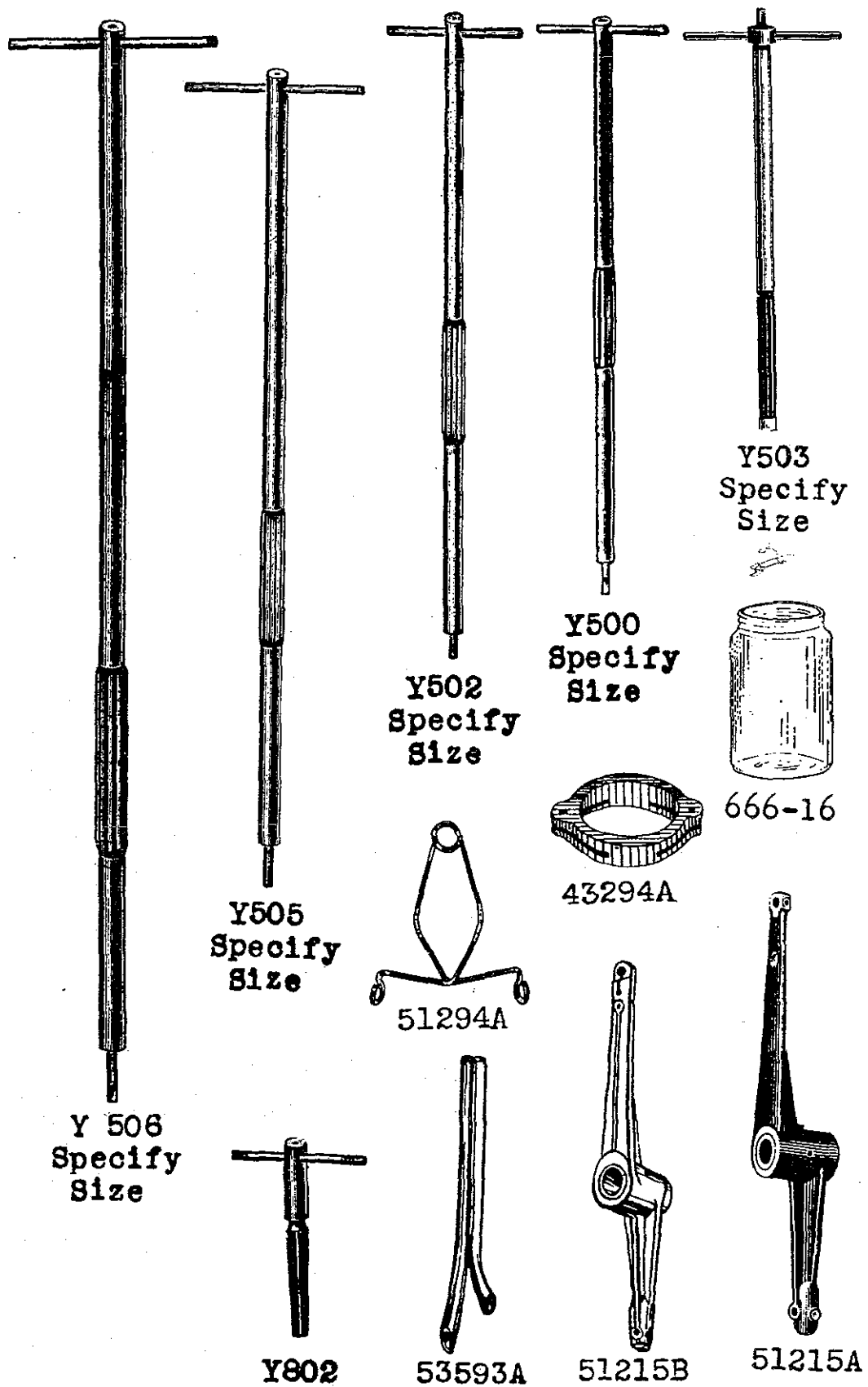
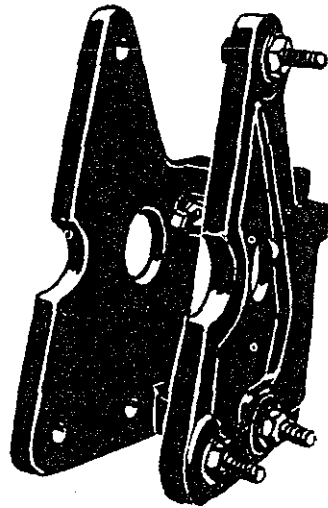
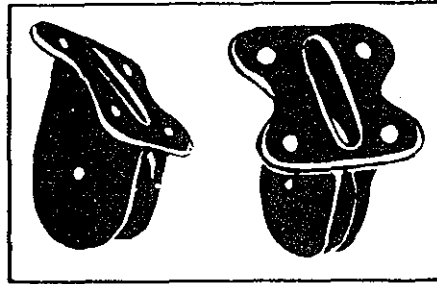

Plate 39 - One-fourth Size



21697C



660-159

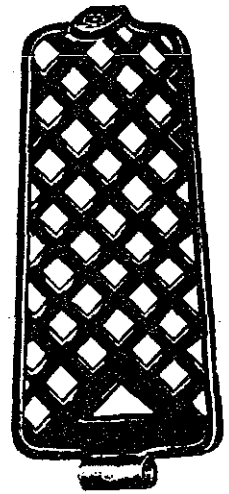

422

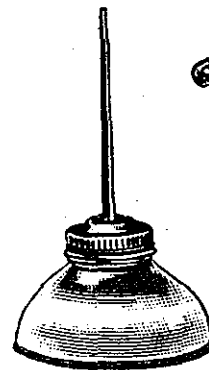
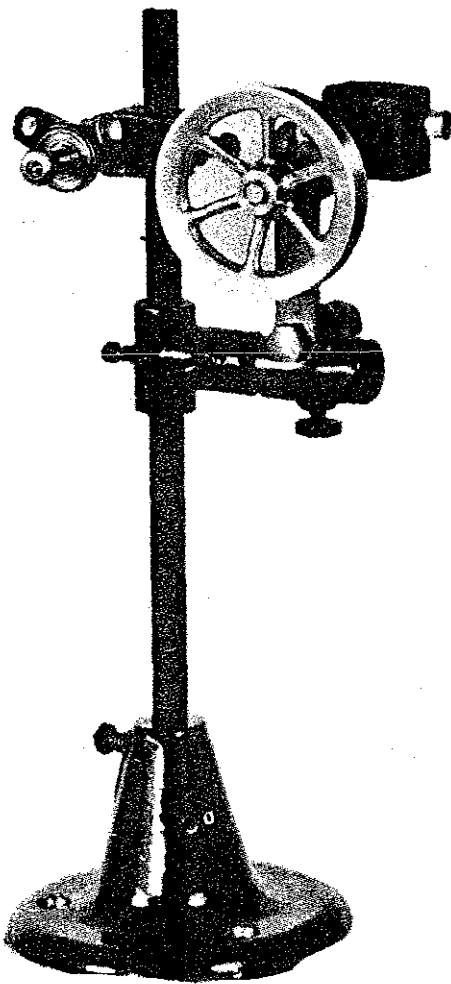

413

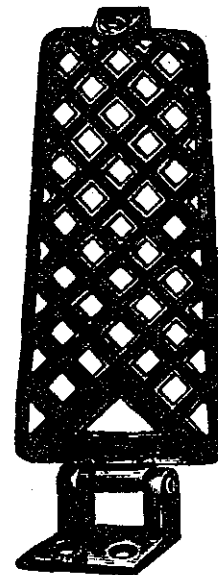

29402

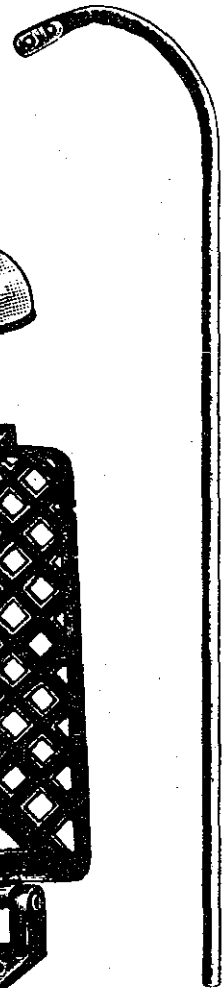

100 B

Plate 40 - One-fourth Size

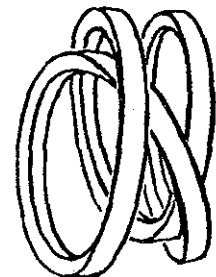
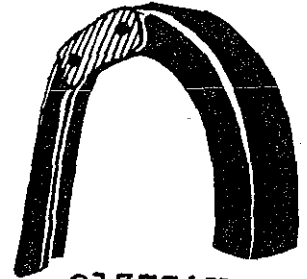
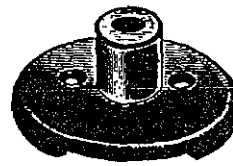
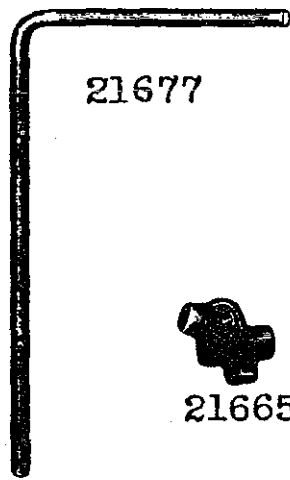

Specify Length



21679

21661

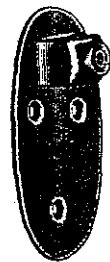

21664



21662

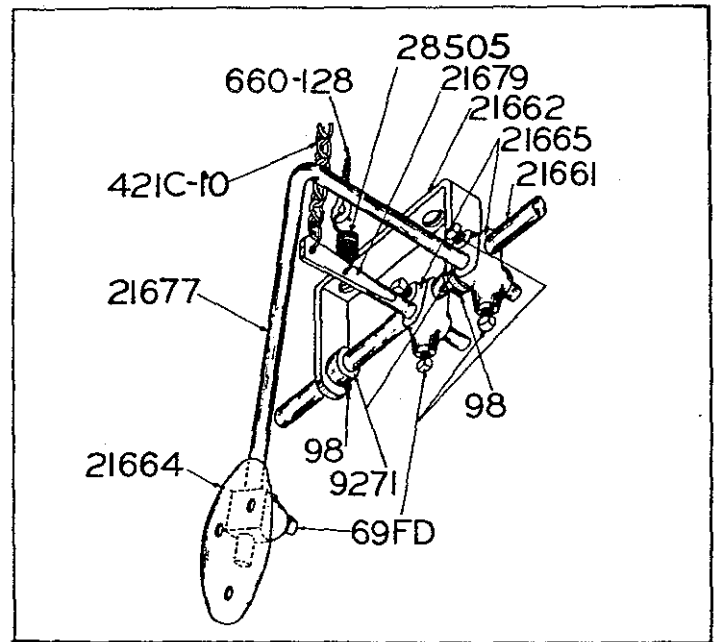

ASSEMBLY NO 21691

Plate 41 - One-eighth Size

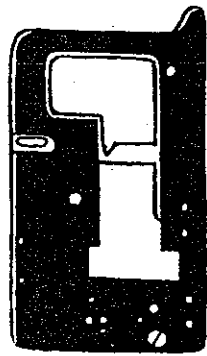

51201B

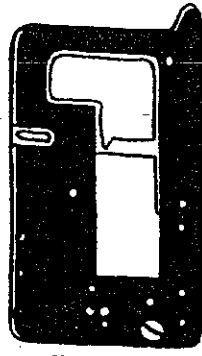

51301A

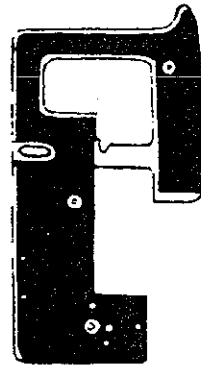

53501

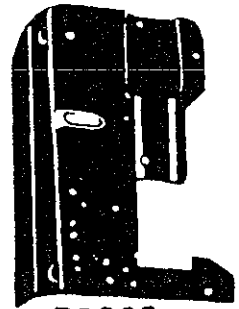

52801

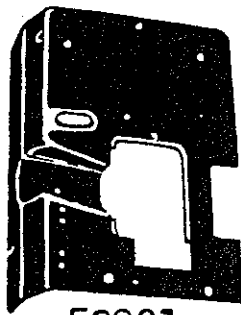

52901



52864



52885A

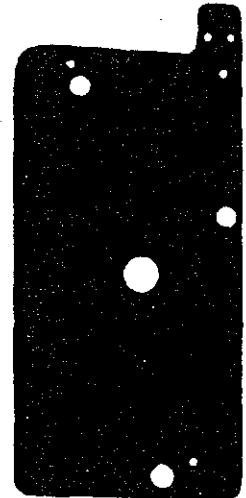

21680AK

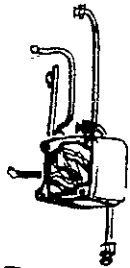

52943C

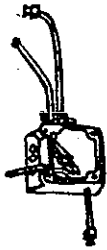

52894A



51743B



52883



51283

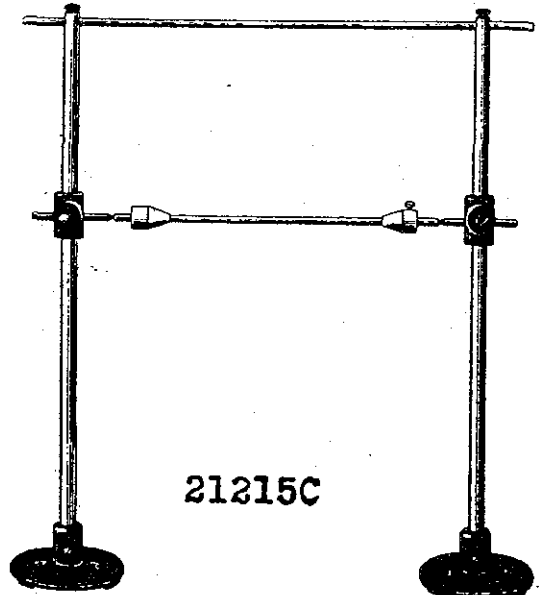

21215C



Plate 42 - One-eighth Size

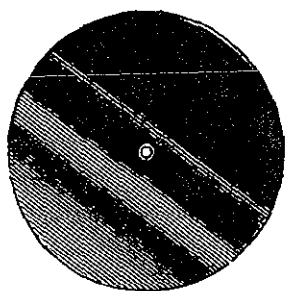

21178A



21169F

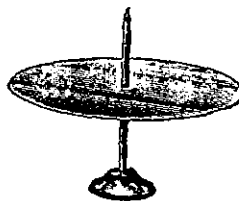

21169D

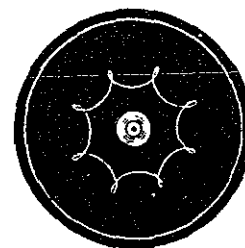

21169E



21104 A



69 S



21388 X



752



21102B

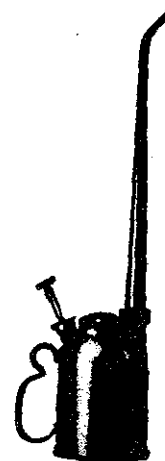

01-19

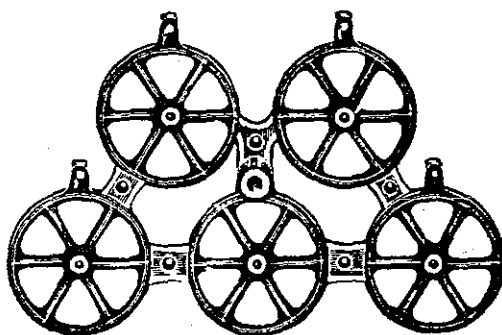

21130A-5

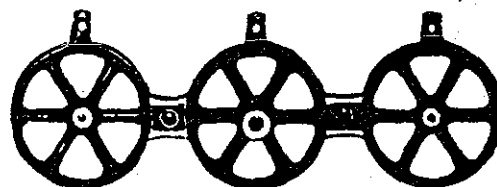

21130 A-3

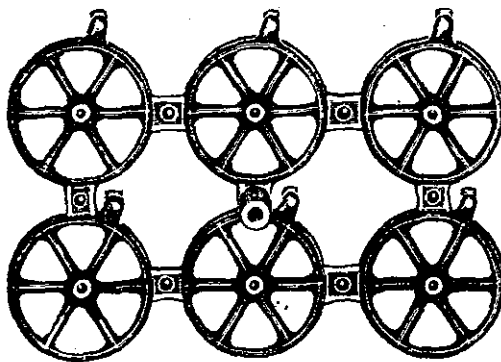

21130A-6

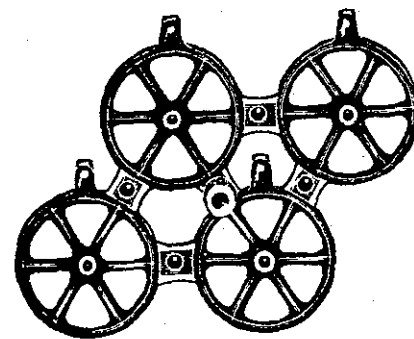

21130A-4

Plate 43 - One-eighth Size

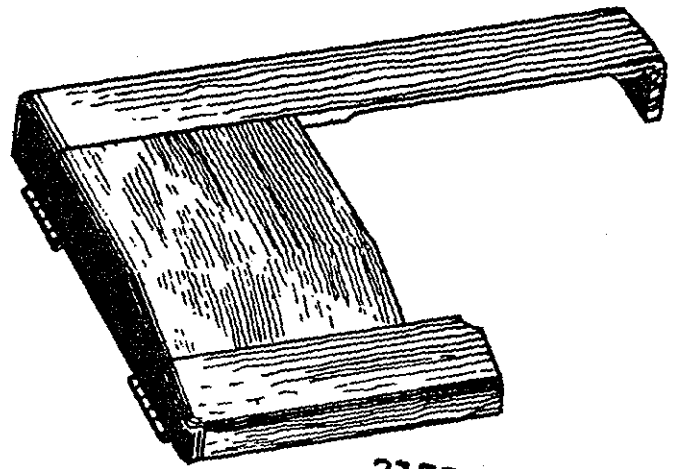

21377AN

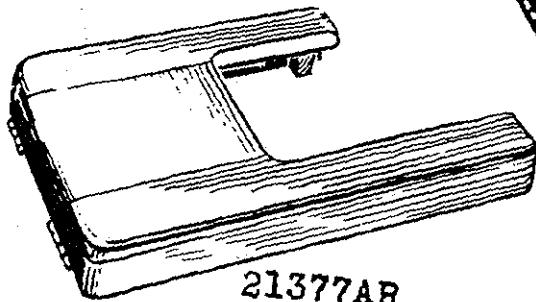

21377AR

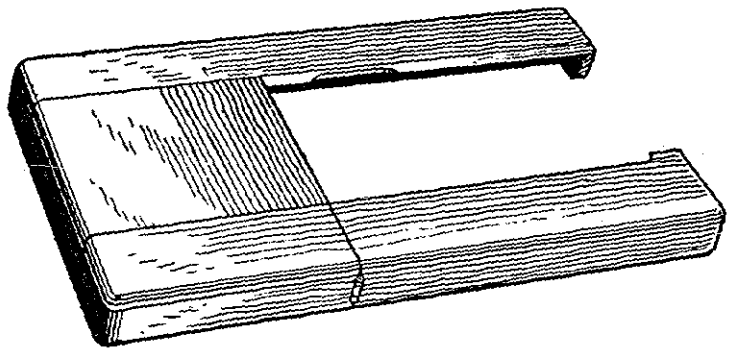

21377AL

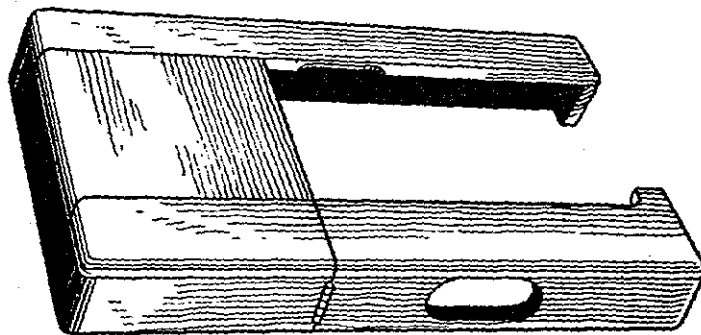

21377AX

LIST OF PARTS

Symbol to Order by	The figures in the last column refer only to the plates illustrating the parts and are not to be used in ordering. Refer to pink insert for prices.	Plate No.
8	Feed Rocker Shaft, for styles in Classes 52800, 52900; Style 52700 F - - - - -	24
G10	Thumbscrew, for holding knives in grinder No. 52998 - - - - -	11
G11	Pulley, for knife grinder No. 52998 (screw No. 98) - - - - -	32
G12	Pulley Spindle, for knife grinder No. 52998 (clamp screw No. 136) - - - - -	23
G14	Pulley Spindle Washer, for knife grinder No. 52998 - - - - -	13
G15	Pulley Spindle Nut, for knife grinder No. 52998 - - - - -	12
WA15	Stop Watch- - - - -	19
16	Feed Crank Link Ferrule - - - - -	20
G16	Emery Wheel, for knife grinder No. 52998- - -	32
18	Looper Connecting Rod Nut, right thread; also for No. HS35 E- - - - -	12
OI-19	Pressure Pump Oil Can, 1 1/2 pints capacity	42
20	Feed Crank Stud Washer; also for Nos. 539, 51758, 51958 B- - - - -	13
22 JE	Feed Dog, for No. 16 gauge Style 52700 B- - -	3
22 JW	" " for No. 16 gauge Style 52700 H- - -	4
	" " Screw No. 22528	
25 B	Screw, for stripper blade on styles in Class 53500; also for Nos. 23306 T, 23306 W - - -	9
25 C	Screw, 9/32 inch long, for cloth plate attachments - - - - -	10
25 S	Screw, for folder clamp on Styles 52800 E, 52800 F, 52800 H, 52800 K; also for No. 21198 E - - - - -	10
25 CC	Screw, for folders on Styles 52800 E, 52800 F, 52800 H, 52800 K; also for Nos. 23306 R, 23306 S, 23306 V - - - - -	9
28	Screw, for cast-off plate; also for Nos. 53546-16, 53548 S - - - - -	9
28 B	Set Screw, for needle holder thread guide on styles in Classes 52800, 52900- - - - -	9
28 C	Set Screw, for rear needle on styles in Class 52900; also for Nos. 52842 G, K5286- - - -	9
HS35 E	Ruffler Eccentric Connecting Rod, for Style 53500 D (nut, right thread, No. 18, nut, left thread, No. 269) - - - - -	24
36 G	Looper Connecting Rod Ball Stud Washer; also for No. 52848 A - - - - -	13
37 L	Ruffler Eccentric Upper Connecting Rod Nut, left thread, for Style 53500 C- - - - -	12
37 R	Ruffler Eccentric Upper Connecting Rod Nut, right thread, for Style 53500 C - - - - -	12

LIST OF PARTS

Symbol to Order by	The figures in the last column refer only to the plates illustrating the parts and are not to be used in ordering. Refer to pink insert for prices.	Plate No.
43	Feed Lift Eccentric; also looper avoid eccentric (spot screw No. 96) - - - - -	20
50 J-16	Needle Stop Pin, 7/16 inch long, for styles in Class 52900- - - - -	12
50 J-26	Needle Stop Pin, 19/32 inch long, for styles in Class 53500- - - - -	12
52 A	Frame Thread Eyelet; also for No. 52894 G (screw No. 98 A and 87 U) - - - - -	15
54	Needle Lever Link - - - - -	25
TA54	Hand Tally- - - - -	--
TA55	Hand Tachometer, 4 speed type, 90 to 12000 R.P.M.- - - - -	33
57 WB	Needle Bar Thread Nipper Plate, for styles in Class 53500 - - - - -	15
57 WC	Needle Bar Thread Nipper Spring - - - - -	14
57 WD	Needle Bar Thread Nipper Stud; also for Nos. 15480 C, 52730 M, 52830 G - - - - -	10
HA61 D	Screw, for ruffler adjusting lever stop bracket on Style 53500 C- - - - -	10
64 A	Swinging Frame Adjusting Screw, for knife grinder No. 52998 - - - - -	11
64 B	Swinging Frame Adjusting Screw Lock Nut, for knife grinder No. 52998 - - - - -	12
69 S	Spool Pin, 4 inches long, for thread stand- - - - -	42
69 FD	Screw, square head, cup point, 5/16 inch diameter, 18 threads, 5/8 inch long, for thread stand seat; also for Nos. 21664, 21665 - - - - -	11
73	Set Screw, for loopers- - - - -	9
73 A	Screw, for looper needle guards; also for Nos. 41076 D, 53548 P - - - - -	9
HA73 B	Screw, for knife holder rocker arm on styles in Class 52900- - - - -	9
74	Clamp Screw, for ruffler adjusting segment lever on Style 53500 C- - - - -	11
75	Screw, for feed rocker segment slot plate on styles in Class 52800; Style 52700 F; also for No. 53548 N - - - - -	11
75 A	Screw, for needle lever connecting rod bearing, lower- - - - -	11
77	Set Screw, for feed crank link pin; also for No. 39135 - - - - -	9
78	Set Screw, for lower needle lever link pin- - - - -	9
79	Screw, for cast-off wire support on styles in Class 53500; also for No. 52864 G - - - - -	10
80	Screw, for cloth plates; also throat plate support screw for Styles 52700 G, 52700 H, 53500 C, 53500 D- - - - -	10

LIST OF PARTS

Symbol to Order by	The figures in the last column refer only to the plates illustrating the parts and are not to be used in ordering. Refer to pink insert for prices.	Plate No.
81	Spot Screw, for ruffler operating lever on styles in Class 53500; also for No. 29114 B - - -	10
87	Screw, countersunk head, 1/4 inch long, for throat plates; also for No. 53595 D - - - - -	9
87 A	Screw, countersunk head, for oil reservoir cover	9
87 U	" for oil reservoir thread eyelet - - - - -	9
88	Screw, for looper rocker cone; also for Nos. 161, 1287, 1288, 5120 B, 12865, 21113 B, 52818-8, 52846, 53552 C - - - - -	9
88 A	Set Screw, for needle bar - - - - -	9
88 B	Screw, for looper rock shaft sleeves; also for Nos. 52818-8, 52918-5-8 - - - - -	9
89	Spot Screw, for needle holders; also for Nos. 52836, 52883 G, 53523 C - - - - -	9
90	Screw, for louver cover; also for Nos. 3026 A, 5026 A, 5126, 5126 B, 23306 L, 23306 M, 23442 A, 43281 K, 52770 A, 52826 G, 52826 K, 52844 A, 52864 B, 52864 C, 52864 E, 52882 B, K53189 - - - - -	9
91	Clamp Screw, 3/8 inch long, for presser feet - - -	9
93	Screw, for main oil reservoirs; also for Nos. 5650, 13153, 21375 AH, 51235 A, 51244 B, 52836 C, 52849 A - - - - -	10
93 A	Screw, for spreader connecting rod guard on styles in Classes 52800, 52900; also for Nos. 15498 H, 53559 - - - - -	9
94	Screw, for measuring gauge brace on Style 52800 E	9
95	Set Screw, for main shaft collar; also for Nos. 29114 B, 29126 AK, 52855 G - - - - -	9
96	Spot Screw, for feed lift eccentrics; also for Nos. 29105 K, 29105 L, 29132 M, 51244, 52723 A, 52823, 52923, 53544 - - - - -	9
97	Screw, for needle lever ball stud guide fork; also for Nos. 53553, 53554 J - - - - -	10
97 A	Screw, for looper drive connection; also for Nos. 41043 D, 51216 A, 51241 D, 51741 B, 52854, 53545 - - - - -	10
98	Set Screw, 3/16 inch long, without pilot, for needles; also for Nos. G11, 267, 482, 9271, 9660 B, 29105 K, 29105 L, 51235, 51244, 53544	9
98 A	Screw, for frame thread eyelets - - - - -	9
100 B	Thread Stand Wire, 16 inches long (set screw No. 22632 F-24) - - - - -	39
109	Tension Disc, with contact surface 5/64 inch wide, for machines using needle threads the equivalent in size of No. 50 and smaller - - - -	15
109 B	Tension Disc, with contact surface 1/8 inch wide, for machines using needle threads the equivalent in size of No. 40 and larger - - - - -	15

LIST OF PARTS

Symbol to Order by	The figures in the last column refer only to the plates illustrating the parts and are not to be used in ordering. Refer to pink insert for prices.	Plate No.
110-3	Tension Spring, .040 inch diameter wire, for needle threads on styles in Class 53500 - - -	14
112 DW	Throat Plate, for No. 16 gauge Style 52700 H (screw No. 87)- - - - -	2
118 B	Thread Tweezer- - - - -	34
V118	Tap, marked "X2" for plus size cloth plate screw No. 22521 - - - - -	19
136	Screw, for ruffler indexed segment guide block on Style 53500 D; also for Nos. G12, 15498 J	11
158 A	Frame Thread Eyelet, with three holes, for styles in Classes 52900, 53500, Styles 52700 F, 52800 B, 52800 D, 52800 K (screw No. 98 A) - - - - -	15
158 B	Frame Thread Eyelet, with two holes, for Styles 52700 A, 52700 B, 52700 G, 52700 H, 52800 E, 52800 F, 52800 G, 52800 H, 52800 J, 52900 A, 52900 B (screw No. 98 A)- - - - -	15
161	Collar, for binding holder disc on Styles 52800 E, 52800 F, 52800 H, 52800 K (screw No. 88) - - - - -	12
166	Set Screw, hexagonal head, for feed bar on styles in Class 52900 - - - - -	9
187 A	Screw, for knife eccentric oil guard on styles in Class 52900; also for Nos. 15180 B, 23195, 23440 C, 52782 H, K53259 - - - - -	9
187 B	Screw, for presser foot edge guide on styles in Class 53500- - - - -	9
188 D	Thumbscrew, for edging spool holder adjustable cone on Styles 52700 F, 52700 G, 52700 H; also for No. 23439 C- - - - -	10
223 C	Pivot Screw, for presser foot hinged section on Style 52700 F- - - - -	9
236	Pivot Screw, for cloth plate swinging arm on styles in Class 52800; Style 52700 F- - - - -	11
243	Cloth Plate End Cover Spring, for styles in Classes 52800, 52900; Style 52700 F (screw No. 22711)- - - - -	26
258 A	Looper Rocker Cone Nut; also for Nos. 35833 A, 51134 G - - - - -	12
267	Swinging Frame Pivot Pin Collar, for knife grinder No. 52998 (screw No. 98)- - - - -	12
269	Looper Connecting Rod Nut, left thread; also for Nos. HS35 E, 51236 C, 52816 - - - - -	12
299	Ruffler Adjusting Block Pivot Pin, for Style 53500 C - - - - -	24
356	Spring, for locating cloth plate cover on styles in Class 52900 (screw No. 22561)- - -	26
357	Screw, for edge guide on Styles 52700 F, 52800 G	9

LIST OF PARTS

Symbol to Order by	The figures in the last column refer only to the plates illustrating the parts and are not to be used in ordering. Refer to pink insert for prices.	Plate No.
358 B	Cloth Plate Sliding Cover Knob, for styles in Classes 52800, 53500 - - - - -	--
376	Screw, for supplemental face plate on styles in Class 53500- - - - -	9
402	Stop Screw, for intermittent strip tension operating lever on Style 52800 E- - - - -	10
413	Oil Can, complete - - - - -	39
421	Lifter Lever Chain, 38 inches long- - - - -	34
421 C-10	Knee Press Chain, 10 inches long- - - - -	34
422	Lifter Treadle- - - - -	39
423	Lifter Treadle Base - - - - -	33
424	Lifter Treadle Pin (screw No. 22813)- - - - -	24
426 A	Lifter Lever Spring Pin, for styles in Class 53500 - - - - -	13
482	Feed Rocker Shaft Collar (screw No. 98) - - - - -	26
Y500-257	Expansion Reamer, for needle bar bearings, size .257 inch- - - - -	38
Y502-319	Expansion Reamer, for upper presser bar bear- ing, size .319 inch - - - - -	38
Y503-319	Expansion Reamer, for lower presser bar bear- ing, size .319 inch - - - - -	38
Y505-407	Expansion Reamer, for looper rocker and feed rocker shaft bearings, size .407 inch - - - - -	38
Y506-530	Expansion Reamer, for main shaft bearings, size .530 inch- - - - -	38
522	Face Plate Stop, for styles in Classes 52800, 52900 (screw No. 604) - - - - -	14
538	Screw, for supporting feed dogs on styles in Classes 52900, 53500, Styles 52700 A, 52700 B, 52700 G, 52700 H - - - - -	9
539	Frame Thread Eyelet, 2 1/4 inches long, for styles in Classes 52900, 53500 (screw No. 22848, washer No. 20) - - - - -	26
604	Screw, for presser foot adjustable guide on Styles 52700 G, 52700 H; also for No. K54743	9
605	Screw, for crank chamber oil reservoir cover; also for Nos. 3040, 5140, 11534, 16194, 52930 F - - - - -	9
605 A	Adjusting Screw, for presser foot yielding section spring on Styles 52800 J, 52800 K	9
650 A-16	Stove Bolt, flat head, 5/16 x 2 inches- - - - -	--
650 A-18	Stove Bolt, flat head, 5/16 x 2 1/4 inches- - - - -	--
650 A-20	Stove Bolt, flat head, 5/16 x 2 1/2 inches- - - - -	--
650 B-26	Stove Bolt, flat head, 3/8 x 3 1/4 inches, for table tops- - - - -	--
650 X-18	Carriage Bolt, 5/16 x 2 1/4 inches, for attaching "Electro Drive" - - - - -	--
650 X-22	Carriage Bolt, 5/16 x 2 3/4 inches, for attaching "Electro Drive" - - - - -	--

LIST OF PARTS

Symbol to Order by	The figures in the last column refer only to the plates illustrating the parts and are not to be used in ordering. Refer to pink insert for prices.	Plate No.
650 X-32	Carriage Bolt, 5/16 x 4 inches for attaching "Electro Drive" - - - - -	---
651 D-24	Nut, 3/8 inch, square - - - - -	---
652-16	Washer, 1/4 inch - - - - -	---
652-20	" 5/16 inch - - - - -	---
652-24	" 3/8 inch - - - - -	---
652 C-9	Shake Proof Lock Washer, for needle bar eyelet	13
660-90	Felt Wiper, for looper drive eccentric connection - - - - -	17
660-92	Leather Washer, upper, 3/16 inch hole, for main shaft oil gauge; also for No. 39193 - -	13
660-93	Leather Washer, lower, 1/4 inch hole, for main shaft oil gauge; also for No. 39193- - - -	13
660-94	Glass Tube, for main shaft oil gauge - - - -	29
660-95	Cap, for main shaft oil gauge- - - - -	17
660-128	Wood Screw Eye, for knee press assembly on Style 53500 C- - - - -	---
660-136	Feed Crank Link Oil Tube - - - - -	29
660-143	Oil Tube, for looper drive eccentric assembly on styles in Classes 52700, 52800, 52900 - -	17
660-148	Isolated Insulator, for table top on line assembly individual power table (plain nut No. 651 D-24, cap nut No. 21371 CT, washer No. 652-24)- - - - -	29
660-159	Idle Pulleys, set of two, for leading floor treadle lifter chain away from transmitter or line shaft on American Safety Table in- stallations- - - - -	39
666-11	Oil Cup, for upper rock shaft bearings on styles in Classes 52800, 52900, 53500- - - -	17
666-13	Felt Wick, spring pressed, for main shaft bearings - - - - -	17
666-16	Reservoir Glass, for oil drain assembly- - - -	38
666-19	Felt Wick, for needle lever connecting rod bearing- - - - -	17
666-28	Oil Cup, for needle lever stud (nut No.12987A)	17
666-29	Felt Wick, for needle lever stud - - - - -	29
666-49	Glass Tube, for oil level gauge No. 39193- - -	17
666-50	Oil Cup, press fit, for upper oil reservoir cover- - - - -	17
666-53	Spreader Eccentric Connecting Rod Felt, for styles in Classes 52800, 52900 - - - - -	17
666-66	Oil Tube, for looper drive eccentric assembly on styles in Class 53500 - - - - -	17
668-7	Porcelain Thread Eyelet, 5/32 inch long, for tension thread eyelets; also for No. 52855	15
668-12	Porcelain Thread Eyelet Locking Ferrule, for tension thread eyelets; also for No. 52855	15



LIST OF PARTS

Symbol to Order by	The figures in the last column refer only to the plates illustrating the parts and are not to be used in ordering. Refer to pink insert for prices.	Plate No.
719	Set Screw, for needle lever stud; also for No. 51250 B - - - - -	10
751 A	Edging Spool Holder Pin, for Style 52800 G (thumbscrew No. 22728)- - - - -	19
752	Edging Spool Holder Axle, for Style 52800 G	42
753	Edging Spool Holder Adjustable Cone, for Style 52800 G; also elastic band spool holder adjustable cone, for Styles 52700 F, 52700 G, 52700 H (thumbscrew No. 188 D)- - - - -	26
Y802	Taper Reamer, for needle lever link and feed crank link pins- - - - -	38
907	Differential Feed Regulating Stud Nut; also for Nos. 23306 R, 23306 S, 23306 V, K53259, 53548 N - - - - -	12
1248	Feed Crank Link Shim, leather - - - - -	12
1286	Needle Lever Link Pin Assembly; also feed crank link pin assembly; one each Nos. 1286 A, 1286 B, 12964 C, 22560- - - - -	13
1286 A	Needle Lever Link Pin (set screw for upper link pin No. 77, clamp screw No. 22864, nut No. 51250 C, set screw for lower link pin No. 78) - - - - -	13
1286 B	Needle Lever Link Pin Spring (screw No. 22560)- - - - -	14
1287	Needle Bar Thread Nipper Assembly, for styles in Class 53500; one each Nos. 57 WB, 57 WC, 57 WD, 88, 1288 - - - - -	15
1288	Needle Bar Thread Nipper Collar (screw No. 88) - - - - -	15
1346	Tension Post, 1 11/16 inches long, for styles in Class 53500 - - - - -	15
1349	Tension Spring, for intermittent strip tension on Style 52800 E - - - - -	14
1594 A	Ruffler Adjusting Lever Spring Pin, for Style 53500 C - - - - -	13
3026 A	Differential Feed Dog, for Style 52800 D (screw No. 90)- - - - -	3
3040	Presser Foot Yielding Section Spring, for Styles 52700 A, 52800 B, 52800 D, 52800 J (screw No. 605) - - - - -	7
3045	Presser Foot Edging Roller, for Style 52800 G - - - - -	--
K3892	Feed Dog, for 1/2 inch belt loop on No. 16 gauge Style 52700 A (screw No. 22528) - - - - -	--
5003	Edge Guide, for Style 52800 G (pivot screw No. 22735, pivot screw washer No. 12957 E, adjustable section screw No. 357) - - - - -	21

LIST OF PARTS

Symbol to Order by	The figures in the last column refer only to the plates illustrating the parts and are not to be used in ordering. Refer to pink insert for prices.	Plate No.
5005 R	Main Feed Dog, for Style 52800 G (screw No. 22593) - - - - -	3
5024 B-12	Throat Plate, for No. 12 gauge Style 52800 J (screw No. 87) - - - - -	1
5024 M-8	Throat Plate, for No. 8 gauge Style 52800 G (screw No. 87) - - - - -	1
5026 A	Differential Feed Dog, for Styles 52800 E, 52800 F, 52800 H (screw No. 90)- - - - -	3
5041	Presser Foot Yielding Section, right, for Style 52800 B, 52800 J - - - - -	7
5042	Presser Foot Yielding Section, left, for Style 52800 J- - - - -	7
5105 B	Main Feed Dog, for Style 52800 G (screw No. 22593) - - - - -	3
G5105 B	Main Feed Dog, for Style 52700 F (screw No. 22593) - - - - -	3
5120 B	Presser Foot, for Style 52800 K (set screw No. 88, yielding section spring No. 16194, yielding section spring pin No. 8041, yielding section attaching screw No. 605, yielding section spring adjusting screw No. 605 A) - - - - -	5
5126	Differential Feed Dog, for Styles 52700 F, 52800 J (screw No. 90) - - - - -	3
5126 B	Differential Feed Dog, for Style 52800 B (screw No. 90) - - - - -	3
5127 C	Presser Foot, for Style 52800 B (clamp screw No. 91, yielding section, right, No. 5041, yielding section, left, No. 5141, yielding section spring No. 5140, yielding section spring screw No. 605)- - - - -	5
5127 H	Presser Foot, for Style 52800 D (clamp screw No. 91, yielding section spring No. 3040, yielding section spring screw No. 605) - - - - -	5
5127 J	Presser Foot, for hemming flaps on No. 12 gauge two needle styles in Class 52800 (clamp screw No. 91) - - - - -	5
5140	Presser Foot Yielding Section Spring, for Style 52800 B (screw No. 605)- - - - -	7
5141	Presser Foot Yielding Section, left, for Style 52800 B- - - - -	7
5650	Main Feed Dog Holder, for Style 52800 K (screw No. 93) - - - - -	8
6042 A	Tilting Feed Dog Holder Washer, for styles in Classes 52900, 53500, Styles 52700 A, 52700 B, 52700 G, 52700 H- - - - -	13
6905 H-12	Feed Dog, for No. 12 gauge Style 52700 A (screw No. 22528)- - - - -	4

LIST OF PARTS

Symbol to Order by	The figures in the last column refer only to the plates illustrating the parts and are not to be used in ordering. Refer to pink insert for prices.	Plate No.
6905 H-16	Feed Dog, for No. 16 gauge Style 52700 A (screw No. 22528) - - - - -	4
6920 A-12	Presser Foot, for No. 12 gauge Style 52700 A (clamp screw No. 91, yielding section, right, No. 6941 A, yielding section, left, No. 6942 A, yielding section spring No. 3040, yielding section spring screw No. 605) - - - - -	5
6920 A-16	Presser Foot, for No. 16 gauge Style 52700 A (clamp screw No. 91, yielding section, right, No. 6941 A, yielding section, left, No. 6942 A, yielding section spring No. 3040, yielding section spring screw No. 605) - - - - -	5
6920 L-12	Presser Foot, for making 1/2 inch belt loop on No. 12 gauge Style 52700 A (clamp screw No. 91) - - - - -	5
6920 L-16	Presser Foot, for making 1/2 inch belt loop on No. 16 gauge Style 52700 A (clamp screw No. 91) - - - - -	5
6941 A	Presser Foot Yielding Section, right, for Style 52700 A - - - - -	7
6942 A	Presser Foot Yielding Section, left, for Style 52700 A - - - - -	7
7205 A	Feed Dog, for No. 12 gauge Style 52700 B; also Nos. 8 and 12 gauge Style 52700 H (screw No. 22528) - - - - -	3
7947	Feed Crank Link Nut; also for No. 51245 - - - - -	12
8041	Presser Foot Yielding Section Spring Pin, for Style 52800 K - - - - -	7
8372 A	Looper Drive Ball Joint Locking Stud Washer; also for No. 52981 P - - - - -	13
9271	Knee Press Shaft Collar (screw No. 98) - - - - -	26
9471	Ruffler Adjusting Lever Spring, for Style 53500 C - - - - -	14
9660 B	Upper Rock Shaft Collar, for styles in Classes 52800, 52900, 53500 (screw No. 98)	12
9663	Screw, right, for cloth plate on styles in Class 53500 - - - - -	11
9937	Ruffler Indexed Segment Clamp Sleeve Stud Nut, for Style 53500 D - - - - -	12
10303 A	Edge Guide, for Style 52800 B (screw No. 25 C) - - - - -	21
11261 A	Tension Post, 1 7/8 inches long, for styles in Class 53500 - - - - -	15
11534	Presser Foot Yielding Section Spring, for Styles 52800 E, 52800 F, 52800 H (screw No. 605) - - - - -	7
11638 M	Main Shaft Oil Gauge Nut - - - - -	12

LIST OF PARTS

Symbol to Order by	The figures in the last column refer only to the plates illustrating the parts and are not to be used in ordering. Refer to pink insert for prices.	Plate No.
11663	Intermittent Strip Tension Operating Lever Spring- - - - -	14
12320 E-12	Presser Foot, for Style 52800 J (clamp screw No. 91, yielding section, right, No. 5041, yielding section, left, No. 5042, yielding section spring screw No. 605 A)	5
12538	Looper Rocker Ball Stud Nut - - - - -	12
12865	Presser Bar Stop Collar, for styles in Classes 52800, 52900 (screw No. 88) - - -	12
12934 A	Nut, for front spreader connecting rod ball stud on styles in Classes 52800, 52900; also for Nos. 52981 P, 53552 G- - - - -	12
12957 E	Edge Guide Spring Washer, for Styles 52700 F, 52800 G; also for No. 23405 M- -	13
12964 C	Needle Lever Link Pin Ball- - - - -	12
12982	Nut, for rear spreader connecting rod ball stud on styles in Classes 52800, 52900- -	12
12987 A	Nut, for needle lever stud oil cup; also for No. 15455 - - - - -	12
12988 A	Plug Screw, for opening in top of bed on styles in Classes 52700, 53500- - - - -	10
13120 F-8	Presser Foot Assembly, for No. 8 gauge Styles 52800 E, 52800 F; one each Nos. 13130 F-8, 73 A, 91, 605, 11534, 13130 A, 13130 B, 22799 B- - - - -	4
13130 A	Presser Foot Yielding Section, for Styles 52800 E, 52800 F- - - - -	6
13130 B	Presser Foot Shank, for Styles 52800 E, 52800 F (clamp screw No. 91)- - - - -	--
13130 F-8	Presser Foot Bottom, for No. 8 gauge Styles 52800 E, 52800 F (hinge screw No. 22799 B)	6
13153	Main Feed Dog Holder, for Styles 52700 F, 52800 B, 52800 D, 52800 E, 52800 F, 52800 G, 52800 H, 52800 J (screw No. 93)	8
15180 B	Edging Guide, for Style 52800 G (screw No. 187 A)- - - - -	16
15430 C	Needle Lever Connecting Rod Nut, left thread- - - - -	12
15430 D	Needle Lever Connecting Rod Nut, right thread; also for No. 52816- - - - -	12
15438 B	Supplementary Tension Disc, for spreader thread on styles in Classes 52800, 52900	13
15438 C	Supplementary Tension Spring- - - - -	14
15438 D	" " Stud- - - - -	10
15455	Lower Knife Holder Support Pin, for styles in Class 52900 (nut No. 12987 A)- - - - -	16
15465 F	Looper Rocker Cone (screw No. 88, nut No. 258 A)- - - - -	20

LIST OF PARTS

Symbol to Order by	The figures in the last column refer only to the plates illustrating the parts and are not to be used in ordering. Refer to pink insert for prices.	Plate No.
15480 C	Presser Foot Bottom Spring, for Styles 52700 G, 52700 H (stud No. 57 WD) - - - - -	7
15498 E	Grinder Head, for knife grinder No. 52998- - -	32
15498 G	Grinder Swinging Frame Pivot Pin, for knife grinder No. 52998- - - - -	24
15498 H	Grinder Swinging Frame Pivot Pin Friction Washer (screw No. 93 A)- - - - -	16
15498 J	Grinder Swinging Frame Adjusting Sleeve (clamp screw No. 136)- - - - -	32
15498 K	Grinder Swinging Frame Adjusting Thumbscrew	32
15498 L	Grinder Swinging Frame Stop Pin- - - - -	24
15498 P	Dust Guard, for knife grinder No. 52998 (screw No. 22570)- - - - -	32
15872 F	Lifter Lever Spring, for styles in Classes 52800, 52900 - - - - -	14
16194	Presser Foot Yielding Section Spring, for Style 52800 K (attaching screw No. 605, adjusting screw No. 605 A) - - - - -	7
20149 C	Knife Holder Clamp Plate Pin, for styles in Class 52900- - - - -	13
21102 B	Elastic Band Holder Supporting Rod, 18 inches long, .250 inch diameter, for Styles 52700 G, 52700 H; also Edging Spool Holder Supporting Rod for Style 52800 G- - - - -	42
21104 A	Thread Stand Base; also elastic band support base (screw No. 22509) - - - - -	42
21104 B-11	Thread Stand Rod, 11 inches long - - - - -	36
21104 B-20	Elastic Band Holder Supporting Rod, 20 inches long, for Styles 52700 G, 52700 H	36
21113 A	Thread Stand Wire Extension, 6 inches long, (set screw No. 22632 F-24) - - - - -	24
21113 B	Thread Stand Wire Coupling (screw No. 88)- - -	19
21130 A-3	Thread Stand Seat, 3 spools- - - - -	42
21130 A-4	" " " 4 spools- - - - -	42
21130 A-5	" " " 5 spools- - - - -	42
21130 A-6	" " " 6 spools- - - - -	42
	" " Seat Set Screw No. 69 FD	
21145	Cone, wood, for thread stand - - - - -	34
21169 D	Split Tube Border Holder Assembly, for Styles 52800 E, 52800 F, 52800 H, 52800 K; one each Nos. 88, 161, 21169 E, 21169 F (Specify component parts in ordering)- - -	42
21169 E	Split Tube Border Holder Disc- - - - -	42
21169 F	" " " " Base- - - - -	42
21177 A	Elastic Band Holder Spring Tension Collar, for Styles 52700 G, 52700 H (wing screw No. 22647 K-16)- - - - -	33

LIST OF PARTS

Symbol to Order by	The figures in the last column refer only to the plates illustrating the parts and are not to be used in ordering. Refer to pink insert for prices.	Plate No.
21178 A	Elastic Band Holder Disc, 11 inches diameter, for Styles 52700 G, 52700 H- - - - -	42
21182 AA	Intermittent Strip Tension Assembly, for Style 52800 E; one each Nos. 188 D, 1349, 11663, 21182 AB, 21182 AC, 21182 AD, 21182 AE, 21182 AF, 22504 B, 22561, 22760, 22845 E, 23439 C; two each Nos. 402, 21185 (attaching screws No. 22548)- - - - -	35
21182 AB	Intermittent Strip Tension Base (screw No. 22548) - - - - -	--
21182 AC	Intermittent Strip Tension Operating Lever (pivot stud No. 22504 B, stop screw No. 402) --	--
21182 AD	Intermittent Strip Tension Operating Arm (pivot screw No. 22760)- - - - -	--
21182 AE	Intermittent Strip Tension Adjustable Strip Guide (screw No. 22561)- - - - -	--
21182 AF	Intermittent Strip Tension Plate (locating screw No. 22845 E) - - - - -	--
21185	Intermittent Strip Tension Spring Nut- - - - -	12
21198 B	Split Tube Border Measuring Gauge Brace, for Style 52800 E (screw No. 94) - - - - -	--
21198 E	Split Tube Border Measuring Gauge Assembly, for Style 52800 E; one each Nos. 94, 21198 B, 21198 F, 21198 G, 21198 H; two each Nos. 21198 J, 22756 (screw No. 25 S) - - - - -	35
21198 F	Split Tube Border Measuring Gauge Base - - - - -	--
21198 G	Split Tube Border Measuring Gauge Slide, front (thumbscrew No. 22756, nut No. 21198 J)- - - - -	--
21198 H	Split Tube Border Measuring Gauge Slide, rear, (thumbscrew No. 22756, nut No. 21198 J)- - - - -	--
21198 J	Split Tube Border Measuring Gauge Slide Lock Nut- - - - -	12
21201	Screw Driver, 9/64 inch round blade, length overall 7 5/8 inches - - - - -	37
21202	Screw Driver, 7/32 inch round blade, length overall 11 1/4 inches- - - - -	37
21203	Screw Driver, 13/64 inch round blade, length overall 15 1/2 inches- - - - -	37
21204	Screw Driver, 9/32 inch round blade, length overall 15 inches- - - - -	37
21205 A	Screw Driver, 3/8 inch round blade, length overall 14 inches- - - - -	37
21207	Screw Driver, 7/64 inch round blade, length overall 2 1/2 inches - - - - -	34
21208	Screw Driver Set, three detachable blades- - - - -	37
21210	Looper Collar, .040 inch thick - - - - -	13
21210 A	" " .020 inch thick - - - - -	13
21211	" " .054 inch thick - - - - -	13

LIST OF PARTS

Symbol to Order by	The figures in the last column refer only to the plates illustrating the parts and are not to be used in ordering. Refer to pink insert for prices.	Plate No.
21215 C	Edging Spool Holder Assembly, for Style 52800 G; one each Nos. 752, 753, 21102 B; two each Nos. 81, 751 A, 21216, 21217, 21217 A, 22728 and five No. 188 D. (Specify component parts in ordering)- - -	41
21216	Edging Spool Holder Upright Rod, for Style 52800 G- - - - -	36
21217	Edging Spool Holder Support Base, for Style 52800 G- - - - -	40
21217 A	Edging Spool Holder Pin Support, for Style 52800 G; also elastic band holder pin support, for Styles 52700 F, 52700 G, 52700 H- - - - -	19
21225-3/16	Looper Adjusting Gauge, 3/16 inch measurement - - - - -	14
21225-7/32	Looper Adjusting Gauge, 7/32 inch measurement - - - - -	14
21225-1/4	Looper Adjusting Gauge, 1/4 inch measurement	14
21227 B-8	Spreader Gauge, for adjusting spreader on styles in Class 52900- - - - -	14
21227 C-8	Spreader Gauge, for adjusting spreader on No. 8 gauge two needle styles in Class 52800- - - - -	14
21227 C-12	Spreader Gauge, for adjusting spreader on No. 12 gauge two needle styles in Class 52800- - - - -	14
21227 C-14	Spreader Gauge, for adjusting spreader on No. 14 gauge three needle styles in Class 52800- - - - -	14
21227 C-16	Spreader Gauge, for adjusting spreader on No. 16 gauge three needle styles in Class 52800- - - - -	14
21227 R	Gauge, for synchronizing looper and needle motions on machines equipped with throat plates 2 1/4 inches long; component parts are shipped in leather case- - - - -	29
21227 V	Gauge, for setting height of spreader and presser foot on styles in Classes 52800 and 52900- - - - -	14
21227 AC	Gauge, for synchronizing looper and needle motions on machines equipped with throat plates 3 1/8 inches long; component parts are shipped in leather case- - - - -	29

LIST OF PARTS

Symbol to Order by	The figures in the last column refer only to the plates illustrating the parts and are not to be used in ordering. Refer to pink insert for prices.	Plate No.
21227 HH	Porcelain Eyelet Replacement Tool Set, for assembling 1/16 inch internal diameter porcelain eyelets No. 668-7 and aluminum ferrules No. 668-12 in tension thread eyelet assembly.	
21231 D	Thread Meter, for recording the consumption of thread in 1/10 yards as it passes into the sewing machine- - - - -	29
21233 D	Light Fixture Assembly, including bulb, table mounting, for machines driven by "Electro Drive" - - - - -	39
21233 N	Connector, with BX cable for D.C. "Electro Drives" - - - - -	--
21233 P	Connector, with BX cable for single and three phase A.C. "Electro Drives" - - - - -	--
21236	Belt Plier, for 3/8 inch and smaller round belting - - - - -	40
21260	Emery Cord, 3/64 inch diameter, grade No. 120, fifty yard spool - - - - -	--
21260 A	Emery Cord, 3/64 inch diameter, grade No. 150, fifty yard spool - - - - -	--
21260 B	" " 1/32 inch diameter, grade No. 180, fifty yard spool - - - - -	--
21260 C	" " .025 inch diameter, grade No. 200, fifty yard spool - - - - -	--
21260 D	" Tape, 3/32 inch wide, grade No. 180, fifty yard spool - - - - -	--
21260 E	" Cord, .018 inch diameter, grade No. 200, fifty yard spool - - - - -	--
21261	Leather Belt, flat, 1 inch wide, 63 inches long, includes belt fastener No. 21350 - - - - -	--
21262	Leather Belt, round, 9/32 inch diameter, 44 inches long, includes wire belt hook No. 21351 - - - - -	--
21262 G-340	"V" Belt, No. 2 size, 34 inches outside circumference - - - - -	40
21262 G-350	" " 35 inches outside circumference - - - - -	40
21262 G-370	" " 37 inches outside circumference - - - - -	40
21262 G-380	" " 38 inches outside circumference - - - - -	40
21300 C-5 3/4	Carriage Bolt, countersunk head, 3/8 x 5 3/4 inches, for table tops- - - - -	--
21350	Belt Fastener, malleable iron, for 1 inch flat belt - - - - -	17
21351	Belt Hook, wire, for 9/32 inch round belt - - - - -	17
21355	Chair Leg Extension, 4 inches long- - - - -	34
21371 Q	Table Drawer- - - - -	--



LIST OF PARTS

Symbol to Order by	The figures in the last column refer only to the plates illustrating the parts and are not to be used in ordering. Refer to pink insert for prices.	Plate No.
21371 BR-42	Table Top, 42" x 16" x 1 3/4", prepared completely for group semisubmerged isolated installation of Styles 52700 A, 52700 B, 52700 G, 52700 H, 53500 C, 53500 D - - - - -	--
21371 BR-48	Table Top, 48" long - - - - -	--
21371 BR-54	" " 54" long - - - - -	--
21371 BR-60	" " 60" long - - - - -	--
21371 BT-48	Blank Table Top, 48" long - - - - -	--
21371 BT-54	" " 54" long - - - - -	--
21371 BT-60	" " 60" long - - - - -	--
21371 CT	Cap Nut, for isolated insulator on line assembly individual power table - - - - -	12
21371 CU-42	Table Top, 42" x 16" x 1 3/4", includes base plate No. 21680 AK, for semisubmerged isolated installation of styles in Classes 52800, 52900, Style 52700 F - - - - -	--
21371 CU-48	Table Top, 48" long - - - - -	--
21371 CU-54	" " 54" long - - - - -	--
21371 CU-60	" " 60" long - - - - -	--
21371 CX-42	Table Top, 42" x 16" x 1 3/4", includes base plate No. 21680 AK, for nonsubmerged isolated installation of styles in Classes 52700, 52800, 52900 - - - - -	--
21371 CX-48	Table Top, 48" long - - - - -	--
21371 CX-54	" " 54" long - - - - -	--
21371 CX-60	" " 60" long - - - - -	--
21371 FQ-42	" " 42" x 16" x 1 3/4" for line assembly nonsubmerged isolated installations - - - - -	--
21371 FQ-48	" " 48" long - - - - -	--
21371 FQ-54	" " 54" long - - - - -	--
21371 FQ-60	" " 60" long - - - - -	--
21371 FR-42	Table Top 42" x 16" x 1 3/4", for line assembly semisubmerged isolated installations of Styles 52700 A, 52700 B, 52700 G, 52700 H, 53500 C, 53500 D - - - - -	--
21371 FR-48	Table Top, 48" long - - - - -	--
21371 FR-54	" " 54" long - - - - -	--
21371 FR-60	" " 60" long - - - - -	--
21373 A-5	General Utility Individual Power Table, for nonsubmerged installations of machines equipped with "Electro Drive", 1/2 H.P. A.C. 1 phase, 60 cycles, 105-115 volts, 3400 R.P.M. - - - - -	--
21373 A-5 D	For 1/2 H.P., A.C., 1 phase, 60 cycles, 220 volts, 3450 R.P.M. - - - - -	--
21373 A-7	For 1/2 H.P., A.C., 3 phase, 60 cycles, 105-115 volts, 3500 R.P.M. - - - - -	--

LIST OF PARTS

Symbol to Order by	The figures in the last column refer only to the plates illustrating the parts and are not to be used in ordering. Refer to pink insert for prices.	Plate No.
21373 A-7 B	For 1/2 H.P., A.C., 3 phase, 60 cycles, 210-230 volts, 3500 R.P.M. - - - - -	--
21373 A-7 D	For 1/2 H.P., A.C., 3 phase, 60 cycles, 440 volts, 3500 R.P.M. - - - - -	--
21373 A-8	For 1/2 H.P., D.C., 105-115 volts, 3000 R.P.M. - - - - -	--
21373 A-8 A	For 1/2 H.P., D.C., 210-230 volts, 3000 R.P.M. - - - - -	--
21375 AH	Pulley Guard, machine mounting (screw No. (93) - - - - -	40
21377 AK	Tray, 4 1/32" high, hinged body and front section, for nonsubmerged isolated installations of Styles 52700 A, 52700 B, 52700 G, 52700 H - - - - -	43
21377 AL	Tray, 2 9/32" high, hinged body and front section, for semisubmerged isolated installations of Styles 52700 A, 52700 B, 52700 G, 52700 H - - - - -	43
21377 AN	Tray, 2 9/32" high, hinged body, for semisubmerged isolated installations of styles in Class 53500- - - - -	43
21377 AR	Tray, 2 15/32 inches high, hinged body, for semisubmerged isolated installation of styles in Class 52900 - - - - -	43
21388	Wrench, single end, 3/8 inch opening - - -	34
21388 N	" double end, 3/16 and 5/16 inch openings - - - - -	34
21388 R	" double end, 3/8 and 1/2 inch openings - - - - -	34
21388 W	" double end, curved, 9/32 inch opening- - - - -	34
21388 X	" for main shaft bearing housing - -	42
21388 Z	Wrench, for setting needle lever stud with respect to oil groove, Stud is set correctly when the pin hole nearest the periphery is up and a line drawn between the two pin holes is 45 degrees to the right of the vertical- - - - -	34
21388 AE	Socket Wrench Assembly, for 9/32 inch and 3/8 inch hexagonal nuts, for looper lever ball stud locking stud and tilting feed mechanism - - - - -	34
21394	Utility Grinder, including emery wheel, 5 inches diameter, 1/4 inch face, round belt drive, recommended speed 3000 R.P.M. - - - - -	--
21394 G	Emery Wheel, 5 inches diameter, 1/4 inch face, 3/8 inch hole, grade "M" emery 60	--

LIST OF PARTS

Symbol to Order by	The figures in the last column refer only to the plates illustrating the parts and are not to be used in ordering. Refer to pink insert for prices.	Plate No.
21394 H	Emery Wheel, 5 inches diameter, 1/2 inch face, 3/8 inch hole, grade "M" emery 60 - - - -	--
21394 K	Utility Grinder, including emery wheel, 5 inches diameter, 1/2 inch face, round belt drive, recommended speed 3000 R.P.M. - - - -	--
21629	Screw, for chip guard tension spring on styles in Class 52900 - - - - -	9
21657-3	Tension Release Disc Separator, for Styles 52700 A, 52700 B, 52700 H, 52800 E, 52800 F, 52800 G, 52800 H, 52800 J- - - - -	22
21657-4	Tension Release Disc Separator, for styles in Class 53500, Styles 52700 F, 52700 G, 52800 B, 52800 D, 52800 K - - - - -	22
21657-5	Tension Release Disc Separator, for styles in Class 52900 - - - - -	22
21657 A	Tension Release Rock Shaft, for styles in Classes 52700, 52800, 52900 - - - - -	23
21657 B	Tension Release Rock Shaft Connection (clamp screw No. 22585)- - - - -	19
21657 C	Tension Release Rock Shaft Lever, for styles in Classes 52700, 52800, 52900 (clamp screw No. 22596, stud No. 22594)- - - - -	22
21657 D	Tension Release Rock Shaft Lever Link, for styles in Class 52700 (stud No. 22515)- - - - -	22
21657 E	Tension Release Disc Separator Washer; also for No. 53541 H - - - - -	13
21657 F	Tension Release Rock Shaft, for styles in Class 53500 - - - - -	23
21657 G	Tension Release Rock Shaft Lever, for styles in Class 53500 (clamp screw No. 22596, stud No. 22594)- - - - -	22
21657 H	Tension Release Rock Shaft Connection Link, for styles in Class 53500 (stud No. 22515) - - - - -	22
21657 J	Tension Release Rock Shaft Lever Link, for styles in Classes 52800, 52900 (stud No. 22515)- - - - -	22
21661	Knee Press Shaft, for Style 53500 C - - - - -	40
21662	" " Shaft Hanger - - - - -	40
21664	" " Plate (set screw No. 69 FD)- - - - -	40
21665	" " " Rod Connection (screw No. 69 FD) - - - - -	40
21677	" " Bell Crank Arm - - - - -	40
21679	" " Pitman Lever - - - - -	40
21680 AK	Base Plate, for nonsubmerged and semisubmerged installations on six isolators - - - - -	41

LIST OF PARTS

Symbol to Order by	The figures in the last column refer only to the plates illustrating the parts and are not to be used in ordering. Refer to pink insert for prices.	Plate No.
21691	Knee Press Assembly, for Style 53500 C; also for operating intermittent strip tension on Style 52800 E; one each Nos. 421 C-10, 660-128, 21661, 21662, 21664, 21677, 21679, 28505; two each Nos. 9271 21665. (Specify component parts in ordering) - - - -	
21697 C	Belt Take-up Assembly, for "V" belt on "Electro Drive" installations- - - - -	40
21698-2	Vibration Insulator, two inches long, for tables - - - - -	39
21698-4	Vibration Insulator, four inches long- - - - -	33
21698-5	" " five inches long- - - - -	33
21698-6	" " six inches long - - - - -	33
Note: Special lengths will be furnished on request. Part of the table leg is shown in the illustration for clarity		
21745 B	Wing Nut, for ruffler indexed segment clamp sleeve stud on Style 53500 D - - - - -	12
21745 D	Thumbscrew, for ruffler adjusting lever stop on Style 53500 C - - - - -	11
22504 B	Pivot Stud, for intermittent strip tension operating lever on Style 52800 E - - - - -	9
22509	Set Screw, square head, cup point, 5/16 inch diameter, 18 threads per inch, 1/2 inch long, for thread stand base- - - - -	11
22513	Screw, for presser bar connection guide plate	9
22514	" 7/16 inch long, for cloth plate attachments - - - - -	10
22515	Stud, for tension release rock shaft lever link - - - - -	10
22516	Screw, for feed rocker segment slot plate on styles in Class 52800, Style 52700 F; also for No. 52971 A- - - - -	10
22517 C	Screw, 5/16 inch long, for supplementary tension stud on styles in Classes 52800, 52900	10
22519	Set Screw, hexagonal head, for needle lever ball stud- - - - -	9
22521	Screw, plus size, for cloth plate (tap No. V118)- - - - -	10
22525 A	Screw, for supplementary face place on styles in Class 53500 - - - - -	9
22528	Screw, for feed dog on styles in Classes 52900, 53500, Styles 52700 A, 52700 B, 52700 G, 52700 H; also for Nos. 23306 U, 23306 X, 52857 - - - - -	10
22539 C	Plug Screw, for cloth plate on Styles 52700 A, 52700 B, 52700 G, 52700 H- - - - -	11
22541	Clamp Screw, for ruffler operating lever on styles in Class 53500- - - - -	11

LIST OF PARTS

Symbol to Order by	The figures in the last column refer only to the plates illustrating the parts and are not to be used in ordering. Refer to pink insert for prices.	Plate No.
22548	Screw, lower, for auxiliary cloth plate on styles in Class 53500; also for Nos. 21182 AA, 21182 AB, 23439 B, 53541- - - - -	10
22559 A	Bearing Screw, lower, for looper drive connection- - - - -	10
22559 B	Bearing Screw, upper, for looper drive connection- - - - -	11
22559 C	Bearing Screw, for ruffler eccentric connection on styles in Class 53500- - - - -	11
22560	Screw, for needle lever link pin spring; also for No. 52842 - - - - -	9
22560 B	Set Screw, headless, for feed bars; also for No. 39143 G - - - - -	9
22561	Screw, for cloth plate cover locating spring on styles in Class 52900; also for Nos. 21182 AE, 23133 L, 23133 M, 23306 Q, 52730 K, 52730 L, 52830 B, K53464, 53530 F - - - - -	9
22562	Screw, for folder swinging arm latch on styles in Class 52800, Style 52700 F - - - - -	9
22566 A	Stud, for lifter lever- - - - -	11
22567	Screw, for folder support bracket on Styles 52800 E 52800 F, 52800 H, 52800 K - - - - -	10
22568	Screw, for lower knife holder block on styles in Class 52900; also for No. 23306 A- - - - -	10
22569	Screw, for feed crank link; also for Nos. 29132 M, 51245, 53554 D - - - - -	11
22570	Screw, fillister head, for throat plates; also for No. 15498 P - - - - -	9
22571	Plug Screw, for frame thread eyelet hole on Styles 52700 A, 52700 B, 53500 D- - - - -	10
22571 A	Plug Screw, for spring pressed felt wick on main shaft bearings and main shaft oil reservoir - - - - -	10
22574	Screw, for throat plate support on styles in Classes 52800, 52900, Style 52700 F - - - - -	10
22580	Set Screw, for needles on Styles 52700 A, 52700 B, 52700 H, 53500 C, 53500 D; also for Nos. 29132 M, 39143 G, 52723 A, 52823, 52923	9
22585	Clamp Screw, for tension release rock shaft connection; also for Nos. 52894 J, 52943 A, 52943 B, 52998 B- - - - -	9
22585 B	Screw, for needle guard on styles in Classes 52900, 53500- - - - -	10
22586	Plug Screw, for ruffler eccentric bearing on styles in Class 53500 - - - - -	9
22586 B	Plug Screw, for sight feed oiler hole on Styles 52700 A, 52700 B, 52700 G, 52700 H- - - - -	9
22587	Screw, for spreader eccentric bearing on styles in Classes 52800, 52900 - - - - -	11

LIST OF PARTS

Symbol to Order by	The figures in the last column refer only to the plates illustrating the parts and are not to be used in ordering. Refer to pink insert for prices.	Plate No.
22588 A	Screw, for lower knife clamp plate on styles in Class 52900- - - - -	10
22591	Set Screw, for knife grinder swinging frame on knife grinder No. 52998 - - - - -	9
22593	Screw, for main feed dog on styles in Class 52800, Style 52700 F; also for Nos. 39237 D, 51104 D, 51158 D, 52730 B, 52845, 52845 A - - - - -	9
22594	Stud, for tension release rock shaft lever	10
22596	Clamp Screw, for tension release rock shaft lever; also for No. 53541 H- - - - -	11
22597	Spot Screw, for pulleys- - - - -	10
22597 A	Set Screw, for pulleys; also for No. 51242 A	10
22599	Pivot Screw, for chip guard on styles in Class 52900- - - - -	9
22632 F-24	Screw, square head, cup point, 3/16 inch diameter, 3/8 inch long, 24 threads per inch, for thread stand wires - - - - -	9
22647 K-16	Wing Screw, 1/4 inch long, for elastic band holder spring tension collar on Styles 52700 G, 52700 H - - - - -	10
22703	Thumbscrew, for regulating elastic band tension on Styles 52700 F, 52700 G, 52700 H, 52800 G- - - - -	10
22711	Screw, for looper thread guard on styles in Class 53500; also for No. 243- - - - -	9
22716	Screw, for looper drive eccentric oil disc; also for No. K54742- - - - -	9
22716 A	Screw, for looper drive eccentric oil disc washer; also for No. 52816 F - - - - -	9
22726	Pivot Screw, for hemmer swinging arm on Style 52700 B- - - - -	10
22726 A	Screw, for cloth plate cover spring on styles in Class 53500, Styles 52700 A, 52700 B, 52700 G, 52700 H- - - - -	9
22728	Thumbscrew, for edging spool holder pin on Styles 52700 F, 52700 G, 52700 H, 52800 G	11
22730	Screw, for cloth plate on styles in Class 53500; also for Nos. 51758 A, 53595 E- - -	10
22733 A	Plug Screw, for hole in top of bed on styles in Classes 52800, 52900, Style 52700 F - -	10
22735	Pivot Screw, for edge guide on Styles 52700 F, 52800 G - - - - -	10
22738	Stop Screw, for presser foot yielding section on Style 52700 F- - - - -	9
22743	Screw, for differential feed bar guide on styles in Class 52800, Style 52700 F - - -	9
22747	Screw, for spreader connecting rod ball joint stud fork on styles in Classes 52800, 52900 - - - - -	9

LIST OF PARTS

Symbol to Order by	The figures in the last column refer only to the plates illustrating the parts and are not to be used in ordering. Refer to pink insert for prices.	Plate No.
22756	Thumbscrew, for split tube border measuring gauge slide on Style 52800 E - - - - -	10
22760	Pivot Screw, for intermittent strip tension operating arm on Style 52800 E - - - - -	9
22764	Spot Screw, for ruffler adjusting segment lever clamping plate on Style 53500 C- - - -	9
22764 A	Spot Screw, for take-up on styles in Class 53500- - - - -	9
22768	Screw, for needle bar and needle lever thread eyelets; also for Nos. 51134, 51134 A, 51236 B, 52958, 53548 G, K54900- - - - -	9
22769	Screw, for crank chamber oil tube clamp- - - -	10
22788	Screw, for upper knife holder rocker arm bracket on styles in Class 52900 - - - - -	11
22795	Stitch Regulating Screw- - - - -	10
22799 A	Hinge Screw, length overall 33/64 inch, diameter .088 inch, for presser foot bottom on No. 16-8 gauge Style 52900 B - - - - -	10
22799 B	Hinge Screw, length overall 19/32 inch, diameter .088 inch, for presser foot bottom on Styles 52700 F, 52800 E, 52800 F, 52800 H, 53500 C, 53500 D - - - - -	10
22799 F	Hinge Screw, length overall 5/16 inch, for presser foot bottom on No. 5-8 gauge styles in Class 52900; also for No. 53553 R - - - -	9
22799 N	Screw, for cloth plate slide No. 51202; also for Nos. 52802 A, 52971 H- - - - -	9
22801	Stop Screw, for stitch regulating screw; also for Nos. 51225, 52925- - - - -	9
22811	Clamp Screw, for spreader rock shaft adjusting segment lever on styles in Classes 52800, 52900- - - - -	11
22812	Screw, for knife positioning lever on knife grinder No. 52998 (washer No. 39198 A) - - -	10
22813	Screw, headless, for lifter treadle pin- - - -	9
22823 A	Screw, 11/16 inch long, hexagonal head, for attaching machine to base plate No. 21680 AK	11
22823 B	Screw, 1 9/32 inches long, hexagonal head, for attaching machine to base plate No. 21680 AK	11
22829	Locking Screw, for looper rocker cone nut- - -	9
22830	Screw, for knife holder guide collar on styles in Class 52900 - - - - -	9
22834	Screw, for regulating needle guards on styles in Classes 52900, 53500- - - - -	9
22837	Thumbscrew, for face plate - - - - -	10
22839	Screw, fillister head, for throat plate support on Styles 52700 A, 52700 B, 52700 G, 52700 H- - - - -	10

LIST OF PARTS

Symbol to Order by	The figures in the last column refer only to the plates illustrating the parts and are not to be used in ordering. Refer to pink insert for prices.	Plate No.
22840	Adapter Screw, for frame needle thread eyelet on styles in Classes 52800, 52900, 53500, Styles 52700 F, 52700 G - - - - -	10
22840 A	Screw, for regulating presser foot bottom on Styles 52700 F, 53500 C, 53500 D- - - - -	10
22841 B	Cloth Plate Supporting Stud, for styles in Classes 52800, 52900, Style 52700 F - - - - -	33
22841 C	Cloth Plate Supporting Stud, for styles in Class 53500 - - - - -	33
22845 A	Stop Screw, for ruffler indexed segment on Style 53500 D - - - - -	9
22845 B	Hinge Screw, for presser foot bottom front section on styles in Class 53500 - - - - -	9
22845 E	Screw, for intermittent strip tension plate on Style 52800 E - - - - -	9
22848	Screw, for end cover hinge bracket on styles in Classes 52800, 52900, Style 52700 F; also for Nos. 539, 51491 A, 51758, 51958 B, 52957- - -	10
22849	Screw, right, for upper crank chamber oil reservoir- - - - -	10
22863	Adjusting Screw, for feed dog holder on styles in Classes 52900, 53500, Styles 52700 A, 52700 B, 52700 G, 52700 H - - - - -	9
22864	Needle Lever Link Pin Clamp Screw (nut No. 51250 C)- - - - -	11
22865	Stud, 1 7/16 inches long, for left rock shaft bearing on styles in Classes 52800, 52900, 53500 - - - - -	11
22865 A	Stud, 1 7/16 inches long, for right rock shaft bearing - - - - -	11
22867	Screw, for ruffler adjusting segment lever sliding block on Style 53500 C (nut No. 12934 A)- - - - -	10
22872	Screw, for spreader adjusting segment lever and rock shaft cover on styles in Classes 52800, 52900; also for No. 52855 - - - - -	10
23133 L	Edge Guide, 3/64 inch capacity for body of garment on Style 52800 F (screw No. 22561) - - -	21
23133 M	Edge Guide, 3/32 inch capacity for body of garment on Styles 52800 H, 52800 K (screw No. 22561)- - - - -	21
23144 A	Spring Washer, for folder swinging arm on styles in Class 52800, Style 52700 F- - - - -	13
23195	Edge Guide, for Style 52800 D (screw No. 187 A)	16
23254	Folder, for making 11/32 inch belt loops on No. 16 gauge Style 52700 A, uses strip 7/8 inch wide- - - - -	21
23254 C	Folder, for making 9/32 inch belt loops on No. 12 gauge Style 52700 A, uses strip 11/16 inch wide- - - - -	21



LIST OF PARTS

Symbol to Order by	The figures in the last column refer only to the plates illustrating the parts and are not to be used in ordering. Refer to pink insert for prices.	Plate No.
23254 K-1/2	Folder, for making 1/2 inch belt loops on Style 52700 A, uses strip 1 inch wide - - Folder Screw No. 25 C	21
23279 D	Folder Threader - - - - -	22
23306 A	Elastic Guide, for Styles 52700 F, 52700 G, 52700 H (screw No. 22568) - - - - -	22
23306 L	Elastic Guide and Tension Support Assembly, for Styles 52700 G, 52700 H; one each Nos. 25 CC, 22568, 23306 A, 23306 M (screw No. 90) - - - - -	35
23306 M	Elastic Guide and Tension Support, for Styles 52700 F, 52700 G, 52700 H; also Edging Guide and Tension Support for Style 52800 G (screw No. 90) - - - - -	22
23306 Q	Edging Guide, for Style 52800 G (screw No. 22561) - - - - -	22
23306 R	Edging Guide and Tension Assembly, for Style 52800 G (adjustable guide No. 15180 B, adjustable guide screw No. 187 A, tension regulating screw No. 22703, tension regulating screw lock nut No. 907, set screw No. 25 CC) - - - - -	35
23306 S	Elastic Guide and Tension Assembly, for Style 52700 H (adjustable guide No. 23306 T, adjustable guide screw No. 25 B, tension regulating screw No. 22703, tension regulating screw lock nut No. 907, set screw No. 25 CC) - - - - -	35
23306 T	Adjustable Elastic Guide, for Style 52700 H (screw No. 25 B) - - - - -	22
23306 U	Elastic Guide and Tension Assembly Brace, for Style 52700 H (screw No. 22528) - - -	22
23306 V	Elastic Guide and Tension Assembly, for Style 52700 G (adjustable guide No. 23306 W, adjustable guide screw No. 25 B, tension regulating screw No. 22703, tension regulating screw lock nut No. 907, set screw No. 25 CC) - - - - -	35
23306 W	Adjustable Elastic Guide, for Style 52700 G (screw No. 25 B) - - - - -	22
23306 X	Elastic Guide and Tension Assembly Brace, for Style 52700 G (screw No. 22528) - - -	22
23405 M	Folder, swing out type, for turning edge of garment upwardly, 1/8 inch fold, 1/16 inch capacity on Styles 52700 G, 52700 H (pivot screw No. 22726, spring washer No. 12957 E, attaching screw No. 25 C) - - - -	21

LIST OF PARTS

Symbol to Order by	The figures in the last column refer only to the plates illustrating the parts and are not to be used in ordering. Refer to pink insert for prices.	Plate No.
23406 K-1/2	Folder, 3/64 inch strip capacity, for attaching split tube borders on Style 52800 F, 1/2 inch finish, strip cut 1 inch wide-	35
23406 K-1	Folder, for 1 inch finish, strip cut 2 inches wide-	35
23406 L-1/2	Folder, 1/32 inch strip capacity, for attaching split tube borders on Style 52800 E, 1/2 inch finish, strip cut 1 inch wide-	35
23406 L-5/8	Folder, for 5/8 inch finish, strip cut 1 1/4 inches wide-	35
23406 L-3/4	Folder, for 3/4 inch finish, strip cut 1 1/2 inches wide-	35
23406 M-5/8	Folder, 3/64 inch strip capacity, for attaching split tube borders on Style 52800 F, 5/8 inch finish, strip cut 1 1/4 inches wide-	35
23406 M-3/4	Folder, for 3/4 inch finish, strip cut 1 1/2 inches wide-	35
23425 U	Folder Attaching Screw No. 25 CC Washer Plate, for cloth plate attachments on styles in Class 53500 -	21
23425 V	Washer Plate, for folder support on Styles 52800 E, 52800 F, 52800 H, 52800 K -	21
23432	Folder Clamp, for Styles 52800 E, 52800 F, 52800 H, 52800 K (screw No. 25 S)-	22
23439 B	Pin Tension Assembly, for Styles 52800 F, 52800 H, 52800 K (attaching screw No. 22548) -	35
23439 C	Pin Tension Adjustable Pin, for Styles 52800 E, 52800 F, 52800 H, 52800 K (thumbscrew No. 188 D) -	35
23440	Hemmer Assembly, for hemming bath robes on Style 52700 B; one each Nos. 22726, 23440 A, 23440 B, 23440 C, 23440 D; two No. 187 A (attaching screw No. 25 C). (Specify component parts in ordering)-	--
23440 A	Hemmer Base (attaching screw No. 25 C) -	21
23440 B	Hemmer Swinging Arm (pivot screw No. 22726)	21
23440 C	Hemmer Blade, adjustable (screw No. 187 A)	21
23440 D	Hemmer Scroll Guide (screw No. 25 C) -	21
23442 A	Folder, upper, for attaching ruffles to lace curtains on styles in Class 53500 (screw No. 90) -	21
23443 A	Folder, lower, for attaching ruffles to lace curtains on styles in Class 53500 (screw No. 25 C) -	21
28505	Knee Press Pitman Lever Spring, for Styles 52800 E, 53500 C -	33

LIST OF PARTS

Symbol to Order by	The figures in the last column refer only to the plates illustrating the parts and are not to be used in ordering. Refer to pink insert for prices.	Plate No.
28604	Transmitter Lubricant, No. 3 Arctic Cup Grease, 5 lb. package - - - - -	--
28606-1/2	Powdered Oil Stone, 1/2 lb. package - - - - -	--
28606-1	" " " 1 lb. package - - - - -	--
28705	"Electro Drive", 1/2 H.P., A.C., 1 phase, 60 cycles, 105-115 volts, 3400 R.P.M. - - - - -	--
28705 D	"Electro Drive", 1/2 H.P., A.C., 1 phase, 60 cycles, 220 volts, 3450 R.P.M. - - - - -	--
28707 B	"Electro Drive", 1/2 H.P., A.C., 3 phase, 60 cycles, 210-230 volts, 3500 R.P.M. - - - - -	--
28707 D	"Electro Drive", 1/2 H.P., A.C., 3 phase, 60 cycles, 440 volts, 3500 R.P.M. - - - - -	--
28708	"Electro Drive", 1/2 H.P., D.C., 105-115 volts, 3000 R.P.M. - - - - -	--
28708 A	"Electro Drive", 1/2 H.P., D.C., 210-230 volts, 3000 R.P.M. - - - - -	--
29066 F	Needle Lever Connecting Rod Upper Bearing Assembly; one each Nos. 51216 A, 51243 B lapped together - - - - -	27
‡29105 K	Looper Drive Eccentric Assembly, internal and external oiling, includes eccentric No. 52840 G, for styles in Classes 52700, 52800, 52900 (set screw No. 98, spot screw No. 96, bearing screw, upper, No. 22559 B, bearing screw, lower, No. 22559 A) - - - - -	27
‡29105 L	Looper Drive Eccentric Assembly, internal and external oiling, includes eccentric No. 51243 P, for styles in Class 53500 (set screw No. 98, spot screw No. 96, bearing screw, upper, No. 22559 B, bearing screw, lower, No. 22559 A) - - - - -	27
‡29114 B	Ruffler Eccentric Assembly, for styles in Class 53500; includes eccentric No. 53551 A (spot screw No. 81, set screw No. 95, bearing screw No. 22559 C) - - - - -	27
‡29126 AK	Spreader Eccentric Assembly, for styles in Classes 52800, 52900, includes eccentric No. 52851 B (set screw No. 95, bearing screw No. 22587) - - - - -	27
‡29132 M	Knife Eccentric Assembly, for styles in Class 52900, includes eccentric No. 52975 (set screw No. 22580, spot screw No. 96, shim No. 52974 G, clamp screw No. 22569) - - - - -	27

LIST OF PARTS

Symbol to Order by	The figures in the last column refer only to the plate illustrating the parts and are not to be used in ordering. Refer to pink insert for prices.	Plate No.
29192	Looper Rocker Assembly, for styles in Classes 52700, 52800; one each Nos. 51213, 15465 F, 51745 lapped together; also one each Nos. 258 A, 22829 and two No. 88- - - - -	27
29192 F	Looper Rocker Assembly, for styles in Class 53500; one each Nos. 53513, 15465 F, 51745 lapped together; also one each Nos. 258 A, 22829 and two No. 88 - - - - -	27
29192 G	Looper Rocker Assembly, for styles in Class 52900; one each Nos. 52913, 15465 F, 51745 lapped together; also one each Nos. 258 A, 22829 and two No. 88 - - - - -	27
29264 S-16	Needle Bar Assembly, for No. 16 gauge Styles 52700 G, 52800 B, 52800 D, 52800 K	--
29264 S-5-8	Needle Bar Assembly, for No. 5-8 gauge styles in Class 52900; one each Nos. 52917-8, 52918-5-8- - - - -	--
29402	Lifter Treadle Assembly; one each Nos. 422, 423, 424, 22813 - - - - -	39
29435 C	Cloth Plate Cover and Chip Guard Assembly, for styles in Class 52900; one each Nos. 52978 A-8, 356, 8372 A, 12934 A, 22561, 22599, 52978 N, 52981 A, 52981 G, 52981 P	31
35149 C	Looper Connecting Rod Ball Stud Washer, for styles in Class 53500 - - - - -	13
35582 B	Supplementary Tension Disc Thread Guide, for spreader thread on styles in Classes 52800, 52900- - - - -	15
35731 A	Presser Bar Connection Guide Plate (screw No. 22513)- - - - -	18
35733 B	Presser Spring Regulating Screw Lock Nut- -	12
35741 A	Looper Connecting Rod, for styles in Classes 52700, 52800, 52900 (nut, right thread, No. 18, nut, left thread No. 269)	24
35755 E	Ruffler Eccentric Connecting Rod Ball Stud Washer, for Style 53500 D - - - - -	13
35759	Needle Bar Connection - - - - -	20
35766	Screw, for lower knife holder block on styles in Class 52900; also for No. 53552 C - - - - -	11
35768 A	Screw, left, for crank chamber oil reservoir; also for No. 52887- - - - -	9
35772 D	Stop Pin, for edge guide on Styles 52700 F, 52800 G - - - - -	13
35788 B	Crank Chamber Oil Reservoir Cover (screw No. 605)- - - - -	29
35833 A	Presser Spring Regulating Stud (nut No. 258 A)- - - - -	19

LIST OF PARTS

Symbol to Order by	The figures in the last column refer only to the plates illustrating the parts and are not to be used in ordering. Refer to pink insert for prices.	Plate No.
35833 C	Presser Spring Plate - - - - -	26
39132 V	End Cover Hinge Pin, for styles in Classes 52800, 52900, Style 52700 F- - - - -	13
39135	Feed Bar Shaft, 2 inches long (set screw No. 77)- - - - -	24
39142 Q	Ruffler Blade Holder Pin, for styles in Class 53500 (clamp screw No. 75, clamp screw nut No. 907) - - - - -	13
39143 G	Knife Holder Rocker Arm Shaft (plug screw No. 22580, set screw No. 22560 B)- - - - -	24
39193	Crank Chamber Oil Reservoir Sight Gauge Assembly; one each Nos. 660-92, 660-93, 666-49, 39193 A, 39193 B - - - - -	17
39193 A	Crank Chamber Oil Reservoir Sight Gauge Glass Tube Cover - - - - -	17
39193 B	Crank Chamber Oil Reservoir Sight Gauge Base	--
39198 D	Knife Positioning Lever Spring Washer, for knife grinder No. 52998- - - - -	13
39236 A	Differential Feed Regulating Stud Washer, for styles in Class 52800, Style 52700 F; also for Nos. 51225, 52925- - - - -	13
39236 B	Differential Feed Regulating Stud (nut No. 907) - - - - -	13
39236 C	Differential Feed Regulating Stud Stop - - - - -	12
39236 U	Differential Feed Driving Link - - - - -	20
39236 V	Differential Feed Control Rear Lever Link Bushing- - - - -	16
39237	Differential Feed Bar Guide (screw No. 22743)	20
39237 D	Differential Feed Bar Guide Plate (screw No. 22593) - - - - -	18
39237 G	Differential Feed Bar Bushing- - - - -	16
41043 D	Ruffler Eccentric Connecting Rod Ball Joint Assembly, for Style 53500 D (screw No. 97 A)	20
41071 G	Nut, for oil tube brace on styles in Classes 52700, 52800, 52900- - - - -	12
41076 D	Needle Bar Thread Eyelet, for spreader thread on styles in Classes 52800, 52900 (screw No. 73 A)- - - - -	15
41255 B	Spreader Rock Shaft Connecting Rod Ball Joint Stud Fork, for styles in Classes 52800, 52900 (screw No. 22747)- - - - -	20
43266	Spreader Thread Tension Post Nut, for styles in Classes 52800, 52900; also upper needle thread tension post nut for Styles 52700 F, 52700 G, 52800 B, 52800 D, 52800 K - - - - -	12
43281 K	Folder Swinging Arm Spring, for styles in Class 52800, Style 52700 F (screw No. 90)- -	14

‡See Page 10

LIST OF PARTS

Symbol to Order by	The figures in the last column refer only to the plates illustrating the parts and are not to be used in ordering. Refer to pink insert for prices.	Plate No.
43281 L	Folder Swinging Arm Latch, for styles in Class 52800, Style 52700 F (screw No. 22562) - - - - -	13
43294 A	Oil Drain Support- - - - -	38
43294 D	" " Pipe, 3 inches long- - - - -	33
43294 E-108	Oil Drain Pipe, 6 3/4 inches long, for machines installed on table tops ranging from 2 1/4 to 5 inches thick - - - - -	33
K44956	Feed Dog, for making 1/2 inch belt loops on No. 12 gauge Style 52700 A (screw No. 22528) - - - - -	--
51104 D	Cast-off Guide Wire, for styles in Class 53500 (screw No. 22593)- - - - -	25
151134	Feed Bar, including tiltable feed dog holder, for styles in Class 53500, Styles 52700 A, 52700 B, 52700 G, 52700 H (set screw No. 22560 B, feed dog supporting screw No. 538, feed dog holder adjusting screw No. 22863, link pin screw No. 22768) - - - - -	28
151134 A	Feed Bar, including tiltable feed dog holder, for styles in Class 52900 (set screw No. 166, feed dog supporting screw No. 538, feed dog holder adjusting screw No. 22863, link pin screw No. 22768) - - - - -	28
51134 G	Feed Dog Holder, tiltable (nut No. 258 A, washer No. 6042 A) - - - - -	16
51147	Main Shaft Collar (screw No. 95) - - - - -	12
51158 D	Looper Thread Take-up Eyelet, for styles in Class 53500 (screw No. 22593)- - - - -	15
51170 C	Needle Thread Take-up Post, for styles in Class 53500; Styles 52700 A, 52700 B, 52700 H- - - - -	19
51170 D	Needle Thread Take-up Post Lock Nut- - - - -	12
51201 B	Cloth Plate, for Styles 52700 A, 52700 B, using throat plates 3 1/8 inches long (screw No. 80) - - - - -	41
51202	Cloth Plate Slide, rear, 1 1/2 inches long, for styles in Class 53500, Styles 52700 A, 52700 B, 52700 G, 52700 H (stop screw No. 22799 N) - - - - -	26
51213	Looper Rocker, for styles in Classes 52700, 52800 - - - - -	27
151215 A	Needle Lever, steel, for styles in Classes 52800, 52900, Styles 52700 A, 52700 B, 52700 G, 52700 H (set screw for link pin No. 77)- - - - -	38

LIST OF PARTS

Symbol to Order by	The figures in the last column refer only to the plates illustrating the parts and are not to be used in ordering. Refer to pink insert for prices.	Plate No.
‡51215 B	Needle Lever, lynite, for styles in Class 53500, Style 52700 F (clamp screw for link pin No. 22864, clamp screw nut No. 51250 C)	38
51216	Needle Lever Connecting Rod Tube (nut, left thread, No. 15430 C, nut, right thread, No. 15430 D- - - - -)	24
‡51216 A	Needle Lever Connecting Rod Upper Bearing (screw No. 97 A) - - - - -	27
51221	Pulley, working diameter 2 1/2 inches, for styles in Class 53500 (spot screw No. 22597, set screw No. 22597 A)- - - - -	33
51222	Main Shaft, left section, for styles in Classes 52700, 52800, 53500- - - - -	36
‡51222 B	Crankshaft Assembly, for styles in Classes 52700, 52800, 52900, includes crankshaft No. 51222 A (bearing screw No. 75 A) - - - - -	36
51225	Needle Guard, for styles in Class 53500 (attaching screw No. 22585 B, washer No. 39236 A) - - - - -	8
51235	Feed Rocker, for styles in Classes 52900, 53500, Styles 52700 A, 52700 B, 52700 G, 52700 H (screw No. 98) - - - - -	28
51235 A	Feed Rocker Arm, for styles in Classes 52900, 53500, Styles 52700 A, 52700 B, 52700 G, 52700 H (clamp screw No. 93) - - - - -	28
51235 B	Feed Rocker Shaft, 4 7/16 inches long, for styles in Class 53500; Styles 52700 A, 52700 B, 52700 G, 52700 H- - - - -	24
51236	Feed Crank Link (oil wick No. 666-19, shim No. 1248, screw No. 22569, nut No. 7947) - - - - -	20
51236 A	Feed Crank Link Pin (screw No. 77) - - - - -	13
51236 B	Stitch Regulating Stud Cap (screw No. 22768)	18
51236 C	Feed Crank Stud (nut No. 269)- - - - -	20
51240 A	Looper Connecting Rod, adjusting section, for styles in Class 53500; also ruffler eccentric connecting rod, lower, for Style 53500 C (nut, right thread, No. 18, nut, left thread, No. 269)- - - - -	13
51240 C	Upper Knife Spring, for styles in Class 52900; also for No. 53545 - - - - -	14
‡51241 D	Looper Connecting Rod Ball Joint Assembly, left (bearing screw No. 97 A)- - - - -	20
‡51242 A	Looper Drive Lever Shaft, 4 9/16 inches long, with bushing (screw No. 22597 A) - - - - -	23
51242 B	Looper Drive Lever Shaft Bushing, rear, for Styles 52700 A, 52700 B, 52700 G, 52700 H- - - - -	18
51242 C	Looper Drive Lever Bushing - - - - -	18
51242 E	Looper Drive Lever, lynite, for styles in Class 53500- - - - -	28

LIST OF PARTS

Symbol to Order by	The figures in the last column refer only to the plates illustrating the parts and are not to be used in ordering. Refer to pink insert for prices.	Plate No.
51243 B	Needle Lever Ball Stud; also looper drive lever ball stud on styles in Class 53500 (set screw, hexagonal head, No. 22519)- - -	20
51243 C	Looper Drive Lever Ball Stud Guide Fork; also for No. 51243 B (screw No. 97)- - - - -	20
51243 K	Looper Drive Eccentric Oil Disc (screw No. 22716)- - - - -	29
51243 L	Looper Drive Eccentric Oil Disc Gasket- - - -	29
51243 N	Looper Drive Eccentric Oil Disc Washer, steel (screw No. 22716 A) - - - - -	29
51243 R	Looper Drive Eccentric Oil Pad Clip - - - - -	17
51244	Looper Rocker Frame, for styles in Classes 52700, 52800, 52900 (spot screw No. 96, set screw No. 98) - - - - -	27
51244 A	Looper Rock Shaft - - - - -	24
51244 B	" " " Arm (clamp screw No. 93)- - -	20
51244 C	Looper Rock Shaft Sleeve, for styles in Classes 52700, 52800 (screw No. 88 B) - - -	18
51244 E	Looper Rock Shaft Bushing - - - - -	18
51245	Looper Avoid Eccentric Link and Feed Lift Eccentric Link (shim No. 51245 A, screw No. 22569, nut No. 7947)- - - - -	20
51245 A	Looper Avoid Eccentric Link Oil Retaining Pad	12
51246	Looper Rocker Stud Nut- - - - -	12
51250	Needle Lever Stud (screw No. 719) - - - - -	23
51250 B	" " Thrust Collar (screw No. 719)- - -	18
51250 C	Needle Lever Link Pin Clamp Screw Nut, for styles in Class 53500, Style 52700 F- - - -	12
51254	Needle Bar Bushing, upper - - - - -	18
51254 A	" " " lower - - - - -	18
51280 A	Throat Plate Support, for Styles 52700 G, 52700 H, using throat plates 2 1/4 inches long (screw No. 80) - - - - -	37
51280 K	Dowel Pin, for main shaft oil gauge assembly	13
51281-157	Cloth Plate Cover, 4 59/64 inches long, for styles in Class 53500 - - - - -	37
51281-226	Cloth Plate Cover, 7 1/16 inches long, for Styles 52700 A, 52700 B - - - - -	37
51281-233	Cloth Plate Cover, 7 9/32 inches long, for Styles 52700 G, 52700 H - - - - -	37
51281 F	Cloth Plate Cover Spring (screw No. 22726 A)	26
51282	Louver Cover (screw No. 90) - - - - -	26
51282 B	Face Plate, for styles in Class 53500, Styles 52700 A, 52700 B (thumbscrew No. 22837) - -	31
51282 H	Crank Chamber Oil Reservoir Gasket- - - - -	26
51282 J	Crank Chamber Oil Reservoir, including tubes and sight gauge No. 39193, for styles in Class 52700 (attaching screw, right, No. 22849, attaching screw, left, No. 35768 A)	36



LIST OF PARTS

Symbol to Order by	The figures in the last column refer only to the plates illustrating the parts and are not to be used in ordering. Refer to pink insert for prices.	Plate No.
51283	Lifter Lever, for styles in Classes 52700, 53500 (stud No. 22566 A)- - - - -	41
51283 A	Lifter Lever Spring, for styles in Classes 52700, 53500- - - - -	14
51283 B	Lifter Lever Spring Pin, for styles in Classes 52700, 53500- - - - -	13
51290	Main Shaft Bushing, inner, left, 3/4 inch long- - - - -	18
51290 D	Main Shaft Bushing, left, 3/4 inch long - -	18
51290 E	" " " middle- - - - -	18
‡51290 N	Main Shaft Bushing Housing, includes bushing, for styles in Class 52700- - - - -	36
51291	Looper Thread Guard, for styles in Class 53500 (screw No. 22711) - - - - -	31
51292	Tension Post- - - - -	15
51292 A	" " Ferrule- - - - -	12
51292 C	" Regulating Nut- - - - -	12
51292 D	" Thread Eyelet, for styles in Classes 52700, 52800, 52900 - - - -	15
51292 E	" Thread Eyelet, for styles in Class 53500 - - - - -	15
51292 F-1	" Spring, .016 inch diameter wire, for looper threads- - - - -	14
51292 F-2	" Spring, .022 inch diameter wire, for looper threads; also spreader thread on styles in Class 52800 - -	14
51292 F-4	" Spring, .026 inch diameter wire, for needle threads; also spreader thread on styles in Class 52900 - -	14
51292 F-5	" Spring, .031 inch diameter wire, for needle threads- - - - -	14
51292 F-8	" Spring, .037 inch diameter wire, for needle threads- - - - -	14
51293 A	Crank Chamber Oil Tube, for outer right main shaft bearing on styles in Classes 52700, 52800, 52900 - - - - -	24
51293 B	Crank Chamber Oil Tube Clamp, for styles in Classes 52700, 52800, 52900 (screw No. 22769)- - - - -	17
51293 K	Crank Chamber Oil Tube, for inner left main shaft bearing on styles in Class 53500- -	29
51294 A	Oil Drain Clamp Spring- - - - -	38
51295	Isolated Insulators, for "II" installation	17
51296	Machine Base Dowel Pin, front - - - - -	17
51296 A	Machine Base Dowel Pin, rear- - - - -	17
51301 A	Cloth Plate, for Styles 52700 G, 52700 H, using throat plate 2 1/4 inches long (screw No. 80)- - - - -	41

LIST OF PARTS

Symbol to Order by	The figures in the last column refer only to the plates illustrating the parts and are not to be used in ordering. Refer to pink insert for prices.	Plate No.
51321 A	Pulley, working diameter 2 1/2 inches, for styles in Classes 52700, 52800, 52900 (spot screw No. 22597, set screw No. 22597 A) - -	33
51430 F	Presser Foot Regulating Screw Lock Nut, for Styles 52700 F, 53500 G, 53500 D- - - - -	12
51458	Needle Lever Thread Eyelet, for Styles 52700 A, 52700 B, 52700 H, 52800 E, 52800F, 52800 G, 52800 H, 52800 J (screw No.22768)	15
51458 A	Needle Bar Thread Eyelet, for styles in Class 53500, Styles 52700 A, 52700 B, 52700 H, 52800 E, 52800 F, 52800 G, 52800 H, 52800 J (screw No. 22768, lock washer No. 652 C-9)	15
51480	Throat Plate Support, for Styles 52700 A, 52700 B, using throat plates 3 1/8 inches long (screw No. 22839)- - - - -	37
51491 A	Looper Thread Guard, for Styles 52700 A, 52700 B, 52700 G, 52700 H (screw No. 22848)	31
‡51741 B	Looper Connecting Rod Ball Joint Assembly, right, for styles in Classes 52700, 52800, 52900 (bearing screw No. 97 A)- - - - -	20
‡51743 B	Main Oil Reservoir, for styles in Class 53500 (screw No. 93)- - - - -	41
51745	Looper Rocker Cone Stud - - - - -	20
51758	Frame Needle Thread Eyelet, intermediate, for styles in Classes 52800, 52900 (attaching screw No. 22848, adapter screw No. 22840, washer No. 20)- - - - -	15
51758 A	Frame Needle Thread Guide, for Style 52700 F (screw No. 22730) - - - - -	15
51773	Looper Rocker Frame Spacing Collar, for styles in Class 53500 - - - - -	12
K51893	Presser Foot, for No. 16 gauge Style 52700 H (clamp screw No. 91 - - - - -	--
K51896	Face Plate, for Styles 52700 G, 52700 H (thumb screw No. 22837) - - - - -	--
51958	Needle Lever Thread Eyelet, for Styles 52700 F, 52700 G, 52800 B, 52800 D, 52800 K, 52900 A, 52900 B (screw No.22768)	15
51958 A	Needle Bar Thread Eyelet, for Styles 52700 F, 52700 G, 52800 B, 52800 D, 52800 K, 52900 A, 52900 B (screw No. 22768, lock washer No. 652 C-9) - - - - -	15
51958 B	Frame Needle Thread Eyelet, for Styles 52700 F, 52700 G (attaching screw No. 22848, adapter screw No. 22840, washer No. 20) - - - - -	15
51959 B	Looper Thread Nipper Disc, for styles in Classes 52700, 52800- - - - -	15

LIST OF PARTS

Symbol to Order by	The figures in the last column refer only to the plates illustrating the parts and are not to be used in ordering. Refer to pink insert for prices.	Plate No.
51959 C	Looper Thread Nipper Spring, for styles in Classes 52700, 52800 - - - - -	14
51959 D	Looper Thread Nipper Stud Nut, for styles in Classes 52700, 52800- - - - -	12
51959 E	Looper Thread Nipper Stud Spacing Collar, for styles in Classes 52700, 52800 - - -	13
K52499	Table Top, 48" x 16" x 1 3/4", prepared completely for nonsubmerged group installations- - - - -	--
52705 G	Feed Dog, for Style 52700 G (screw No. 22528) - - - - -	3
52708 A	Looper, for Styles 52700 A, 52700 B (set screw No. 73)- - - - -	8
52710	Looper Needle Guard, marked "AJ" for Styles 52700 A, 52700 B (screw No. 73 A)	8
52710 F	Looper Needle Guard, for Styles 52700 F, 52800 K (screw No. 73 A) - - - - -	8
52717 B-12	Needle Bar, marked "BH-12", for No. 12 gauge Styles 52700 A, 52700 B, 52800 H, 52800 J (set screw No. 88 A) - - - - -	23
52717 B-16	Needle Bar, marked "BH-16", for No. 16 gauge Styles 52700 A, 52700 B, 52700 H (set screw No. 88 A) - - - - -	23
52718-12	Needle Holder, marked "F-12", for No. 12 gauge Styles 52700 A, 52700 B, 53500 C, 53500 D (spot screw No. 89, needle set screw No. 22580) - - - - -	8
52720 B-12	Presser Foot, for No. 12 gauge Style 52700 B (clamp screw No. 91, adjustable section No. 52730 B, adjustable section screw No. 22593) - - - - -	5
52720 B-16	Presser Foot, for No. 16 gauge Style 52700 B (clamp screw No. 91, adjustable section No. 52730 B, adjustable section screw No. 22593) - - - - -	5
52720 F-12	Presser Foot Assembly, for No. 12 gauge Style 52700 F; one each Nos. 52730 F-12, 57 WD, 91, 223 C, 22738, 22799 B, 22840 A, 51430 F, 52730 J, 52730 K, 52730 L, 52730 M, 52730 N; two No. 22561) - - - - -	4
52720 G-16	Presser Foot Assembly, for No. 16 gauge Style 52700 G; one each Nos. 52730 G-16, 57 WD, 91, 604, 15480 C, 52730, 52730 A, 52730 C- - - - -	4
52720 H-8	Presser Foot Assembly, for No. 8 gauge Style 52700 H; one each Nos. 52730 H-8, 57 WD, 91, 604, 15480 C, 52730, 52730 A, 52730 C- - - - -	4

LIST OF PARTS

Symbol to Order by	The figures in the last column refer only to the plates illustrating the parts and are not to be used in ordering. Refer to pink insert for prices.	Plate No.
52720 H-12	Presser Foot Assembly, for No. 12 gauge Style 52700 H; one each Nos. 52730 H-12, 57 WD, 91, 604, 15480 C, 52730, 52730 A, 52730 C- - - - -	4
52723 A	Shielded Disc Take-up, for Style 52700 F (spot screw No. 96, set screw No. 22580)	25
52724 A-12	Throat Plate, for No. 12 gauge Style 52700 A- - - - -	1
52724 A-16	Throat Plate, for No. 16 gauge - - - - -	1
52724 B-12	" " for No. 12 gauge Style 52700 B	1
52724 B-16	" " for No. 16 gauge - - - - -	1
	Throat Plate Screw No. 22570	
52724 F-12	" " for No. 12 gauge Style 52700 F	2
52724 G-16	" " for No. 16 gauge Style 52700 G	2
52724 H-8	" " for No. 8 gauge Style 52700 H	1
52724 H-12	" " for No. 12 gauge- - - - -	1
	" " Screw No. 87	
52730	Presser Foot Shank, for Styles 52700 G, 52700 H (clamp screw No. 91) - - - - -	--
52730 A	Presser Foot Adjustable Guide, for Style 52700 G; also for Nos. 8 and 12 gauge Style 52700 H (screw No. 604)- - - - -	6
52730 B	Presser Foot Adjustable Section, for Style 52700 B (screw No. 22593)- - - - -	7
52730 C	Presser Foot Adjustable Guide Roller, for Style 52700 G; also for Nos. 8 and 12 gauge Style 52700 H- - - - -	7
52730 F-12	Presser Foot Bottom, for No. 12 gauge Style 52700 F- - - - -	6
52730 G-16	Presser Foot Bottom, for No. 16 gauge Style 52700 G- - - - -	6
52730 H-8	Presser Foot Bottom, for No. 8 gauge Style 52700 H- - - - -	6
52730 H-12	Presser Foot Bottom, for No. 12 gauge- - - - -	6
52730 J	Presser Foot Hinged Section, for Style 52700 F (pivot Screw No. 223 C)- - - - -	6
52730 K	Presser Foot Adjustable Guide, left, for Style 52700 F (screw No. 22561)- - - - -	7
52730 L	Presser Foot Adjustable Guide, right, for Style 52700 F (screw No. 22561)- - - - -	7
52730 M	Presser Foot Bottom Spring, for Style 52700 F (stud No. 57 WD) - - - - -	7
52730 N	Presser Foot Shank, for Style 52700 F (clamp screw No. 91) - - - - -	--
52742 A	Looper Drive Lever, for styles in Classes 52700, 52800, 52900- - - - -	28
52770 A	Needle Thread Take-up, for Styles 52700 A, 52700 B, 52700 H (screw No. 90)- - - - -	25

LIST OF PARTS

Symbol to Order by	The figures in the last column refer only to the plates illustrating the parts and are not to be used in ordering. Refer to pink insert for prices.	Plate No.
52782 H	Crank Shaft Chamber Cover Oil Catch Plate, for styles in Class 53500 (screw No. 187 A)	26
52795	Main Shaft Oil Gauge Assembly, for styles in Classes 52700, 53500; one each Nos. 52895 G, 660-92, 660-93, 660-94, 660-95, 51280 K - - - - -	29
52801	Cloth Plate, for styles in Class 52800, Style 52700 F (screw No. 80) - - - - -	41
52802	Cloth Plate Sliding Cover, for styles in Class 52800, Style 52700 F - - - - -	26
52802 A	Cloth Plate Slide, rear, 1 3/4 inches long, for styles in Classes 52800, 52900, Style 52700 F (stop screw No. 22799 N) - - - - -	26
52804	Cast-off Plate, for styles in Class 52800 (screw No. 28) - - - - -	25
52804 A	Cast-off Plate, for styles in Class 52700 (screw No. 28) - - - - -	25
52805 B	Main Feed Dog, for Style 52800 B - - - - -	3
52805 D-16	" " " for Style 52800 D - - - - -	3
52805 E-8	" " " for Style 52800 E - - - - -	3
52805 F-8	" " " for Styles 52800 F, 52800 H - - - - -	3
52805 K	" " " for Style 52800 K - - - - - " " " Screw No. 22593	3
52808 E	Looper, for styles in Class 52800, Styles 52700 F, 52700 G, 52700 H; also front looper for styles in Class 52900 (set screw No. 73) - - - - -	8
52810 E	Looper Needle Guard, for styles in Class 52800, Styles 52700 G, 52700 H (screw No. 73 A) - - - - -	8
52816	Spreader Eccentric Connecting Rod, for styles in Classes 52800, 52900 (nut, left thread, No. 269, nut, right thread, No. 15430 D) - - - - -	24
52816 F	Spreader Eccentric Oil Retaining Disc (screw No. 22716 A) - - - - -	29
52817-12	Needle Bar, marked "BD-12", for No. 12 gauge Style 52700 F - - - - -	23
52817-16	Needle Bar, marked "BD-16", for No. 16 gauge Styles 52800 B, 52800 D, 52800 K - - - - -	23
52817 E-8	Needle Bar, marked "BG-8", for No. 8 gauge Styles 52700 H, 52800 E, 52800 F, 52800 G - - - - -	23
52818-8	Needle Bar Set Screw No. 88 A Needle Holder, for styles in Class 52800, Styles 52700 F, 52700 H (thread guide No. 52842 G, thread guide screw No. 28 B, needle holder set screw No. 88, needle set screw No. 88 B) - - - - -	8

LIST OF PARTS

Symbol to Order by	The figures in the last column refer only to the plates illustrating the parts and are not to be used in ordering. Refer to pink insert for prices.	Plate No.
52820 G-8	Presser Foot Assembly, for No. 8 gauge Style 52800 G (clamp screw No. 91, edging roller No. 3045, bottom spring No. 52830 G, spring stud No. 57 WD) - - - - -	4
52820 H-12	Presser Foot Assembly, for No. 12 gauge Style 52800 H; one each Nos. 52830 H-12, 73 A, 91, 605, 11534, 13130 B, 22561, 22799 B, 52830 A, 52830 B - - - - -	4
52823	Shielded Disc Take-up, for styles in Class 52800, Styles 52700 A, 52700 B, 52700 G, 52700 H (spot screw No. 96, set screw No. 22580)- - - - -	25
52824 B-16	Throat Plate, for No. 16 gauge Style 52800B	2
52824 D-16	" " for No. 16 gauge Style 52800D	2
52824 E-8	" " for No. 8 gauge Style 52800 E	2
52824 F-8	" " for No. 8 gauge Style 52800 F	1
52824 F-12	" " for No. 12 gauge Style 52800H	1
52824 K-16	" " for No. 16 gauge Style 52800K " " Screw No. 87	2
52826 G	Differential Feed Dog, for No. 8 gauge Style 52800 G (screw No. 90)- - - - -	3
52826 K	Differential Feed Dog, for Style 52800 K (screw No. 90)- - - - -	3
52830 A	Presser Foot Yielding Section, for No. 12 gauge Style 52800 H - - - - -	6
52830 B	Presser Foot Adjustable Guide, for No. 12 gauge Style 52800 H (screw No. 22561) - -	7
52830 G	Presser Foot Bottom Spring, for Style 52800 G (stud No. 57 WD)- - - - -	7
52830 H-12	Presser Foot Bottom, for No. 12 gauge Style 52800 H - - - - -	6
52834	Main Feed Bar, for styles in Class 52800, Style 52700 F (set screw No. 22560 B) - -	28
52834 G	Differential Feed Bar, for styles in Class 52800, Style 52700 F- - - - -	28
52834 N	Looper Drive Ball Joint Locking Stud Nut- -	12
52836	Feed Rocker, for styles in Class 52800, Style 52700 F (screw No. 89)- - - - -	28
52836 C	Feed Rocker Arm, for styles in Class 52800, Style 52700 F (clamp screw No. 93)- - - -	28
52836 G	Feed Rocker Segment Slot Plate, for styles in Class 52800, Style 52700 F (screw, upper, No. 22516, screw, lower, No. 75)	28
52836 N	Feed Rocker Segment Slot Plate Shim, for styles in Class 52800, Style 52700 F- - -	28
52841	Looper Drive Ball Joint Locking Stud (washer No. 8372 A, nut No. 52834 N)- - -	13
52842	Needle Bar Spreader Thread Eyelet Support, for styles in Classes 52800, 52900 (screw No. 22560)- - - - -	20

LIST OF PARTS

Symbol to Order by	The figures in the last column refer only to the plates illustrating the parts and are not to be used in ordering. Refer to pink insert for prices.	Plate No.
52842 G	Needle Holder Needle Thread Guide, for styles in Classes 52800, 52900, Styles 52700 F, 52700 H (screw No. 28 B) - - - - -	15
52844 A	Spreader Thread Guide, for styles in Classes 52800, 52900 (screw No. 90) - - - - -	25
52845	Spreader, for styles in Class 52900 (set screw No. 22593) - - - - -	8
52845 A	Spreader, for styles in Class 52800 (set screw No. 22593) - - - - -	8
52846	Spreader Holder, for styles in Classes 52800, 52900 (set screw No. 88) - - - - -	16
52847	Spreader Holder Carrier and Lower Presser Bar Bushing, for styles in Classes 52800, 52900	28
‡52848 A	Spreader Connecting Rod Assembly, for styles in Classes 52800, 52900 (ball stud washer No. 36 G) - - - - -	27
52848 G	Spreader Connecting Rod Guard (screw, upper, No. 90, screw, lower, No. 93 A) - - - - -	31
52849	Spreader Rock Shaft - - - - -	36
52849 A	" " " Arm (clamp screw No. 93)	30
52849 G	" " " Bearing, left (screw No. 22865 A) - - - - -	28
52849 N	" " " Bearing, right (screw No. 22865) - - - - -	28
52852	Spreader Rock Shaft Adjusting Segment Lever (clamp screw No. 22811) - - - - -	30
52852 G	Spreader Rock Shaft Segment Lever Guard (screw No. 22872) - - - - -	26
‡52854	Spreader Rock Shaft Connecting Rod Ball Joint Assembly (bearing screw No. 97 A) - - - - -	20
52855	Spreader Thread Take-up Eyelet (screw No. 22872) - - - - -	25
52855 G	Spreader Thread Take-up (screw No. 95) - - - - -	25
52857	Cast-off Wire Support, for styles in Classes 52700, 52800 (screw No. 22528) - - - - -	25
52864	Cloth Plate Swinging Arm, for styles in Class 52800, Style 52700 F (pivot screw No. 236)	41
52864 B	Cloth Plate Swinging Arm Platform, for Styles 52800 B, 52800 D, 52800 J - - - - -	36
52864 C	Cloth Plate Swinging Arm Platform, for Styles 52700 F, 52800 G - - - - -	36
52864 E	Cloth Plate Swinging Arm Platform, for Styles 52800 E, 52800 F, 52800 H, 52800 K - - - - -	31
52864 G	Folder Swinging Arm Platform Screw No. 90 Cloth Plate Swinging Arm Base, for styles in Class 52800, Style 52700 F (screw No. 79)	30
52864 N	Folder Support Bracket, for Styles 52800 E, 52800 F, 52800 H, 52800 K (screw No. 22567)	30

LIST OF PARTS

Symbol to Order by	The figures in the last column refer only to the plates illustrating the parts and are not to be used in ordering. Refer to pink insert for prices.	Plate No.
K52867	Folder, 3/64 inch strip capacity, for attaching split tube borders on Style 52800 F, 7/8 inch finish, strip cut 1 3/4 inches wide (screw No. 25 CC)- - - - -	--
52880	Throat Plate Support, for styles in Class 52800, Style 52700 F (screw No. 22574) - - -	37
‡52882	Crank Chamber Oil Reservoir, including tubes and sight gauge No. 39193, for styles in Classes 52800, 52900 (attaching screw, right, No. 22849, attaching screw, left, No. 35768A)	36
52882 A	Face Plate, for styles in Class 52900, Styles 52800 B, 52800 D, 52800 E, 52800 F, 52800 H, 52800 J, 52800 K (thumbscrew No. 22837)- - -	31
52882 B	Crank Chamber Cover, rear (screw No. 90) - - -	26
52882 C	Face Plate, for Style 52800 G (thumbscrew No. 22837) - - - - -	31
52882 D	Crank Chamber Oil Reservoir Cover Assembly; one each Nos. 666-50, 35788 B (screw No. 605)	26
52883	Lifter Lever, for styles in Classes 52800, 52900 (stud No. 22566 A) - - - - -	41
52883 G	Presser Bar Lifter Bracket and Guide (screw No. 89)- - - - -	25
52885 A	Cloth Plate End Cover, for styles in Classes 52800, 52900, Style 52700 F- - - - -	41
52885 G	Cloth Plate End Cover Hinge, front, including pin (screw No. 22848)- - - - -	19
52885 H	Cloth Plate End Cover Hinge, rear (screw No. 22848) - - - - -	19
52887	Cloth Plate End Cover Hinge Pin No. 39132 V	
52887	Presser Spring (locating screw No. 35768 A)- -	23
52887 G	" " Rest- - - - -	18
52888	" Bar- - - - -	24
52889	" " Bushing, upper - - - - -	18
‡52891	Main Shaft Bushing Housing, includes bushing, for styles in Classes 52800, 52900 - - - - -	36
‡52894 A	Main Oil Reservoir, for styles in Classes 52700, 52800 (screw No. 93)- - - - -	41
52894 G	Main Oil Reservoir Cover, for styles in Classes 52700, 52800, 52900 (screw No. 87 A)	35
52894 J	Oil Tube Brace, for styles in Classes 52700, 52800 (screw No. 22585, nut No. 41071 G) - -	29
52894 Y	Oil Line "T" Coupling, for inner right main shaft bearing- - - - -	29
52894 Z	Oil Tube, leading from oil gauge to right main bearing "T" coupling (coupling No. 61294 X)	17
52895	Main Shaft Oil Gauge Assembly, for styles in Classes 52800, 52900 (frame No. 52895 G, glass tube No. 660-94, cap No. 660-95, washer, upper, No. 660-92, washer, lower, No. 660-93)- - - - -	29



LIST OF PARTS

Symbol to Order by	The figures in the last column refer only to the plates illustrating the parts and are not to be used in ordering. Refer to pink insert for prices.	Plate No.
52895 G	Main Shaft Oil Gauge Frame- - - - -	--
52901	Cloth Plate, for styles in Class 52900 (screw No. 80)- - - - -	41
52904	Cast-off Plate, for styles in Class 52900 (screw No. 28)- - - - -	25
52909 A	Looper, rear, for No. 5-8 gauge styles in Class 52900 (set screw No. 73)- - - - -	8
52913	Looper Rocker, for styles in Class 52900- -	27
52917-8	Needle Bar, for styles in Class 52900 (set screw No. 88 A) - - - - -	23
52918-5-8	Needle Holder, for No. 5-8 gauge styles in Class 52900 (thread guide No. 52842 G, thread guide screw No. 28 C, needle hold- er set screw No. 89, needle set screw, front, No. 88 B, needle set screw, rear, No. 28 C) - - - - -	8
52920 A-5-8	Presser Foot Assembly, for No. 5-8 gauge Style 52900 A; one each Nos. 91, 22799 F, 52930, 52930 A- - - - -	5
52920 B-5-8	Presser Foot Assembly, for No. 5-8 gauge Style 52900 B; one each Nos. 91, 605, 22799 F, 52930, 52930 B, 52930 C, 52930 D, 52930 E, 52930 F - - - - -	5
52922	Main Shaft, left section, for styles in Class 52900 - - - - -	36
52923	Shielded Disc Take-up, for styles in Class 52900 (spot screw No. 96, set screw No. 22580)- - - - -	25
52925	Needle Guard, for styles in Class 52900 (screw No. 22585 B, washer No. 39236 A)	8
52926 A-5-8	Feed Dog, for No. 5-8 gauge Styles 52900 A, 52900 B (screw No. 22528) - - - - -	4
52928 A-5-8	Throat Plate, for No. 5-8 gauge Styles 52900 A, 52900 B (screw No. 87))- - - - -	2
52930	Presser Foot Shank, for No. 5-8 gauge Styles 52900 A, 52900 B (clamp screw No. 91) - - - - -	--
52930 A	Presser Foot Bottom, for No. 5-8 gauge Style 52900 A (hinge screw No. 22799 F)	6
52930 B	Presser Foot Bottom, for No. 5-8 gauge Style 52900 B (hinge screw No. 22799 F)	6
52930 C	Presser Foot Needle Hole Section, for No. 5-8 gauge Style 52900 B - - - - -	7
52930 D	Presser Foot Needle Hole Section Spring, for No. 5-8 gauge Style 52900 B - - - - -	7
52930 E	Presser Foot Needle Hole Section Spring Spacing Sleeve, for No. 5-8 gauge Style 52900 A - - - - -	7

LIST OF PARTS

Symbol to Order by	The figures in the last column refer only to the plates illustrating the parts and are not to be used in ordering. Refer to pink insert for prices.	Plate No.
52930 F	Presser Foot Chain Cutting Knife, for Style 52900 B (screw No. 605)- - - - -	7
52943 A	Oil Tube Brace, 1 5/8 inch centers, for styles in Class 52900 (screw No. 22585, nut No. 41071 G) - - - - -	29
52943 B	Oil Tube Brace, 1 1/8 inch centers, for styles in Class 52900 (screw No. 22585, nut No. 41071 G) - - - - -	29
52943 C	Main Oil Reservoir, for styles in Class 52900 (screw No. 93) - - - - -	41
52944 G	Looper Rock Shaft Sleeve, for styles in Class 52900 (screw No. 88 B) - - - - -	28
52949	Lower Knife, double end, for styles in Class 52900- - - - -	8
52950	Lower Knife Holder (clamp screw No. 35766, adjusting screw No. 22568) - - - - -	25
52950 G	Lower Knife Clamp Plate (screw No. 22588 A)	18
52957	Cast-off Wire Support, for styles in Class 52900 (screw No. 22848)- - - - -	25
52958	Looper Thread Cast-off Support Thread Eyelet, for No. 5-8 gauge styles in Class 52900 (screw No. 22768)- - - - -	15
52970 A	Upper Knife, for styles in Class 52900 - - -	8
52971 A	" " Holder (screw No. 22516)- - -	25
52971 H	" " Clamp Plate (screw No. 22799 N)	18
52972	" " Holder Guide Collar (screw No. 22830)- - - - -	18
52973 A	" " Holder Rocker Arm (screw No. HA73 B) - - - - -	30
52973 H	" " Holder Rocker Arm Bracket (screw No. 22788) - - - - -	30
52974 G	" " Holder Rocker Arm Connecting Rod Shim- - - - -	12
52978 A-8	Chip Guard, flexible, for styles in Class 52900 (pivot screw No. 22599, tension spring No. 52978 N, tension spring screw No. 21629) - - - - -	31
52978 N	Chip Guard Tension Spring (screw No. 21629)	14
52980	Throat Plate Support, for styles in Class 52900 (screw No. 22574)- - - - -	37
52981 A	Cloth Plate Cover, for styles in Class 52900	31
52981 G	" " " Locking Spring- - - - -	14
52981 P	Cloth Plate Cover Locking Spring Knob (nut No. 12934 A, washer No. 8372 A)- - - - -	17
52992	Tension Post Support, for styles in Class 52900- - - - -	22
52994	Knife Eccentric Oil Guard for styles in Class 52900 (screw No. 187 A)- - - - -	26
52998	Knife Grinder, complete, for knives Nos. 52949, 52970 A - - - - -	32

LIST OF PARTS

Symbol to Order by	The figures in the last column refer only to the plates illustrating the parts and are not to be used in ordering. Refer to pink insert for prices.	Plate No.
52998 A	Knife Grinder Swinging Frame, for knife grinder No. 52998 (screw No. 22591) - - -	32
52998 B	Knife Grinder Swinging Frame Top Plate (screw No. 22585) - - - - -	32
52998 C	Knife Positioning Lever, for knife grinder No. 52998 (screw No. 22812) - - - - -	19
K53189	Needle Thread Take-up, for styles in Class 53500 (screw No. 90) - - - - -	--
K53259	Elastic Guide and Tension Assembly, for Style 52700 F (tension regulating screw No. 22703, tension regulating screw lock nut No. 907, adjustable guide screw No. 187 A) - - - - -	--
K53260	Edge Guide, for Style 52700 F (pivot screw No. 22735, pivot screw washer No. 12957 E, adjustable section screw No. 357)	--
K53273	Folder, 1/16 inch strip capacity, for attaching collarettes on Styles 52800 H, 52800 K, 7/8 inch finish, strip cut 1 3/4 inches wide (attaching screw No. 25 CC) - - - - -	--
K53274	Folder, 1/16 inch strip capacity, for attaching collarettes on Styles 52800 H, 52800 K, 1 inch finish, strip cut 2 inches wide (attaching screw No. 25 CC)	--
K53423	Table Board, 48" x 16" x 1 3/4", includes base plate No. 21680 AK, prepared completely for semisubmerged isolated line assembly installation with "Electro Drive", for styles in Classes 52800, 52900, Style 52700 F - - - - -	--
K53441	Face Plate, for Style 52700 F (thumbscrew No. 22837) - - - - -	--
K53464	Needle Guard, attaches to under side of feed dog shank, for Style 52700 F (screw No. 22561) - - - - -	--
53501	Cloth Plate, for styles in Class 53500 (screw, left, No. 22730, screw, right, No. 9663) - - - - -	41
53501 C	Auxiliary Cloth Plate, for styles in Class 53500 (screw, lower, No. 22548, screw, upper, No. 80) - - - - -	35
K53501	Folder, 3/64 inch strip capacity, for attaching split tube borders on Style 52800 E, 7/16 inch finish, strip cut 7/8 inch wide (screw No. 25 CC) - - - - -	--
53502	Cloth Plate Slide, for styles in Class 53500 - - - - -	26
53505 C-16	Feed Dog, for No. 16 gauge styles in Class 53500 (screw No. 22528) - - - - -	4

LIST OF PARTS

Symbol to Order by	The figures in the last column refer only to the plates illustrating the parts and are not to be used in ordering. Refer to pink insert for prices.	Plate No.
53508 C-16	Looper, right, for No. 16 gauge styles in Class 53500 (set screw No. 73)- - - - -	8
53509 C	Looper, left, for styles in Class 53500 (set screw No. 73)- - - - -	8
53513	Looper Rocker, marked "G" for styles in Class 53500 - - - - -	27
53516	Ruffler Eccentric Connecting Rod, upper, for Style 53500 C (nut, left thread, No. 37 L, nut, right thread, No. 37 R)- - - -	24
53517 C-16	Needle Bar, marked "AZ-16" for No. 16 gauge styles in Class 53500 (set screw No. 88 A)	23
53520 C-16	Presser Foot Assembly, for No. 16 gauge styles in Class 53500; one each Nos. 53530 A-16, 53530 B-16, 91, 187 B, 22561, 22799 B, 22840 A, 51430 F, 53530, 53530 E, 53530 F; two No. 22845 B - - - -	5
‡53522 B	Crankshaft Assembly, for styles in Class 53500; includes crankshaft No. 53522 A (bearing screw No. 75 A)- - - - -	36
53523 C	Single Disc Take-up, for styles in Class 53500 (spot screw No. 22764 A, set screw No. 89) - - - - -	25
53524 C-16	Throat Plate, for No. 16 gauge styles in Class 53500 (screw No. 22570) - - - - -	2
53530	Presser Foot Shank, for styles in Class 53500 (clamp screw No. 91)- - - - -	--
53530 A-16	Presser Foot Bottom, rear section, for No. 16 gauge styles in Class 53500 (hinge screw No. 22799 B)- - - - -	6
53530 B-16	Presser Foot Bottom, front section, for No. 16 gauge styles in Class 53500 (hinge screw No. 22845 B)- - - - -	6
53530 E	Presser Foot Edge Guide, for styles in Class 53500 (screw No. 187 B) - - - - -	7
53530 F	Presser Foot Bottom Spring, for styles in Class 53500 (screw No. 22561) - - - - -	7
53540	Stripper Blade, for styles in Class 53500 (screw No. 25 B)- - - - -	16
53541	Stripper Blade and Folder Support, for styles in Class 53500 (screw No. 22548)	30
53541 H	Stripper Blade and Folder Support Bracket, for styles in Class 53500 (screw No. 22596, washer No. 21657 E)- - - - -	30
53541 N	Stripper Blade Washer Plate, for styles in Class 53500 - - - - -	18
53542	Looper Drive Lever Shaft Washer, for styles in Class 53500 - - - - -	13
53543 C	Main Oil Reservoir Cover, for styles in Class 53500 (screw No. 87 A)- - - - -	35

LIST OF PARTS

Symbol to Order by	The figures in the last column refer only to the plates illustrating the parts and are not to be used in ordering. Refer to pink insert for prices.	Plate No.
53544	Looper Rocker Frame, for styles in Class 53500 (spot screw No. 96, set screw No. 98)	27
53544 A	Looper Rock Shaft Sleeve, for styles in Class 53500 (screw No. 88 B)- - - - -	28
‡53545	Looper Connecting Rod, jointed section and ball joint assembly, for styles in Class 53500 (ball stud washer No. 35149 C, bearing screw No. 97 A) - - - - -	27
53546-16	Ruffler Blade, for No. 16 gauge styles in Class 53500 (screw No. 28)- - - - -	16
53547	Ruffler Blade Tension Plate, for Style 53500C	16
53548	" " Holder, for styles in Class 53500 - - - - -	16
53548 C	" " Holder Spring - - - - -	14
53548 G	" " " " Connection (screw No. 22768)- - - - -	16
53548 N	" " Operating Lever (spot screw No. 81, clamp screw No. 22541)- - - - -	30
53548 P	" " Holder Tilting Lever (screw No. 73 A) - - - - -	16
53548 S	" " Lifter (screw No. 28) - - - - -	16
53549	Rock Shaft, for styles in Class 53500	36
53549 G	" " " Bearing, left (screw No. 22865 A)- - - - -	28
53549 N	" " " Bearing, right (screw No. 22865)- - - - -	28
53552	" Adjusting Segment Lever, for Style 53500 C (clamp screw No. 74)- - - - -	30
53552 C	" Adjusting Segment Lever Clamping Plate, for Style 53500 C (set screw No. 88, spot screw No. 22764, adjusting screw No. 35766)- - - - -	30
53552 D	" Indexed Segment Guide Block, for Style 53500 D (clamp screw No. 136)	30
53552 G	Ruffler Adjusting Segment Lever Sliding Block, for Style 53500 C (screw No. 22867, nut No. 12934 A)- - - - -	25
53552 N	Ruffler Adjusting Segment Lever Clevis, upper, for Style 53500 C- - - - -	16
53552 P	Ruffler Adjusting Segment Lever Clevis, lower	16
53553	Ruffler Adjusting Lever, for Style 53500 C (screw No. 97)- - - - -	30
53553 D	Ruffler Indexed Segment, for Style 53500 D (stop screw No. 22845 A)- - - - -	30
53553 G	Ruffler Adjusting Lever Stop Bracket and Index, for Style 53500 C (screw No. HA61 D)	30
53553 R	Ruffler Adjusting Lever Stop Sleeve (stop screw No. 22799 F, thumbscrew No. 21745 D)	16
53554	Ruffler Adjusting Guide Plunger, for Style 53500 C - - - - -	30

LIST OF PARTS

Symbol to Order by	The figures in the last column refer only to the plate illustrating the parts and are not to be used in ordering. Refer to pink insert for prices.	Plate No.
53554 D	Ruffler Adjusting Block, for Style 53500 C (clamp screw No. 22569) - - - - -	30
53554 J	Ruffler Adjusting Block Pivot Pin Bushing (screw No. 97) - - - - -	19
53556 C	Presser Bar Bushing, lower, for styles in Class 53500 - - - - -	18
53557 C	Cast-off Wire Support, for styles in Class 53500 (screw No. 79) - - - - -	25
53558	Needle Lever Thread Eyelet, for styles in Class 53500 (screw No. 22768) - - - - -	15
53559	Frame Looper Thread Eyelet, for styles in Class 53500 (screw No. 93 A) - - - - -	25
53560 D	Ruffler Indexed Segment Clamping Sleeve, for Style 53500 D - - - - -	18
53561 D	Ruffler Indexed Clamping Sleeve Stud - - - - -	13
53580	Throat Plate Support, for styles in Class 53500 (screw No. 80) - - - - -	37
‡53582 A	Crank Chamber Oil Reservoir, including tubes and sight gauge No. 39193, for styles in Class 53500 (attaching screw, right, No. 22849, attaching screw, left, No. 35768 A)	36
53582 G	Supplemental Face Plate, for styles in Class 53500 (screw, upper, No. 376, screw, lower, No. 22525 A) - - - - -	31
53582 N	Crankshaft Chamber Cover, upper, rear, includes oil catch plate No. 52782 H for styles in Class 53500 - - - - -	26
53592	Tension Post Support, for styles in Class 53500, Styles 52700 F, 52700 G, 52800 B, 52800 D, 52800 K - - - - -	22
53593 A	Oil Tube, for right main shaft bearing and ruffler eccentric on styles in Class 53500	38
53593 B	Oil Tube Clamp, for styles in Class 53500 (screw No. 22769) - - - - -	17
53595 D	Cover, for ruffler adjusting block pivot pin bushing hole on Style 53500 D (screw No. 87)	19
53595 E	Cover, for ruffler adjusting segment lever slot on Style 53500 D (screw No. 22730) - - -	26
K53665	Pulley, working diameter 2 1/2 inches, grooved for "V" belt (spot screw No. 22597, set screw No. 22597 A) - - - - -	--
K53964	Folder, 1/16 inch strip capacity, for attaching collarettes on Styles 52800 H, 52800 K, 1 1/4 inch finish, strip cut 2 1/2 inches wide (attaching screw No. 25 CC) - - - - -	--
K54079	Needle Bar, for No. 14 gauge Style 52800 K (set screw No. 88 A) - - - - -	--

LIST OF PARTS

Symbol to Order by	The figures in the last column refer only to the plates illustrating the parts and are not to be used in ordering. Refer to pink insert for prices.	Plate No.
K54080	Presser Foot, for No. 14 gauge Style 52800 K (clamp screw No. 91, presser foot shank No. 13130 B, yielding section No. 13130 A, yielding section spring screw No. 605, hinge screw No. 22799 B - - - - -)	--
K54081	Throat Plate, for No. 14 gauge Style 52800 K (screw No. 87)- - - - -	--
K54111	Folder, 1/16 inch strip capacity, for attaching collarettes on Styles 52800 H, 52800 K, 3/4 inch finish, strip cut 1 1/2 inches wide (attaching screw No. 25 CC)- - - - -	--
K54459	Looper, for Style 52800 K; also front looper for No. 16-8 gauge Style 52900 B (set screw No. 73) - - - - -	--
K54741	Looper, back, for No. 16-8 gauge Style 52900 B (set screw No. 73)- - - - -	--
K54742	Needle Holder, for No. 16-8 gauge Style 52900 B (thread guide No. K55286, thread guide screw No. 28 C, needle holder set screw No. 89, needle set screw No. 88 B, needle stop plate screw No. 22716)- - - - -	--
K54743	Presser Foot, for No. 16-8 gauge Style 52900 B (clamp screw No. 91, shank No. 52930, needle hole section No. 52930 C, needle hole section spring screw No. 604, hinge screw No. 22799 A)- - - - -	--
K54744	Throat Plate, for No. 16-8 gauge Style 52900 B (screw No. 87)- - - - -	--
K54745	Feed Dog, for No. 16-8 gauge Style 52900 B (screw No. 22528) - - - - -	--
K54758	Table Top, 48" x 16" x 1 3/4", prepared completely for semisubmerged isolated group installation with "Electro Drive" for Styles 52700 A, 52700 B, 52700 G, 52700 H	--
K54900	Looper Thread Take-up Wire, for No. 16-8 gauge Style 52900 B (screw No. 22768) - - - - -	--
K55286	Needle Holder Thread Guide, for No. 16-8 gauge Style 52900 B (screw No. 28 C)- - - - -	--
61267 G	Lifter Lever Spring Pin, for styles in Classes 52800, 52900- - - - -	13
61294 W	Oil Tube Coupling, for oil gauge tube and middle main bearing oil tube- - - - -	17
61294 X	Oil Tube Coupling, for main oil reservoir - - - - -	12

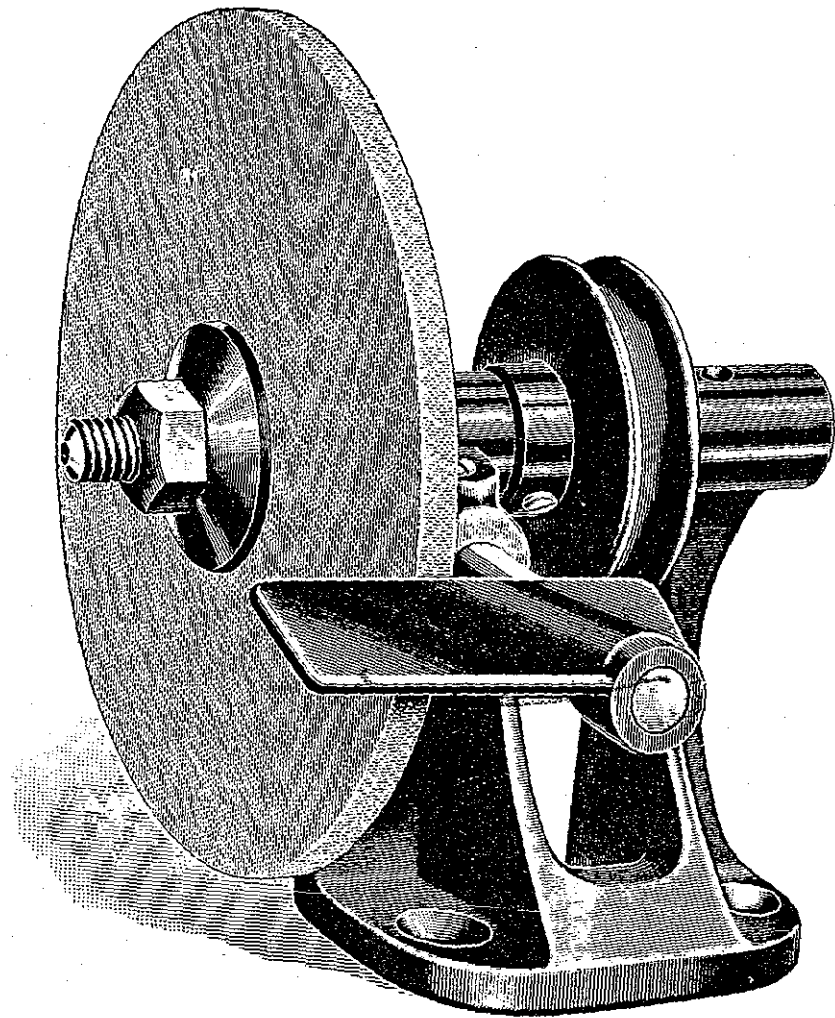

21394  
Utility Grinder



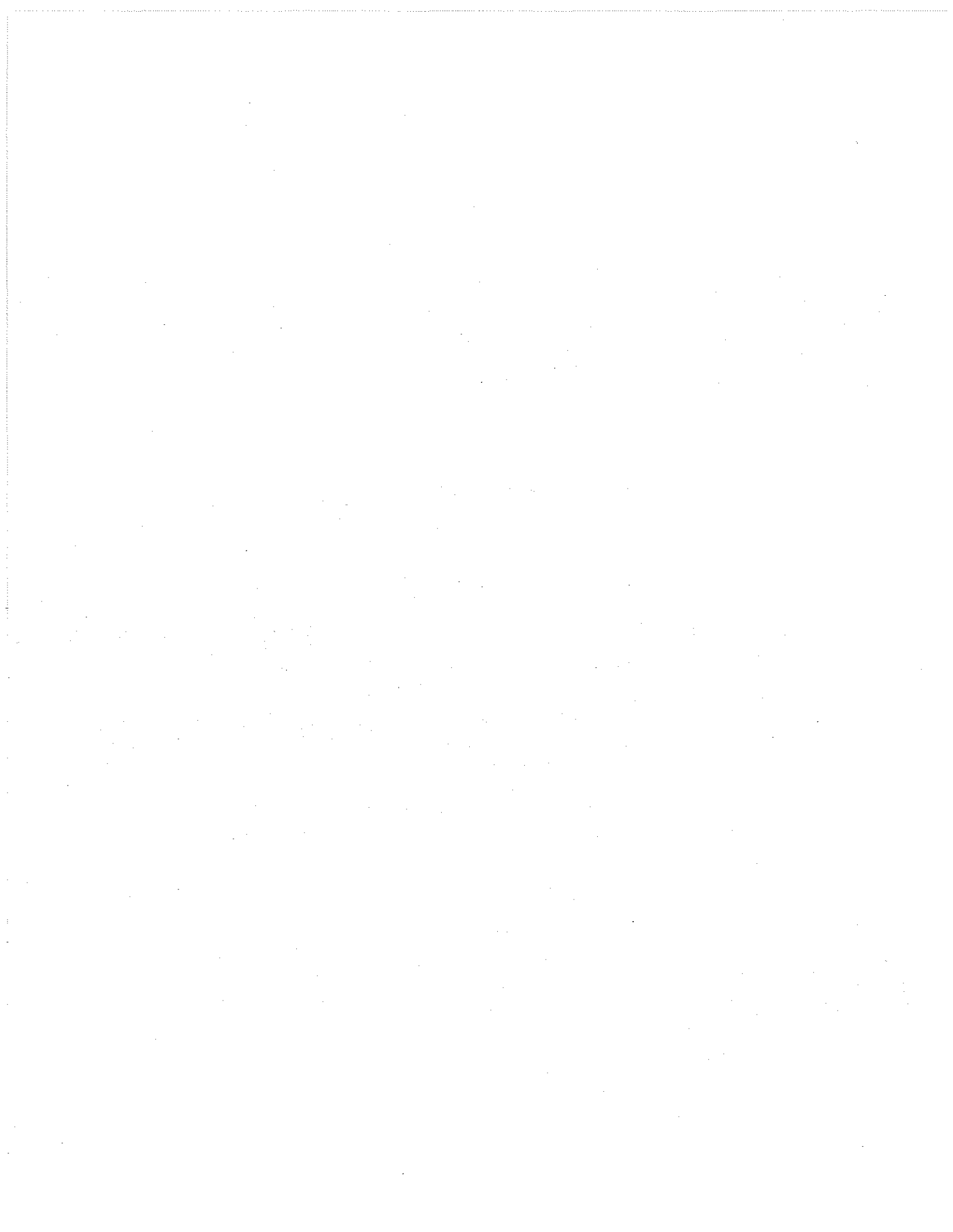

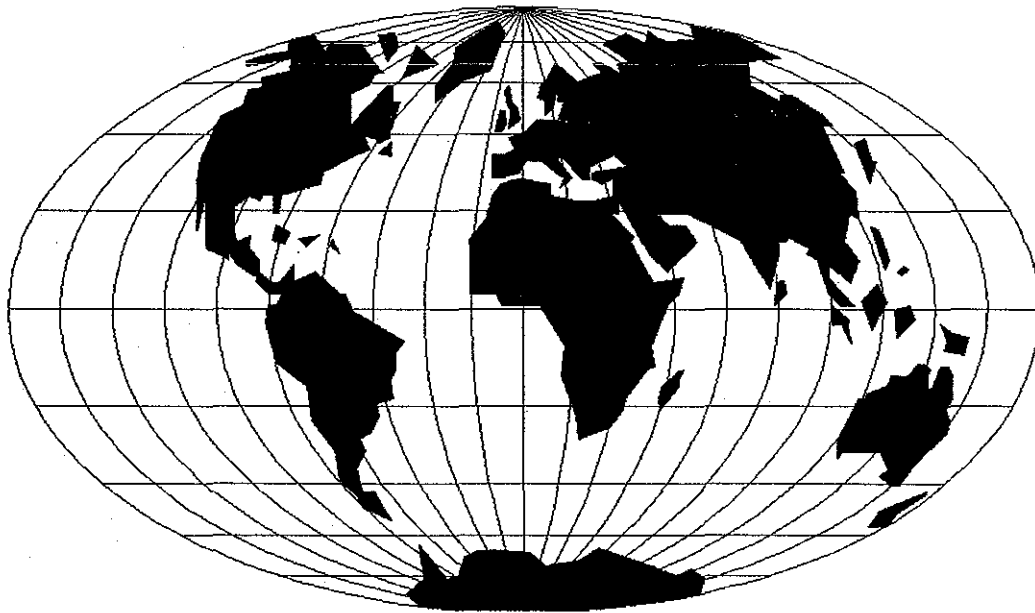

## WORLDWIDE SALES AND SERVICE

Union Special Corporation maintains sales and service facilities throughout the world. These offices will aid you in the selection of the right sewing equipment for your particular operation. Union Special Corporation representatives and service technicians are factory trained and are able to serve your needs promptly and efficiently. Whatever your location, there is a qualified representative to serve you.

---

Corporate Office: One Union Special Plaza  
Huntley, IL 60142  
Phone: 847•669•5101  
Fax: 847•669•1096

European Distribution Center: Union Special GmbH  
Raiffeisenstrasse 3  
D-71696 Möglingen, Germany  
Tel: 49•07141•247•0  
Fax: 49•7141•247•100

Brussels, Belgium  
Charlotte, N.C.  
El Paso, TX  
Hong Kong, China  
Huntley, IL  
Leicester, England  
Lille, France  
Miami, FL  
Milan, Italy  
Möglingen, Germany  
Montreal, Quebec  
Osaka, Japan  
Santa Fe Springs, CA

Other Representatives throughout  
all parts of the world.

  
Finest Quality

*Union Special*  
INDUSTRIAL SEWING EQUIPMENT