



Union Special
Industrial Sewing Equipment

STYLES ADJUSTING INSTRUCTIONS AND
ILLUSTRATED PARTS LIST

53300A

53300B

53300E

53400A

“PICOETTA” MACHINES FOR DECORATIVE EDGE STITCHING

53400B

53400E

53400K

CATALOG
NO. 228E

FIRST
EDITION

FIRST EDITION

© 1969

PRINTED 1996 IN USA

INFORMATION SUBJECT TO CHANGE WITHOUT NOTICE

© UNION SPECIAL CORPORATION ALL RIGHTS RESERVED IN ALL COUNTRIES.

This catalog applies to the standard styles of machines as listed herein.

It can also be applied with discretion to some special machines in Class 53300/400. Special Style numbers contain the letter "Z".

Example "Style 53300 EZ" etc.

Each Union Special machine carries a Style number which is stamped in the name plate on the machine. The standard Style numbers have one or more letters suffixed, but never contain the letter "Z".

Example "Style 53300 A".

Definition of Machines:

Streamlined "Picoetta" machine, enclosed oiling system, automatically lubricated and oil return pump.

- 53300 A One needle machine for single needle fagoting on brassieres, girdles, corsets, slips, nightgowns, negligees, pajamas, and similar garments made from woven fabrics.
Plain feed, needle type 8021 - 032.
- 53300 B One needle machine for making single needle Picoetta edging on handkerchiefs, pillow cases, ladies' dresses, and similar articles made from woven fabrics.
Plain feed, needle type 8021 - 032.
- 53300 E One needle machine for making single needle Picoetta edging on all knitted fabrics. Same as 53300 B, except equipped with differential feed, needle type 8021 - 032.
- 53400 A Two needle machine for double needle fagoting on ladies' undergarments, including slips, panties, nightgowns, negligees, blouses, and similar articles, made from knitted fabrics.
Differential feed, needle type 8021 - 032.
- 53400 B Two needle machine for making duplex Picoetta edging on handkerchiefs, pillow cases, ladies' dresses and similar articles made from woven fabrics.
Plain feed, needle type 8021 - 032.
- 53400 E Two needle machine for making duplex Picoetta edging on all knitted fabrics. Same as 53400 B, except equipped with differential feed, needle type 8021 - 032.
- 53400 K Combination machine for producing a variety of single and double needle fagoting and Picoetta edging operations, attaching woven or elastic braid to points of edging, or introducing elastic cord in seam structure.
Differential feed, needle type 8021 - 032.

Needles.

Standard needle for the style 53300 and 53400 is the needle type 8021. This needle is available in sizes of:

022	=	0,56	mm
025	=	0,64	mm
027	=	0,69	mm
032	=	0,81	mm
036	=	0,91	mm
040	=	1,02	mm
044	=	1,12	mm

Each Union Special needle has stamped on the shank the name "Union Special"; the type number and the size number. Collectively, type number and size number represent the complete symbol.

To have needle orders promptly and accurately filled, the empty package, or a sample needle should be sent in, or the type and size number should be specified. See marks on packages. A complete order would read:

100 Needles Type 8021, size 032.

Selection of proper needle size should be determined by size of twine used. Twine should pass freely through needle eye in order to produce a good stitch formation.

Success in the operation of this machine can be secured only with the genuine Union Special needles.

Adjusting Instructions:

Machine Styles: 53300 A, B, E
 53400 A, B, E
 53400 K.

Note: Operation direction of the machine is towards the operator.

Needle Lever stud.

Check the location of the needle lever stud in relation to the oil groove. This stud is set correctly if the arrow stamped on the front points vertically upward.

Lubrication.

Clean the machine thoroughly. As the oil was drained from the machine when shipped, the reservoir must be filled before beginning to operate. Use Gargoyle Arctic Oil C Heavy or another oil of the same quality. Be sure that the oil level is always between the red lines of the oil gauge. If the level is below the lower line, more oil is to be added. Oil all bearings and run the machine slowly for some minutes before operating at high speed. Oiling and threading diagram No. 16738 M is attached to each machine

The oil should be renewed once a year. The machine is filled with oil on the right side at the top. The drain plug screw is located below the pulley.

Setting the needle bar frame.

Remove presser foot, throat plate, and feed dog for convenient access to the mechanism.

Insert a new resp. two new needles Type 8021 - 032 and turn the needle bar until the oblique position of the needles corresponds with the vertical faces of the needle rear guard and the needles are entering centrally between the stitch tongues of the throat plate. The position of the needle bar can be altered by releasing the clamp on the connection rod and shifting the latter one slightly up or down within the respective segment. For this purpose the top cover at the right side of the machine has to be removed. The time for the lateral shift of the needles can be regulated by turning the worm located on the mainshaft. To this end the cover at the right rear portion of the machine must be removed.

Setting the looper rocker.

Adjust the clamp for the looper rocker cone stud on the looper bar so, that at its farthest point of travel to the right the distance from the left circular surface of the cone to the right circular surface of the looper drive cross shaft is $4,11/32$ ".

Looper gauge.

Adjust the loopers so that the distance from the centers of the needles to the points of the loopers is $13/64$ " when the loopers and needles are at their farthest point of travel to the right. When the loopers move to the left, their points should just contact the backs of the needles without deflecting them. When the machine is operated at speed, the clearance will be ample. The descending needles should barely touch the backs of the loopers. The looper gauge is set by swinging the looper drive lever clamped on the cross looper drive shaft. To adjust the looper avoid motion loosen the screw on the looper rocker cone stud clamp and adjust the clamp together with the loopers.

Height of needle bar.

Set the height of the needle bar so that the upper edges of the needle eyes are 0.16 " below the lower side of the loopers when the needle is at its farthest point of travel to the right. When points of loopers moving to the left they must be even with the left side of the needles.

Feed.

Assemble feed dogs and throat plate. The height of the feed dogs is correct when at their highest point of travel the teeth project above the throat plate in their full depth.

Stitch range.

Adjust the stitch length to give the desired number of stitches per inch and adjust the travel of the front differential feed to suit the fabric.

Needle guard.

Set the needle rear guard so that it barely contacts the needles at its most forward point of travel.

Cast off plate.

Set the thread cast off finger, the looper thread retaining finger, and the cast off plate so that there are equal clearances on each side of the thread take up. The flattened portion of the take up should contact the looper thread when the looper starts to the right. The looper thread should be cast off when the needle points are flush with the lower side of the loopers. The retaining finger should be set so that the Picoetta edging is of good appearance. By setting this finger higher the Picoetta looks larger and by setting it lower a smaller Picoetta will result.

Spring loop retainer.

The spring loop retainers attached to the under side of the loopers are carefully adjusted for a correct pressure. Therefore, no alteration should be made on these parts without necessity.

Threading.

Draw the threads into the machine according to the threading diagram 16738 M and start operating on a piece of fabric.

Presser foot pressure.

Regulate the presser foot spring so that it exerts just enough pressure to feed the fabric uniformly when a slight tension is placed on it.

Thread tension.

Set the tension on the needle threads as tightly as is consistent with their strength and avoid puckering the fabric. The tension on the looper threads should be barely sufficient to steady them in passing through the machine.

Frame needle thread eyelet. -

Set the frame needle thread eyelet so that the distance from the center of the holding screw to the center of the eyelet is $\frac{3}{4}$ ".

Needle thread take up wire.

Set the needle thread take up wire so that it contacts the needle threads when the needle loops are shed off the loopers.

Edge guide.

Set the fabric edge guide for the correct depth of the needle bite.

Checking the edging.

Check the edging produced by unraveling the stitches and noting if the threads are chafed or cut. If they are, apply a triangular oil stone to the feed dog teeth that are to sharp.

Instructions for adapting machine
Style 53400 K to the various kinds
of work.

- a) The original machine style 53400 K is adjusted and delivered for producing duplex Picoetta edging and is equipped with feed dog 53405 A, differential feed dog 53426 A, presser foot 79227 EA, fabric edge guide 79003 C, and screws 25 CD securing the latter. For producing the various other kinds of work some of the mentioned adjusting parts have to be removed and some others to be added as indicated in the following items.
- b) To produce single Picoetta edging omit threading of the right needle and the right looper. Otherwise the machine is the same as specified in item a).
- c) For producing duplex or single needle Picoetta edging with an elastic cord inserted in seam structure draw an elastic cord into the hole of the presser foot. Otherwise the machine is the same as specified in item a) and b).
- d) For producing double needle fagoting remove fabric edge guide 79003 C, presser foot 79227 EA, add presser foot 79220 A and a complete fabric edge guide consisting of plate 53303, guide left 53403 B, guide right 53403 A, screw 22730. Use two screws 25 CD for securing the fabric edge guide.
- e) For producing double needle fagoting with an elastic or woven braid attached to points of edging draw the braid into the slot of the right edge guide. Otherwise the machine is the same as specified in item d).
- f) For producing single needle fagoting remove the right needle, fabric edge guide 79003 C, presser foot 79227 EA, throat plate 79228 A, feed dog 53405 A, and differential feed dog 53426 A. Add feed dog 53405 K, differential feed dog 53426 K, throat plate 79224 B, presser foot 79220 K, and a complete fabric edge guide consisting of plate 53303, guide left 53403 D, Guide right 53403 C, screw 22730.
- g) For producing single needle fagoting with a woven or elastic braid attached to points of edging draw a braid into the slot of the right edge guide 53403 C. Otherwise the machine is the same as specified in item f).

**THE NEEDLE LEVER STUD
MUST BE ASSEMBLED SO**

**FILL MAIN
RESERVOIR HERE**

- ①
- ②
- ③
- ④

Union Special

**THE 1 NEEDLE - MACHINE 53300
WILL BE THREADED IN THE SAME
MANNER BY THREAD 2 AND 3**

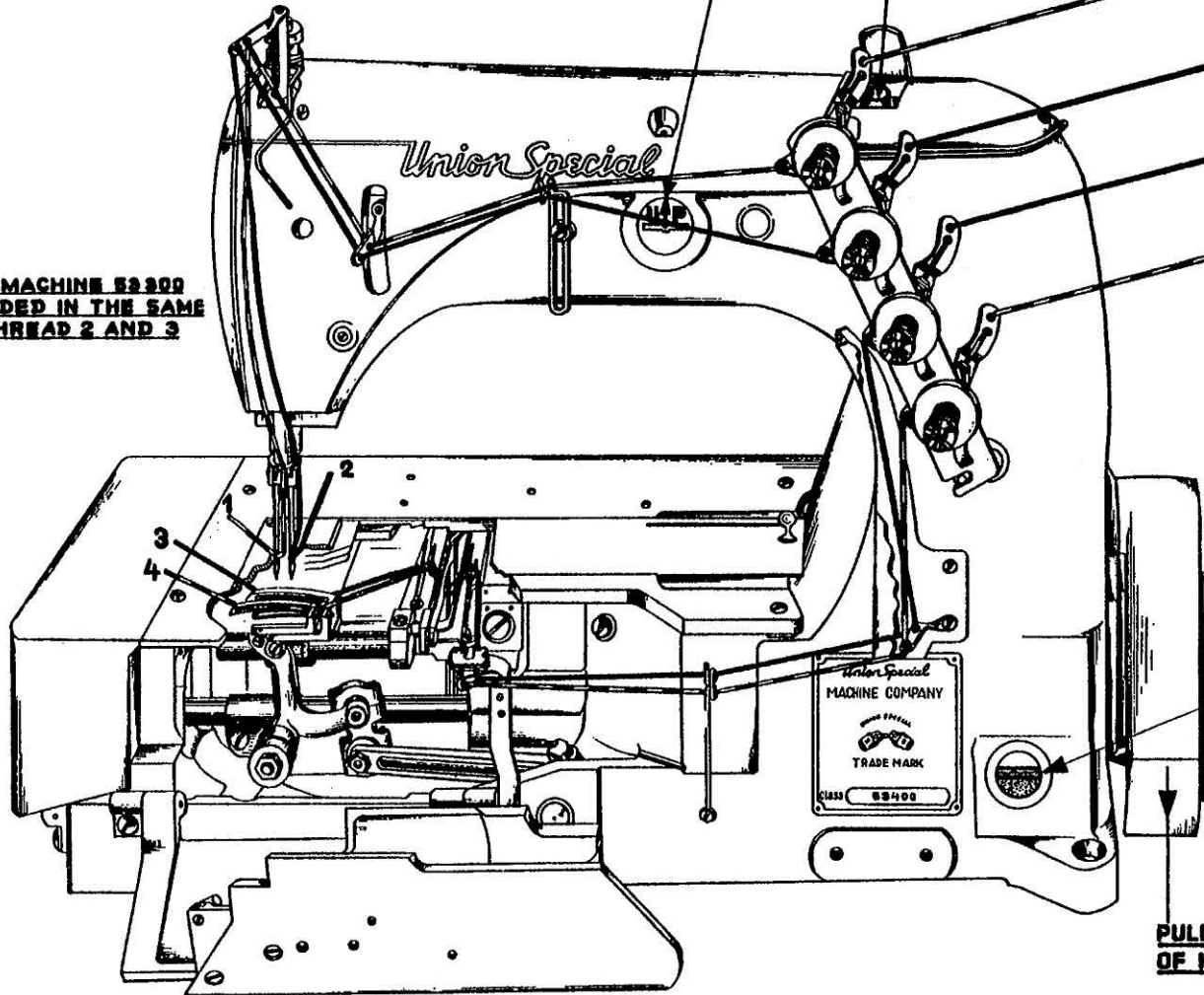

CAUTION
FILL ALL OIL RESERVOIRS BEFORE
STARTING, MACHINE HAS BEEN
DRAINED BEFORE SHIPPING.

USE AN S.A.E. 10 W STRAIGHT
MINERAL OIL.

MAIN OIL RESERVOIR GAUGE.
THE OIL LEVEL SHOULD BE KEPT
BETWEEN RED LINES.

EXCESS OIL IN MAIN RESERVOIR
MAY BE DRAINED AT PLUG SCREW
LOCATED DIRECTLY UNDER
HANDWHEEL.

**PULLING DIRECTION
OF HANDWHEEL.**

**THREADING DIAGRAM
FOR MACHINES CLASS 53300 AND 53400**

UNION SPECIAL MACHINE COMPANY

16738 M

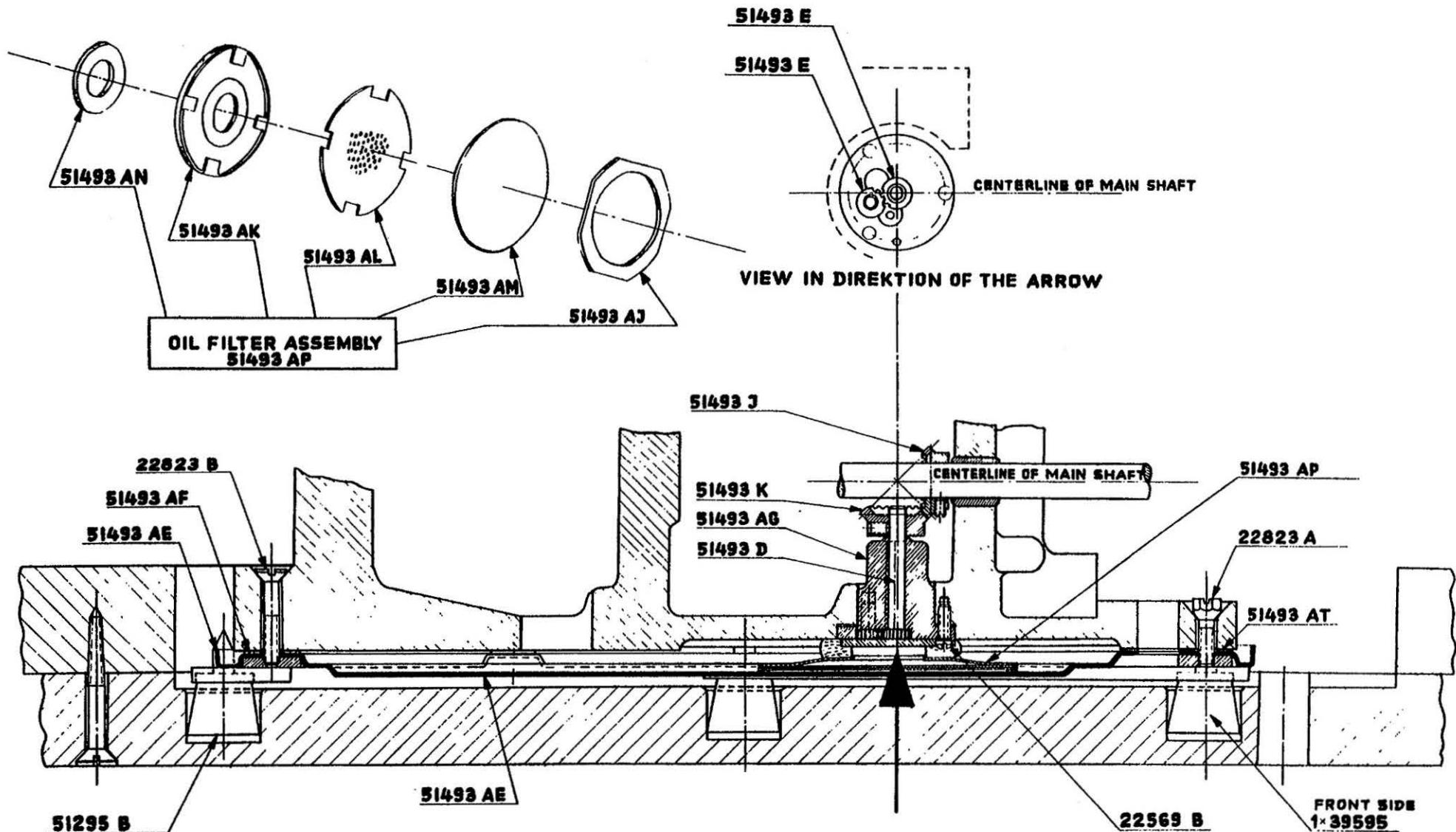

THE OIL PAN SHOULD BE REMOVED PERIODICALLY AND ANY ACCUMULATED LINT OR SIZING SHOULD BE REMOVED FROM THE FILTER ASSEMBLY BY USING AN AIR HOSE OR IMMERSING IN CARBON TETRACHLORIDE OR SOME SIMILAR SOLVENT.

CLASS 5000 WITH OIL PAN.
6 POINT ISOLATION

THREAD STAND ASSEMBLIES.

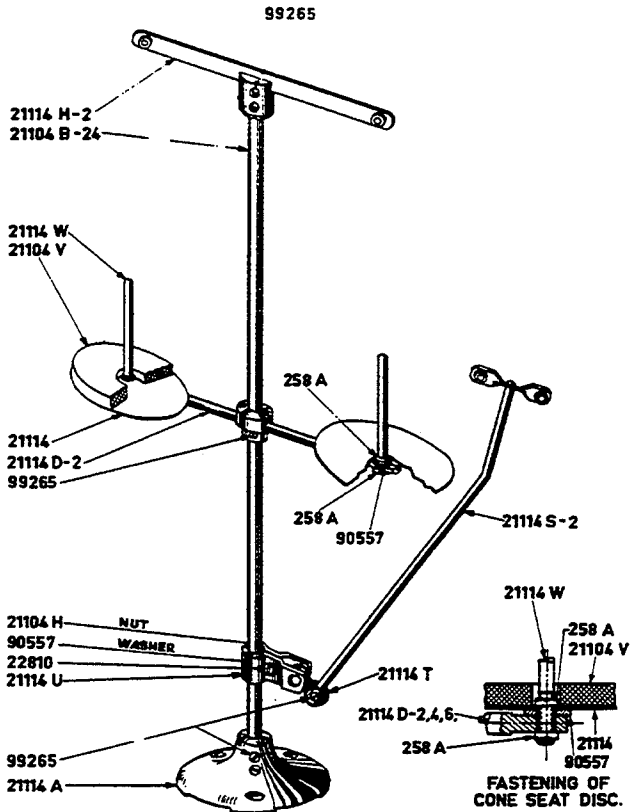

21101 H-2 (FOR 2 CONES.)

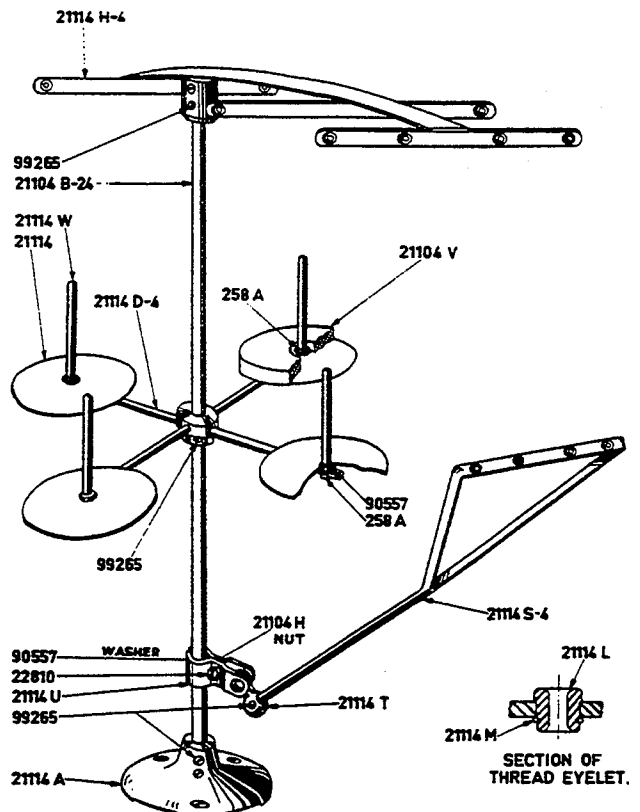

21101 H-4 (FOR 4 CONES.)

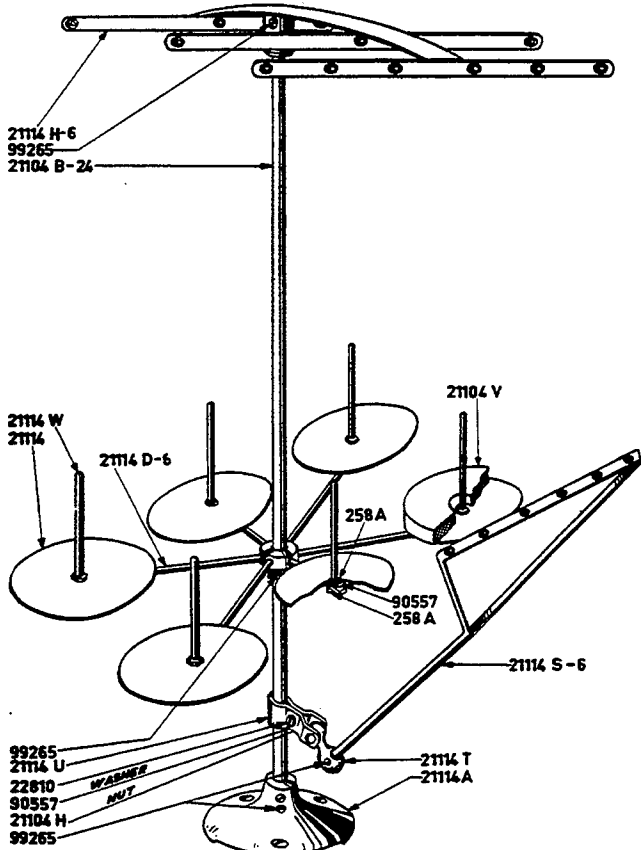

21101 H-6 (FOR 6 CONES.)

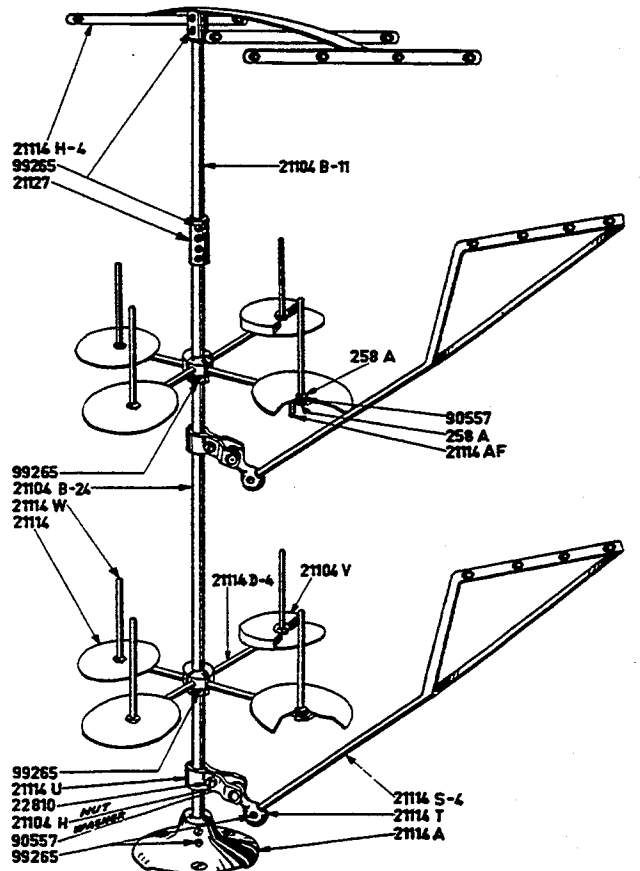

21101 P-8 (FOR 8 CONES.)

The following is a numeral list of parts used in styles 53300 and 53400. Quantities, part numbers and descriptions are given. Following the part list, there are photographs of the most parts.

Note: Numbers in parantheses following parts description indicate the screws, nuts etc.. used to attach or hold these parts.

Part No.	Plate	Description	Am. Req.
8 A	5	Feed rocker shaft	1
16	5	Feed crank ink ferrule	1
18	4	Nut, for connection rod 53341	1
20		Washer	2
	6	1 - for thread eyelet 539	
	5	1 - for feed crank stud 51236 C	
25 CD		Screw, fillister head tap No. V-130	2
	1	2 - for cloth guide holder 53303. Style 53300 A, 53400 A, K.	
	2	2 - for cloth guide 79003 C; Style 53300 B, E, 53400 B, E.	
	1	1 - for folder A 8945. Style 53300 EZ; ST 2947	
28		Screw, fillister head, tap No. V-104	5
	3	2 - for cast off plate 53304 B	
	6	2 - for looper thread eyelet 53358 C	
	7	1 - for oil guard 53394	
37 L	3	Nut, left thread for connection rod 53375	1
J 43		Looper avoid eccentric for looper avoid eccentric assembly G 29476 A (1- 96)	1
50-216 BLK		Pin for cast off plate 53357	2
50-789	-	Pin for oil cap 39582 L	1
G 50-434	6	Oil sight gauge	1
54	4	Needle lever connection link (2- linkpin 51054)	1
56		Needle clamp nut for one needle mach; Style 53300 A,B,E.	1
56 B-2		Needle clamp ring for two needle mach. (2- 88 B 56 CA) Class 53400 A, B, E, K.	1
57 WB	3	Thread tension plate for tension assembly 1287 (1- Screw 57 WL)	1
57 WC	3	Thread tension spring for tension assembly 1287 (1- screw 57 WD)	1
56 CA	3	Pin f. clamp ring 56 B-2 in n'bar 53417. Style 53400.	1

Part No.	Plate	Description	Am. Req.
57 WD	5	Shoulder screw, tap No. V-104, for plate 57 WB, spring 57 WC in tension assembly 1287.	1
73	4	Screw, fillister head, tap No. V-110	3
	3	2 - for looper	
		1 - for needle thread take up wire 53370	
73 A	1/2	Screw, fillister head, tap No. V-100	1
		1 - for spring loop retainer 53411 and 53411 A	
75	5	Screw, fillister head for feed rocker segment slot plate 52836 G, tap No. V-108	2
77	5	Screw, fillister head, tap No. V-104	3
	5	1 - for feed bar G 52834	
	4	1 - for feed rocker arm 52836 C	
		1 - for needle lever 53315	
78	4	Set screw, tap No V-109	1
		1 - for needle bar connection 53352	
79	7	Screw, fillister head, tap No. V-110	3
		3 - for crank chamber cover, upper 53382 B	
80	8	Screw, countersunk head, tap No. V-113	4
	7	2 - for clothplate 52801 D	
		2 - for throat plate support 52880	
81	3	Spot screw, tap No. V-113	1
		1 - for looper drive lever 52742 K	
87	-	Screw, countersunk head, tap No. V-107	2
		2 - for throat plates	
J 87 J	3	Screw, fillister head, tap No. V-104	5
	3	2 - for looper thread cast-off and retainer support bracket 52804 F	
	7	2 - for looper thread cast-off 53304 C	
		1 - for oil guard 53394	
88	-	Set screw, tap No. V-109	7
	3	1 - for needle bar thread tension 1287	
	3	2 - for collar 12865	
	3	1 - for shaft 53371	
	3	1 - for shaft 53371 A	
88 A	4	Screw, fillister head, tap No. V-109	2
		2 - for needle bar connection 53352	
88 B	-	Set screw, tap No. V-109	2
		2 - for needle clamp ring 56 B-2. Style 53400 A,B,E,K.	
88 D	4	Screw, fillister head, tap No. V-109	4
		4 - for cam shaft bushing 53361	

Part No.	Plate	Description	Am. Req.
90		Screw, fillister head, tap No. V-107	8
	7	2 - for spring 43281 K	
	6	3 - for oil tube holder 5289 ⁴ AB	
	-	2 - for oil drip plate 53382 D in cover 53382 B	
	-	1 - for needle lever bearing oiler 51282 AE	
91	-	Clamp screw, fillister head for presser feet. Tap No. V-107.	1
93		Screw, fillister head, tap No. V-109	2
	8	2 - for belt guard B 21375 AH	
95	-	Set screw, tap No. V-113	1
96		Spot screw, tap No. V-113	2
	-	1 - for looper avoid eccentric J 43 in assembly G 29476 A	
	-	1 - for feed lift eccentric 51406 in assembly 29476 BJ	
97 A		Screw, fillister head, tap No. V-107	10
	3	4 - for double ball bearing 15442 K	
	4	2 - for needle lever ball joint 29066 P	
	3	2 - for looper drive lever eccentric assembly G29105 A	
	4	2 - for ball joint assembly 53358	
98		Set screw, tap No. V-113	4
	-	1 - for collar 482	
	4	2 - for worm 53365	
98 A		Screw, fillister head, tap No. V-105	4
	-	1 - for thread eyelet 158 B	
	-	2 - for looper thread guard 51291 A	
	-	1 - for thread eyelet 53358 A	
	-	1 - for thread eyelet 53358 C	
109	6	Tension disc.	8
116	10	Wrench, for needle clamp nut 56	1
118 B	10	Thread tweezer	
158 B	6	Looper thread eyelet (1- screw 98 A)	1
187 B	6	Screw, fillister head for throat plate tongues	3
243	7	Cloth plate end cover spring (1- screw 22711)	1
258 A		Nut, tap No. V-118	2
	6	1 - for oil tube 660-136	
	6	1 - for looper rocker cone stud 51745	
269		Nut, left thread, tap No. V-114	2
	5	1 - for feed crank stud 51236 C	
	4	1 - for connection rod 53341	
294		Screw, fillister head	1
	3	1 - for holding cam roller assembly 53368 in frame	

53372

Part No.	Plate	Description	Am. Req.
357	-	Screw, fillister head, tap No. V-107 1 - for folder A 8056 A	1
402	4	Shoulder screw, headless, tap No. V-109 1 - for lifter lever link 53783 A in presser bar connection and guide 53385	1
421	10	Foot lift chain	1
482	5	Feed rocker shaft collar (1- screw 98)	2
531	4 9	Set screw, headless, tap No. V-109 2 - for presser bar connection and guide 53383 2 - for oil pump driven gear 51493 K	4
539	6	Needle thread eyelet, on screw 22889 A (1- 20; 1- 22848)	1
605	7	Screw, fillister head, tap No. V-102 2 - for needle frame cover 53382 F	2
643-143BLK	9	Gasket, 2 - for oil pump housing 51493 F or 1 - for oil pump housing 51493 AG	2
660-136	6	Oil tube, for feed crank link 51236 including nut 258 A	1
660 - 204	-	Oil seal ring, on main shaft, for take up	1
660-207	5	Oil seal ring, for lifter lever 51285 H	1
660-212	4	Oil seal ring 2 - for needle lever stud 51250 E (1- washer 51250 D) (1- screw 22586 R)	2
666-65	9	Oil wick, for looper shaft 53344 A	2
666-111	9	Oil wick, for feed rocker shaft 8 A	2
666-114	9	Oil wick, for crank shaft assembly G 29476 B	2
666-118	9	Oil wick, for main shaft 51222	2
666-121	-	Oil wick, in link 53345 for looper avoid eccentric assembly G 29476 A.	1
666-141	6	Oil wick, for diff. feed bar 52834 H and link 52835 T	2
666-170	-	Oil felt, for needle lever stud 51250 E	1
668-25	6	Eyelet, for thread eyelet 51292 D (1- 668-28)	8
668-28	6	Locking ring, for eyelet 668-25	8
719	4 4	Set screw, headless, tap No. V-109 1 - for needle lever stud bushing 51150 1 - for needle lever stud 51250 E	2

Part No.	Plate	Description	Am. Req.
907	5	Hexagonal nut, tap No. V-108 1 - for diff. feed regulating stud 39236 B	1
1248	5	Feed crank link shim, felt	1
HA 1286 B	3	Link pin spring, for ball 12964 C in link pin 53377 (1- screw 80090 E)	1
1287	3	Needle bar thread nipper, complete (1- screw 88)	1
G 1346 D	6	Tension post, for looper thread cast off plate 53358 C (1- nut 75255)	1
J 1614	-	Spring washer, for screw 22735	1
G 5003 A-1	-	Folder swinging arm, for folder A 8056 A (1- screw 22735; 1- spring washer J 1614)	1
A 7416 C	1	Stitch tongue, middle, marked "TL" for throat plate A 8943 (1- screw 187 B) Style 53300 EZ; ST 2947	1
A 7467 C	2	Stitch tongue, marked "TW" for throat plate 79224 K, for smaller picoetta edges. For single needle edging and fagoting with the left needle of two needle machine. (1- screw 187 B) Style 53400 K.	1
7940	3	Connection rod link, for connection rod 53375. On needle bar frame 53335 (1- link pin 51054)	1
A 7944	1	Throat plate, complete, for small picoetta edges with single needle machine. Differential feed. Main feed dog 53305 E, diff. feed dog 53326 E (2- screw 87) 3- 187 B Screw 1- 79124 EA Throat plate 1- A 7944 A Stitch tongue, middle, marked "TX" 1- A 7944 B Stitch tongue, right, marked "TY" 1- A 7944 C Stitch tongue, left, marked "TZ"	1
A 7944 A	1	Stitch tongue, middle, marked "TX" for throat plate A 7944 (1- screw 187 B)	1
A 7944 B	1	Stitch tongue, right, marked "TY" for throat plate A 7944 (1- screw 187 B)	1
A 7944 C	1	Stitch tongue, left, marked "TZ" for throat plate A 7944 (1- screw 187 B)	1
A 8056 A	-	Folder, for complete part A 8945 (1- screw 357) Style 53300 EZ; ST 2947	1
A 8943	1	Throat plate assembly with curved tongues for single needle fagotting on tulle net (2- screw 87) Style 53300 EZ; ST 2947 3- 187 B Screw 1- 79024 EA Throat plate 1- 79030 A Stitch tongue left, marked "CA" 1- A 7416 C Stitch tongue middle, marked "TL" 1- A 7944 B Stitch tongue right, marked "TY"	1

Part No.	Plate	Description	Am. Req.
A 8944	1	Presserfoot, for throat plate A 8943, for single needle fagoting on tulle net (1- screw 91) Style 53300 EZ; ST 2947	1
A 8945	1	Swingout folder, folding to the upper side, for single needle fagoting on tulle net. (1- screw 25 CD) Style 53300 EZ; ST 2947 1- 357 Screw for folder 1- J 1614 Spring washer 1- G 5003 A-1 Swingout arm 1- 22735 Shoulder screw 1- A 8056 A Folder 1- A 8945 A Holder	1
A 8945 A	-	Holder, for swingout folder A 8945 (1- screw 25 CD)	1
9255	3	Washer, for nut 53375	1
9937	3	Nut, tap No. V-109, for double ball joint 15442 K	2
12865		Collar (2- screw 88)	2
	3	1 - for front shaft 53371	
	3	1 - for needle bar frame shaft 53377	
12964 C	3	Ball 1/8' inch diameter for shaft 53377	1
12982	-	Locking nut, for screw 81	1
15430 C	4	Nut, left thread, for needle lever connection rod 51216	1
15430 D	4	Nut, right thread, for needle lever connection rod 51216	1
15442 K	3	Double ball joint, on looper rocker (2- nut 9937)	1
15445	-	Ball screw, for ball joint 53338	1
15465 F	-	Cone, for looper rocker assembly G 29192 A and B (2- screw 88)	1
21101 H-2	11	Spool stand, for two threads, style 53300	1
21101 H-4	11	Spool stand, for four threads, style 53400	1
21201	10	Screw driver, 1/8 inch blade	1
21202	10	Screw driver, 7/32 inch blade	1
G 21208	10	Screw driver set. 1- handle 3- blades 1- thread tweezer 1- oil stone	1
21225-13/64	6	Looper gauge, 13/64 inch	1
G 21227 A	6	Gauge for distance between looper rocker and looper drive lever shaft.	1

Part No.	Plate	Description	Am. Req.
B 21375	AH 8	Belt guard (2- screws 93)	1
21388	10	Wrench, 5/8 inch	1
21388	B 10	Wrench, 1/2 inch	1
21388	W 10	Wrench curved, 9/32 inch	1
21388	AN 10	Set of socket wrenches	1
21657	E 3	Washer, for 53357	1
22513	4	Screw, fillister head, tap No. V-107 2 - for presser bar connection guide G 35731 A	4
22516	5	Screw, fillister head, tap No. V-108 1 - for slot plate 52836 G	1
22517	4	Screw, fillister head, tap No. V-113 1 - for looper rocker frame 53344	1
22519	C 5	Screw, hexagonal head with slot, tap No. V-109 2 - for feed rocker connection 52836 C (1- 51235 G)	3
	5	1 - for feed dog holder 53353 (1- 51235 G)	
22524	7	Screw, countersunk head, tap No. V-107 7 - for oil reservoir top cover 53782 B	7
22528	4	Screw, fillister head, tap No. V-109 2 - for needle lever 53315	3
	3	1 - for cast off plate support 53357	
22537	5	Screw pin, tap No. V-118 1 - for presser foot lifter lever internal	1
22539	A 4	Plug screw, tap No. V-124 1 - for cam shaft 53366	2
	-	1 - for bed	
22539	C 6	Plug screw, tap No. V-126 1 - for bed on cam support.	1
22539	H -	Plug screw, tap No. V-124 1 - in bed, for looper drive lever shaft 51242 P	1
	9	1 - for oil channel in bed 53329	
22548	7	Screw, fillister head, tap No. V-113 4 - for crank chamber cover 52882 EA	4
22557	B 5	Shoulder screw, tap-No. V-113, for presser foot lifter lever crank 53783 L	1
22560	B -	Screw pin, tap No. V-109 1 - for oil tube 53394 B	1

Part No.	Plate	Description	Am. Req.
22564	8	Screw, fillister head, tap No. V-107 1 - for latch 43281 L	1
22564 D	-	Screw, fillister head, tap No. V-107 2 - for oil guard 53394 C	2
22569	5	Screw, fillister head, tap No. V-110 1 - for feed crank link 51236 (1- 35569 J)	1
22569 B	9 - 4 7	Screw, fillister head, tap No. V-110 3 - for oil pump housing 51493 F or AG 3 - for upper bushing support for cam shaft 53360 3 - for crankshaft housing 53391 and gasket 51190 D 4 - for head cover 53382	13
22569 G	9	Screw, fillister head, tap No. V-110 3 - for filter on oil pump housing 51493 F	3
22570 A	3	Screw, fillister head, tap No. V-109 3 - for bearing for needle bar rocker 53376	3
22571 A		Plug screw, tap No. V-119 A 18 - in bed 53329 for oil wicks and oil channels	18
22571 D	9	Plug screw, tap No. V-119 A 36 in bed 53329 for oil wicks and oil channels (beginning with serial No. D 80641 two screws 22571 D and one thichol replaces, 1 screw 22571 A)	36
22580	3	Screw, tap No. V-113 2 - for take up 53323	2
22585 A	7	Screw, fillister head, tap No. V-107 2 - for oil reservoir top cover 53782 B	2
22586 R	-	Screw, fillister head, tap NEF-2 1 - for oil seal ring 660-212 and washer 51250 D	1
22588 A	3	Screw, hexagonal head tap No. V-108 1 - for looper thread retainer 53304 D	1
22593	- 5	Screw, fillister head, tap No. V-104 2 - for feed dogs on holder 53353 4 - for guide plate 39237 D	6
22597	8	Spot screw, tap No. V-113 1 - for pulley 52921	1
22597 A	8	Set screw, tap No. V-113 1 - for pulley 52921	1
22645 H-64	10	Screw, hexagonal head, tap No. V-146 1 - for fixing oil pan 51493 AE on bed	1
22711	7	Screw, fillister head, tap No. V-109 1 - for endcover spring 243	1

Part No.	Plate	Description	Am. Req.
22729	5/4 3	Screw, fillister head, tap No. V-107 1 - for guide fork 51243 C 1 - for support for looper thread retainer 52804 E in 52804 F	3
22730	1/2	Screw, fillister head, tap No. V-113 1 - for fabric guide left and right 53403 A,B,C,D. 2 - for oil guard 53394 D	3
22733 B	7	Plug screw, fillister head, tap No. V-119 A 1 - for oil reservoir cover 52882 L (2- washer 41394 A)	1
22758 C	5	Shoulder screw, tap No. V-109 1 - for lifter lever link 53783 A	1
22768	5 6 6 5 4	Screw, fillister head, tap No. V-104 2 - for stitch regulating stud cap 51236 B 1 - for thread eyelet 51258 or 51458 1 - for thread eyelet 51258 A or 51458 A 1 - for needle guard holder G 52859 2 - for oil pan 53391 A	7
22795	5	Stitch regulating screw, tap No. V-107 in 51236 C	1
22799 M	7	Shoulder screw, tap No. V-109 in bed 53329 for end cover spring 243	1
22801	5	Screw, fillister head, tap No. V-104 1 - for feed crank stud 51236 C in main shaft 51222	1
22823 A	10	Screw, countersunk hexagonal head, tap No. V-146 1 - for oil pan 51493 AE	1
22823 B	10	Screw, countersunk hexagonal head, tap No. V-146 1 - for oil pan 51493 AE	1
22829	4	Screw, fillister head, tap No. V-109 1 - for looper rocker cone stud 51745	1
22839 C	8	Screw, fillister head, tap No. V-113 2 - for cloth plate 52801 D	2
22848	6 8 7	Screw, round head, tap No. V-109 1 - for thread eyelet 539 8 - for hinges 52885 G, H, J 9 - for cover for oil reservoir 52882 L	18
22849	1/2	Screw, round head, tap No. V-107 1 - for needle guard 53325 and 53425	1
22852 A	3	Screw, hexagonal head, tap No. V-113 1 - for looper drive lever 52742 K	1
22885 A	-	Plug screw, tap No. V-124 1 - in bed 53329 for looper drive lever shaft 51242 P	1

Part No.	Plate	Description	Am. Req.
22889 A	6	Adapter plug screw, with internal thread tap No. V-109 and external thread tap No. V-119 A 1 -for thread eyelet 539.	1
29066 P	4	Needle lever ball bearing assembly 1 - 52816 G Ball bearing 1 - 55243 A Ball stud	1
G 29105 A	3	Looper rocker drive eccentric assembly 1 - 51243 S Looper rocker connection 1 - 52743 A Ball stud 1 - 55343 Looper drive eccentric	1
G 29126 AA	4	Looper side step eccentric assembly 1 - 55340 Eccentric 1 - 55346 Bearing	1
G 29192 A	4	Looper rocker assembly for one needle machines Class [53300. 1 - 258 A Nut 1 - 15465 F Cone (2- 88) 1 - 22829 Screw 1 - 51745 Looper rocker cone stud 1 - 55313 Looper rocker (1- 73)	1
G 29192 B	4	Looper rocker assembly for two needle machines, Class [53400 1 - 258 A Nut 1 - 15465 F Cone (2- 88) 1 - 22829 Screw 1 - 51745 Looper rocker cone stud 1 - 55413 Looper rocker (2- 73)	1
G 29548 A	-	Needle lever assembly 1 - 54 Needle lever link 1 - 77 Screw in lever 53315 1 - 78 Screw in connection 53352 2 - 88 A Screw in connection 53352 1 - 666-203 Rivet 2 - 22528 Screw in needle lever 53315 2 - 51054 Link pin 1 - 51250 E Needle lever stud 1 - 53315 Needle lever 1 - 53352 Needle bar connection	1
29402	10	Lifter treadle assembly (2- 90561)	1
G 29476 A	4	Looper avoid eccentric assembly 1 - J 45 Eccentric 1 - 96 Screw 1 - 666-121 Wick 1 - 53345 Link	1
G 29476 B	4	Crankshaft assembly 1 - 51116 B Bearing 1 - 53322 A Crankshaft	1

Part No.	Plate	Description	Am. Req.
29476 BJ	-	Feed lift eccentric assembly	1
		1 - 43 Eccentric	
		1 - 51145 Link	
G 29476 DB	5	Differential feed assembly	1
		1 - 907 Nut	
		1 - 22516 Screw	
		1 - 29476 BJ Feed lift eccentric assembly	
		1 - 39236 B Diff. feed regulating stud	
		1 - 39236 C Diff. feed regulating stop	
		1 - 39236 V Bushing	
		1 - 39237 Diff. feed bar guide	
		1 - 51054 Link pin	
		1 - 51154 C Feed bar shaft	
		1 - 51236 Feed crank link	
		1 - 51236 A Pin	
		1 - 52834 N Nut	
		1 - G 52834 Feed bar	
		1 - 52834 H Diff. feed bar	
		1 - 52835 T Diff. feed rocker link	
		1 - 52836 Feed crank link	
		1 - 52836 C Feed rocker connection	
		1 - 52836 G Slot plate	
		1 - 52836 N Slot plate shim	
		1 - 53353 Feed dog holder	
		2 - 75 Screw for 52836 N	
		2 - 77 Screw for G 52834 and 52836 C	
		2 - 39237 D Guide plate	
		3 - 22519 C Screw for 52836 C and 53353	
		3 - 39236 A Washer for 39236 B	
		3 - 51235 G Washer for 22519 C	
		4 - 22595 Screw for 39237 D	
35178 D		Spring for oil wicks	4
	9	2 - for oil wick 666-65	
	9	2 - for oil wick 666-114	
35569 J		Nut, tap No. V-110	1
	5	1 - for screw 22569 in 51236	
G 35731 A	4	Presser bar connection guide for presser bar guide 53383 (2- screw 22513).	2
39191 G	3	Locating pin, for upper cam shaft bushing support 53360	1
39236 A	5	Washer for 39236 B in assembly G 29476 DB	3
39236 B	5	Diff. feed regulating stud for assembly G 29476 DB	1
39236 C	5	Diff. feed regulating stop in assembly G 29476 DB	1
39236 V	5	Bushing for diff. feed regulating stud in assembly G 29476 DB	1
39237	5	Differential feed bar guide (2- 22565 C) for assembly G 29476 DB.	1

Part No.	Plate	Description	Am. Req.
39237 D	5	Guide plate for diff. feed bar (2- 22593) for assembly G 29476 DB	2
G 39290 B	9	Rubber plug in bed 53329	1
39582 L	-	Oil cover, for cover over cam 53382 B	1
395 5	10	Rubber isolator with short pin 1 - for oil pan 51493 AE	1
41394 A	7	Gasket for screw 22733 B	2
45266	6	Nut, tap No. V-115 2 - for tension post 51292 G	2
5281 K	7	Spring for swinging arm 52864 P (2- 90)	1
45 81 L	8	Swinging arm latch, for 52864 P (1- screw 22564)	1
G 4 204 B	10	Oilboy	1
51054	4	Link pin, including felt wicking 2 - for needle lever link 54	4
	5	1 - for feed rocker arm 52836 C	
	3	1 - for needle bar frame 53335	
51116 B	-	Crankshaft bearing, for crankshaft G 29476 B (2- screw 22559 E)	1
51134 C	5	Feed bar shaft, for diff. feed mechanism G 29476 DB	1
51150	9	Needle lever shaft stop collar (1- screw 719)	1
51190 D	4	Housing gasket, for 53391	1
51216	4	Needle lever connection rod (1- upper nut 15430 C; 1- lower nut 15430 D)	1
51217 C	3	Needle bar, for one needle machines style 53300 (1- needle comp. nut 56)	1
51222	4	Main shaft, left section	1
51235 G	5	Washer, for screw 22519 C in diff. feed mechanism G 29476 DB	3
51236	5	Feed crank lin', (1- felt 1248; 1- screw 22569, 1- nut 35569 J) in diff. feed mechanism G 29476 DB.	1
51236 A	5	Link pin 1 - for feed lift eccentric 29476 BJ	2
	4	1 - for looper avoid eccentric G 29476 A	
51236 B	5	Stitch regulating stud cap, on main shaft 51222 (2- screw 22768)	1

Part No.	Plate	Description	Am. Req.
51236 C	5	Feed crank stud, (1- ferrule 16; 1- washer 20; 1- nut 269; 1- screw 22795)	1
51242 L	3	Looper drive lever rocker thrust washer	2
51242 M		Washer	2
	3	1 - for locking stud 52841 G	
	3	1 - for screw 22852 A in 52742 K	
51242 P	3	Looper drive lever shaft	1
51242 R	9	Looper drive lever shaft bushing, middle	1
51242 S	9	Looper drive lever shaft bushing, rear	1
51242 Z	9	Looper drive lever shaft bushing front	1
51243 C		Guide fork. (1- screw 22729)	2
	4	1 - for needle lever connecting rod upper bearing 29066 P	
	3	1 - for looper drive eccentric assembly G 29105 A	
51243 S	-	Looper lever connection bearing, for looper drive eccentric assembly G 29105 A	1
51244 M	9	Looper rock shaft bushing, middle	1
51246		Nut, tap No. V-113	1
	4	1 - for looper rocker cone stud 51745	
51250 D	-	Washer for screw 22586 R	1
51250 E	4	Needle lever stud (1- screw 719)	1
51250 F	-	Gasket, for needle lever stud (1- screw 22586 R)	1
51256 C	4	Presser bar spring	1
51256 N	4	Upper presser bar bushing, for machines with "light weight" presser bar 51257 K. Beginning with serial No. D 80641.	1
51257 K	4	Presser bar "light weight", for machines after serial No. D 80641.	1
51257 AA	9	Presser bar bushing, lower	1
51258	6	Needle lever thread eyelet, for one needle machines. Style 53300 (1- screw 22768)	1
51258 A	6	Needle bar thread eyelet, for one needle machines Style 53300 (1- screw 22768)	1
51282 AC	7	Felt in head cover 53382	1
51282 AE	6	Needle lever shaft oiler (1- screw 90)	1

Part No.	Plate	Description	Am Req.
51283 H	5	Presser foot lifter le er	1
51290 R	9	Crankshaft housing bushing	1
51290 T	9	Main shaft bushing, middle	1
51291 A	8	Looper thread guard (2- screw 98 A)	1
51292 A	6	Tension post ferrule, for 51292 G	4
51292 C	6	Tension regulating nut	4
51292 D	6	Tension post thread eyelet	4
51292 F-2	6	Looper thread tension spring, .022 inch dia. wir	2
51292 F-8	6	Needle thread tension spring, .037 inch dia. wire	2
51292 G	6	Tension post	4
51295 B	10	Rubber insulator 4 - for machines without oil pan 5 - for machines with oil pan	5
G 51321 D	-	<u>Discontinued</u> , pulley, replaced by 52921	-
51458	6	Needle lever thread eyelet, for two needle mach Style 53400 (1- screw 22768)	1
51458 A	6	Needle bar thread eyelet for two needle mach. Style 53400 (1- screw 22768)	1
51491 C	6	Lead in thread eyelet	4
51493 A	9	Cover for oil pump housing 51493 F, for machines till serial No. 589053.	1
51493 D	9	Pump driving shaft	1
51493 E	9	Pump driving shaft gear	2
51493 F	9	Oil pump housing and filter cap assembly, for machines till serial No. 589053	1
51493 J	-	Pump driving gear (2- screw 531)	1
51493 K	9	Pump driven gear (2- screw 531)	1
51493 S	9	Strainer, for oil pump housing and filter cap assembly 51493 F.	1
51493 T	9	Oil filter cup, for machines till serial No. 589053	1
51493 AA	9	Oil filter bag and spring assembly, for machines till serial No. 589053.	1

Part No.	Plate	Description	Am. Req.
51493 AB	9	Gasket, for oil filter cup 51493 T	1
51493 AE	-	Oil pan with six point insulation. For mach. beginning with serial No. D 80641. (Each 1 screw 22823 A, 22823 B, 22645 H-64) (oil filter 51493 AF)	1
51493 AF	-	Insulating washer for oil pan 51493 AE	3
51493 AG	9	Oil pump housing for machines with oil pan. Beginning with serial No. D 80641.	1
51493 AH	9	Cover for oil pump housing 51493 AG. For mach. with oil pan. Beginning with serial No. D 80641.	1
51493 AP	-	Oil filter assembly, for machines with oil pan 51493 AE. Beginning with serial No. D 80641.	1
51745	-	Looper rocker cone stud for looper rocker assembly 29192 A and B	1
51785	9	Spring for oil wick 666-111	2
51959 B	6	Looper thread nipper disc for looper thread eyelet 53358 C.	2
51959 C	6	Tension spring, for looper thread eyelet 53358 C	1
51959 D	6	Tension nut, for looper thread eyelet 53358 C	1
52742 K	3	Looper drive lever. (1- washer 51242 M; 1-screw 22852 A)	1
52743 A	-	Ball stud, for looper drive eccentric assembly G 29105 A	1
52801 D	8	Cloth plate. (each 2- screw 80; 22839 C)	1
52802 C	8	Cloth plate sliding cover right	1
52804 E	3	Support for looper thread retainer 52804 F (1- screw 22729)	1
52804 F	3	Looper thread cast-off and retainer support bracket (2- screw J 87 J)	1
52816 G	-	Needle lever ball bearing for ball bearing assembly 29066 P	1
G 52834	5	Main feed bar, for diff. feed mechanism G 29476 DB	1
52834 H	5	Differential feed bar, for diff. feed mechanism G 29476 DB.	1
52834 N	5	Hexagonal nut, tap No. V-108 1 - for differential feed regulating stud 39236 B	1
52835 T	5	Differential feed bar driving link, for diff. feed mechanism G 29476 DB.	1

Part No.	Plate	Description	Am Re:
52856	5	Feed rocker, for diff. feed mechanism G 29476 DB	1
52856 C	5	Feed rocker arm, for diff. feed mechanism G 29476 DB (2- washer 51235 G; 2- screw 22519 C)	1
52856 G	5	Feed rocker segment slot plate, for diff. feed mechanism G 29476 DB (1- screw 22516; 2- screw 75)	1
52856 N	5	Feed rocker segment slot plate shim, for diff. feed mechanism G 29476 DB. (1- screw 22516; 2- screw 75)	1
52856 P	9	Feed rocker shaft bushing	2
52856 R	9	Looper rocker shaft bushing, left	1
52841 G	3	Looper drive ball joint locking stud, for 52742 K (1- washer 51242 M, 1- nut 52841 J)	1
52841 H	-	<u>Discontinued</u> , nut, replaced by 52841 J	-
52841 J	3	Circular nut, tap No. V-113 1 - for locking stud 52841 G	1
52848 E	-	Ball bearing, for ball joint 53538	1
G 52859	5	Support for needle guard (1- screw 22768)	1
52864 P	8	Front plate hinged bracket. (1- hinge 52885 G; 1- hinge 52885 H; 4- screw 22848)	1
52880	7	Throat plate support, (2- screw 80)	1
52882 K	7	Gasket, for cover 53782 B	1
52882 L	7	Oil reservoir back cover (9- screw 22848)	1
52882 M	7	Gasket, for cover 52882 L	1
52882 U	7	Gasket, for cover 52882 AE	1
52882 AC	-	Spring, for oil cap 39582 L on 52882 AD	1
52882 AE	7	Crank chamber cover (4- screw 22548)	1
52883 R	9	Presser foot lifter lever extension bushing, for lifter lever 51283 H.	1
52883 S	5	Presser foot lifter lever bell crank spring, for 53785 L.	1
B 52885 A	8	Cloth plate end cover, (each one hinge 52885 G; 52885 J; 4- screws 22848)	1
52885 G	8	Cloth plate end cover hinge, front, also right hinge for No. 52864 P (2- screw 22848)	2
52885 H	8	Front plate hinged bracket hinge, left (2- screw 22848)	1

Part No.	Plate	Description	Am. Req.
52885 J	8	Cloth plate end cover hinge, rear. (2- screw 22848)	1
52888 A	4	Presser bar, for machines till serial No. 589053	1
52889 A	4	Presser bar bushing, upper, and presser spring regulator, for machines till serial No. 589053	1
52890 C	9	Main shaft bushing, left, and inner right	2
52894 AB	6	Oil tube holder (1- screw 90) 1 - for oil tube 52894 AD 1 - for oil tube 52894 AE 1 - for oil tube 53394 A	3
52894 AD	6/9	Differential feed bar shaft oil tube (1- screw 90)	1
52894 AE	6/9	Differential feed bar guide oil tube (1- screw 90)	1
52921	8	Pulley, working diameter 2 1/2 inch (1- screw 22597; 1- 22597 A)	1
53303	1/2	Edge guide support, for edge guide 53303 A and B 53403 A, B, C, D. (2- screw 25CD) Mach. style 53300 A, 53400 and K.	1
53303 A	1	Edge guide, right (1- screw 22730) Mach. style 53300 A	1
53303 B	1	Edge guide, left. (1- screw 22730) Mach. style 53300 A	1
53304 B	3	Cast-off plate. (2- screw 28)	1
53304 C	3	Looper thread cast-off (2- screw J 87 J)	1
53304 D	3	Looper thread retainer (1- screw 22588 A)	1
53305 A	1	Feed dog, for throat plate 79124 A (2- screw 22593) Mach. style 53300 A.	1
53305 B	1	Feed dog, for throat plate 79124 B (2- screw 22593) Mach. style 53300 B.	1
53305 E	1	Main feed dog, for throat plate 79124 E (2- screw 22593) diff. feed dog 53326 E. Mach. style 53300 E	1
53313	4	Looper rocker, for looper rocker assembly G 29192 A. One needle machines style 53300 (1- screw 73)	1
53315	4	Needle lever, for needle lever assembly G 29348 A	1
53322 A	4	Crankshaft, for crankshaft assembly G 29476 B	1
53323	3	Looper thread double disc tape up (2- screw 22580)	1
53325	1	Needle guard marked "TT", for one needle machines. Needle guard support G 52859 (1- screw 22849)	1

Part No.	Plate	Description	Am. Req.
53326 E	1	Differential feed dog, for throat plate 79124 E (1- screw 90) Main feed dog 53305 E. Machine style 53300 E.	1
53335	3	Needle bar frame 53335 A including two bushings 53354. (1- screw 22743 for link pin; 1- screw 22596 for shaft)	1
53338	4	Looper side step ball joint complete 1 - for 15443 Ball stud 1 - for 53344 F Washer 1 - for 52848 E Ball bearing	1
53340	-	Eccentric bearing for looper side step eccentric assembly G 29126 AA.	1
53341	4	Connection rod 3 25/32 inches long, for looper side step (1- nut 18; 1- nut 269)	1
53342	3	Looper drive lever rocker including screw 99239	1
53343	-	Looper drive eccentric, for looper drive eccentric assembly G 29105 AA.	1
53344	4	Looper rocker frame (1- screw 22517)	1
53344 A	4	Looper rock shaft	1
53344 B	4	Looper rock shaft and side step arm. (each one screw 77, 93, 22764 ball joint assembly 53338)	1
53344 C	9	Looper rock shaft bushing, right.	1
53344 F	3	Fibre washer, for ball joint assembly 53338	1
53345	-	Link, for looper avoid eccentric assembly G 29476 A	1
53346	-	Eccentric for looper side step eccentric assembly G 29126 AA.	1
53352	4	Needle bar connection (2- screw 88 A; 1- screw 78) for needle lever assembly G 29348 A.	1
53353	5	Main feed dog holder block (1- screw 22519 C, 1- washer 51235 G) for differential feed mechanism G 29476 DB.	1
53354	3	Needle bar bushing	2
53357	3	Cast-off support plate (1- screw 22528; 1- washer 21657 E)	1
53358	6	Looper thread eyelet, for looper thread tension compl. 53358 C.	1
53358 A	6	Looper thread eyelet (1- screw 98 A)	1

Part No.	Plate	Description	Am. Req.
53358 B	6	Looper thread tension holder, for looper thread tension, complete 53358 C.	1
53358 C	6	Looper thread tension and eyelet, complete 2 - 28 screw for 53358 B 1 - G 1346 D tension post 2 - 51959 B tension disc 1 - 51959 C tension spring 1 - 53358 looper thread eyelet 1 - 53358 B looper thread tension holder 1 - 75255 nut.	1
53360	3	Upper cam shaft bushing support, including bushing 53362 (3- screw 22569 B)	1
53361	4/9	Lower cam shaft bushing (1- gasket 53361 A; 4- screw 88 D; 1- plug screw 22539 A)	1
53361 A	7	Copper gasket, for lower cam shaft bushing 53361	1
53362	9	Upper cam shaft bushing in bushing support 53360	1
53363	3	Circular nut, for spacer 53363 A	1
53363 A	3	Spacer, for cam (circular nut 53363)	1
53364	8	Front cover plate, on cover plate support hinged bracket 52864 P. (2- 93 A)	1
53365	4	Worm, steel, for worm gear 53365 A, 5 left threads.	1
53365 A	4	Worm gear, aluminum-bronze, 30 teeth, for worm 53365	1
53366	4	Cam shaft, for cam 53367	1
53367	4	Cam, for one- and two- needle picoetta stitching (1- screw 88; 1- screw 22764)	1
53368	3	Cam roller assembly, for cam 53367 1 - 53368 A cam roll 1 - 53369 cam roll stud (1- screw 294)	2
53368 A	-	Cam roll, for cam roller assembly 53368	2
53369	-	Cam roll stud, in needle bar frame rocker 53372	2
53370	6	Take up wire, in needle bar frame 53355. (1- screw 75)	1
53371	3	Needle bar frame rocker and cam shaft bushing, front shaft	1
53371 A	3	Needle bar frame rocker and cam shaft bushing, rear shaft	1
53372	3	Needle bar frame rocker (1- screw 294)	1

Part No.	Plate	Description	Am. Req.
53373	3	Nut, circular head, with shoulder, for slot in needle bar frame rocker 53372 (1- bushing 53373 A; 1- screw 99520)	1
53373 A	3	Bushing, for slot in needle bar frame rocker 53372 (1- nut 53373; 1- screw 99520)	1
53374	3	Connection rod link, right, (1- screw 22585).	1
53375	3	Connection rod, for needle bar, frame. (Link right 53374, link left 7970, 1- nut 37 L)	1
53376	3	Needle bar frame shaft bearing (3- screw 22570 A; 2- pin 79041)	1
53377	3	Needle bar frame shaft assembly 1 - 53377 A shaft 1 - HA 1286 B Spring 1 - 12964 C ball 1 - 80090 E screw	1
53377 A	-	Needle bar frame shaft, for assembly 53377	1
53382	7	Head cover. (Gasket 53382 A; 3- screw 22569 B)	1
53382 A	7	Gasket, for head cover 53382	1
53382 B	7	Cover, over cam, complete. (3- screw 79) 1 - 50-787 Pin for oil cover 2 - 90 screw 1 - 39582 L oil cover 1 - 52882 AC spring 1 - 53382 D baffle plate 1 - 53382 E cover	1
53382 C	7	Gasket, for cover 53382 B	1
53382 D	-	Baffle plate, for cover complete No. 53382 B (2- screw 90)	1
53382 E	-	Cover, for cover complete No. 53382 B	1
53382 F	7	Needle bar frame cover (2- screw 605)	1
53383	4	Presser bar guide, for machines with or without "Light weight; parts (2- screw 531; 2- screw 402)	1
53391	9	Crank shaft bushing housing, including bushing 51290 R.	1
53391 A	4	Oil pan, for worm, on housing 53391 (2- screw 22768)	1
53394	7	Thread guard and oil drip plate, on cast-off support plate 53357. (1- screw J 87 J)	1
53394 A	6/9	Oil tube, for feed lift eccentric.	1

Part No.	Plate	Description	Am. Req.
53394 B	6/9	Oil tube, for looper rocker and double ball joint 15442 E.	1
53394 C	.	Oil guard, on 52894 AB (2- screw 22564 D)	1
53394 D	-	Oil guard, for looper rocker connection double ball joint (2- screw 22730)	1
53403 A	2	Edge guide, right, and braid guide, for double needle fagoting. Mach. style 53400 A and K. (1- screw 22730)	1
53403 B	2	Edge guide, left, for double needle fagoting (1- screw 22730). Mach. style 53400 A and K.	1
53403 C	2	Edge guide, right, and braid guide, for one needle fagoting with the left needle of two needle mach. Mach. style 53400 K (1- screw 22730)	1
53403 D	2	Edge guide, left, for one needle fagoting with the left needle of two needle machines style 53400 K. (1- screw 22730)	1
53405 A	2	Main feed dog, for throat plate 79228 A (2- screw 22593) Diff. feed dog 53426 A, presser foot 79227 B. Mach. style 53400 A.	1
53405 B	2	Feed dog, for throat plate 79224 A (2- screw 22593) Mach. style 53400 A.	1
53405 E	2	Main feed dog, for throat plate 79224 E (2- screw 22593) Diff. feed dog 53426 E, presser foot 79227 E. Mach. style 53400 E.	1
53405 K	2	Main feed dog, for throat plate 79224 K (2- screw 22593) Diff. feed dog 53426 K. Mach. style 53400 K.	1
53407	2	Front looper, complete 1 - 53407 C looper 1 - 53411 retaining spring 1 - 73 A screw Mach. style 53400.	1
53407 C	2	Front looper, for looper complete 53407. Mach. style 53400.	1
53409	1/2	Rear looper, complete, also for one needle machines. 1 - 53409 C looper 1 - 53411 A retaining spring 1 - 73 A screw Mach. style 53300/400	1
53409 C	1/2	Rear looper, for looper complete 53409. Mach. style 53300/400	1
53411	2	Thread retaining spring, marked "TK", for looper 53407 (1- screw 73 A) Mach. style 53400.	1

Part No.	Plate	Description	Am. Req
53411 AC	1/2	Thread retaining spring, marked "TL", for looper 53409. (1- screw 75 A) Mach. style 53300/400	1
53415	-	Looper rocker, for looper rocker assembly G 29192 B. Two needle machine style 53400 (2- screw 75)	1
53417	5	Needle bar, marked "UC" for two needle machine style 53400	1
53425	2	Needle guard, marked "TU" for two needle machines, style 53400. Needle guard support G 52859. (1- screw 22849)	1
53426 A	2	Differential feed dog, for throat plate 79228 A. (1- screw 90) Main feed dog 53405 A. Machine style 53400 A and K.	1
53426 E	2	Differential feed dog, for throat plate 79224 E. (1- screw 90) Main feed dog 53405 E. Mach. Style 53400 E.	1
53426 K	2	Differential feed dog, for throat plate 79224 K. (1- screw 90) Main feed dog 53405 K. Mach. style 53400 K	1
53458	5	Thread separator, for two looper threads, between take-up and loopers. (1- screw J 87 J)Mach.style 53400.	1
53592	6	Tension post support, 4 tensions, mach. style 53400	1
53782 B	7	Oil reservoir top cover.(7- screw 22524; 2- screw 22585 A)	1
53785 A	5	Lifter lever link, (1- screw 402; 1- screw 22758 C)	1
53785 L	5	Presser foot lifter lever crank (1- screw 22557 B)	1
53783 M	5	Lifter lever connection rod.	1
53783 N	5	Presser foot lifter lever, internal	1
55245 A	-	Ball stud, for needle lever ball bearing assembly 29066 P.	1
75255	6	Hexagonal nut, tap No. V-107 1 - for tension post G 1346 D.	1
79005 C	1/2	Edge guide, (2- screw 25 CD) Mach. style 53300 B, E, 53400 B, E and K.	1
79020 A	1	Presser foot, with sectional yielding bottom, for joining two pieces of fabrics, fagoting effect. Mach. style 53300 A. Throat plate 79124 A, feed dog 53305 A.	1

Part No.	Plate	Description	Am. Req.
79020 BB	1	Presser foot, rigid bottom, with yielding section on right side. One needle mach. style 53300 B. Throat plate 79124 B, feed dog 53305 B.	1
79027 E	1	Presser foot, hinged bottom, for edging knitted or other elastic fabrics. One needle mach style 53300 E Throat plate 79124 E, feed dog 53305 E and 53326 E.	1
79030 A	1	Stitch tongue, center and left, marked "CA" ^{NOT} for throat plates 79124 A, 79124 B, 79124 E and A 8945 (1- screw 187 B)	2
79030 B	1	Stitch tongue, right, marked "CB" ^{NOT} for throat plate 79124 B. (1- screw 187 B)	1
79030 E	1	Stitch tongue, right, marked "CE" ^{NOT} for throat plate 79124 A (1- screw 187 B)	1
79030 EA	1	Stitch tongue, right, marked "CH" for throat plate 79124 E. (1- screw 187 B)	1
79041 - 1	3	Needle bar frame shaft bearing locating pin.	2
79124 A	1	Throat plate assembly, for one needle fagoting, plain feed, feed dog 53305 A (2- screw 87) 3 - 187 B screw 2 - 79030 A stitch tongue, center and left, marked "CA" 1 - 79030 E stitch tongue, right, marked "CE" 1 - 79124 AA throat plate Mach. style 53300 A.	1
79124 B	1	Throat plate assembly, for one needle picoetta edging, plaine feed, feed dog 53305 B (2- screw 87) 3 - 187 B screw 2 - 79030 A stitch tongue, center and left, marked "CA" 1 - 79030 B stitch tongue, right, marked "CB" 1 - 79124 BA throat plate Machine style 53300 B.	1
79124 E	1	Throat plate assembly, for one needle picoetta edging on elastic fabrics. Differential feed, feed dog 53305 E, diff. feed dog 53326 E. (2- 87) 3 - 187 B screw 2 - 79030 A stitch tongue, center and left, marked "CA" 1 - 79030 EA stitch tongue, right, marked "CH" 1 - 79124 EA throat plate	1
79220 A	2	Presser foot assembly, with left, middle and right yielding sections, for hemstitching on two needle diff. feed machines. Throat plate 79228 A, feed dog 53405 A, diff. feed dog 53426 A. (1 screw 91) Machine style 53400 A and K.	1

Part No.	Plate	Description	Qty Req.
79220 K	2	Presser foot assembly, with left yielding section, for hemstitching only with the left needle on two needle differential feed machines. (1- screw 91) Machine style 55400 k.	1
79224 B	2	Throat plate assembly, for duplex picoetta edging, plain feed, feed dog 55405 B (2- screw 87) 4 - 187 B screw 1 - 79224 BA throat plate 2 - 79250 A stitch tongue, left, marked "TF" 1 - 79250 B stitch tongue, center, marked "TG" 1 - 79250 C stitch tongue, right, marked "TH" Machine style 55400 B.	1
79224 E	2	Throat plate assembly, for duplex picoetta edging on elastic fabrics. Differential feed, feed dog 55405 E, diff. feed dog 55426 E (2 screw 87) 4 - 187 B screw 1 - 79224 EA throat plate 2 - 79250 A stitch tongue, left, marked "TF" 1 - 79250 B stitch tongue, center marked "TG" 1 - 79250 E stitch tongue, right, marked "TQ". Machine style 55400 E.	1
79224 K	2	Throat plate assembly, for picoetta edging and fagoting only with the left hand needle of two needle machines. Differential feed, feed dog 55405 k, diff. feed dog 55426 k (2- screw 87) 1 - 187 B screw 1 - 79224 KA throat plate 1 - 79250 k stitch tongue, marked "TQ" Machine style 55400 k.	1
79227 B	2	Presser foot, hinged, for duplex picoetta edging on machines with plain feed (1- screw 91) throat plate 79224 B. Mach. style 55400 B.	1
79227	2	Presser foot, hinged, for duplex picoetta edging on machines with differential feed (1- screw 91) Throat plate 79224 E. Mach. style 55400 E.	1
79227 EA	2	Presser foot, hinged bottom with hole and guide, for duplex picoetta edging and insert an elastic cord in seam structure. (1- screw 91) Throat plate 79224 E or 79228 A. Mach. style 55400 E or K.	1
79228 A	2	Throat plate assembly, for double needle fagoting on machines with differential feed. Feed dog 55405 A, diff feed dog 55426 A. (2- screw 87) 2 - 187 B screw 1 - 79250 D stitch tongue, right, marked "TN" 1 - 79250 G stitch tongue, left, marked "TT" 1 - 79250 H stitch tongue, center, marked "TU" 1 - 79228 AA throat plate	1

Part No.	Plate	Description	Am. Req.
79230 A	2	Stitch tongue, left, marked "TF" for throat plates 79224 B and 79224 E. (1- screw 187 B)	2
79230 B	2	Stitch tongue, center, marked "TG" for throat plates 79224 B and 79224 E. (1- screw 187 B)	2
79230 C	2	Stitch tongue, right, marked "TH" double prong, for throat plate 79224 B. (1- screw 187 B)	1
79230 D	2	Stitch tongue, right, marked "TN" double prong, for throat plate 79228 A (1- screw 187 B)	1
79230 E	2	Stitch tongue, right, marked "TQ" double prong, for throat plate 79224 E. (1- screw 187 B)	1
79230 F	-	Stitch tongue, marked "TS" for throat plate 79224 B, for one needle picoetta edging on two needle machine, similar to 79030 B but shaft 5/32 inch longer. (1- screw 187 B)	1
79230 G	2	Stitch tongue, left, marked "TT" double prong, for throat plate 79228 A (1- screw 187 B)	1
79230 H	2	Stitch tongue, center, marked "TU" for throat plate 79228 A. (1- screw 187 B)	1
79230 K	2	Stitch tongue, marked "TO" for throat plate 79224 K. For single needle edging and fagoting only with the left needle of two needle diff. feed machines. (1- screw 187 B) Machine style 53400 K.	1
80090 E	3	Screw with oil hole, in needle bar frame shaft 53377.	1
80699 B	3	Dowel pin, for 53360	1
90561	10	Wood screw, for threadle lifter 29402	2
90562	10	Wood screw, for thread stand 21101 II-2 and II-4.	4
99239	3	Hexagonal screw 1 - for looper drive lever 53342	1
99520	3	Hexagonal screw 1 - for needle bar frame rocker slot plate 53373.	1



79020 A



79020 BB



79027 E



A 8944



79124 A

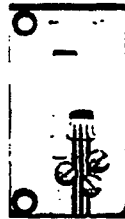

79124 B

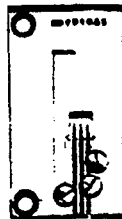

79124 E



A 7944



A 8943



79030 A

79030 E

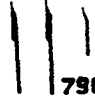

79030 A

79030 B



79030 A

79030 EA



A 7944 C

A 7944 B

A 7944 A



79030 A

A 7944 B

A 7416 C



53305 A



53305 B



53305 E

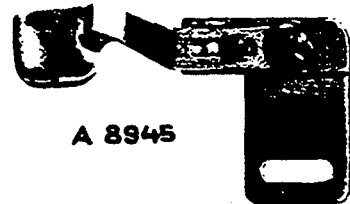

A 8945



53326 E



53325



22849



53409



53409 C

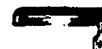

53411 A

73 A



53303 B

53303 A



25 CD



22730



53303

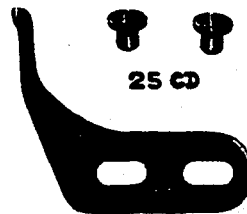

79003 C

25 CD

2

2

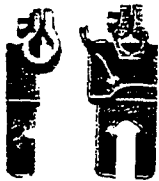

79220 K
79227 EA



79220 A



79227 B



79227 E



79224 K



79224 A



79224 B

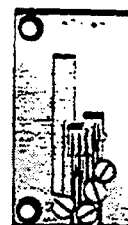

79224 E

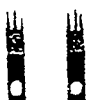

79230 K

A7487 C



79230 H
79230 G

79230 D

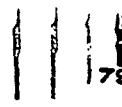

79230 A

79230 C
79230 B



79230 A
79230 B
79230 E



53405 K



53405 A



53405 B



53405 E



53426 K

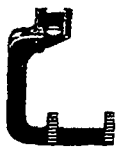

53426 A



53426 E

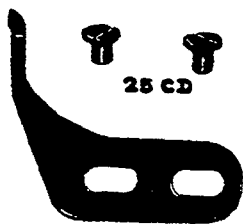

25 CD

79003 C



53403 D



53403 C



53403 B



53403 A

25 CD

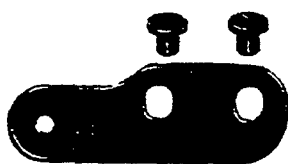

53303



53425

22849



53407



53408



22730



53407 C



53411



73 A



53409 C



53411 A

73 A

3

3

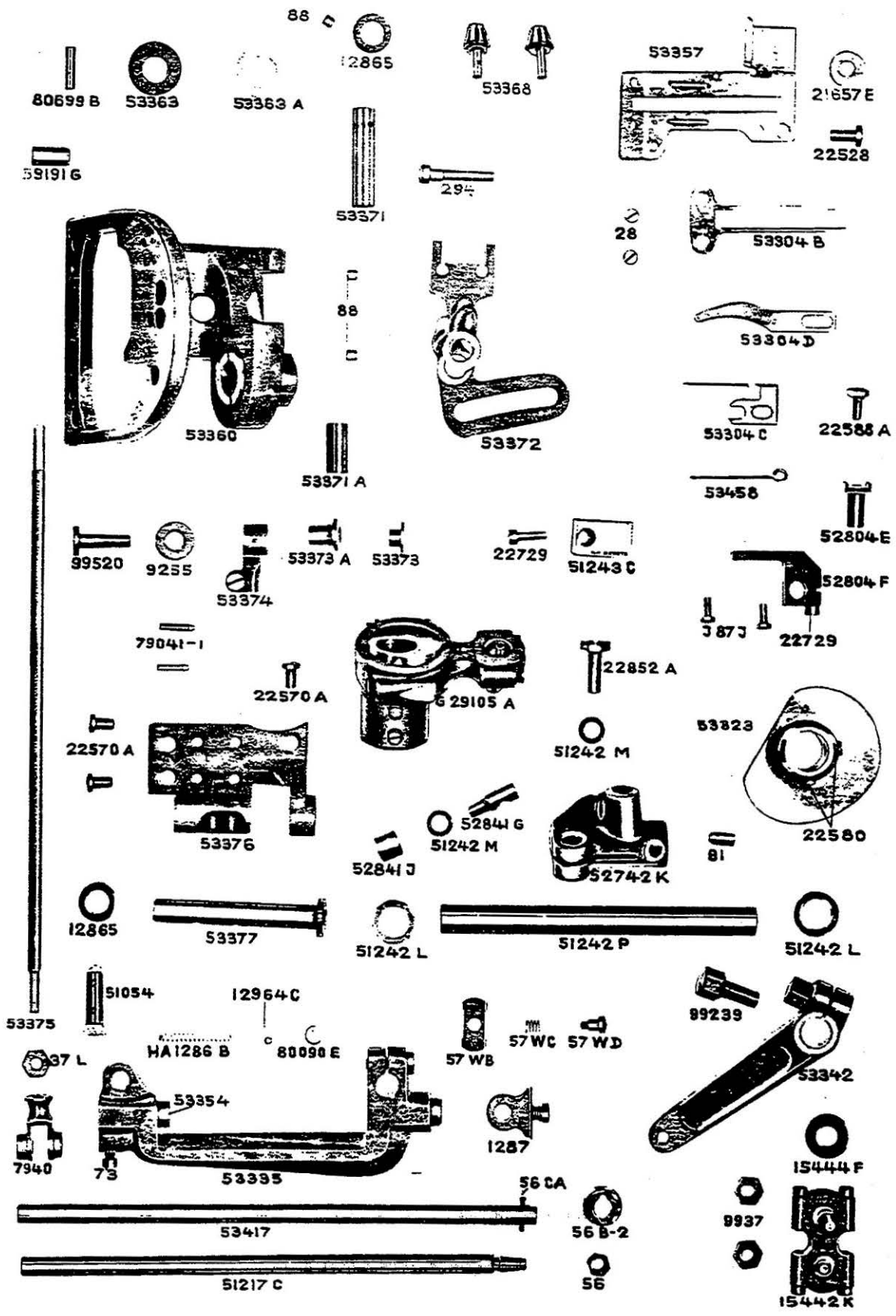

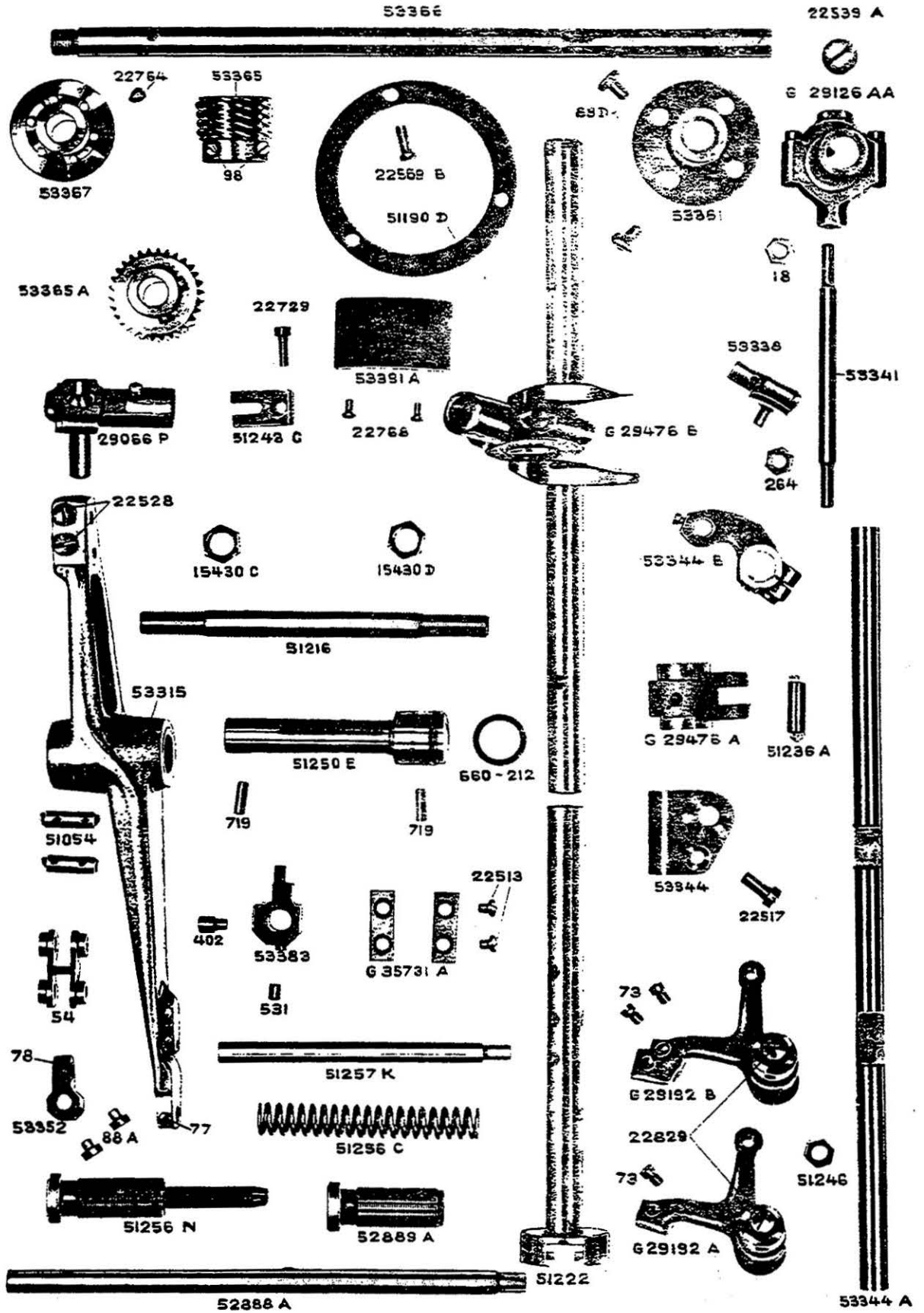

5

5

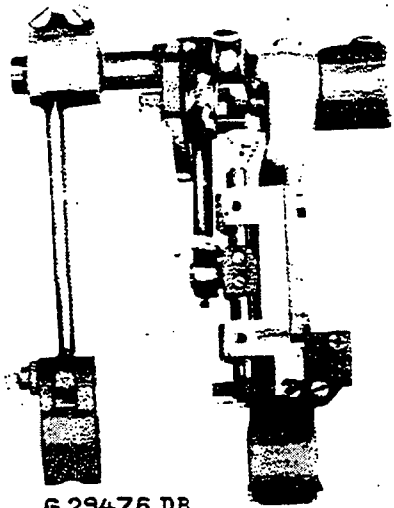

G 29476 DB



482



8 A

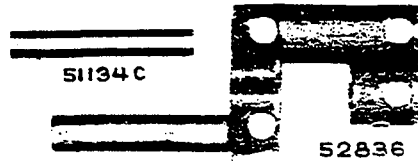

51134 C

52836

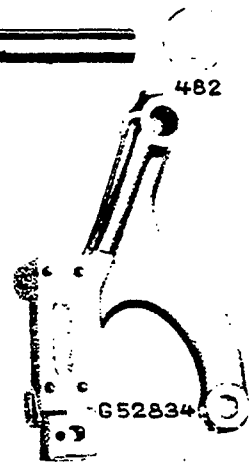

482

G 52834



22516



22593



53353

51235 G



22519 C



52836 N



52834 N



52836 G

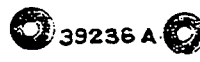

39236 A



77

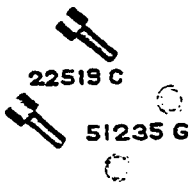

22519 C

51235 G

52836 C

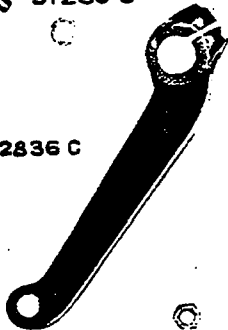

75



39237



52835 T

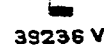

39236 V

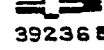

39236 B

907

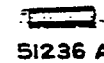

51236 A



51054



51236

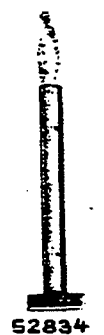

52834

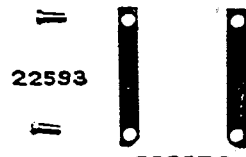

22593

39237 D



29476 BJ

77



35569 J



1248



22569



22795



51236 B



22768



G 52859



22849



22768



269



20



16



51236 C



22801

660-207

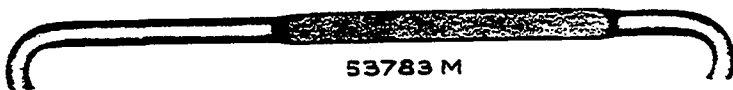

53783 M



53783 A



22758 C

53783 L



52883 S



22557 B



22537

53783 N



51283 H

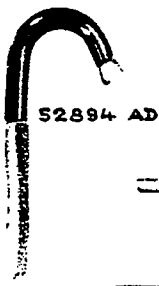
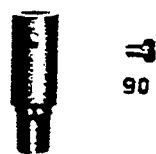
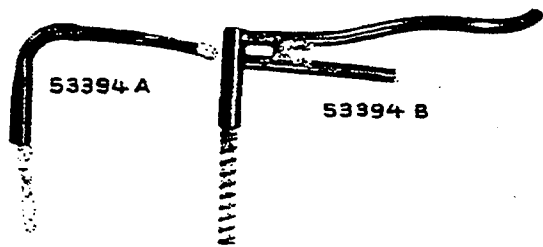
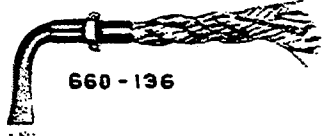
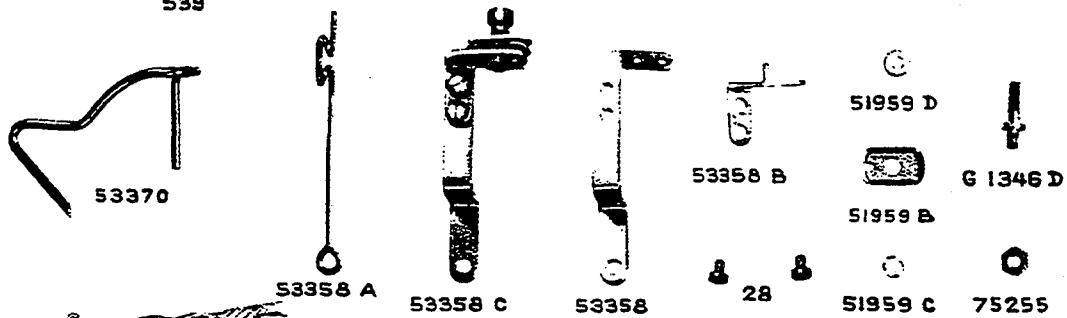
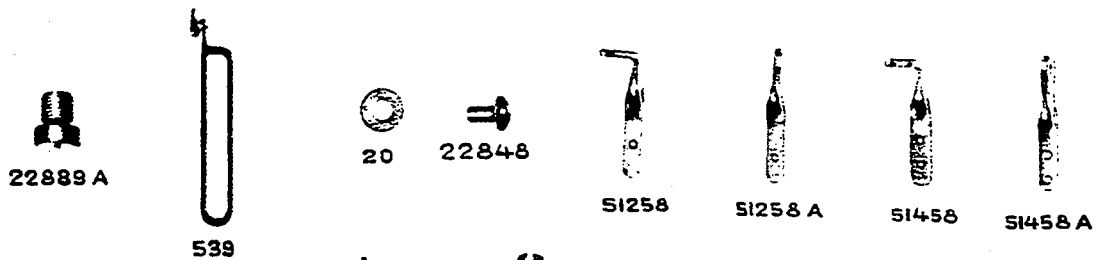
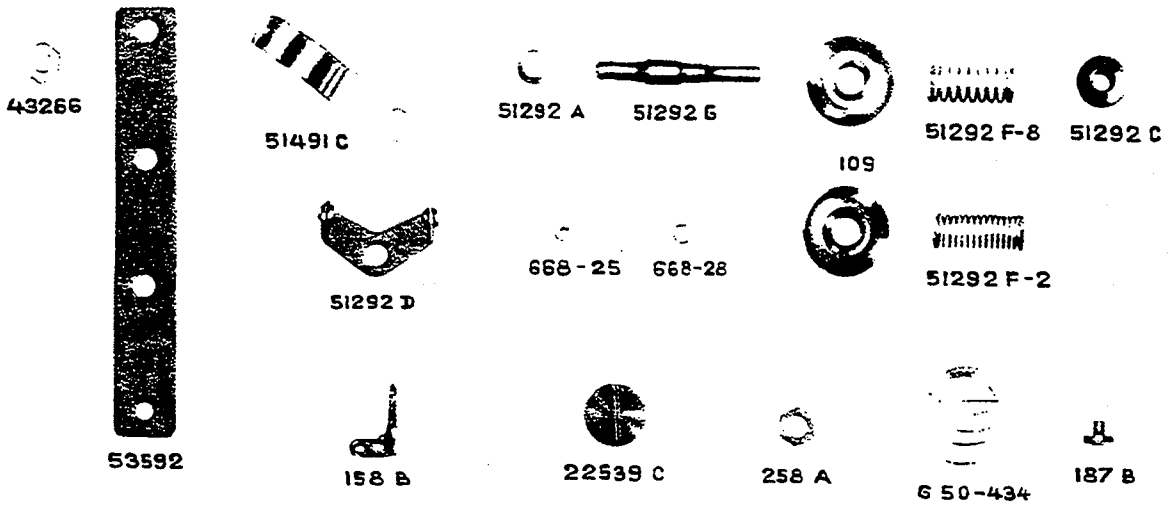

52894 AB

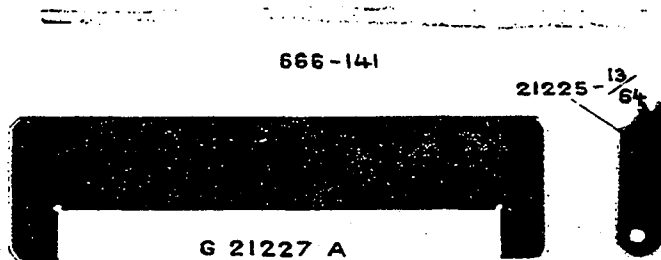
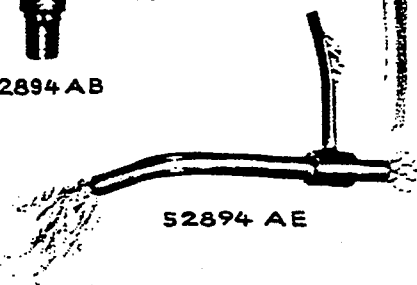

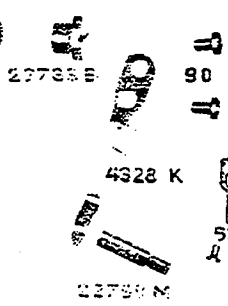
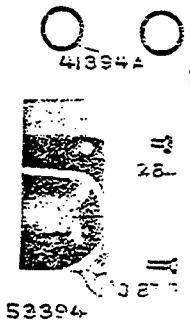
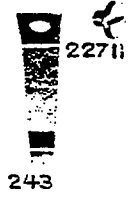
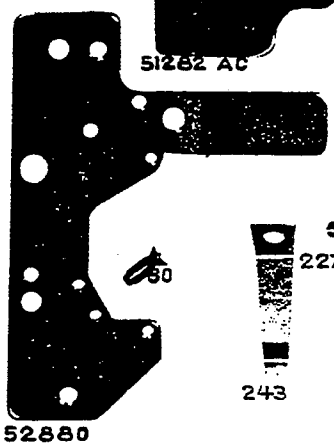
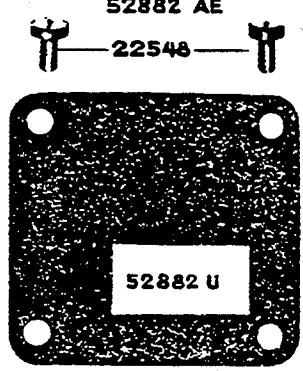
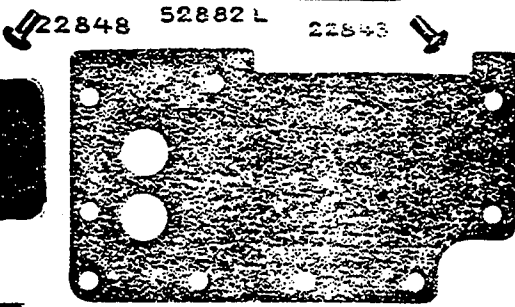
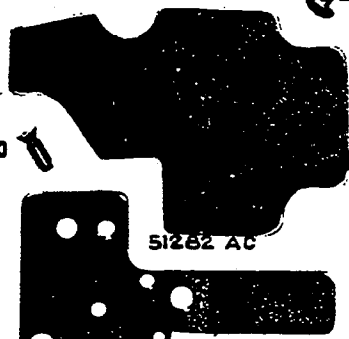
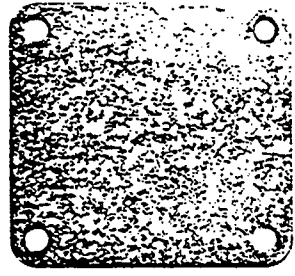
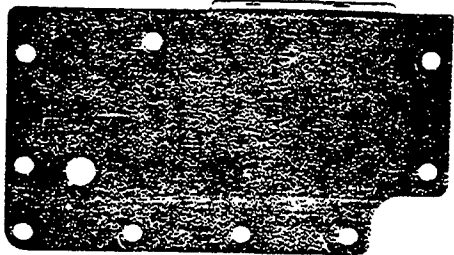
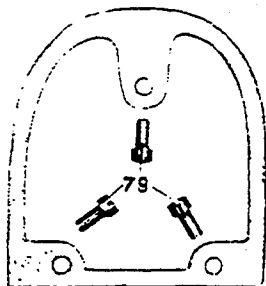
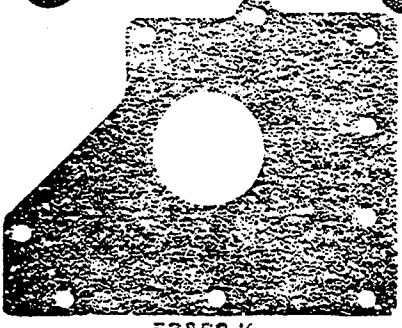
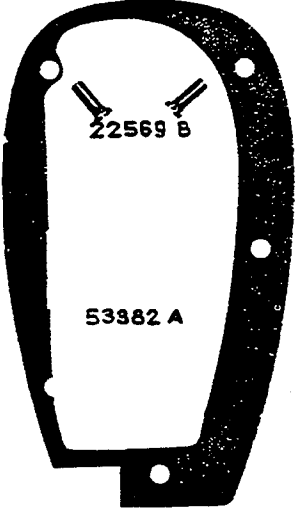
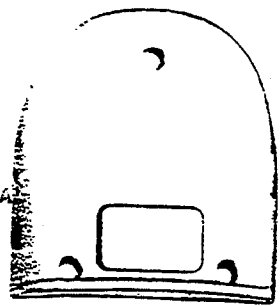
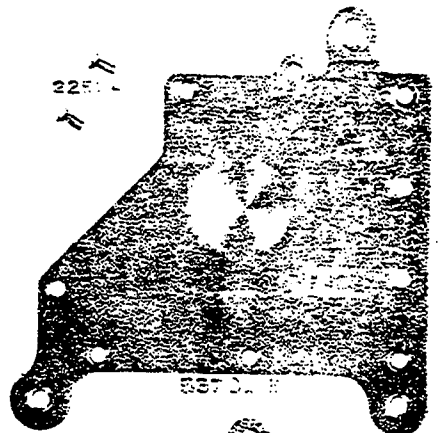
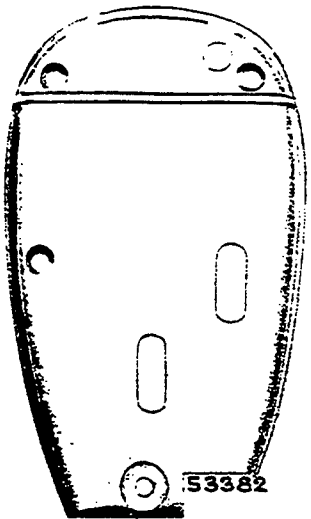

8

8



52802 C

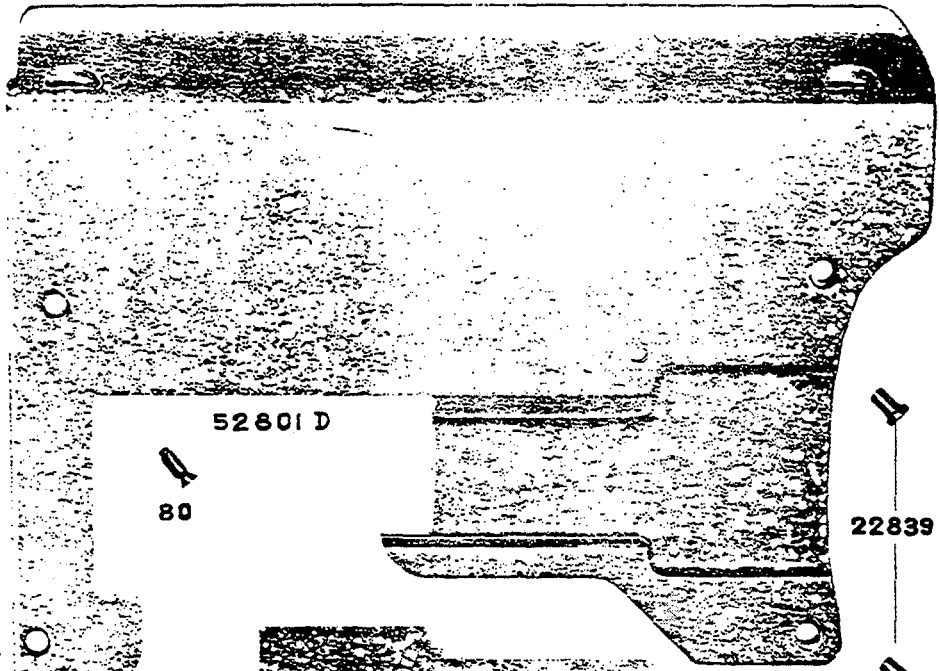

52801 D

80

22839 C

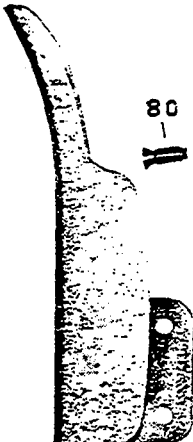

80

98 A

51291 A

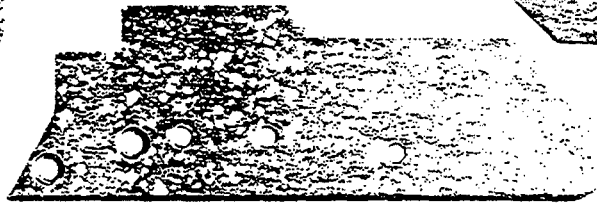

53364



93 A

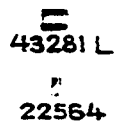

43281 L

22564

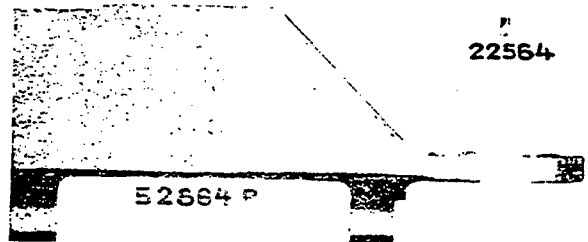

52864 P



52885 H



22848

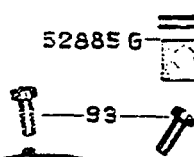

93

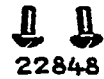

22848

52885 G



52885 J



22848



52885 G



B 52885 A

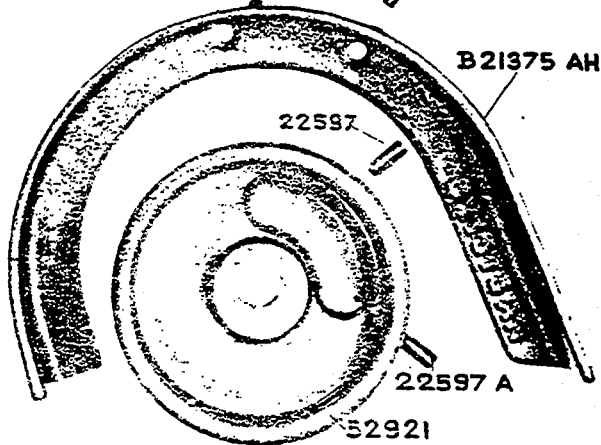

22597

B21375 AH

22597 A

52921

51150

53362
52883 R

51257 AA
52894 AE
52894 AD
52836 P
53394 A
258 A
660-136

51242 S
51290 T

52836 P
52890 C
52836 R

G39290 B
643-127

52891 A
53391
53361
52890 C
53344 C

51242 Z
51242 R
51244 M
53394 B

51493 K

51493 F *
51493 AG **

A
22539 H

B
666-111

C
51785
666-118

D
22571 D

E
666-65

F
22571 D

D
666-65
E
666-114

F
22571 D

35178 D
35178 D

22571 D

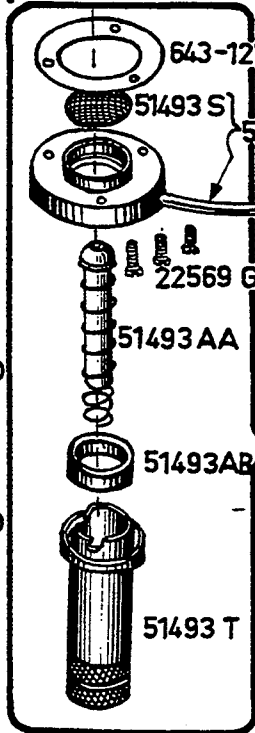

BEGINNING WITH SERIAL No. D 80641
THESE PARTS ARE REMOVED.

* TILL SERIAL No. 589053
** BEGINNING WITH SERIAL No. D 80641

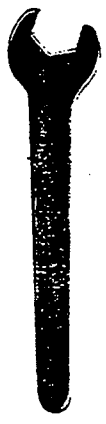

21388 B

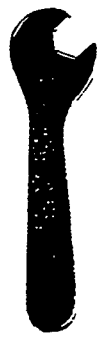

21388



21388 W

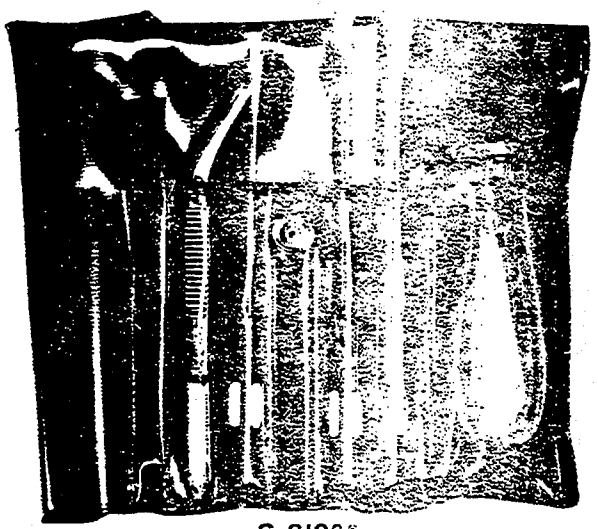

G 21208

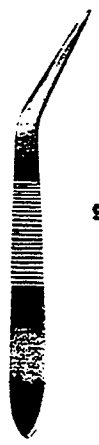

118 B

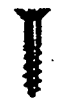

90562



116



90561

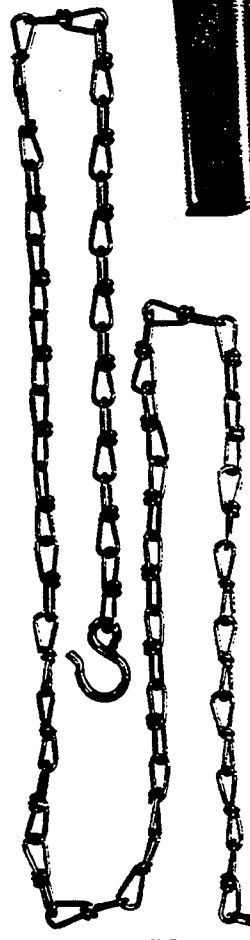

421

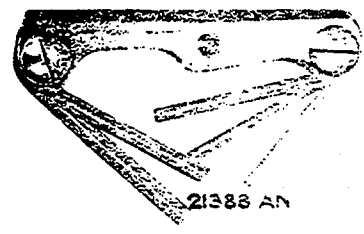

21388 AN



21202



21201

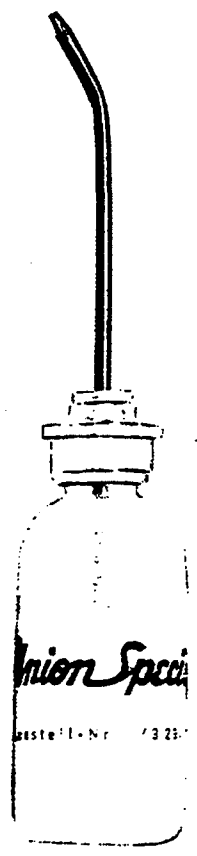

G 43294 B



51295 B



39595



22823 B



22823 A



22645 H-64



29402



53470

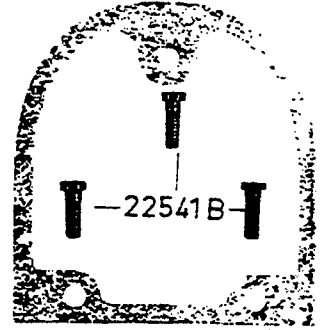
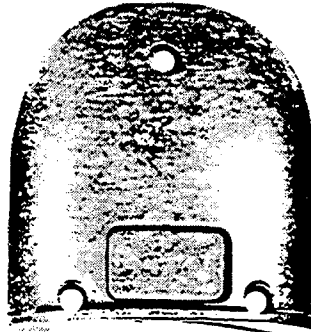

52882 AD

52882 P



A9109



20



25S



53371 C

G 22764 A

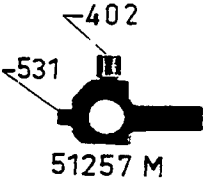

51257 M

402

531



12865



88



88

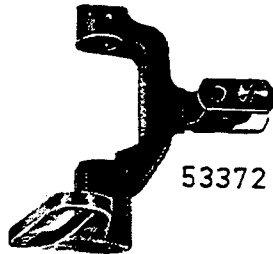

53372 A



53362 A



53376 B



53376 A

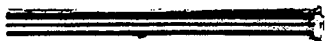

53377 B

51242 L

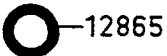

12865

1278



88



88



53371 B

G 22764 A

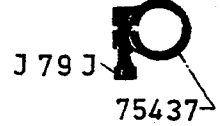

J 79 J

75437

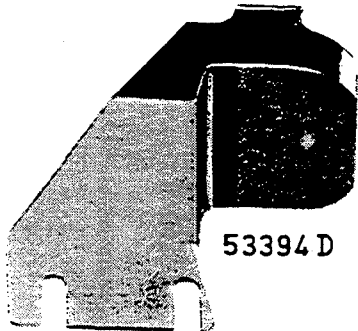

53394 D

531 51493 K

51493 D

51493 AG

51493 AH

G 51493 AG Compl.

53366 A



53361 B



22539 H



22730



22730

53344 F



22569 B

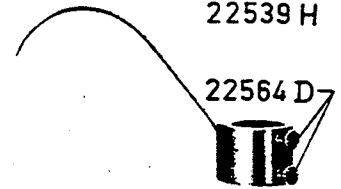

22564 D

53394 C

Nachtrag zum Katalog Nr. 228

1.3.59

Für Maschinen ab Serien-Nummer 88831 der Klasse 53300/53400.
Abbildung siehe Rückseite.

Teil Nr.	Beschreibung	Anz.
20	Unterlegscheibe für 25 S und 22848	2
25 S	Schraube, Gew. Q - 2 für A 9109	1
J 79 J	Schraube, Gew. L - 2 für 75437	1
88	Schraube, Gew. J - 2 für 12865 und 53367	3
402	Schraube, Gew. J - 2 für 51257 M	1
531	Schraube, Gew. J - 2 für 51257 M und 51493 K	3
1278	Unterlegscheibe zwischen Gestell und 53372 A	1
HA 1286 B	Spiralfeder in 53377 B	1
A 9109	Fadenabzug (nur bis Serien-Nummer 88830)	1
12865	Stellring (2-88) je 1 für 53371 B, 53377 B	2
12964 C	Stahlkugel in 53377 B	1
22539 H	Verschlußschraube, Gew. AF in 53361 B	1
22541 B	Schraube, Gew. L - 2, 3-für 52882 AD	3
22560	Schraube, Gew. J - 2, ersetzt Schraube 78 in 53352	1
22564 D	Schraube, Gew. G - 2, 2-für 53394 C	2
22569 B	Schraube, Gew. L - 2, 3-für G 51493 AG	3
G 22764 A	Spitzschraube, Gew. J - 2, je 1 für 53371 C, 53371 B	2
22848	Schraube, Gew. J - 2, 1-für 53470	1
22889 A	Schraube mit Innengew. J - 2, im Gestell	2
51242 L	Unterlegscheibe zwischen Buchse 53362 A und Stellring 75437	1
51257 M	Drückenfußstangenführung (1 - 531, 1 - 402)	1
51493 D	Öelpumpenachse (kpl. G 51493 AG)	1
51493 E	Öelpumpenzahnrad (kpl. G 51493 AG)	2
51493 K	Öelpumpenkegelrad (2 - 531, kpl. G 51493 AG)	1
51493 AG	Pumpengehäuse (kpl. G 51493 AG)	1
51493 AH	Abdeckscheibe (kpl. G 51493 AG)	1
G 51493 AG	Öelpumpe kpl. besteht aus 1 - 51493 D, 2 - 51493 E, 1 - 51493 K, 1 - 51493 AG, 1 - 51493 AH (3 - 22569 B)	1
52882 P	Dichtung für Deckel 52882 AD	1
52882 AD	Deckel über Kammkurve kpl. (3 - 22541 B)	1
53344 F	Fiberscheibe, ersetzt 15444 F	2
53361 B	Buchse im Gehäuse unten für 53366 A	1
53362 A	Buchse im Gehäuse oben für 53366 A	1
53366 A	Achse für Kammkurve	1
53371 B	Achse für 53372 A im Gestell vorn	1
53371 C	Achse für 53372 A im Gestell hinten	1
53372 A	Nadelstangenantriebsrahmen	1
53376 A	Buchse für 53377 B im Gestell vorn	1
53376 B	Buchse für 53377 B im Gestell hinten	1
53377 B	Nadelrahmenholzen kpl. besteht aus 1 - HA 1286 B, 1 - 12964 C, 1 - 53377 C, 1 - 80090 E	1
53377 C	Bolzen allein für 53377 B	1
53394 C	Öelfangblech kpl. (2 - 22564 D)	1
53394 D	Öelschutzblech (2 - 22730)	1
53470	Fadenabzug (1 - 20, 1 - 22848, 1 - 22889 A)	1
75437	Stellring (1 - J 79 J)	1
80090 E	Verschlußschraube in 53377 B	1

Supplement of Catalog 228 E

Only for machines with Serial numbers higher than 88830 of
Styles 53300/53400.

Part No.	Description	Am. Req.
20	Washer, for Nos. 25 S and 22848	2
25 S	Screw, for No. A 9109	1
J 79 J	Screw, for No. 75437	1
88	Screw, for Nos. 12865 and 53367	3
402	Screw, for No. 51257 M	1
531	Screw, for Nos. 51257 M and 51493 K	3
1278	Washer, for No. 53372 A	1
HA 1286 B	Spring, for No. 53377 B	1
A 9109	Needle Thread Take-up Wire (not for machines higher than Serial number 88830)	1
12865	Shaft Collar (2- 88), for Nos. 53371 B and 53377 B	2
12964 C	Ball, for 53377 B	1
22539 H	Plug Screw, for 53361 B	1
22541 B	Screw, for 52882 AD	1
22560	Screw, (Replaces Screw No. 78 in No. 53352)	3
22564 D	Screw, for No. 53394 C	1
22569 B	Screw, for G 51493 AG	2
G 22764 A	Spot Screw, for Nos. 53371 C and 53371 B	3
22848	Screw, for No. 53470	2
22889 A	Adapter Screw	1
51242 L	Washer	2
51257 M	Presser Bar Connection and Guide (1- 531, 1- 402)	1
51493 D	Oil Pump Driving Shaft (compl. G 51493 AG)	1
51493 E	Oil Pump Driving Shaft Gear (compl. G 51493 AG)	1
51493 K	Oil Pump Driven Gear (2- 531; compl. G 51493 AG)	2
51493 AG	Oil Pump Housing (compl. G 51493 AG)	1
51493 AH	Oil Pump Housing Cover (compl. G 51493 AG)	1
G 51493 AG	Oil Pump Assembly; one each Nos. 51493 D, 51493 K, 51493 AG, 51493 AH, two No. 51493 E	1
52882 P	Gasket	1
52882 AD	Crank Chamber Oil Reservoir (3- 22541 B)	1
53344 F	Fibre Washer, replaces 15444 F	1
53361 B	Lower Cam Shaft Bushing	2
53362 A	Upper Cam Shaft Bushing	1
53366 A	Cam Shaft	1
53371 B	Needle Bar Frame Rocker Shaft, in front	1
53371 C	Needle Bar Frame Rocker Shaft, rear	1
53372 A	Needle Bar Frame Rocker	1
53376 A	Needle Bar Frame Shaft Bushing, in front	1
53376 B	Needle Bar Frame Shaft Bushing, rear	1
53377 B	Needle Bar Frame Shaft Assembly; one each Nos. HA 1286 B, 12964 C, 53377 C, 80090 E	1
53377 C	Needle Bar Frame Shaft, for Assembly 53377 B	1
53394 C	Oil Guard (2- 22564 D)	1
53394 D	Oil Guard (2- 22730)	1
53470	Needle Thread Take-up Wire (1- 20, 1- 22848, 1- 22889 A)	1
75437	Shaft Collar (1- J 79 J)	1
80090 E	Plug Screw in 53377 B	1

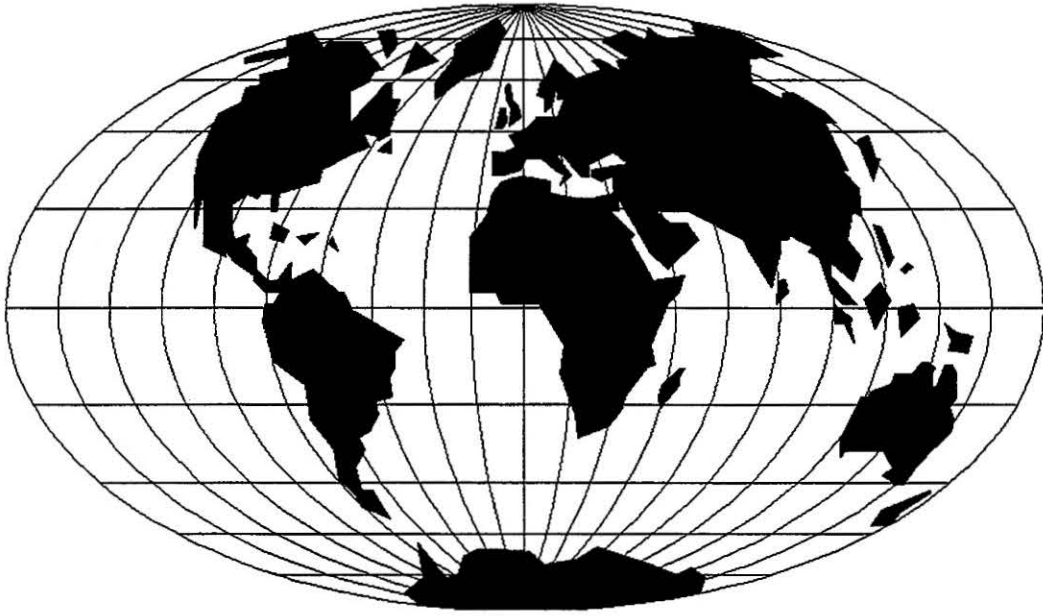

WORLDWIDE SALES AND SERVICE

Union Special Corporation maintains sales and service facilities throughout the world. These offices will aid you in the selection of the right sewing equipment for your particular operation. Union Special Corporation representatives and service technicians are factory trained and are able to serve your needs promptly and efficiently. Whatever your location, there is a qualified representative to serve you.

Corporate Office: One Union Special Plaza
Huntley, IL 60142
Phone: 847•669•5101
Fax: 847•669•4454

European Distribution Center: Union Special GmbH
Raiffeisenstrasse 3
D-71696 Möglingen, Germany
Tel: 49•07141•247•0
Fax: 49•07141•247•100

Brussels, Belgium
Charlotte, N.C.
Hong Kong, China
Huntley, IL
Leicester, England
Lille, France
Miami, FL
Milan, Italy
Möglingen, Germany
Montreal, Quebec
Osaka, Japan
Santa Fe Springs, CA
Suwanee, GA
Wayne, NJ

Other Representatives throughout all parts of the world.



Union Special
INDUSTRIAL SEWING EQUIPMENT