



Union Special[®]
INDUSTRIAL SEWING EQUIPMENT

STYLES

**ADJUSTING INSTRUCTIONS AND
ILLUSTRATED PARTS LIST**

52800M

52800N

52800P

52800R

52800S

52800T

52800U

52800V

52800W

52800X

**CLASS 52800 STREAMLINED FLAT BED FOUR
AND FIVE THREAD INTERLOCK MACHINES**

**CATALOG
NO. 98L**

**FIRST
EDITION**

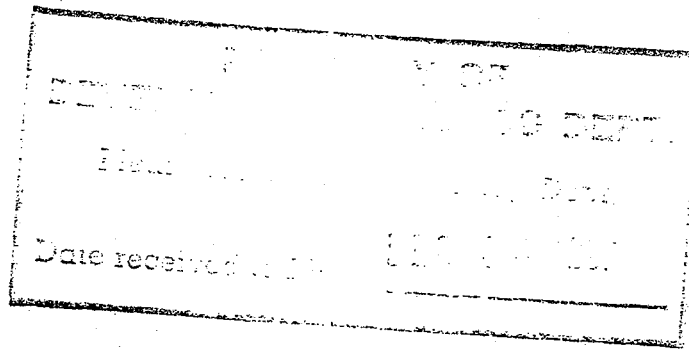

Catalog No. 98 L

LIST OF PARTS

The Streamlined Class 52800

Styles

52800 M	52800 T
52800 N	52800 U
52800 P	52800 V
52800 R	52800 W
52800 S	52800 X

The parts listed in this catalog are furnished
at list prices for repairs only.

First Edition

Copyright 1948

By

Union Special Machine Co.
Rights Reserved In All Countries

Union Special Machine Co.
Chicago, 10, U. S. A.

Printed in U. S. A.



Union Special®

INDUSTRIAL SEWING MACHINES

• Africa

BULAWAYO, SO. RHODESIA, FEDERATION OF RHODESIA and NYASALAND, Berzack Bros. Ltd., 16 14th Avenue. (Textile Machines).
CASABLANCA, MOROCCO, Etablissements Geissmann & Fils, 34 Blvd. de la Gare.
JOHANNESBURG, UNION OF SOUTH AFRICA, South African Scale Co., (Pty.) Ltd., P.O. Box 1463, 32 Von Brandis St., for bag closing machines. Branches also at Bloemfontein, (53 Zaston St.), Capetown, (Box 779), Durban, (22 Aliwal St.), East London (53A Cambridge St.) Pietermaritzburg, Port Elizabeth, (Box 611), Pretoria, Vereeniging and Worcester.
JOHANNESBURG, UNION OF SOUTH AFRICA, Berzack Bros. Ltd., Berbro House, 135/7 Pritchard St. Branches also at 487 West St., Durban; 78 Darling St., Capetown; 58 Queen St., Port Elizabeth. Textile machines.
MAURITIUS, Hall, Geneve, Langlois, Ltd., Port Louis, P.O. Box 77.
SALISBURY, SO. RHODESIA, FEDERATION OF RHODESIA and NYASALAND, So. African Scale Co., Corner of Forbes and Angwa Sts., Bag Closing Machines.

• Asia

CALCUTTA, INDIA, Don Watson & Co., Ltd., 19 British Indian St.
DACCA, PAKISTAN, Roberts & McLean & Co., Ltd., 91 Nawabpur Rd., Bag closing and Bag seaming machines.
DELHI 6, INDIA, Munshi Ram Bs. C., P.O. Box 1114, Kashmere Gate. Above Keventers.
HONGKONG, G. R. Coleman Co. (Hongkong) Ltd., Room 308, Bank of Canton Bldg., 6 Des Voeux Road, Central.
KARACHI 2, PAKISTAN, Universal Trading Corp., Textile Machines, 29 Zeenat Mansion, McLeod Road, P.O. Box 4635.
OSAKA, JAPAN, Mima Sewing Machine Mfg. Co. 29, 1-chrome, Ebi-kami, Fukushima—KU.
SEOUL, KOREA, Uebersee-Handel A. G., Iwang Wha Moon, P.O. Box 268.
TAIPEI, TAIWAN, G. R. Coleman, Hongkong, Ltd., 78 Po Ai Road.
TOKYO, JAPAN, Iwase Sewing Machine Co., Ltd., 39, 1-chrome, Kamezawa-cho, Sumida—KU.

• Australia

BRISBANE, AUSTRALIA, Capron, Carter (Pty.) Ltd., Rm. 55—Rex Bldg., Wickham St., Valley.
MELBOURNE, VICT., AUSTRALIA, Capron, Carter (Pty.) Ltd., 78 A'Beckett St.
SYDNEY, N.S.W., AUSTRALIA, Capron, Carter (Pty.) Ltd., 86 Liverpool St.

• British West Indies

KINGSTON, JAMAICA, B. W. I., Mr. Morris E. Parkin, 102 King St.

• Canada

Union Special Machine Co. of Canada, Ltd.
CALGARY, ALTA., 1809 24th Ave., N.W. N. W. Halt, Tel. 891690.
MONTREAL 14, QUE., 40 Moliere St., Clyde F. Amey, Tel. Victoria 2575.
QUEBEC, P. Q., Ave. Des Pins Ouest. Lucien Bouchard. Tel. 3-8126.
★TORONTO 2, ONT., 135 Peter St. S. J. Storey, Mgr. Tel. Empire 6-2939.
WINNIPEG, MAN., Room 201, Whitla Bldg., Frank Thierman. Tel. 934933.

• Europe

AMSTERDAM, THE NETHERLANDS, N. V. Machinehandel C. & H. Verbeek, Kloveniersburgwal 77. Also offices in: Rotterdam, Sittard, Groningen, Enschede, Eindhoven.
ATHENS, GREECE, Michel D. Dimoulis, Rue Deka, 4A.
BARCELONA, SPAIN, Rapida, S. A. Avino 9.
BERGEN, NORWAY, Jac. Jacobsen A/S, Bjornsongst 24.
BORAS, SWEDEN, Rud. Nystrom & Co., A/B, Lilla Bannerigatan 6.
BRUSSELS, BELGIUM, Union Special Machine Corporation of America, 23 Rue Philippe de Champagne. Henri Deloof, Mgr.

COPENHAGEN, DENMARK, Rothenborg Specialmaskiner for Sy-Industrian A/S, Nikolaj Plads 23. Also offices in: Herning, Kolding, Odense, Silkeborg, Riisakov.
DUBLIN, EIRE, Machines, Ltd., 24 Upper Abbey St. Textile Machines.
DUNDEE, SCOTLAND, Thomas C. Keay, Ltd., 15 Baltic St. Bag Closing and Bag Making.
HELSINKI, FINLAND, Suomen Koneliike O/Y, Vihonkatu 9.
LEICESTER, ENGLAND, Union Special Machine Co., Ltd., 25 Bade St. Braunstone Gate, A. B. Fitzpatrick, Mgr. Textile Machines.
LONDON, E. C. 1, ENGLAND, Union Special Machine Co., Ltd., Parksworth House, 30, City Road. Textile Machines.
MALMO, SWEDEN, Rud. Nystrom & Co., A/B Vargatan 10-A.
MILANO, ITALY, Giovanni Conti y Nipoti, Piazzale Marengo 6.
NOTTINGHAM, ENGLAND, Mr. W. Wilkes, Plantation Road, Wellaton. Textile Machines.
OPORTO, PORTUGAL, Rost & Janus, Sucrs., Rua Barao de Forrester, 914.
OREBRO, SWEDEN, Rud. Nystrom & Co., A/B Skebacksvagen 17-19.
OSLO, NORWAY, Jac. Jacobsen A/S, Kr. Augustsgate 19 (Tullingarden).
PARIS, FRANCE, Cie. des Machines Union Special de France, 91 Avenue de la Republique, Georges Linotte, Mgr.
STOCKHOLM, SWEDEN, Rud. Nystrom & Co., A/B, St. Nygaten 10-12.
STUTTGART, GERMANY, Union Special Maschinenfabrik, G.m.b.h., Schwabstrasse 33, A. W. Krieger, Managing Director.
VIENNA, VI, AUSTRIA, Firma Nahschuster, Mariahilferstr., 51.
ZURICH, 9/47, SWITZERLAND, M. L. Bourquin, Albisriederstrasse 226.

• Latin America

Union Special International, Inc.
BARRANQUILLA, COLOMBIA, C. Ceballos & Cia., Ltda., Almacenes "Carceco," Banco Comercial, Anticueno, OF. 401.
BOGOTA, COLOMBIA, C. Ceballos & Cia., Ltda., Avenida Caracas 17-18.
BUENOS AIRES, ARGENTINA, Kay, Grandjean & Cia., Bartolome Mitre 760.
CALLI, COLOMBIA, C. Ceballos & Cia., Ltda., Calle 4, No. 9-21.
CARACAS, VENEZUELA, H. Blohm, S.A., Dr. Paul A. Charro 29.
CIUDAD TRUJILLO, DOMINICAN REPUBLIC, Luis Dominguez, Apartado 57, Hostos esq. El Conde.
GUADALAJARA, JAL., MEXICO, Talleres Perez Zozaya, S. A. Hidalgo 45 y 47.
GUATEMALA CITY, GUATEMALA, Cia. Agro Comercial S.A., 8a Ave. Sur. 10-43. Bag Closing Machines.
HAVANA, CUBA, Antilla Yarn & Supply Co., S. A. Factoria 70, Textile, Bag Seaming, and Shoe Machines.
HAVANA, CUBA, Mr. Miguel A. Vilato, Apartado No. 124, Bag Closing Machines.
LIMA, PERU, A. y F. Wiese, S.A., Esq. Nunez y Filipinas.
MANAGUA, NICARAGUA, Hentgen & Co., Ltd., Apartado 14. 5 A. Calle, N. O. 214.
MEDELLIN, COLOMBIA, C. Ceballos & Cia., Ltda., Carrera Junin 44-34.
MEXICO, D.F., MEXICO, Perez Zaragoza, S.A., Regina 26.
MONTERREY, N.L., MEXICO, Talleres Perez Zozaya, S.A., Apartado 197, Cuahatemoc Norte 335.
MONTEVIDEO, URUGUAY, Carlos Dighiero e Hnos, Convencion 1424.
PORTO ALEGRE, RIO GRANDE DO SUL, BRAZIL, Casa de Maquinas Falk, Ltda., Rua Hoffman 533. Bag Closing and Bag Making Machines.
PORTO ALEGRE, RIO GRANDE DO SUL, Maquinas de Costura Panambra, S.A., Rua Siqueira de Campos 1172. Textile Machines.
RECIFE, PERNAMBUCO, Maquinas de Costura Panambra, S.A., Av. Guararapez 154. Textile Machines.

REPRESENTATIVES

RIO DE JANEIRO, D.F., Maquinas de Costura Panambra, S.A., Rua Alexandre Mackenzie 117. Textile Machines.
 SAN JOSE, COSTA RICA; Champion Co., Ltda., APDO. 2742.
 SAN JUAN, PUERTO RICO, Abarca Warehouse, Inc., P.O. Box 2352.
 SAN LUIS POTOSI, S.L.P., MEXICO, Talleres Perez Zozaya, J. de los Reyes 80.
 SAN SALVADOR, EL SALVADOR, Vairo Hermanos, Colonia Vairo.
 SANTIAGO, CHILE, Lowenstein & Stewart, S.A.C., P.O. Box 2195, Calle Santo Domingo 1140.
 SAO PAULO, BRAZIL, Casa de Maquinas Falk, Ltda., Av. Duque de Caxias 610. Bag Closing & Bag Making Machines.
 SAO PAULO, BRAZIL, Maquinas de Costura Panambra, S.A., Rua Brigadiero Tobias 388. Textile Machines

• Near East

BAGHDAD, IRAQ, Sons of O. O. Agopian, P.O. Box 121.
 BEIRUT, LEBANON, Sons of O. O. Agopian, P.O. Box 1165.
 CAIRO, EGYPT, Mr. A. Kavalidjian, 4, Midan El-Hami, Kasr el Nil Bridge.
 DAMAS, SYRIA, Elias Aractingi & Fils, Sidi Amoud.
 ISTANBUL, TURKEY, David ve Varber ve Seriki, Hamdi Bey Gecidi 36, 38, 40, Posta Kutusu 385.
 TEL AVIV, ISRAEL, L. Taube, Ltd., 15 Lilienblum St.

• New Zealand

Sole Distributors—H. A. Tuck & Co., Ltd.
 AUCKLAND, 171 Albert St., C. I. (Head Office)
 WELLINGTON, Ford Bldg., Courtenoy Place.
 CHRISTCHURCH, (Sub-Agents) Glendermid, Ltd., 78 Lichfield St.
 DUNEDIN, (Sub-Agents) Glendermid, Ltd., 18 Dowling St.

• Pacific Islands

CEBU, THE PHILIPPINES, Atkins, Kroll and Co., Inc., Textile Machines.
 HONOLULU, HAWAII, Commercial Sewing Machine Service, Ltd., 732 Ilaniwai St. Textile Machines.
 HONOLULU, HAWAII, H. S. Gray Company, P.O. Box 3016, 759 Puuloa Rd. Bag Closing Machines.
 MANILA, PHILIPPINE ISLANDS, Atkins, Kroll & Co., Inc., 124 Myers Bldg., Port Area. Textile Machines.
 MANILA, PHILIPPINE ISLANDS, Earnshaws Docks & Honolulu Iron Works Co., Corner of Tacoma and 2nd Sts., Port Area. Bag Closing Machines.

• United States

ALLENTOWN, PA., 1512 Catalina Ave., Box 542, L. D. Cassell. Tel. Hemlock 4-3900.
 ★ATLANTA, GA., 81 Peachtree Pl., N.W., M. O. Moulton, Mgr. Tel. Atwood 2733, 2734.
 BALTIMORE 15, MD., P.O. Box 2505 R. B. Foster. Tel. Sar. 7-8499.
 BELLEVILLE, N. J., 18 Preston St., D. C. Jenkins. Tel. Plymouth 1-0304.
 ★BOSTON 11, MASS., 179 Lincoln St., Wm. E. Palm, Mgr. Tel. Liberty 2-0147-48.
 ★CHICAGO 10, ILL., 404 N. Franklin St., O. A. Ullrick, Mgr., Tel. Superior 7-6920.
 ★CINCINNATI 25, O., 3372 Central Pkwy. A. E. Brauch, Mgr. Tel. Kirby 5558.

CLEVELAND 11, OHIO, 11902 Milligan Ave., David G. Lee. Tel. Clearwater 1-3462.
 COLUMBIA, S. C., 319 Howard St., C. A. Page, Tel. 6-8806.
 COMMERCE, GA., State St. J. T. Hanley. Tel. 3-6872.
 CONYNGHAM, PA., Box 46, Robert S. Vogt. Tel. Sunset 8-5556.
 DALLAS 2, TEXAS, P.O. Box 5013. Emmett Richards. Randolph 5722.
 DENVER 10, COLO., 1801 South Marion St. L. E. Carter, Tel. Spruce 7-7060.
 DETROIT 21, MICH., 16630 Ward Ave. John F. Lux, Tel. University 3-4948.
 GREENSBORO, N. C., P.O. Box 226. W. D. Harrod. Phone: 3-7648.
 GREENVILLE, S. C., 119 Phillips Lane, M. M. Ambrose, Tel. 3-4647.
 INDIANAPOLIS 1, IND., 3731 N. Tacoma Ave. B. L. Rogers. Tel. Liberty 6-2277.
 JACKSON, MISS., 327 Eastview St. J. A. Boyette. Tel. 5-1976.
 JOHNSON CITY, N. Y., 471 Main St., J. J. Lafer, Tel. 7-3994.
 KANSAS CITY 41, MO., P.O. Box 824, T. O. Biggers, Tel. South 5030.
 LATHAM (TROY), NEW YORK, 19 Aragon Ave., J. R. LeTournneur, Tel. State 5-6663.
 LYNCHBURG, VA., P.O. Box 1075. C. D. Mairs. Tel. 3-1215.
 ★LOS ANGELES 15, CAL., 119 E. Pico Blvd. P. M. Mason, Mgr. Tel. Richmond 7-9187, 7-9188.
 MEMPHIS, TENN., 4695 Dunn Rd., R. J. Lindhorst, Tel. Mutual 5-6750.
 MIAMI 37, FLA., 2101 Northwest 1st Ave., H. L. Simon, Tel. 82-0323.
 MINNEAPOLIS, MINN., 2800 Texas Ave., St. Louis Park, Minn. Leonard Koehler. Tel. Midway 6236.
 NASHVILLE 12, TENN., 1602 South Observatory Drive. W. J. Brauch. Tel. Cypress 2-5123.
 NEW ORLEANS, LA., 59 W. Claiborne Square, Chalmette, La., L. A. Van Hooser. Tel. Edgewood 1-3106.
 ★NEW YORK 16, N.Y., 116 E. 27th St. W. G. Booth, Mgr. Tel. Murray Hill 9-1266, 9-1267, 9-1268.
 ★PHILADELPHIA 7, PA., 1316 Arch St. B. W. Merz, Mgr. Tel. Locust 7-1023.
 PITTSBURGH 26, PA., 521 Brookline Blvd., Richard Marsh, Tel. Locust 3-3589.
 PLANT CITY, FLA., 214 N. Gordon St. J. C. Morgan. Tel. 3-2681.
 PORTLAND 7, ORE., P.O. Box 843, Marvin H. Corns. Capital 3-7500.
 RAYNHAM, MASS., P.O. Box 141. W. P. Godek. Tel. Tauton 2-5149.
 RUTHERFORD, N. J., 246 Sylvan St., Richard Whitson. Tel. Geneva 8-2178.
 ★ST. LOUIS, MO., 1517-21 Olive St., Z. X. Bennett, Mgr. Tel. Chestnut 1-2368.
 SALT LAKE CITY, UTAH, 1215 E. 13th South St. L. F. Rosvall.
 SAN ANTONIO, TEXAS, P.O. Box 201, H. E. Pearson. Tel. Pershing 2-2884.
 SAN FRANCISCO 7, CALIF., 1275 Mission St. R. J. Vail. Tel. Underhill 1-1580.
 SEATTLE, WASH., 808 Motor Pl. Paul Lockett. Tel. Seneca 8083.
 TUPELO, MISS., 831 Strauss St., Lloyd Baldwin. Tel. 1859-J.
 WAKEFIELD, MASS., 195 North Ave., H. Haberman Jr., Tel. Crystal 9-0455.
 YORK, PA., 444 South George St. Richard L. Smith. Tel. York 8-5592.

FOREWORD

The new Streamlined Class 52800 brings to the knit goods industry new styling, improved lubrication, and light running high speed performance. Enclosed type oiling system for looper drive eccentric, spreader drive eccentric, and needle lever crank have substantially increased the speed of these machines. The almost entirely automatic lubrication system - there are only three places to oil - has made maintenance simple. All parts are made to precision gauges insuring complete interchangeability.

It is our constant aim to furnish carefully prepared information that will enable the customer to secure all possible economies from the use of Union Specials. The following pages illustrate and describe the parts for the styles in Class 52800.

Additional catalogs, containing information relative to these machines, and which will be furnished on request, are listed below:

Catalog No. 29	
Third Edition	List of miscellaneous accessories and transmitter parts
Catalog No. 45	Needle Manual
Form 357	Engineering Department
Adjusting Instructions.	Specify the style of machine for which the adjusting instructions are required.

In all manufacturing centers will be found Union Special representatives, who will cooperate with those who desire in planning and estimating their requirements.

UNION SPECIAL MACHINE COMPANY

Engineering Department

IDENTIFICATION OF MACHINES

Each Union Special carries a style number which is stamped in the name plate on the machine. Style numbers are classified as standard and special. Those which are standard have one or more letters suffixed, but never contain the letter "Z". Example: "52800 M". Style numbers containing the letter "Z" are special. When only minor changes are made in a standard machine a "Z" is merely suffixed to the respective standard style number. Example: "52800 MZ".

Styles of machines similar in construction are grouped under a class number which differs from the style number in that it contains no letters. Example: "52800".

APPLICATION OF CATALOG

This catalog applies only to the standard styles of machines as listed herein. It can also be applied with discretion to the special machines in Class 52800.

STYLES OF MACHINES IN CLASS 52800

Streamlined Enclosed Type Flat Bed Four and Five Thread Interlock Machines, Stitch Types 602 and 605, Lateral Looper Travel, Work Space To Right Of Needle Bar 7 3/4 Inches, Enclosed Type Oiling System For Looper Drive Eccentric And Crank, Floor Treadle Lifter.

52800 M For attaching cuffs to knitted undergarments; one operation lap seam Type FSA-1, Five Thread Interlock Stitch Type 605, three needles, wrench adjustment off-set differential feed, standard gauge No. 16.

52800 N For seaming medium and heavy weight undergarments; one operation lap seam Type FSA-1, Five Thread Interlock Stitch Type 605, three needles, three-section bottom presser foot, wrench adjustment tandem differential feed, standard gauge No. 16.

52800 P For attaching split tube border to neck and armholes of athletic shirts made from light weight knitted cotton and rayon fabrics; seam Type BSA-1, Four Thread Interlock Stitch Type 602, two needles, long length light weight flat knit strip, cut parallel with wale, wrench adjustment off-set differential feed, treadle operated intermittent strip tension for releasing tension on armholes and straight sections of neck, gauge for measuring length of straps for built-up shoulders, folder has 3/64 inch capacity and uncurlers at both loading and delivery end, standard gauge No. 8, standard finished widths 7/16, 1/2, 5/8, and 3/4 inch.

52800 R Same as 52800 P except it is equipped with treadle controlled intermittent differential feed and is not equipped with the intermittent strip tension.

IDENTIFICATION OF MACHINES

STYLES OF MACHINES IN CLASS 52800 (Cont'd.)

- 52800 S For attaching split tube border to men's and women's underwear, and similar garments made from light weight knitted cotton and rayon fabrics; seam Type BSA-1, Four Thread Interlock Stitch Type 602, two needles, long length light weight flat knit strip cut parallel with wale, wrench adjustment off-set differential feed, constant strip tension, folder has $\frac{3}{64}$ inch capacity and uncurler at loading end only, standard gauge No. 8, standard finished widths $\frac{1}{2}$, $\frac{5}{8}$, $\frac{3}{4}$, $\frac{7}{8}$, and 1 inch.
- 52800 T For attaching knitted tubing, elastic, and previously made lace to knitted undergarments; lap seam Type FSA-1, Four Thread Interlock Stitch Type 602, two needles, wrench adjustment tandem differential feed, standard gauges, Nos. 8, 10, 12.
- 52800 U For attaching collarettes to knitted undergarments; seam Type BSA-1, Four Thread Interlock Stitch Type 602, two needles, long length rib knit strip cut perpendicular to the wale or parallel with the wale, wrench adjustment off-set differential feed, constant strip tension, folder has $\frac{1}{16}$ inch capacity, standard gauges Nos. 8, 12, standard finished widths $\frac{3}{4}$, $\frac{7}{8}$, 1 and $1\frac{1}{4}$ inches.
- 52800 V For attaching collarettes to knitted undergarments; seam Type BSB-1, Four Thread Interlock Stitch Type 602, two needles, long length flat knit or rib knit strip cut perpendicular to the wale or parallel with the wale, wrench adjustment off-set differential feed, constant strip tension, standard gauges Nos. 8, 12, standard finished widths for flat knit $\frac{1}{2}$, $\frac{5}{8}$, $\frac{3}{4}$, $\frac{7}{8}$, and 1 inch, standard finished widths for rib knit $\frac{3}{4}$, $\frac{7}{8}$, 1, and $1\frac{1}{4}$ inches.
- 52800 W For attaching collarettes to knitted undergarments; seam Type BSA-1, Five Thread Interlock Stitch Type 605, three needles, long length rib knit strip cut perpendicular to the wale or parallel with the wale, wrench adjustment off-set differential feed, constant strip tension, folder has $\frac{1}{16}$ inch capacity, standard gauges Nos. 14 and 16, standard finished widths $\frac{3}{4}$, $\frac{7}{8}$, 1 and $1\frac{1}{4}$ inches.
- 52800 X For patch operations on flat and rib knit undergarments; seam Type SSA-1, Five Thread Interlock Stitch Type 605, three needles, plain bottom presser foot, wrench adjustment tandem differential feed; standard gauge No. 16.
- 52800 Z A special style, similar to the standard styles in Class 52800, but differing in some of its component parts.

NEEDLES

TYPE NUMBERS AND SIZES

Each needle has a type number and size number. The former denotes the kind of shank, point, length, groove, finish, and other details. The latter denotes the largest diameter of the blade, measured in thousandths of an inch midway between the shank and eye, and is stamped in the needle shank. Collectively, the type number and size number is the complete symbol.

To have orders promptly and accurately filled, the empty package, a sample needle or the type and size number should be given. See marks on packages. An intelligent order would read as follows "1000 Needles Type 121 H Size 036". The type numbers of the needles available for use in the styles of machines covered by this catalog are listed below. Set opposite each type number is the description of the needle.

Type No.	Description
121	Round shank, round point, short, double groove, nickel plated - sizes 019, 022, 025, 027, 029, 032, 036, 038, 040, 042, 044, 049, 054, 060
121 G	Same as Type 121, except chromium plated - sizes 025, 027, 029, 032, 036, 040, 044, 049
121 H	Same as Type 121, except ball point - sizes 029, 032, 036
121 J	Round shank, round point, short double groove, sharp point, taper blade, diameter at eye is the size number and equals the diameter at top of blade minus .010 inch, plain finish - sizes 022, 025, 027, 032
121 JH	Same as Type 121 J, except ball point - size 027

APPLICATION OF TYPE NUMBERS TO MACHINES

The standard type of needle applicable to each style is listed in the description of each style. The styles of machines covered by this catalog are listed herewith. Set opposite the style numbers are the type numbers of the needles that can be used. Type numbers are arranged numerically, as the variety of the materials sewed on each machine makes it impractical to show a preference.

Machine Style	Type of Needles
52800 M	121, 121 G, 121 H, 121 J, 121 JH
52800 N	121, 121 G, 121 H, 121 J, 121 JH
52800 P	121, 121 G, 121 H, 121 J, 121 JH
52800 R	121, 121 G, 121 H, 121 J, 121 JH
52800 S	121, 121 G, 121 H, 121 J, 121 JH
52800 T	121, 121 G, 121 H, 121 J, 121 JH
52800 U	121, 121 G, 121 H, 121 J, 121 JH
52800 V	121, 121 G, 121 H, 121 J, 121 JH

NEEDLES (Continued)

APPLICATION OF TYPE NUMBERS TO MACHINES (Cont'd.)

Machine Style	Type of Needles
52800 W	121, 121 G, 121 H, 121 J, 121 JH
52800 X	121, 121 G, 121 H, 121 J, 121 JH

ORDERING REPAIR PARTS

PLATES

Illustrations of parts are arranged according to scale and, wherever possible, parts similar in appearance or function are grouped together.

When a given design of part is made in two or more sizes, only one illustration is usually shown. In ordering these pieces, it is necessary that the additional information be furnished as requested under these illustrations.

LIST OF PARTS

Turning from the plates to the list of parts, the description of each part and its principal uses will be found. Always check the symbol against its description before ordering. It is not necessary to furnish the plate number.

When a part is used, or can be used, in all machines covered by this catalog, no specific use is mentioned in the description.

For convenience in ordering, minor parts such as screws, nuts and similar articles are repeated after each major part.

(-) A dash in the "plate number" column of the list of parts indicate the absence of an illustration.

(‡) A double dagger in the "symbol to order by" column indicates that the component parts cannot be furnished separately. Due to the high speed of these machines and other factors it is impossible for these associated parts to be fitted a secone time and make a serviceable job.

IDENTIFYING PARTS

Where the construction permits, each part is stamped with its part number. Some of the smaller parts are stamped with an identification letter to distinguish them from parts similar in appearance.

All part numbers represent the same part, regardless of the catalog in which they appear.

SUPPLIES

All supplies, including taps, reamers, belting, belt hooks, belt fasteners, screw drivers, wrenches and powdered oil stone will be promptly furnished.

USE GENUINE NEEDLES AND REPAIR PARTS

Success in the operation of these machines can be secured only by the use of genuine Union Special Needles and Repair Parts as furnished by the Union Special Machine Company, its subsidiaries and authorized distributors. They are designed according to the most approved scientific principles, and are made with the utmost precision. The maximum efficiency and durability are assured.

ORDERING REPAIR PARTS (Cont'd.)

USE GENUINE NEEDLES AND REPAIR PARTS (Cont'd.)

Genuine needles are put up in packages marked at the top "trade 'UNION SPECIAL' mark". Genuine repair parts are stamped with a reproduction of the familiar Union Special padlocks.

Each trade mark is your guarantee of the highest quality in materials and workmanship.

TERMS

Prices are strictly "net cash" and subject to change without notice. All shipments are forwarded at the buyer's risk F.O.B. shipping point. Parcel post shipments are insured unless otherwise directed. A charge is made to cover the postage and insurance.

Plate 1 - Full Size

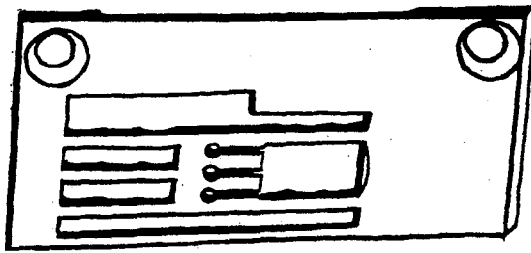

52824B-16

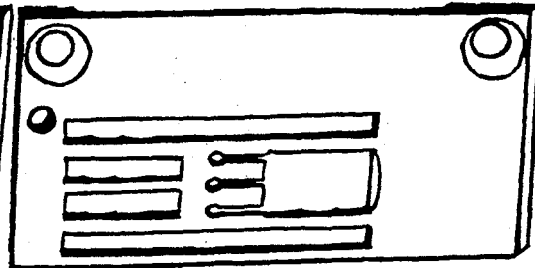

52824D-16

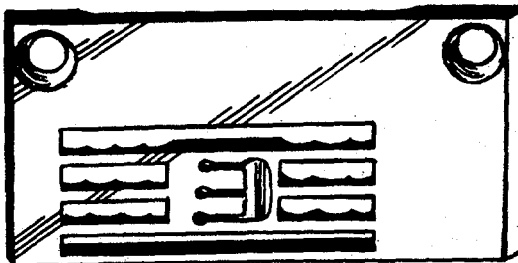

K55752

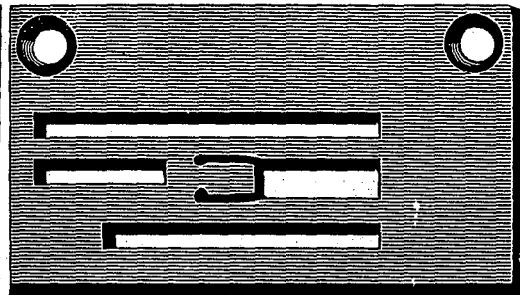

13124 B-10

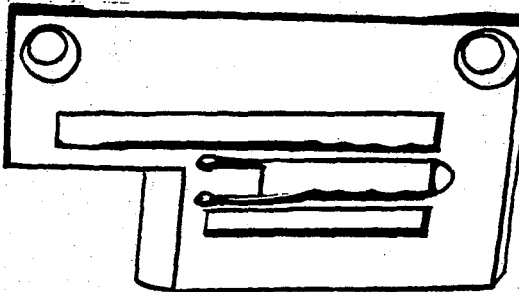

52824F
Specify
Gauge

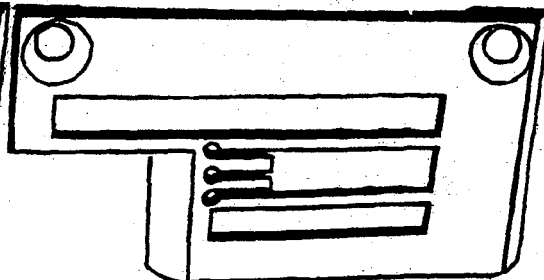

52824 K
Specify
Gauge

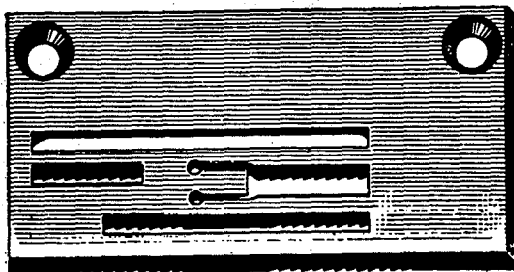

5024M
Specify
Gauge

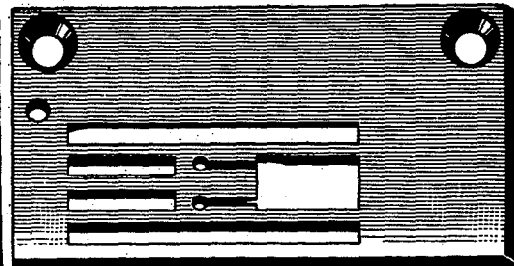

5024B
Specify
Gauge

Plate 2 - Full Size

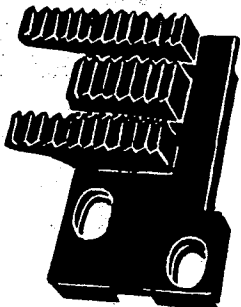
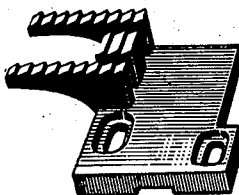
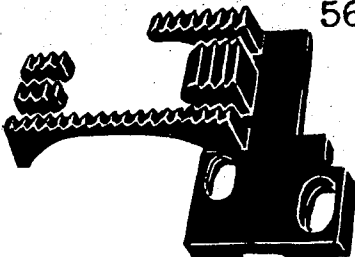
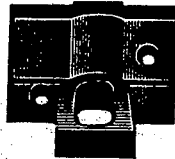
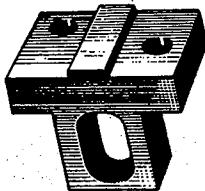
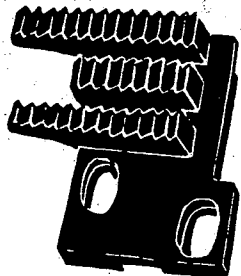
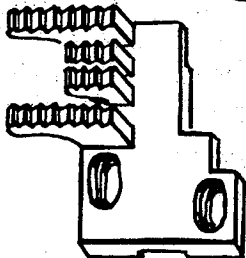
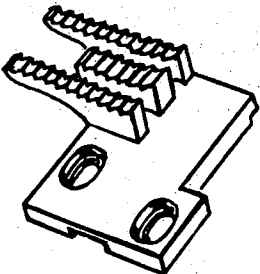
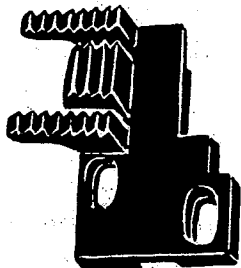
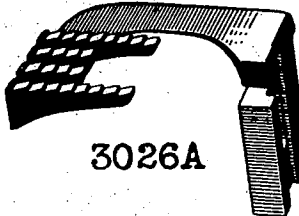
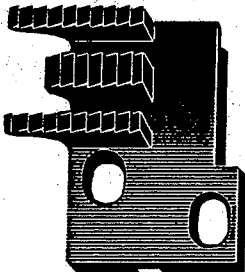
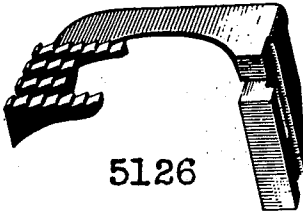
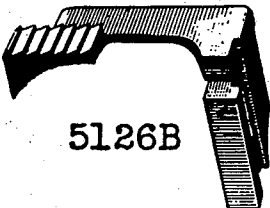
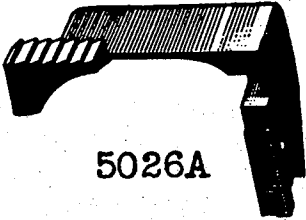
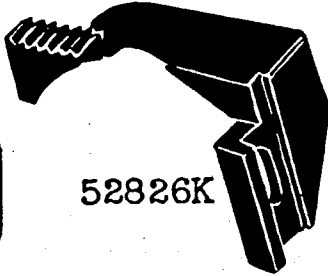
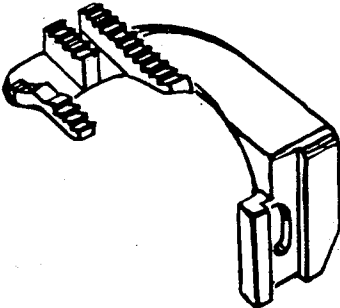
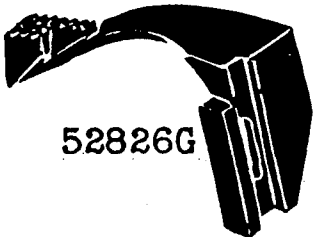

52805B

5105B

52805K

Plate 3 - Full Size

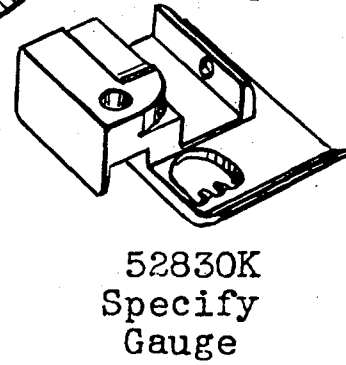
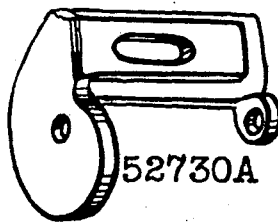
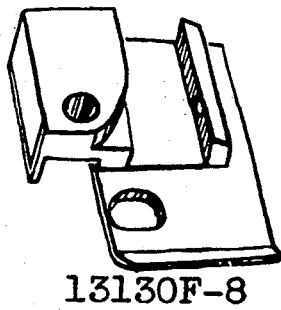
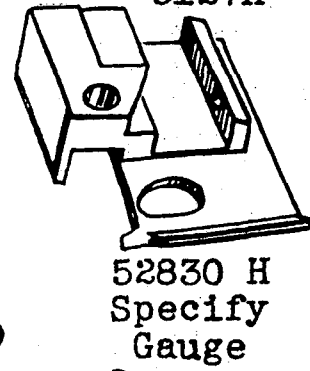
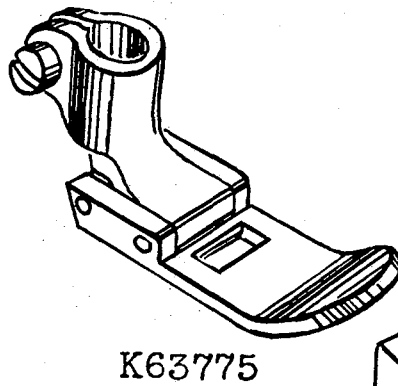
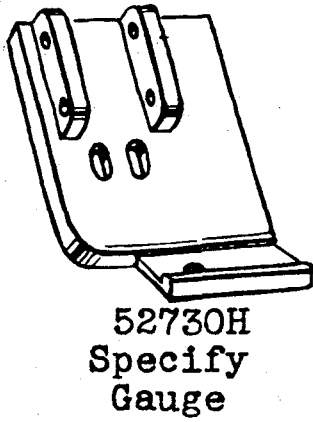
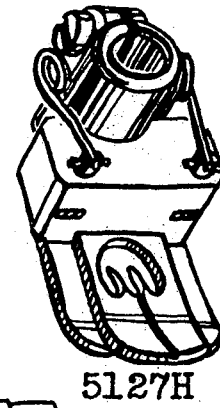
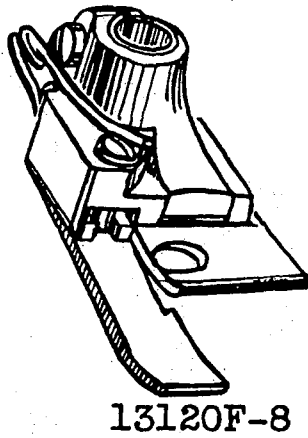
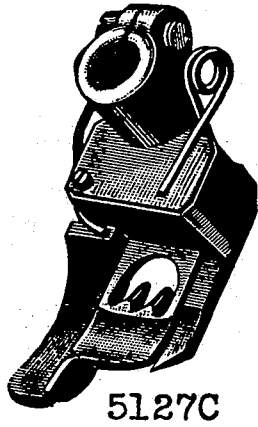
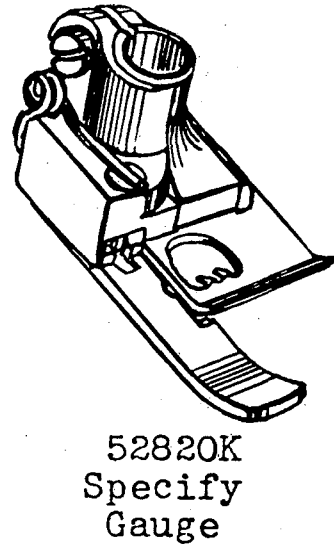
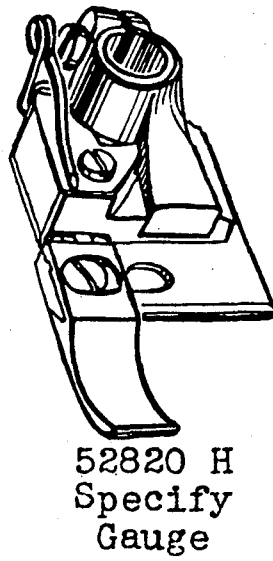
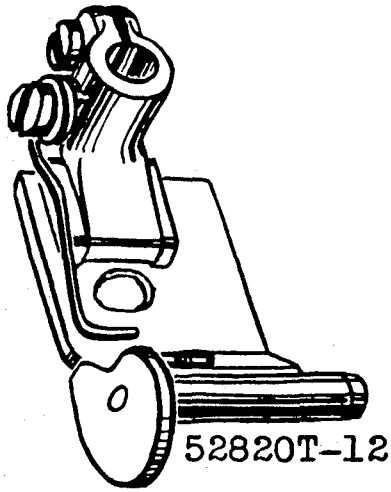
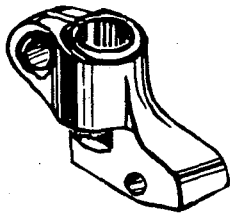
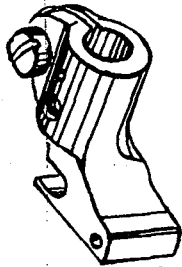

Plate 4 - Full Size



13130B



52730

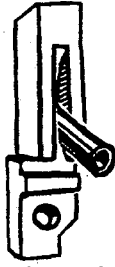

52830A

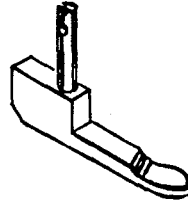

5141R

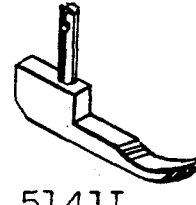

5141L

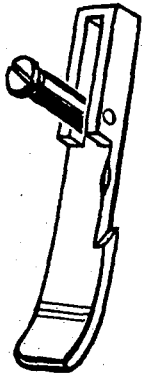

13130A

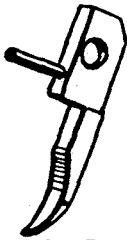

5041

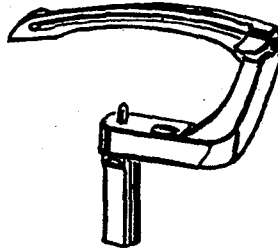

52908 B



52830B

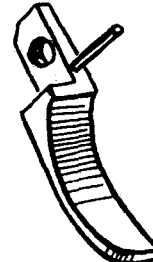

5141

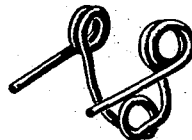

3040



52730C



5140



15480C



51491C



11534

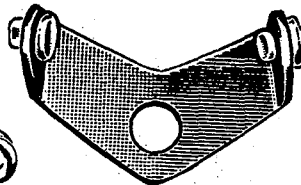

51292D



52710F



52810E



52845A



52A



52842G



158B



158A



51458



41076D



51758

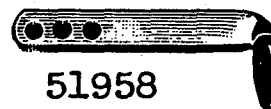

51958



51458A



51958A

Plate 5 - Full Size

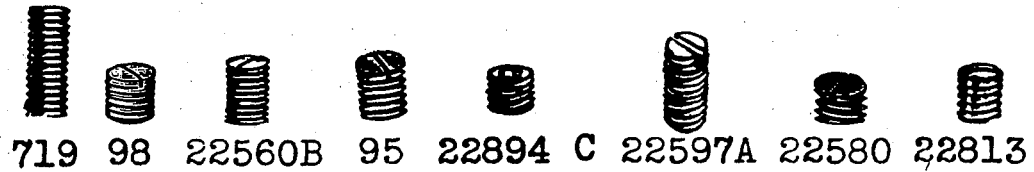
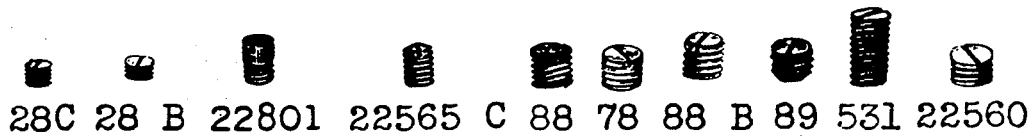

Specify Length

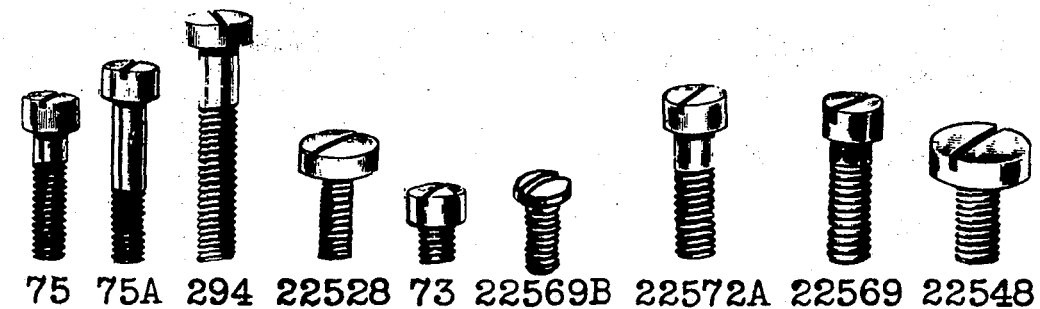
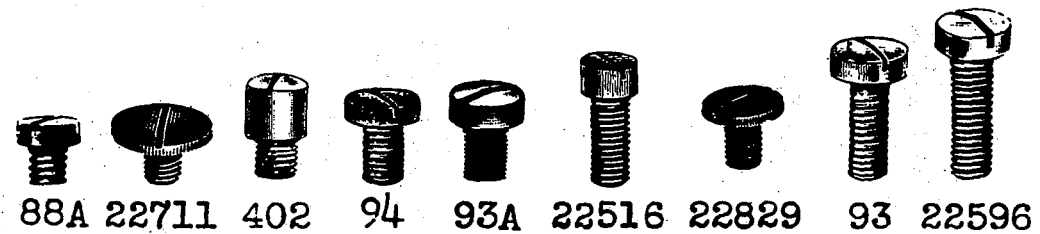
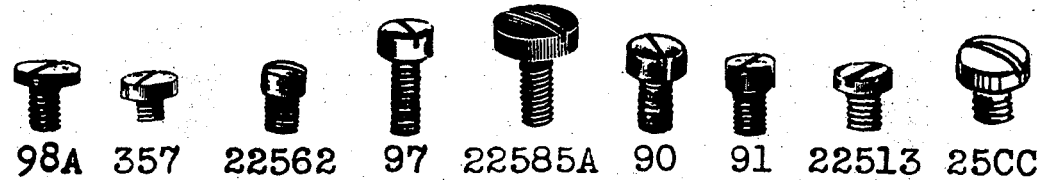
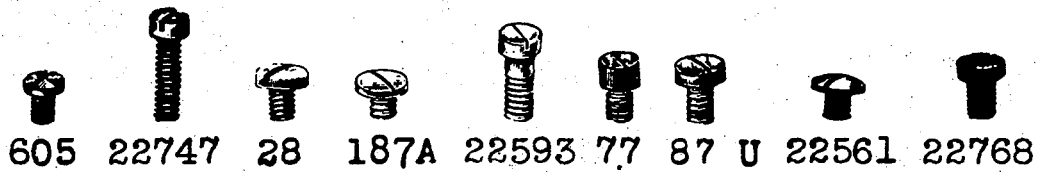
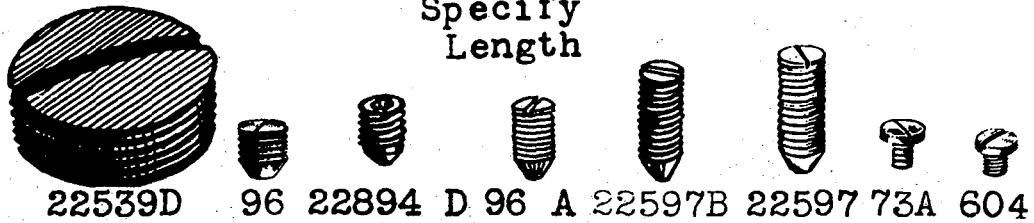

Plate 6 - Full Size



Plate 7 - Full Size

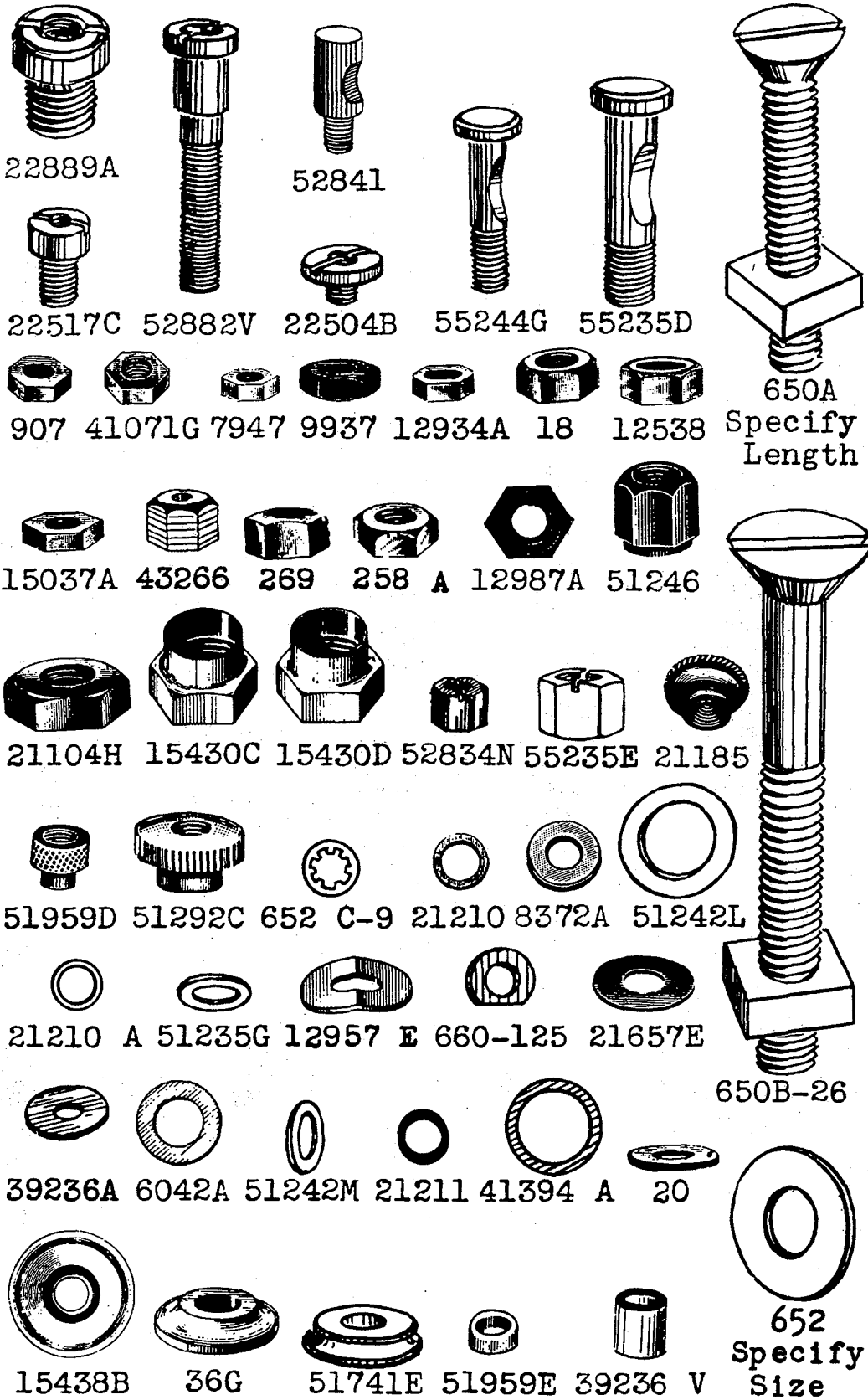

Plate 8 - Full Size



21225
Specify
Measurement



21227V



21227C
Specify
Gauge



43281 L



39236C



129640



1286 A



51236A



1286



51054



51292F-4



39236B



51240A

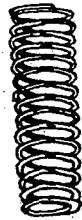

51292F-1

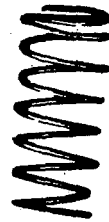

51292F-2



51292F-8

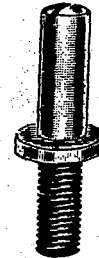

15447A



52835 K

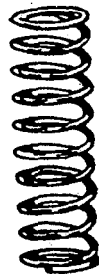

51292F-5

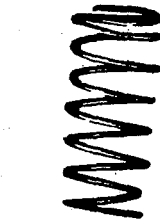

51292F-2



51292F-8



15438C

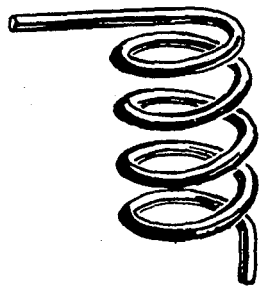

52875G

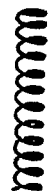

1286B

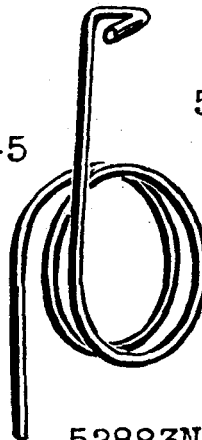

52883N



51959C



110-2

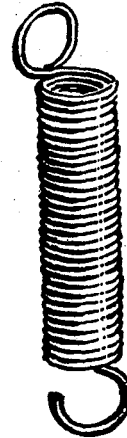

51283G



11663

Plate 9 - Full Size

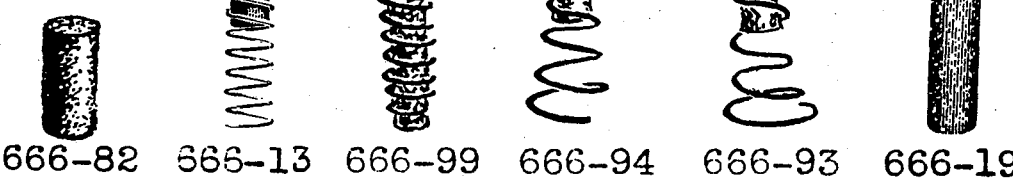
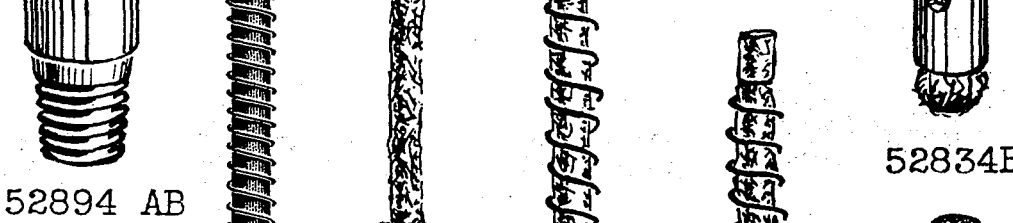
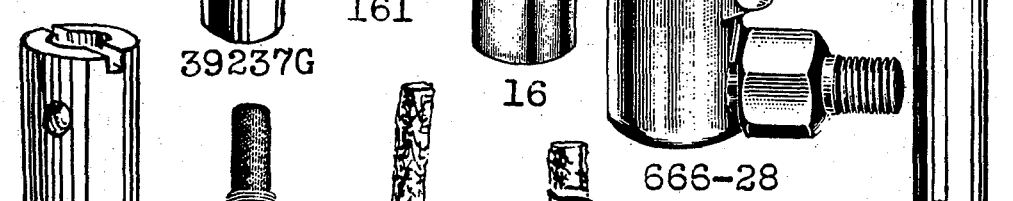
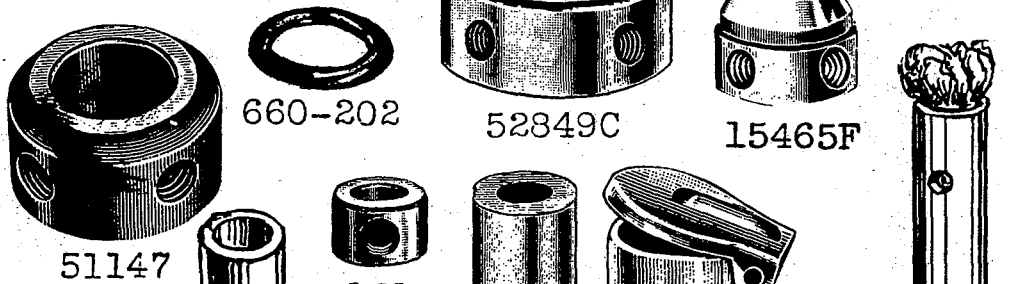
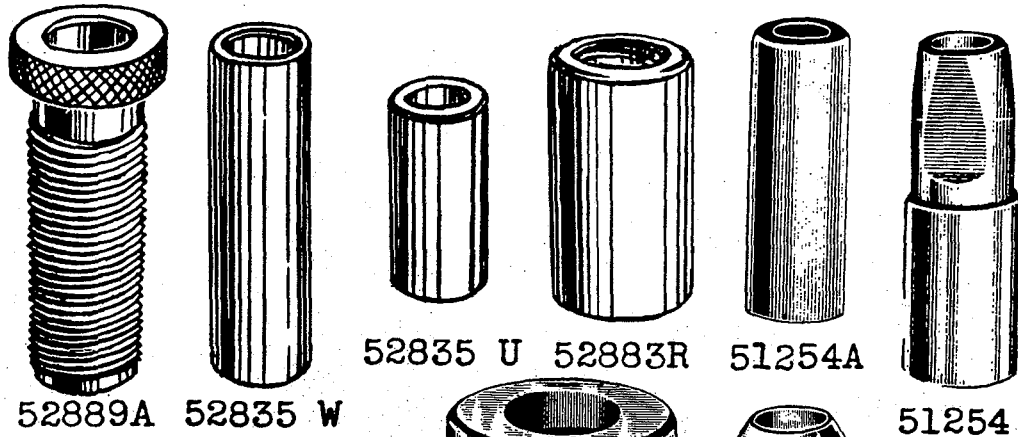
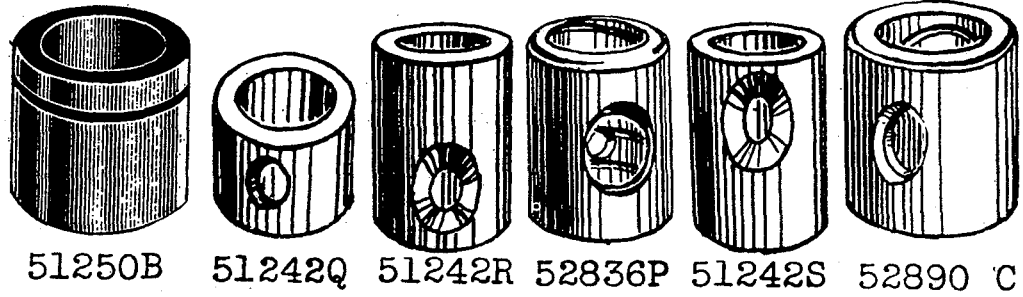

Plate 10 - Full Size

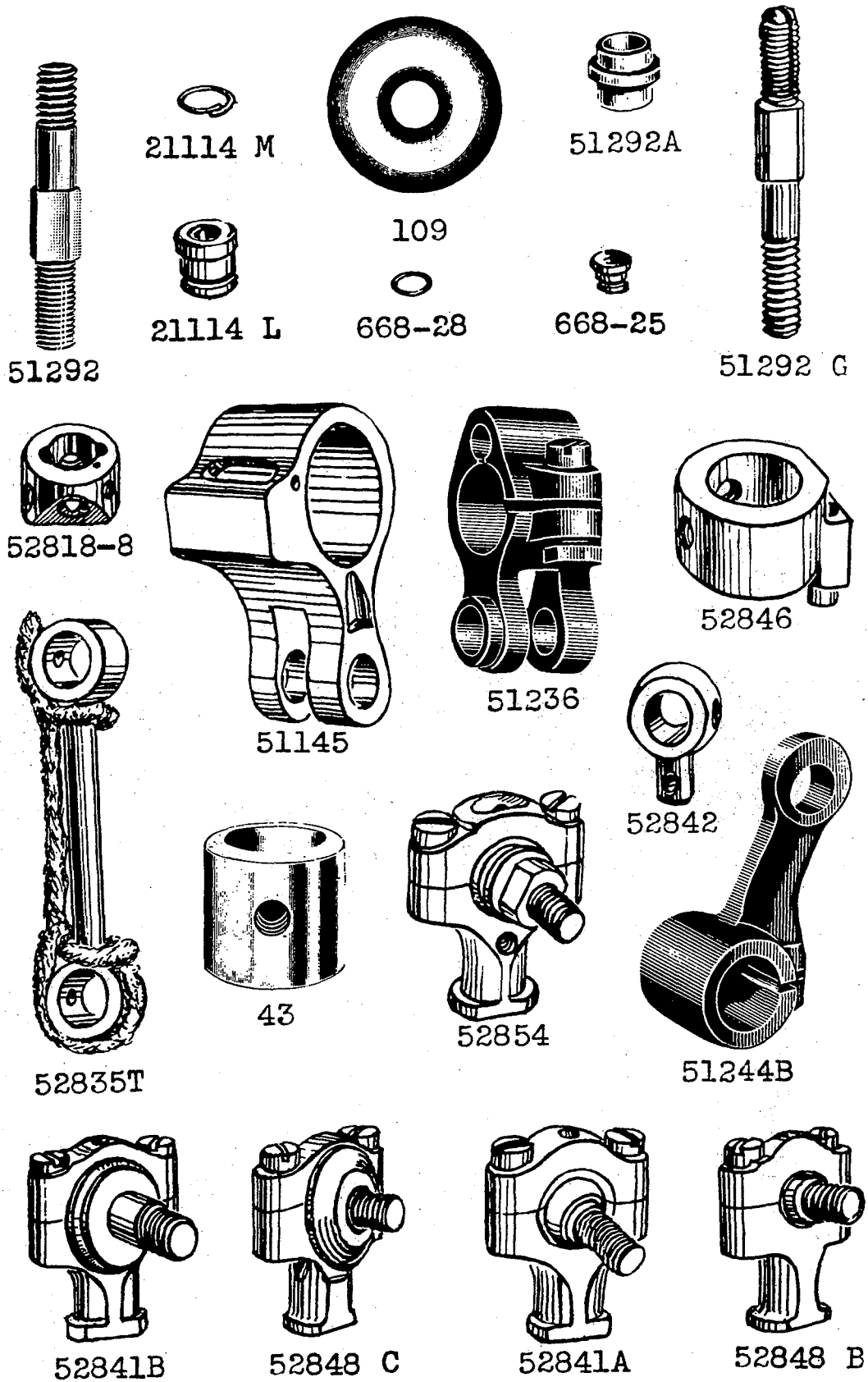
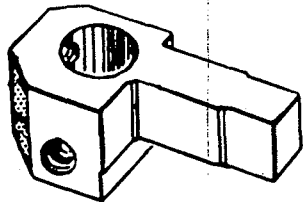
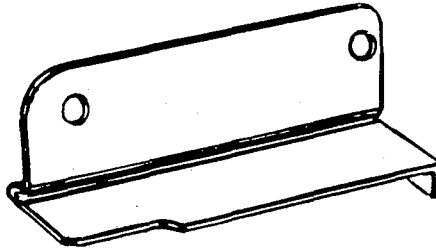

Plate 11 - Full Size



52883P



52875J

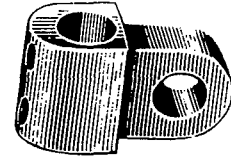

35759



51243C

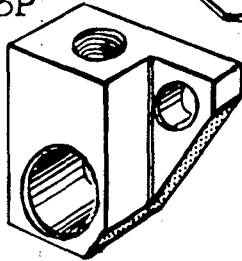

52883K



41255 B

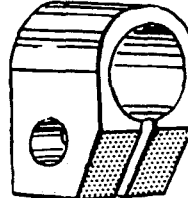

55244F



35731A

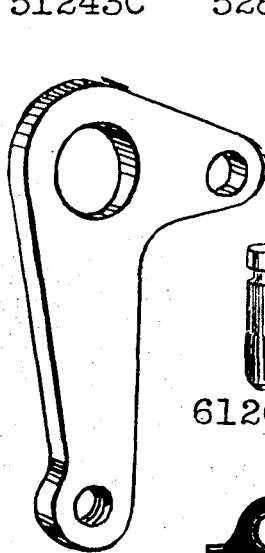

52883M

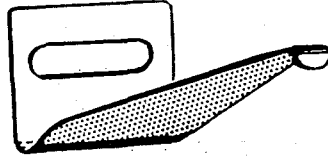

52894L



52835 S



61267G

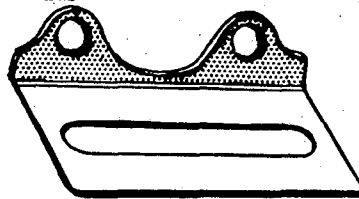

52894M

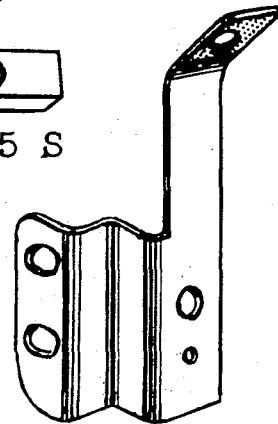

52894N



1248

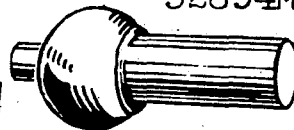

55243 A

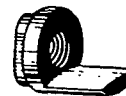

8372



52888B

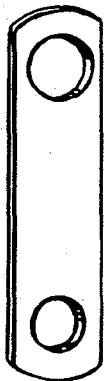

52883Q



52875B

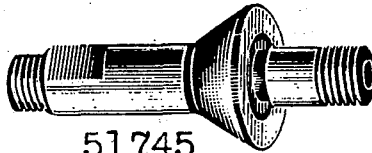

51745



51296



51296A



39132V



51283F



52835 G

Plate 12 - Full Size

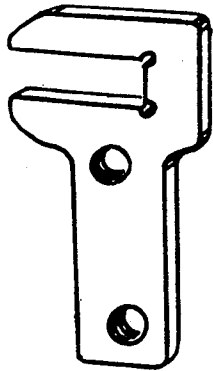

52835 Q

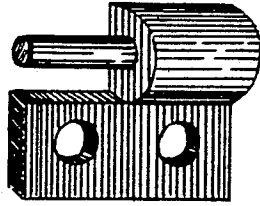

52885G

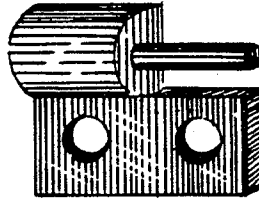

52885H

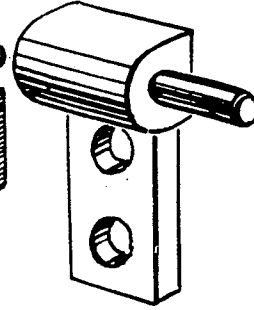

52885J



39237D



51236B



21351

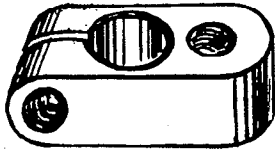

21657Y



39236

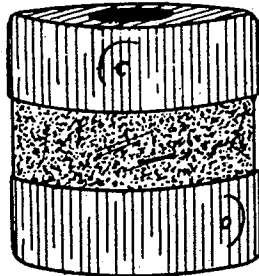

51295



23195

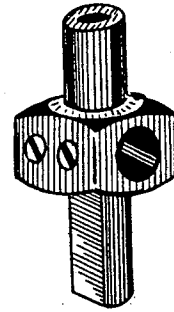

39237

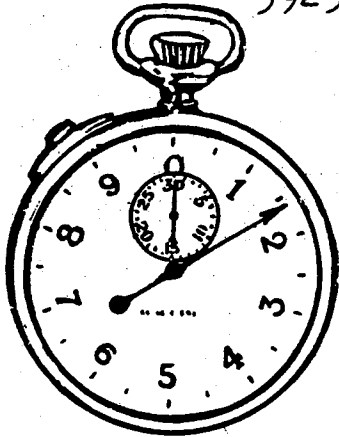

WA15 A



35582B

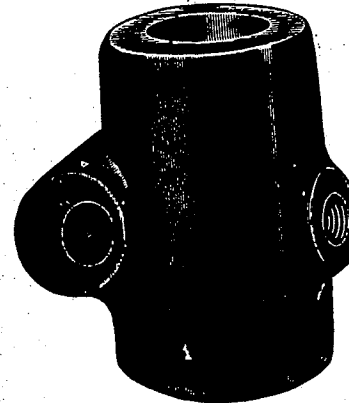

21217A



660-142



660-128

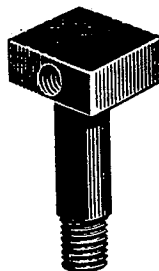

51236C



V118



21198J



21350



51959B



751A



660-127

Plate 13 - One-Half Size

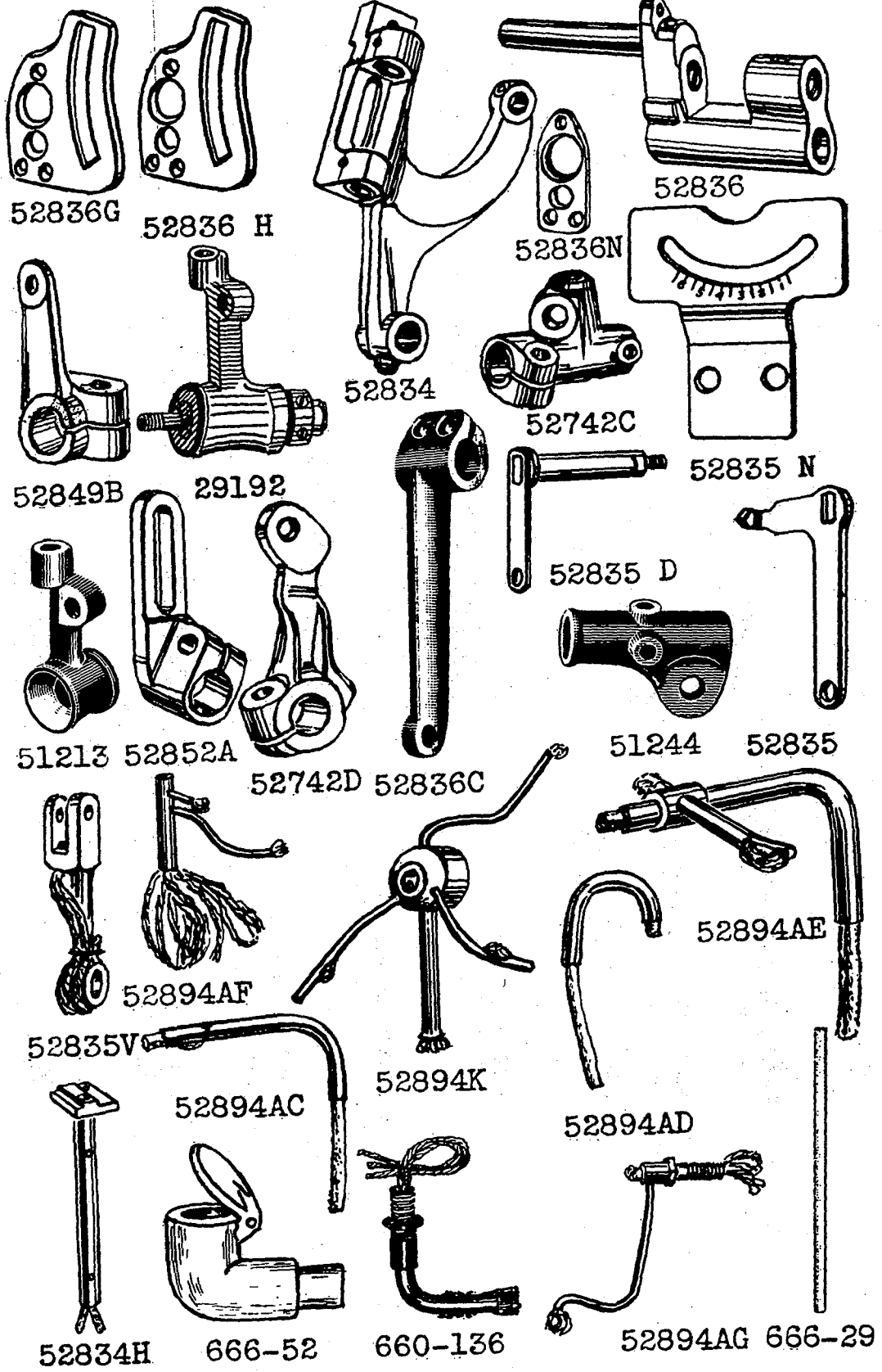
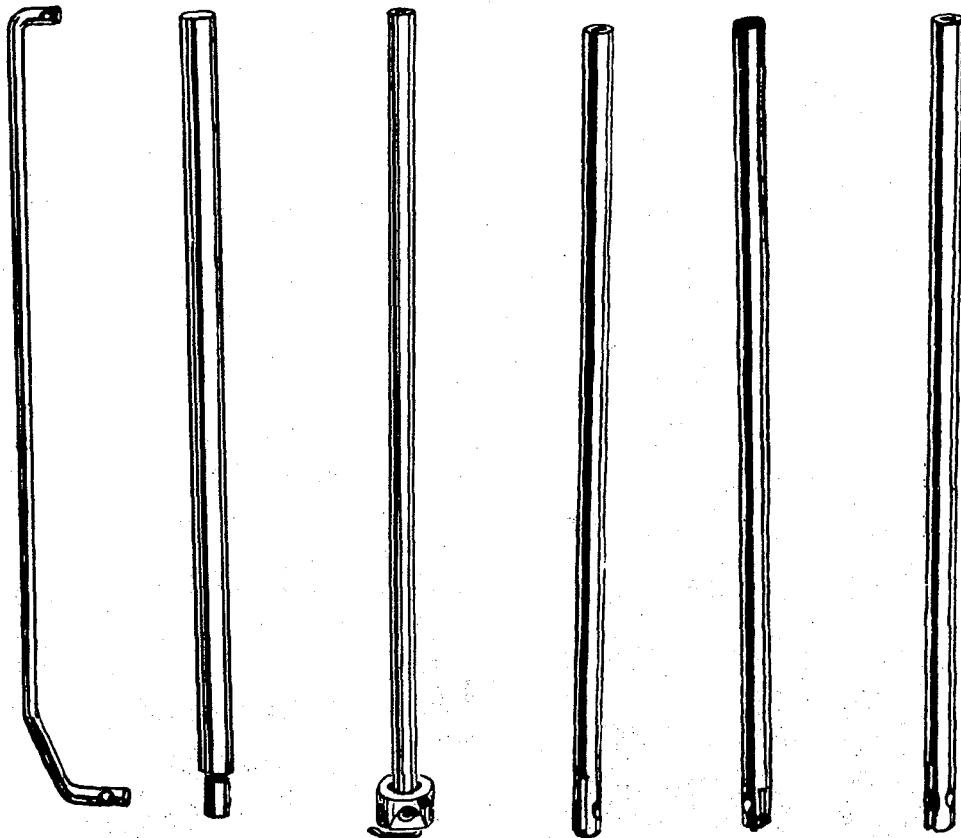
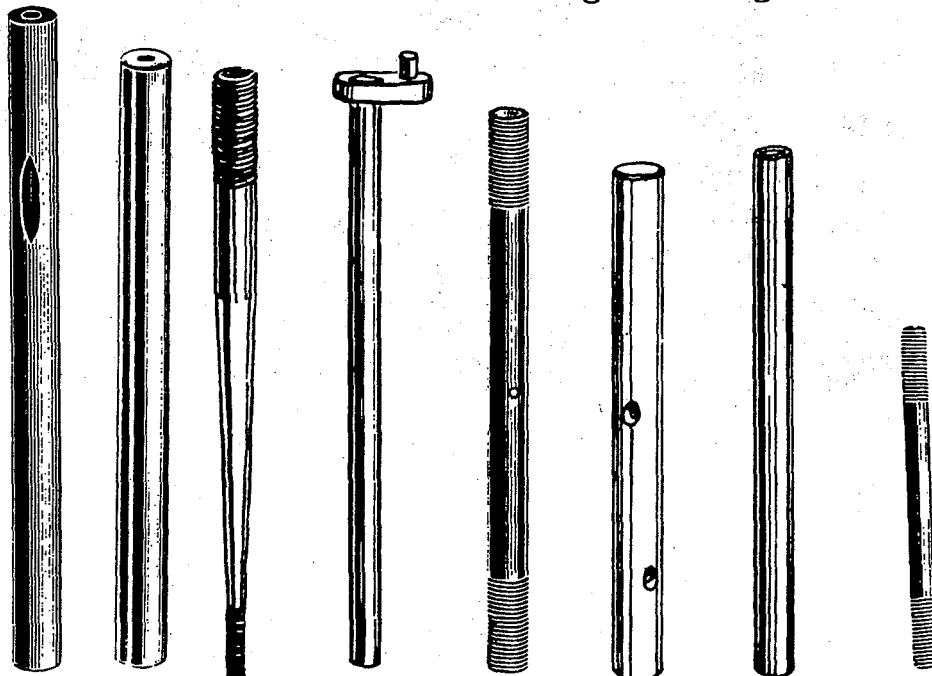

Plate 14 - One-Half Size



52883L 52888A 29264S-16 52817 52717B 52817 E
 Specify Gauge Specify Gauge Specify Gauge



51244A 8 52816 21657W 5121651242P 21657X 35741A

Plate 15 - One-Half Size

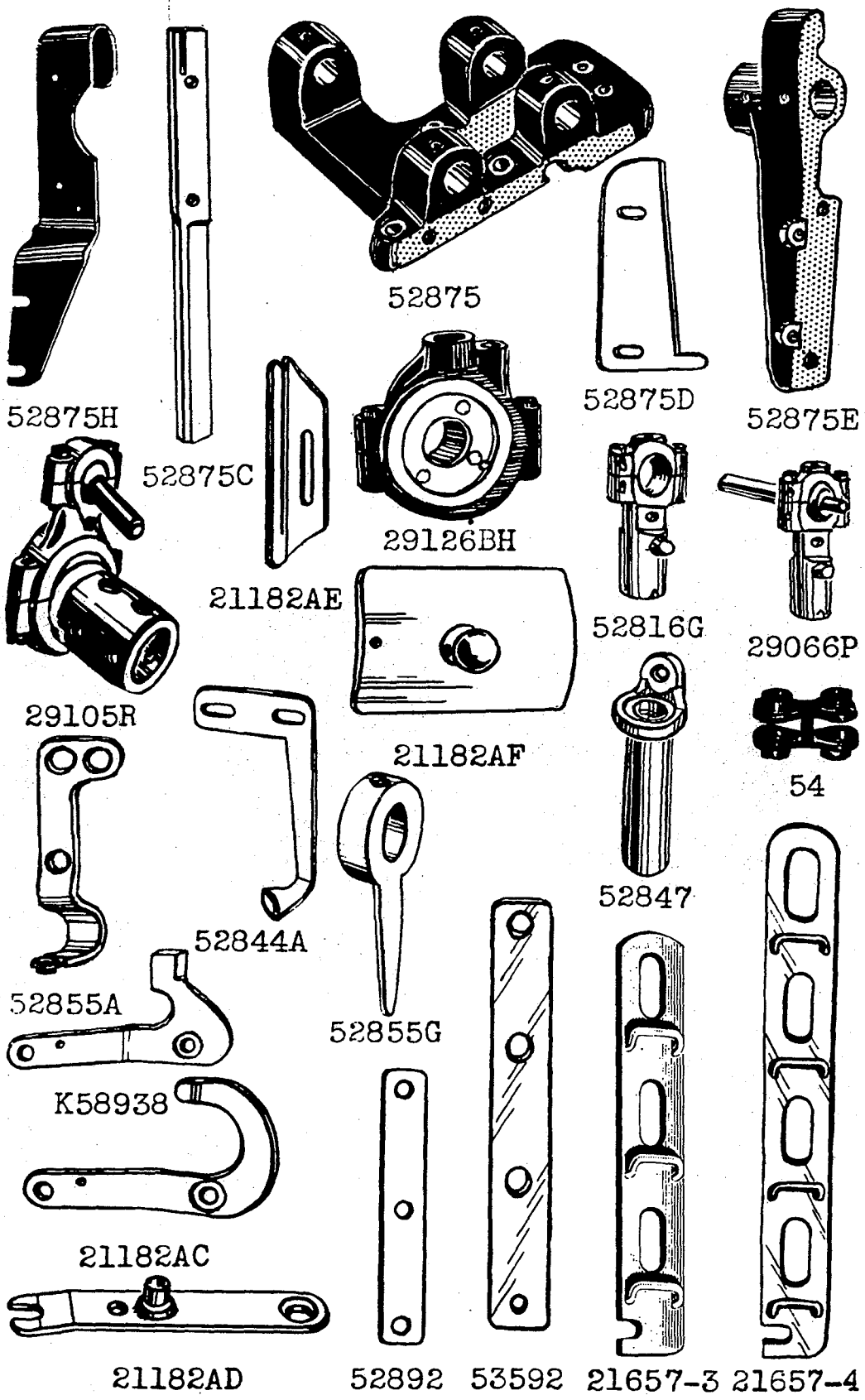

Plate 16 - One-Half Size

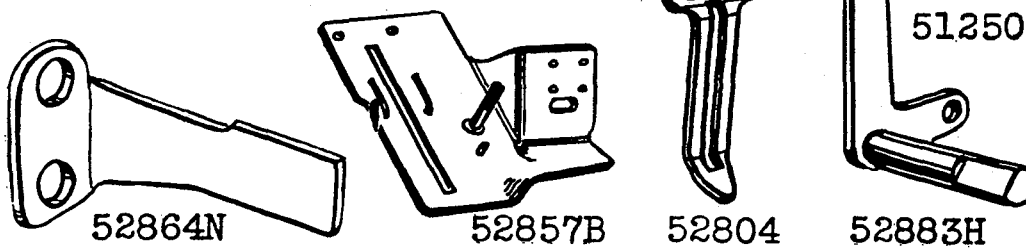
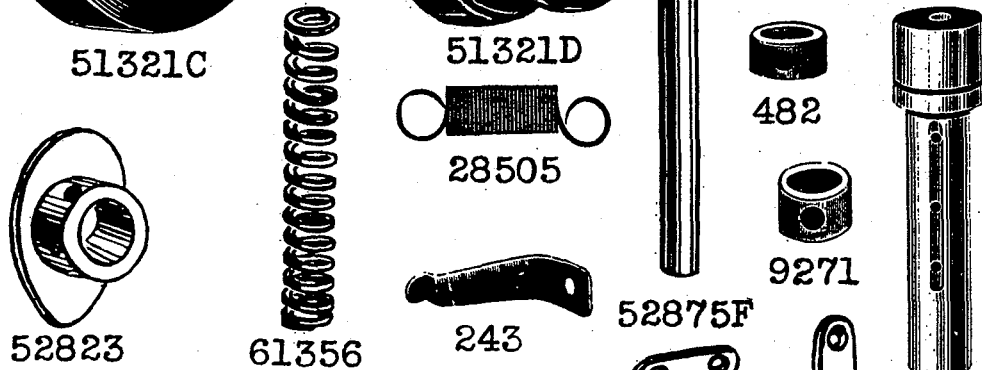
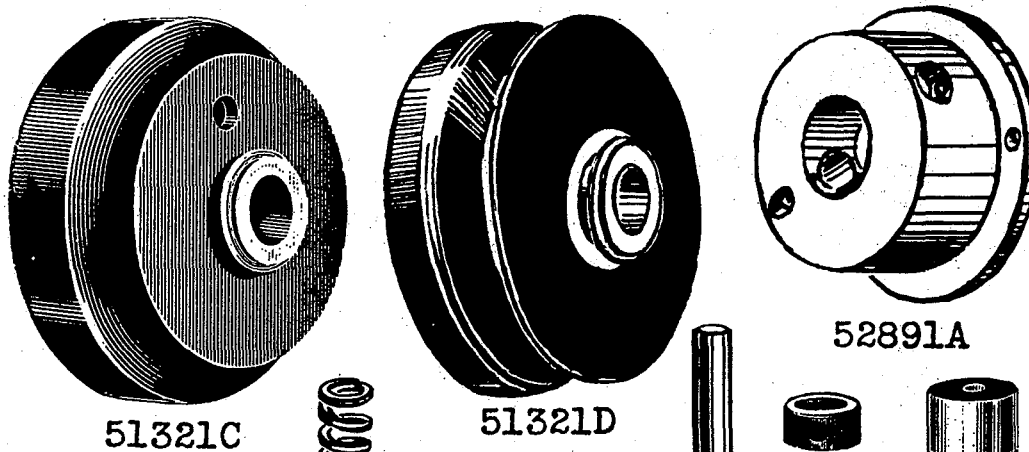
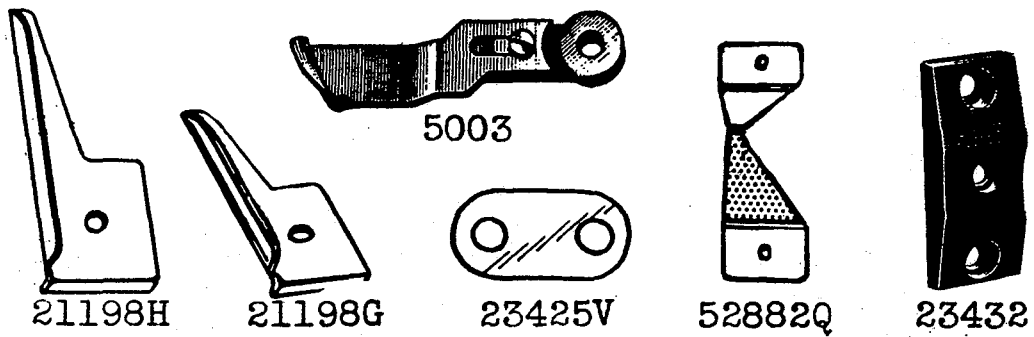
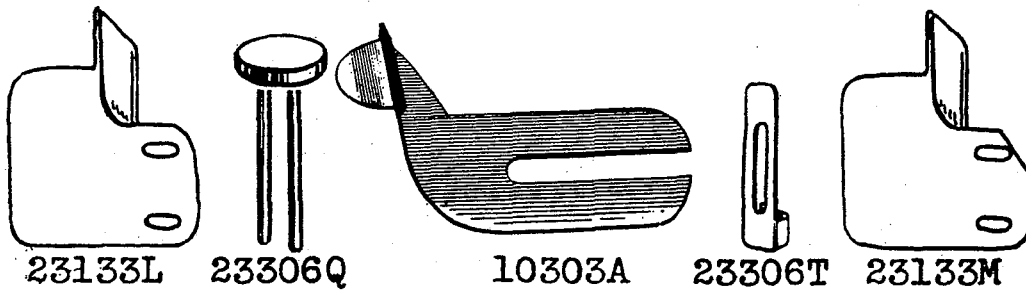
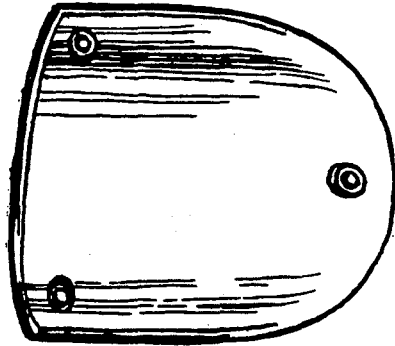
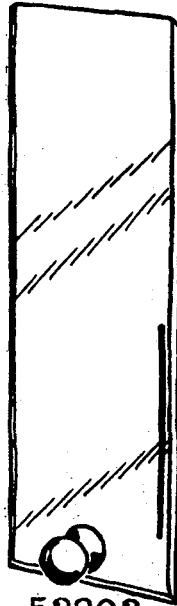

Plate 17 - One-Half Size



52882 N



52802

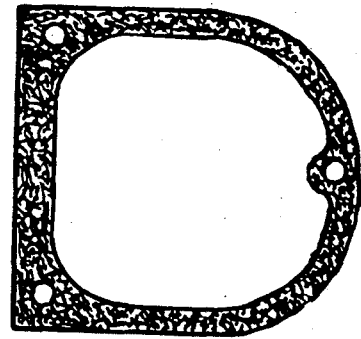

52882 P

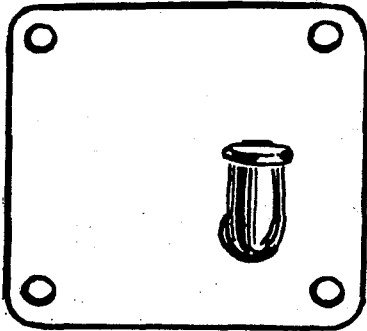

52882T

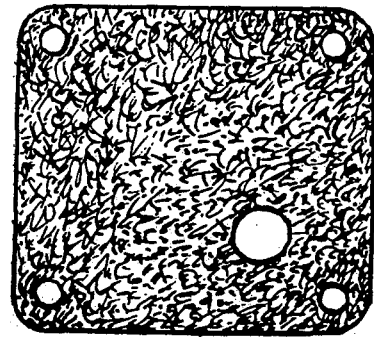

52882U

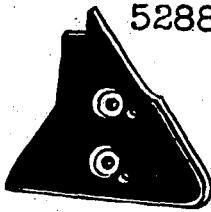

52864R

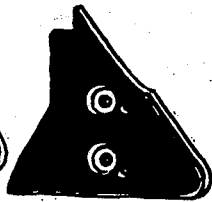

52864S



52802B



21114U



21114T



423

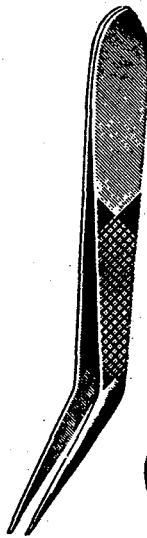

118B

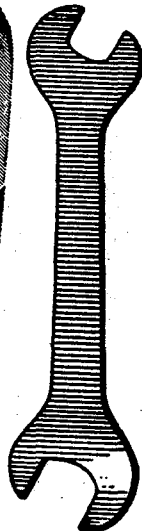

21388R

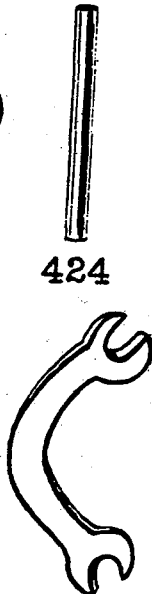

21388W



424

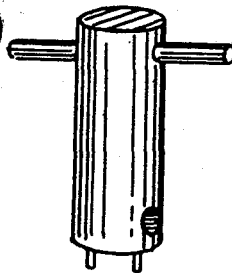

21388Z



21207



21388



21388N

Plate 18 - One-Half Size

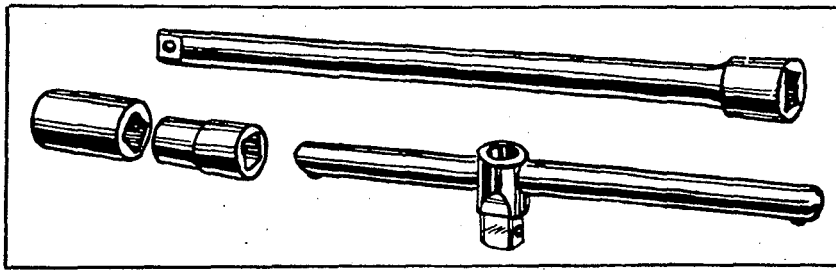

21388AE

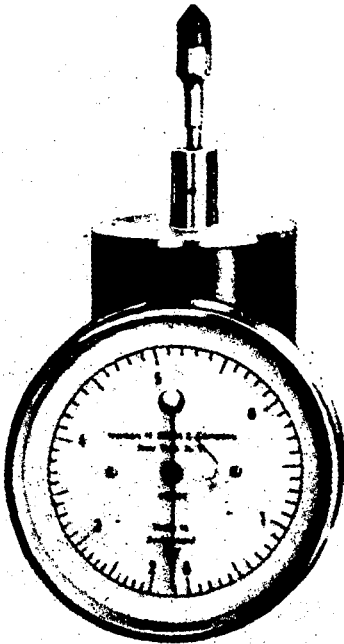

TA55A

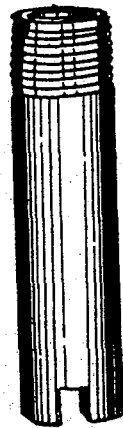

43294D

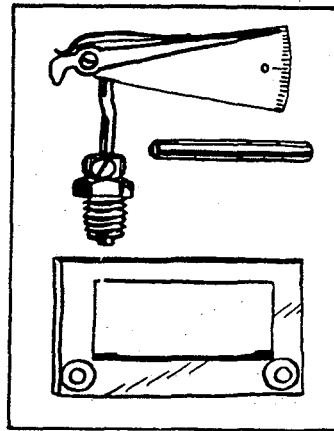

21227R

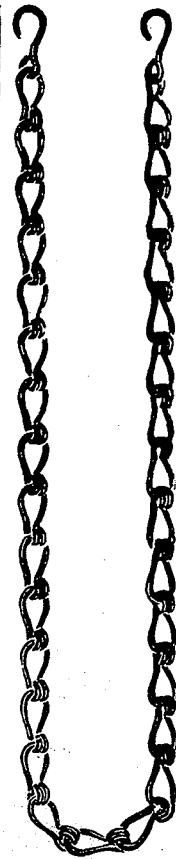

421



753

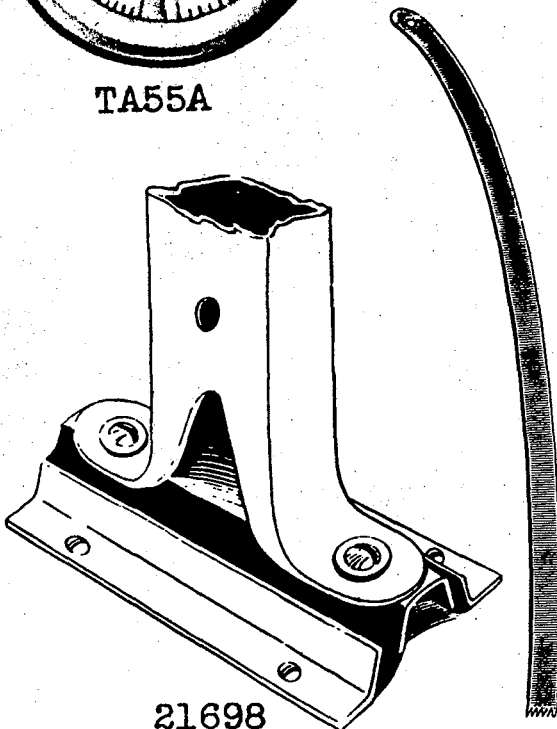

21698
Specify Length

23279D

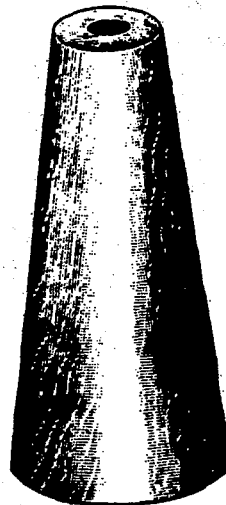

21145

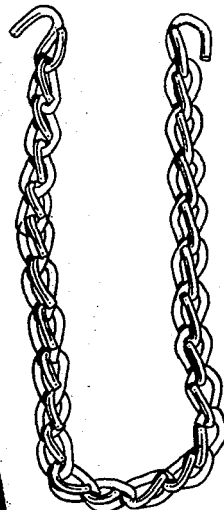

421 C
Specify Length

Plate 19 - One-Fourth Size



K57696



K53501



K62809



K59055



K55789



K64050



K64049



23406N

Specify
Width



K56821



23406L

Specify
Width



K63004



23406M

Specify
Width



K63210



51215

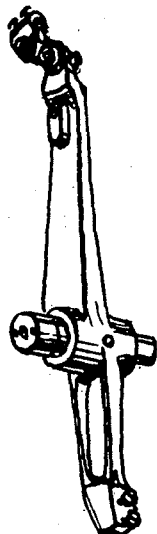

H 29348



N 29476AY



21198

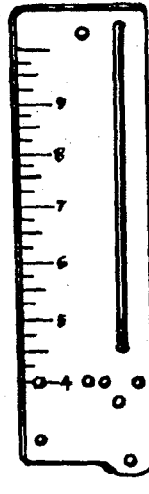

E 21198F



K57904

Plate 20 - One-Fourth Size

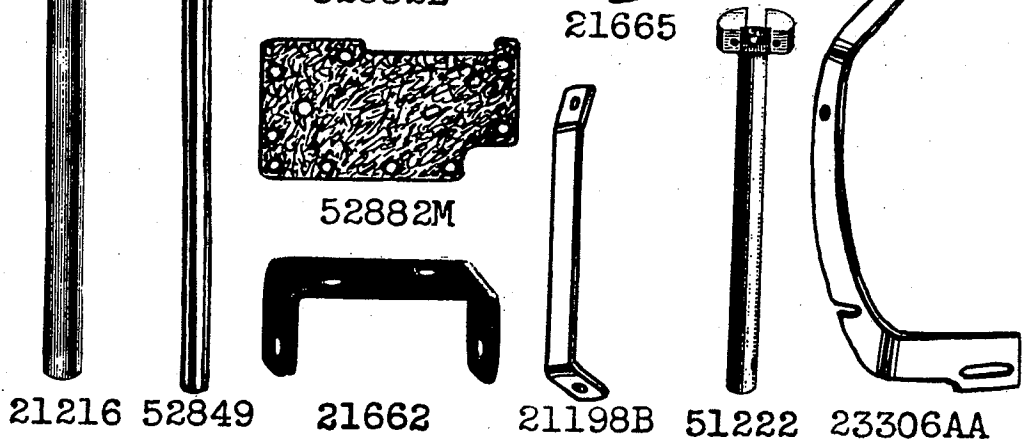
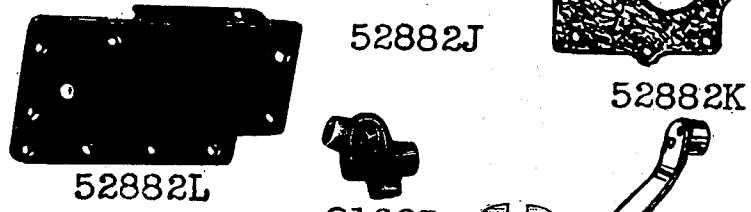
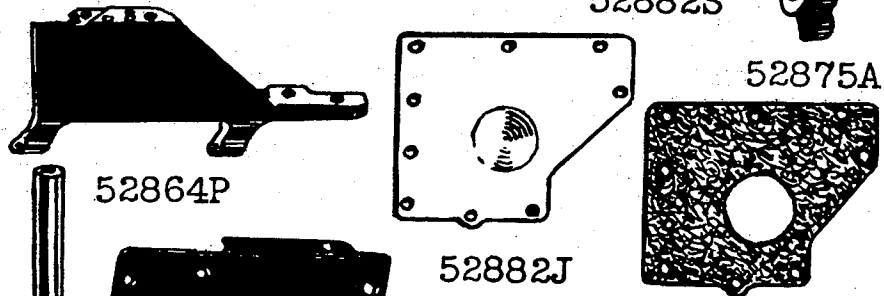
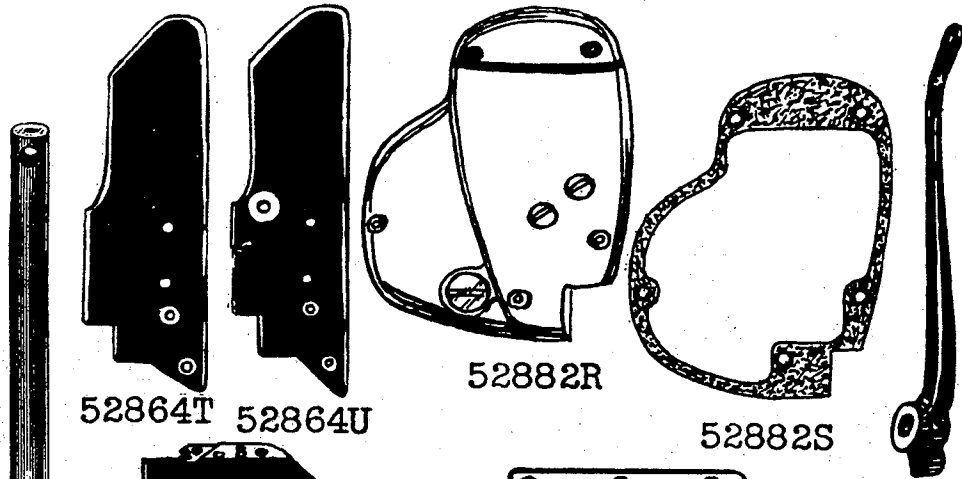
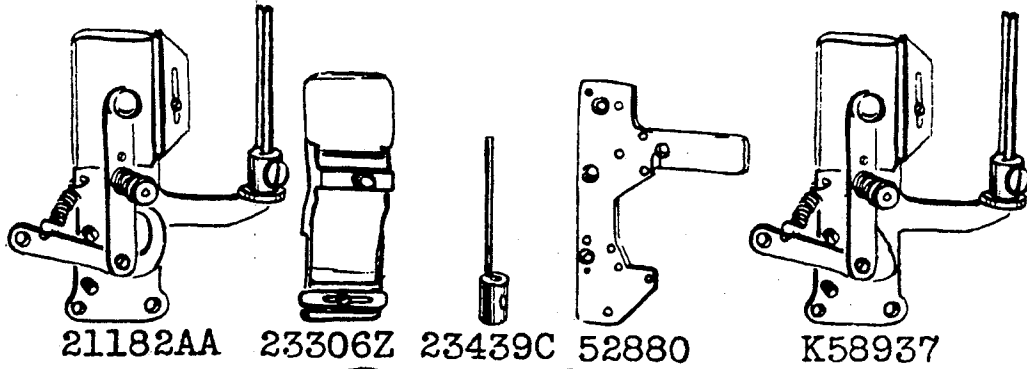
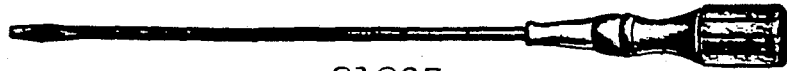

Plate 21 - One-Fourth Size



21204



21203



21205A

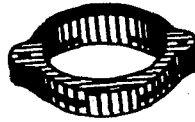

43294A



21202

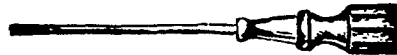

21201

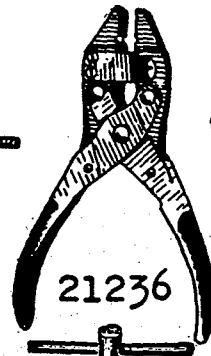

21236



Y506
Specify
Size

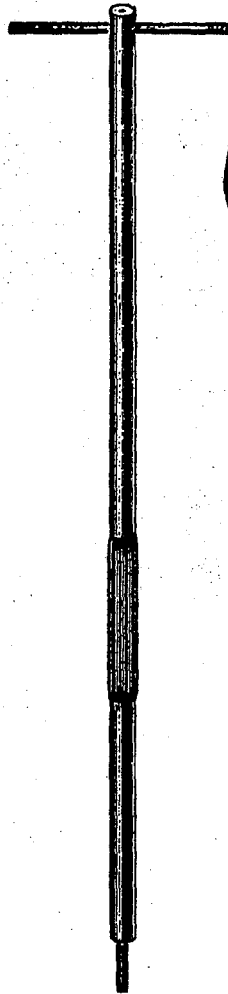

Y505
Specify
Size



Y502
Specify
Size

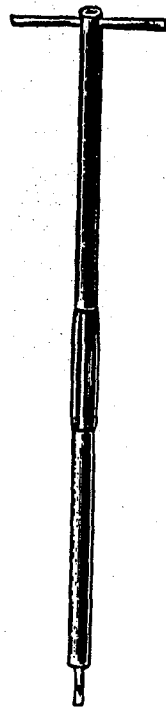

Y500
Specify
Size

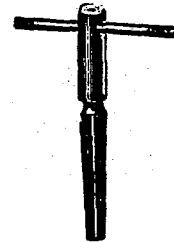

Y802

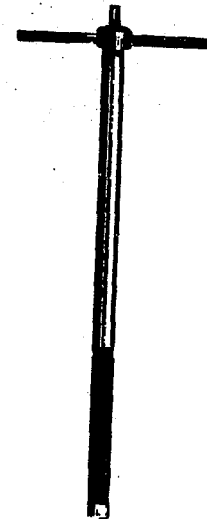

Y503
Specify
Size

Plate 22 - One-Fourth Size

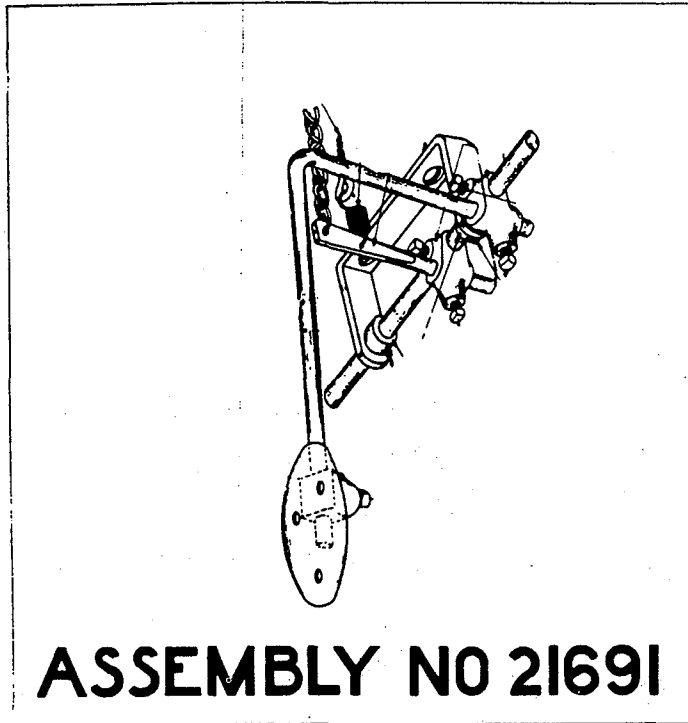

21679

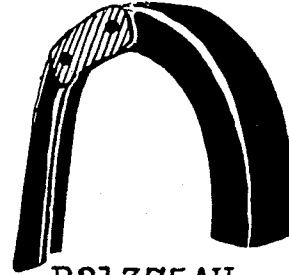

B21375AH



21664

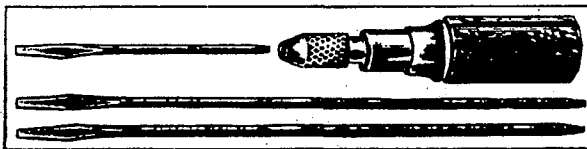

21208



422

51294A

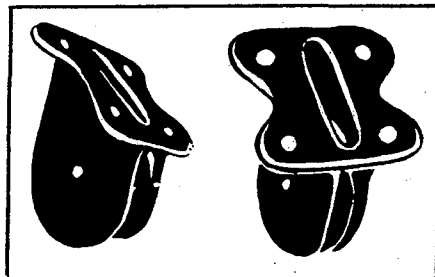

660-159

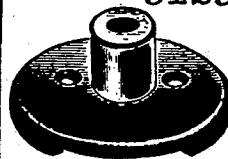

21217

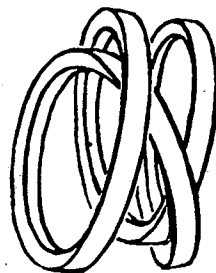

21262H

Specify Length 21661

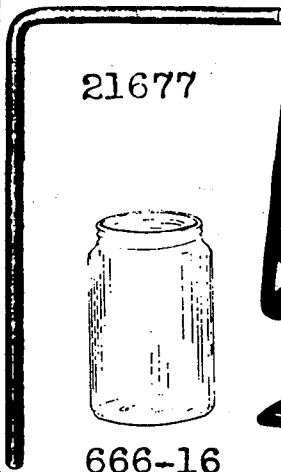

21677



666-16

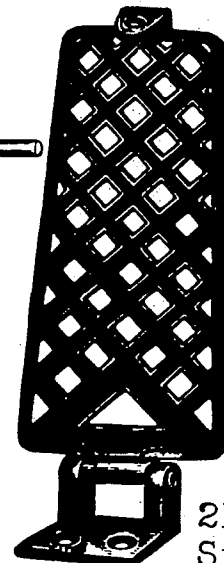

21104B
Specify Length

29402

Plate 23 - One-Eighth Size

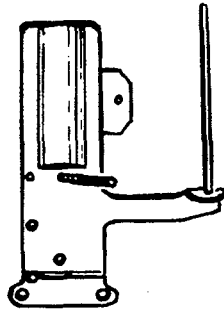

21182AB

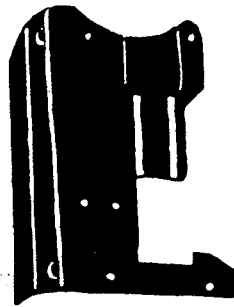

52801A

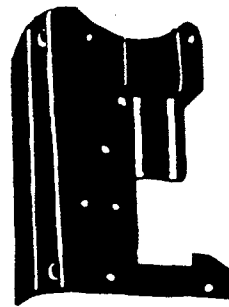

52801B

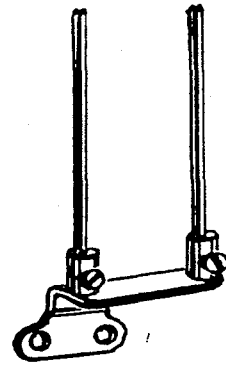

23439D



B52885

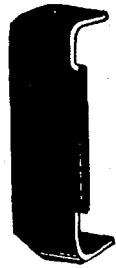

B52885A

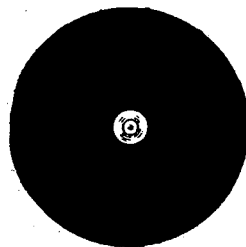

21169E

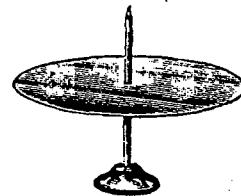

21169D



21169F



23439E



752



21114 A

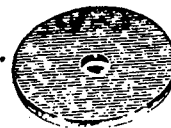

21104V



21388X

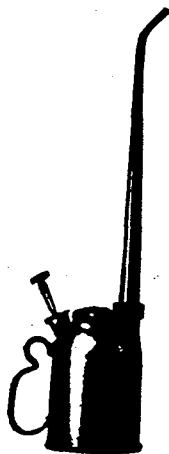

0I-19

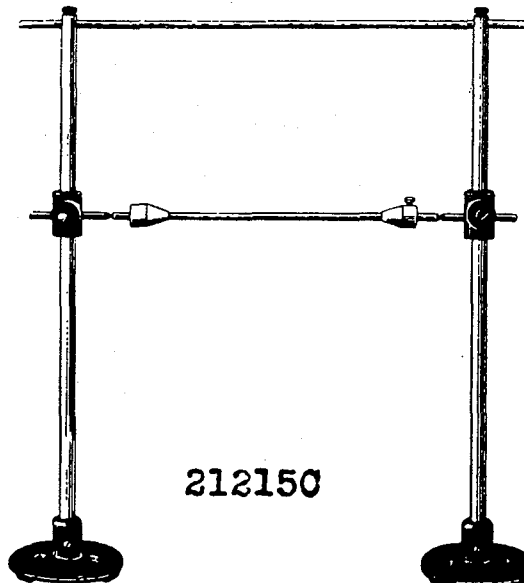

212150



21102B

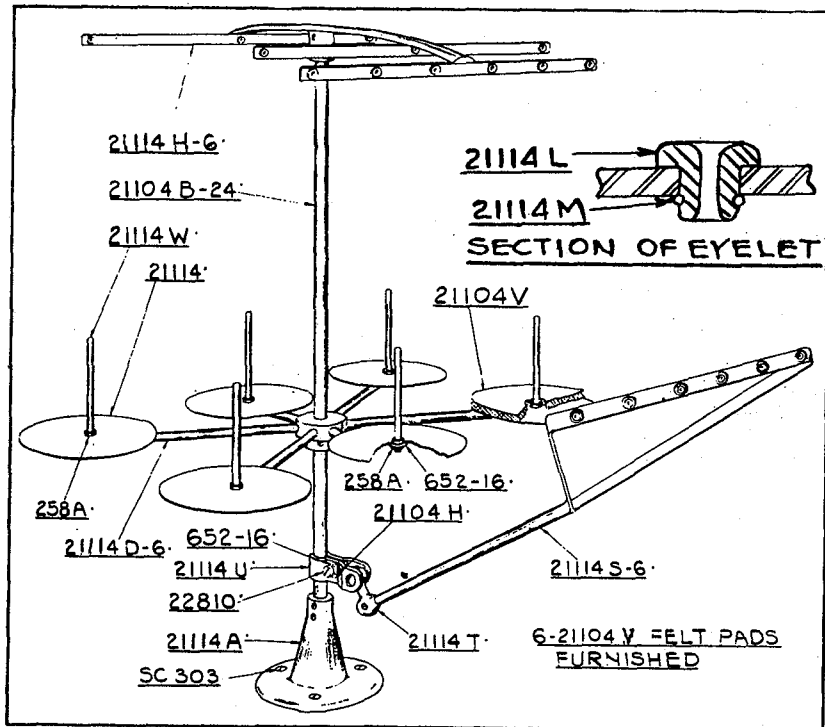

ASSEMBLY N^o 2110IH-6

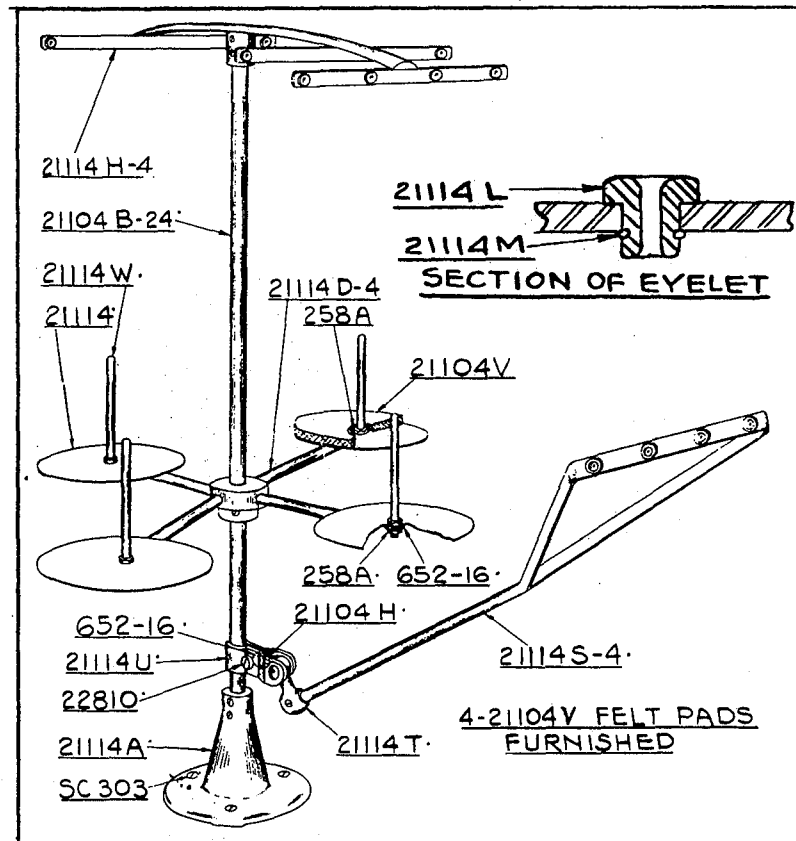

ASSEMBLY N^o 2110IH-4

LIST OF PARTS

Symbol to Order By	The figures in the last column refer only to the plates illustrating the parts and are not to be used in ordering. Prices furnished on application.	Plate No.
8	Feed Rocker Shaft - - - - -	14
WA15 A	Stop Watch- - - - -	12
16	Feed Crank Link Ferrule - - - - -	9
18	Looper Connecting Rod Nut, right thread, also for Nos. 51240 A, 52841 A, 52854, 55244 G -	7
OI-19	Pressure Pump Oil Can, 1 1/2 pints capacity -	23
20	Feed Crank Stud Washer; also for Nos. 51758, 55244 G - - - - -	7
25 C	Screw, 9/32 long, for cloth plate attachments	6
25 S	Screw, for folder clamp on Styles 52800 P, 52800 R, 52800 S, 52800 U, 52800 V, 52800 W; also for Nos. 21198 E, K57904- - -	6
25 CC	Screw, for folders on Styles 52800 P, 52800 R, 52800 S, 52800 U, 52800 V, 52800 W; also for No. 8372- - - - -	5
28	Screw, for cast-off plate - - - - -	5
28 B	Screw, for needle holder thread guide - - - - -	5
28 C	Set Screw, for middle needle on Styles 52800 M, 52800 N, 52800 W, 52800 X- - - - -	5
36 G	Rear Spreader Connecting Ball Joint Stud Washer- - - - -	7
43	Feed Lift Eccentric; also looper avoid eccen- tric (spot screw No. 22894 D)- - - - -	10
52 A	Frame Thread Eyelet (screw No. 98 A)- - - - -	4
54	Needle Lever Link - - - - -	15
TA54	Hand Tally- - - - -	-
TA55 A	Hand Tachometer, 4 speed type, 90 to 12000 R.P.M.- - - - -	18
57 WD	Presser Foot Bottom Spring Stud, for Style 52800 T - - - - -	6
69 FD	Screw, square head, cup point, 5/16 diameter, 18 threads per inch, 5/8 long, for knee press plate; also for No. 21665- - - - -	6
73	Set Screw, for looper - - - - -	5
73 A	Screw, for looper needle guard; also for Nos. 13130 A, 41076 D- - - - -	5
75	Screw, lower, for feed rocker segment slot plate on Styles 52800 M, 52800 N, 52800 P, 52800 R, 52800 S, 52800 T, 52800 U, 52800 V, 52800 W, 52800 X- - - - -	5
75 A	Screw, for needle lever connecting rod bear- ing, lower- - - - -	5
77	Set Screw, for feed crank link pin; also for upper needle lever link pin - - - - -	5
78	Set Screw, for lower needle lever link pin- -	5
80	Screw, countersunk head, for cloth plates - -	6
87	Screw, countersunk head, 1/4 inch long, for throat plates - - - - -	6
87 U	Screw, for spreader - - - - -	5
88	Screw, for looper rocker cone; also for Nos. 161, 52818-8, 52846 - - - - -	5

LIST OF PARTS

Symbol to Order By	The figures in the last column refer only to the plates illustrating the parts and are not to be used in ordering. Prices furnished on application.	Plate No.
88 A	Set Screw, for needle bar- - - - -	5
88 B	Set Screw, for needles on Styles 52800 P, 52800 R, 52800 S, 52800 T, 52800 U, 52800 V; also for right and left needle on Styles 52800 M, 52800 N, 52800 W, 52800 X - - - - -	5
89	Set Screw, for feed rocker - - - - -	5
90	Screw, for differential feed dogs; also for Nos. 43281 K, 52844 A, 52864 R, 52864 S, 52882 Q, 52894 L, 52894 M, 52894 AC, 52894 AD, 52894 AE - - - - -	5
91	Clamp Screw, 3/8 inch long, for presser feet -	5
93	Screw, for pulley guard; also for Nos. 21198 E, 51244 B, 52875 D, K57904- - - - -	5
93 A	Screw, for folder support hinged bracket plat- form on Styles 52800 M, 52800 N, 52800 T, 52800 X- - - - -	5
94	Screw, for measuring gauge brace; also for No. 23306 Z- - - - -	5
95	Set Screw, for main shaft collar; also for Nos. 29126 BH, 52849 C, 52855 G, 52875 A, 52875 E	5
96	Spot Screw, for shielded disc take-up; also for No. 51244 - - - - -	5
96 A	Spot Screw, for looper lever rocker- - - - -	5
97	Screw, for needle lever ball stud fork - - - - -	5
97 A	Screw, for looper drive connection; also for Nos. 52816 G, 52841 A, 52841 B, 52848 B, 52848 C, 52854 - - - - -	6
98	Screw, for feed rocker shaft collar; also for Nos. 9271, 51244 - - - - -	5
98 A	Screw, for frame thread eyelets- - - - -	5
109	Tension Disc - - - - -	10
110-2	Tension Spring, for intermittent strip tension on Style 52800 P - - - - -	8
118 B	Thread Tweezer - - - - -	17
V118	Tap, marked "X-2", for plus size cloth plate screw No. 22521- - - - -	12
136	Screw, for tape clipper assembly - - - - -	6
158 A	Frame Thread Eyelet, with three holes, for Styles 52800 M, 52800 N, 52800 W, 52800 X (screw No. 98 A) - - - - -	4
158 B	Frame Thread Eyelet, with two holes for Styles 52800 P, 52800 R, 52800 S, 52800 T, 52800 U, 52800 V- - - - -	4
161	Collar, for binding holder disc on Styles 52800 P, 52800 R, 52800 S, 52800 U, 52800 V, 52800 W (screw No. 88) - - - - -	9
187 A	Screw, for edge guide on Style 52800 M; also for No. 23306 T- - - - -	5

LIST OF PARTS

Symbol to Order By	The figures in the last column refer only to the plates illustrating the parts and are not to be used in ordering. Prices furnished on application.	Plate No.
188 D	Thumbscrew, for edging spool holder adjust- able cone, on Style 52800 T; also for Nos. 751 A, 752, 21102 B, 21182 AA, 23439, K58937- - - - -	6
243	Cloth Plate End Cover Spring (screw No. 22711)- - - - -	16
258 A	Looper Rocker Cone Nut; also for Nos. 21114 W, 52894 AG - - - - -	7
269	Looper Drive Connecting Rod Nut; also for Nos. 51236 C, 51240 A, 52816- - - - -	7
294	Screw, 15/16 inch long, for head cover; also for No. 52894 K - - - - -	5
357	Screw, for edge guide on Style 52800 T- - - - -	5
402	Stop Screw, for lifter lever link; also for Nos. 21182 AC - - - - -	5
421	Lifter Lever Chain, 38 inches long- - - - -	18
421 C-10	Knee Press Chain, 10 inches long- - - - -	18
422	Lifter Treadle- - - - -	22
423	Lifter Treadle Base - - - - -	17
424	Lifter Treadle Pin (screw No. 22813)- - - - -	17
482	Feed Rocker Shaft Collar (screw No. 98) - - - - -	16
Y500-257	Expansion Reamer, for needle bar bearings, size .257 inch- - - - -	21
Y502-319	Expansion Reamer, for upper presser bar bear- ings, size .319 inch- - - - -	21
Y503-319	Expansion Reamer, for lower presser bar bear- ings, size .319 inch- - - - -	21
Y505-407	Expansion Reamer, for looper rocker and feed rocker shaft bearings, size .407 inch - - - - -	21
Y506-530	Expansion Reamer, for main shaft bearings, size .530 inch- - - - -	21
531	Screw, for presser foot lifter and guide- - - - -	5
604	Screw, for presser foot adjustable guide on Style 52800 T; also for No. 52875 J - - - - -	5
605	Screw, for presser foot yielding section spring on Styles 52800 M, 52800 N, 52800 P, 52800 R, 52800 S, 52800 U, 52800 V, 52800 W	5
650 A-16	Stove Bolt, flat head 5/16 x 2 inches - - - - -	7
650 A-18	Stove Bolt, flat head 5/16 x 2 1/4 inches - - - - -	7
650 A-20	Stove Bolt, flat head 5/16 x 2 1/2 inches - - - - -	7
650 B-26	Stove Bolt, flat head 3/8 x 3 1/4 inches, for table tops- - - - -	7
652-16	Thread Stand Spool Pin Washer; also for No. 21114 U - - - - -	7
652 C-9	Shake Proof Lock Washer, for needle bar eyelet- - - - -	7
660-125	Gasket, for head cover oil drain screw- - - - -	7
660-127	Isolated Insulator Height Adjusting Felt Washer (set of 8) - - - - -	12
660-128	Wood Screw Eye, for knee press assembly - - - - -	12
660-136	Feed Crank Link Oil Tube- - - - -	13

LIST OF PARTS

Symbol to Order By	The figures in the last column refer only to the plates illustrating the parts and are not to be used in ordering. Prices furnished on application.	Plate No.
660-142	Presser Foot Lifter Lever Connecting Rod Cotter Pin - - - - -	12
660-159	Idle Pulleys, set of two, for leading floor treadle lifter chain away from transmitter or line shaft on American Safety Table installations- - - - -	22
660-202	Spreader Rock Shaft Oil Seal Ring- - - - -	9
666-13	Felt Wick, spring pressed, for main shaft bearings - - - - -	9
666-16	Reservoir Glass, for oil drain assembly- - -	22
666-19	Felt Wick, for feed crank link - - - - -	9
666-28	Oil Cup, for needle lever stud (nut No. 12987 A) - - - - -	9
666-29	Felt Wick, for needle lever stud and link pin	13
666-52	Oil Cup, for lower crank chamber cover - - -	13
666-82	Felt Wick, for looper avoid eccentric link and feed lift eccentric link - - - - -	9
666-93	Felt Wick, spring pressed, for feed rocker shaft bearings - - - - -	9
666-94	Felt Wick, spring pressed, for looper rocker shaft bearing - - - - -	9
666-99	Felt Wick, spring pressed, for spreader rock shaft- - - - -	9
668-25	Needle Thread Tension Steel Insert Eyelet; also for No. 52855 A - - - - -	10
668-28	Needle Thread Tension Insert Eyelet Locking Ring; also for No. 52855 A - - - - -	10
698 BB-8	Test Plate, for No. 8 gauge, two needle machines - - - - -	—
698 BB-12	Test Plate, for No. 12 gauge, two needle machines - - - - -	—
698 BB-14	Test Plate, for No. 14 gauge, three needle machines - - - - -	—
698 BB-16	Test Plate, for No. 16 gauge, three needle machines - - - - -	—
699 L-8	Test Pin, left, for No. 8 gauge, two needle machines - - - - -	—
699 L-12	Test Pin, left, for No. 12 gauge, two needle machines - - - - -	—
699 L-14	Test Pin, left, for No. 14 gauge, three needle machines- - - - -	—
699 L-16	Test Pin, left, for No. 16 gauge, three needle machines- - - - -	—
699 R-8	Test Pin, right, for No. 8 gauge, two needle machines- - - - -	—
699 R-12	Test Pin, right, for No. 12 gauge, two needle machines- - - - -	—
699 R-14	Test Pin, right, for No. 14 gauge, three needle machines- - - - -	—
699 R-16	Test Pin, right, for No. 16 gauge, three needle machines- - - - -	—

LIST OF PARTS

Symbol to Order By	The figures in the last column refer only to the plates illustrating the parts and are not to be used in ordering. Prices furnished on application.	Plate No.
719	Set Screw, for needle lever stud; also for No. 51250 B- - - - -	5
751 A	Edging Spool Holder Pin, for Style 52800 T (thumbscrew No. 188 D) - - - - -	12
752	Edging Spool Holder Axle, for Style 52800 T (thumbscrew No. 188 D) - - - - -	23
753	Edging Spool Holder Adjustable Cone, for Style 52800 T (thumbscrew No. 188 D) - - -	18
Y802	Taper Reamer, for needle lever link and feed crank link pins- - - - -	21
907	Differential Feed Regulating Stud Locking Nut; also for No. 23306 Z- - - - -	7
1248	Feed Crank Link Shim, leather- - - - -	11
1286	Feed Crank Link Pin Assembly; one each Nos. 1286 A, 1286 B, 12964 C, 22560 - - - - -	8
1286 A	Needle Lever Link Pin (set screw for upper link pin No. 77, set screw for lower link pin No. 78)- - - - -	8
1286 B	Feed Crank Link Pin Spring (screw No. 22560) - - - - -	8
3026 A	Differential Feed Dog, for Styles 52800 N, 52800 X (screw No. 90) - - - - -	2
3040	Presser Foot Yielding Section Spring, for Style 52800 N- - - - -	4
5003	Edge Guide, for Style 52800 T (pivot screw No. 22735, pivot screw washer No. 12957 E, adjustable section screw No. 357)- - - - -	16
5005 R	Main Feed Dog, for No. 8 gauge Style 52800 T (screw No. 22593)- - - - -	2
5024 B-12	Throat Plate, for No. 12 gauge Style 52800 T (screw No. 87) - - - - -	1
5024 M-8	Throat Plate, for No. 8 gauge Style 52800 T (screw No. 87) - - - - -	1
5026 A	Differential Feed Dog, for Styles 52800 P, 52800 R, 52800 S, 52800 U, 52800 V, (screw No. 90) - - - - -	2
5041	Presser Foot Yielding Section, right, for Style 52800 M- - - - -	4
5105 B	Main Feed Dog, for No. 12 gauge Style 52800 T (screw No. 22593)- - - - -	2
5126	Differential Feed Dog, for No. 12 gauge Style 52800 T (screw No. 90) - - - - -	2
5126 B	Differential Feed Dog, for Style 52800 M (screw No. 90) - - - - -	2
5127 C	Presser Foot, for Style 52800 M (clamp screw No. 91, yielding section, right, No. 5041, yielding section, left No. 5141, yielding section spring No. 5140, yielding section screw No. 605) - - - - -	3

LIST OF PARTS

Symbol to Order By	The figures in the last column refer only to the plates illustrating the parts and are not to be used in ordering. Prices furnished on application.	Plate No.
5127 H	Presser Foot, for Style 52800 N (clamp screw No. 91, yielding section, left, No. 5141 L, yielding section, right, No. 5141 R, yielding section spring No. 3040, yielding section spring screw No. 605) - -	3
5140	Presser Foot Yielding Section Spring, for Style 52800 M (screw No. 605) - - - - -	4
5141	Presser Foot Yielding Section, left, for Style 52800 M - - - - -	4
5141 L	Presser Foot Yielding Section, left, for Style 52800 N - - - - -	4
5141 R	Presser Foot Yielding Section, right, for Style 52800 N - - - - -	4
5650	Main Feed Dog Holder, for Style 52800 W (screw No. 22519 C) - - - - -	2
6042 A	Looper Connecting Rod Ball Joint Oil Tube Washer; also for Nos. 52849 B, 52852 A - -	7
7947	Feed Crank Link Nut - - - - -	7
8372	Intermittent Feed Index Stop, for Style 52800 R (screw No. 25 CC) - - - - -	11
8372 A	Intermittent Differential Feed Index Stop Washer - - - - -	7
9271	Knee Press Shaft Collar (screw No. 98) - - -	16
9937	Presser Foot Lifter Lever Connecting Link Stud Nut - - - - -	7
10303 A	Edge Guide, for Style 52800 M (screw No. 25 C) - - - - -	16
11534	Presser Foot Yielding Section Spring, for Styles 52800 P, 52800 R, 52800 S, 52800 U, 52800 V, 52800 W (screw No. 605) - - - - -	4
11663	Intermittent Strip Tension Operating Lever Spring - - - - -	8
12538	Looper Rocker Ball Stud Nut; also for No. 22852 - - - - -	7
12934 A	Nut, for front spreader connecting rod ball stud; also for No. 52835 D - - - - -	7
12957 E	Edge Guide Spring Washer, for Style 52800 T; also for No. 23306 AA - - - - -	7
12964 C	Feed Crank Link Pin Ball - - - - -	8
12987 A	Nut, for needle lever stud oil cup - - - - -	7
13105 B	Main Feed Dog, for No. 10 gauge Style 52800 T (screw No. 22593) - - - - -	2
13120 F-8	Presser Foot Assembly, for No. 8 gauge Styles 52800 P, 52800 R, 52800 S; one each Nos. 13130 F-8, 73 A, 91, 605, 11534, 13130 A, 13130 B, 22799 B - - - - -	3
13124 B-10	Throat Plate, for No. 10 gauge Style 52800 T (screw No. 87) - - - - -	1
13130 A	Presser Foot Yielding Section, for Styles 52800 P, 52800 R, 52800 S, 52820 W, (screw No. 73 A) - - - - -	4

LIST OF PARTS

Symbol to Order By	The figures in the last column refer only to the plates illustrating the parts and are not to be used in ordering. Prices furnished on application.	Plate No.
13130 B	Presser Foot Shank, for Styles 52800 P, 52800 R, 52800 S, 52800 U, 52800 V, 52800 W (clamp screw No. 91)- - - - -	4
13130 F-8	Presser Foot Bottom, for No. 8 gauge Styles 52800 P, 52800 R, 52800 S (hinge screw No. 22799 B)- - - - -	3
13153	Main Feed Dog Holder, for Styles 52800 M, 52800 N, 52800 P, 52800 R, 52800 S, 52800 T, 52800 U, 52800 V, 52800 X (screw No. 22519 C)- - - - -	2
15037 A	Nut, for rear spreader connecting rod ball stud- - - - -	7
15430 C	Needle Lever Connecting Rod Nut, left thread- - - - -	7
15430 D	Needle Lever Connecting Rod Nut, right thread; also for No. 52816- - - - -	7
15438 B	Supplementary Tension Disc, for spreader thread- - - - -	7
15438 C	Supplementary Tension Spring- - - - -	8
15438 D	Supplementary Tension Stud- - - - -	6
15447 A	Tape Clipper Lower Knife Adjusting Screw- -	8
15465 F	Looper Rocker Cone (screw No. 88, nut No. 258 A)- - - - -	9
15480 C	Presser Foot Bottom Spring, for Style 52800 T - - - - -	4
21101 H-4	Thread Stand Assembly, Style "H", with four disc type spool seats; one each Nos. 21114 D-4, 21104 B-24, 21104 H, 21114 A, 21114 H-4, 21114 S-4, 21114 T, 22810; two No. 21114 U; four each Nos. 21104 V, 21114, 21114 W; five No. 652-16; eight No. 258 A	24
21101 H-6	Thread Stand Assembly, Style "H", with six disc type spool seats; one each Nos. 21114 D-6, 21104 B-24, 21104 H, 21114 A, 21114 H-6, 21114 S-6, 21114 T, 22810; two No. 21114 U; six each Nos. 21104 V, 21114, 21114 W; seven No. 652-16; twelve No. 258A	24
21102 B	Edging Spool Holder Supporting Rod, 18 inches long, .250 inch diameter, for Style 52800 T (thumbscrew No. 188 D)- - - - -	23
21104 B-24	Thread Stand Rod, 24 inches long (set screw No. 22591)- - - - -	22
21104 H	Thread Stand Lead-in Eyelet Support Socket Nut - - - - -	7
21104 V	Thread Stand Felt Pad, 5 1/4 inch diameter-	23
21114	Thread Stand Spool Seat Disc- - - - -	24
21114 A	Thread Stand Base (set screw No. 22591) - -	23
21114 D-4	Thread Stand Seat, for 4 cones (screw No. 22591 G)- - - - -	24
21114 D-6	Thread Stand Seat, for 6 cones (screw No. - 22591 G)- - - - -	24

LIST OF PARTS

Symbol to Order By	The figures in the last column refer only to the plates illustrating the parts and are not to be used in ordering. Prices furnished on application.	Plate No.
21114 H-4	Thread Stand Eyelet Support, for four cones (screw No. 22591 A, insert eyelet No. 21114 L, eyelet locking ring No. 21114 M)	24
21114 H-6	Thread Stand Eyelet Support, for six cones (screw No. 22591 A, insert eyelet No. 21114 L, eyelet locking ring No. 21114 M)	24
21114 L	Thread Stand Eyelet Support Steel Insert Eyelet- - - - -	10
21114 M	Thread Stand Eyelet Support Insert Eyelet Locking Ring- - - - -	10
21114 S-4	Thread Stand Lead-in Eyelet Support, for 4 cones, (insert eyelet No. 21114 L, eyelet locking ring No. 21114 M)	24
21114 S-6	Thread Stand Lead-in Eyelet Support, for 6 cones (insert eyelet No. 21114 L, eyelet locking ring No. 21114 M)	24
21114 T	Thread Stand Lead-in Eyelet Support Socket Ball (set screw No. 22591)- - - - -	17
21114 U	Thread Stand Lead-in Eyelet Ball Socket, half section (washer No. 652-16, nut No. 21104 H)	17
21114 W	Thread Stand Spool Pin (washer No. 652-16, lock nut No. 258 A) - - - - -	24
21145	Cone, wood, for thread stand- - - - -	18
21169 D	Split Tube Border Holder Assembly, for Styles 52800 P, 52800 R, 52800 S, 52800 U, 52800 V, 52800 W; one each Nos. 88, 161, 21169 E, 21169 F (specify component parts in ordering)- - - - -	23
21169 E	Split Tube Border Holder Disc - - - - -	23
21169 F	Split Tube Border Holder Base - - - - -	23
21182 AA	Intermittent Strip Tension Assembly, for Style 52800 P; one each Nos. 110-2, 188 D, 11663, 21182 AB, 21182 AC, 21182 AD, 21182 AE, 21182 AF, 22504 B, 22561, 22760, 22845 E, 23439 C; two each No. 402, 21185 (attaching screws No. 22548)- - - - -	20
	NOTE: This assembly applies a constant ten- sion on the strip which can be released by operating treadle.	
21182 AB	Intermittent Strip Tension Base (screw No. 22548)- - - - -	23
21182 AC	Intermittent Strip Tension Operating Lever (pivot stud No. 22504 B, stop screw No. 402)	15
21182 AD	Intermittent Strip Tension Operating Arm (pivot screw No. 22760) - - - - -	15
21182 AE	Intermittent Strip Tension Adjustable Strip Guide (screw No. 22561) - - - - -	15
21182 AF	Intermittent Strip Tension Plate (locating screw No. 22845 E)- - - - -	15
21185	Intermittent Strip Tension Spring Nut - - - -	7

LIST OF PARTS

Symbol to Order By	The figures in the last column refer only to the plates illustrating the parts and are not to be used in ordering. Prices furnished on application.	Plate No.
21198 B	Split Tube Border Measuring Gauge Brace, for Styles 52800 P, 52800 R, (screw No. 94) - -	20
21198 E	Split Tube Border Measuring Gauge Assembly, maximum measuring length 9 1/2 inches, for Styles 52800 P, 52800 R; one each Nos. 94, 21198 B, 21198 F, 21198 G, 21198 H; two each Nos. 21198 J, 22756 (screw No. 25 S, washer No. 21657 E, brace screw No. 93) - -	19
21198 F	Split Tube Border Measuring Gauge Base - - -	19
21198 G	Split Tube Border Measuring Gauge Slide, front (thumbscrew No. 22756, nut No. 21198 J) - - - - -	16
21198 H	Split Tube Border Measuring Gauge Slide, rear (thumbscrew No. 22756, nut No. 21198 J) - - - - -	16
21198 J	Split Tube Border Measuring Gauge Slide Lock Nut (thumbscrew No. 22756) - - - - -	12
21201	Screw Driver, 9/64 inch round blade, length overall 7 5/8 inches - - - - -	21
21202	Screw Driver, 7/32 inch round blade, length overall 11 1/4 inches - - - - -	21
21203	Screw Driver, 13/64 inch round blade, length overall 15 1/2 inches - - - - -	21
21204	Screw Driver, 9/32 inch round blade, length overall 15 inches - - - - -	21
21205 A	Screw Driver, 3/8 inch round blade, length overall 14 inches - - - - -	21
21207	Screw Driver, 7/64 inch round blade, length overall 2 1/2 inches - - - - -	17
21208	Screw Driver Set, three detachable blades - -	22
21210	Looper Collar, .040 inch thick - - - - -	7
21210 A	Looper Collar, .020 inch thick - - - - -	7
21211	Looper Collar, .054 inch thick - - - - -	7
21215 C	Edging Spool Holder Assembly, for Style 52800 T; one each Nos. 752, 753, 21102 B, two each Nos. 751 A, 21216, 21217, 21217 A, 22620 H-20; 22728; five No. 188 D - - - - -	23
	Specify component parts in ordering.	
21216	Edging Spool Holder Upright Rod, for Style 52800 T (set screw No. 22620 H-20) - - - - -	20
21217	Edging Spool Holder Support Base, for Style 52800 T - - - - -	22
21217 A	Edging Spool Holder Pin Support, for Style 52800 T (thumbscrew No. 22728) - - - - -	12
21225-3/16	Looper Adjusting Gauge, 3/16 inch measure- ment - - - - -	8
21225-7/32	Looper Adjusting Gauge, 7/32 inch measure- ment - - - - -	8
21225-1/4	Looper Adjusting Gauge, 1/4 inch measurement	8
21227 C-8	Spreader Gauge, for adjusting spreader on No. 8 gauge, two needle machines - - - - -	8

LIST OF PARTS

Symbol to Order By	The figures in the last column refer only to the plates illustrating the parts and are not to be used in ordering. Prices furnished on application.	Plate No.
21227 C-12	Spreader Gauge, for adjusting spreader on No. 12 gauge, two needle machines- - - -	8
21227 C-14	Spreader Gauge, for adjusting spreader on No. 14 gauge, three needle machines- - -	8
21227 C-16	Spreader Gauge, for adjusting spreader on No. 16 gauge, three needle machines- - -	8
21227 R	Gauge, for synchronizing looper and needle motions on machines equipped with throat plates 2 1/4 inches long; component parts are shipped in leather case- - - - -	18
21227 V	Gauge, for setting height of spreader and presser foot - - - - -	8
21231 D	Thread Meter, for recording the consumption of thread in 1/10 yards as it passes into the sewing machine - - - - -	—
21236	Belt Plier, for 3/8 inch and smaller round belting- - - - -	21
21260	Emery Cord, 3/64 inch diameter, grade No. 120, fifty yard spool- - - - -	—
21260 A	Emery Cord, 3/64 inch diameter, grade No. 150, fifty yard spool- - - - -	—
21260 B	Emery Cord, 1/32 inch diameter, grade No. 180, fifty yard spool- - - - -	—
21260 C	Emery Cord, .025 inch diameter, grade No. 200, fifty yard spool- - - - -	—
21260 D	Emery Tape, 3/32 inch wide, grade No. 180, fifty yard spool - - - - -	—
21260 E	Emery Cord, .018 inch diameter, grade No. 200, fifty yard spool- - - - -	—
21261	Leather Belt, flat, 1 inch wide, 63 inches long, includes belt fastener No. 21350 -	—
21262	Leather Belt, round, 9/32 inch diameter, 44 inches long, includes wire belt hook No. 21351- - - - -	—
21262 H-340	"V" Belt, No. 2 size, 34 inches outside circumference- - - - -	22
21262 H-350	"V" Belt, 35 inches outside circumference -	22
21262 H-370	"V" Belt, 37 inches outside circumference -	22
21262 H-380	"V" Belt, 38 inches outside circumference -	22
21350	Belt Fastener, malleable iron, for 1 inch flat belt- - - - -	12
21351	Belt Hook, wire, for 9/32 inch round belt-	12
B21375 AH	Pulley Guard, machine mounting (screw No.93)	22
21388	Wrench, single end, 3/8 inch opening - - -	17
21388 N	Wrench, double end, 3/16 and 5/16 inch openings - - - - -	17
21388 R	Wrench, double end, 3/8 and 1/2 inch openings - - - - -	17
21388 W	Wrench, double end, curved, 9/32 inch opening - - - - -	17
21388 X	Wrench, for main shaft bearing housing - -	23

LIST OF PARTS

Symbol to Order By	The figures in the last column refer only to the plates illustrating the parts and are not to be used in ordering. Prices furnished on application.	Plate No.
21388 Z	Wrench, for setting needle lever stud with respect to oil groove. Stud is set correctly when the pin hole nearest the periphery is up and a line drawn between the two pin holes is 45 degrees to the right of the vertical- - - - -	17
21388 AE	Socket Wrench Assembly, for 9/32 inch and 3/8 inch hexagonal nuts, for looper lever ball stud locking stud - - - - -	18
21394	Utility Grinder, including emery wheel, 5 inches diameter, 1/4 inch face, round belt drive, recommended speed 3000 R.P.M. - - - -	—
21394 G	Emery Wheel, 5 inches diameter, 1/4 inch face, 3/8 inch hole, grade "M" emery 60 - - - - -	—
21394 H	Emery Wheel, 5 inches diameter, 1/2 inch face, 3/8 inch hole, grade "M" emery 60 - - - - -	—
21394 K	Utility Grinder, including emery wheel, 5 inches diameter, 1/2 inch face, round belt drive, recommended speed 3000 R.P.M.- - - -	—
21657-3	Tension Release Disc Separator, for Styles 52800 P, 52800 R, 52800 S, 52800 T, 52800 U, 52800 V- - - - -	15
21657-4	Tension Release Disc Separator, for Styles 52800 M, 52800 N, 52800 W, 52800 X- - - - -	15
21657 E	Cast-off Plate Support Washer; also for Nos. 21198 E, K57904 - - - - -	7
21657 W	Tension Release Lever Shaft - - - - -	14
21657 X	Tension Release Lever Shaft Bushing - - - - -	14
21657 Y	Tension Release Lever Shaft Connection (screw No. 22596)- - - - -	12
21661	Knee Press Shaft- - - - -	22
21662	Knee Press Shaft Hanger - - - - -	20
21664	Knee Press Plate (set screw No. 69 FD)- - - -	22
21665	Knee Press Plate Rod Connection (screw No. 69 FD)- - - - -	20
21677	Knee Press Bell Crank Arm - - - - -	22
21679	Knee Press Pitman Lever - - - - -	22
21691	Knee Press Assembly, for operating intermittent strip tension on Style 52800 P; one each Nos. 421 C-10, 660-128, 21661, 21662, 21664, 21677, 21679, 28505; two each Nos. 9271, 21665. (specify component parts in ordering.)- - - - -	22
21698-2	Vibration Insulator, two inches long, for tables- - - - -	18
21698-4	Vibration Insulator, four inches long - - - -	18
21698-5	Vibration Insulator, five inches long - - - -	18
21698-6	Vibration Insulator, six inches long- - - - -	18
	NOTE: Special lengths will be furnished on request. Part of the table leg is shown in the illustration for clarity.	

LIST OF PARTS

Symbol to Order By	The figures in the last column refer only to the plates illustrating the parts and are not to be used in ordering. Prices furnished on application.	Plate No.
22504 B	Pivot Stud, for intermittent strip tension operating lever- - - - -	7
22504 C	Pivot Screw, for edging guide and tension assembly mounting bracket on Style 52800 T -	6
22513	Screw, for presser bar connection guide plate; also for No. 52894 M - - - - -	5
22516	Screw, for feed rocker segment slot plate, on Style 52800 R; also upper screw for 52836 G-	5
22517 C	Screw, 5/16 inch long, for supplementary ten- sion stud- - - - -	7
22519 C	Screw, for feed rocker arm; also for Nos. 5650, 13153- - - - -	6
22521	Screw, plus size, for cloth plate (tap No. V118)- - - - -	6
22524	Screw, countersunk head, for oil reservoir top cover- - - - -	6
22528	Screw, for cast-off plate support; also for No. 55243 A- - - - -	5
22537	Screw, for presser foot lifter lever - - - - -	5
22539 A	Plug Screw, .510 inch diameter, for oil holes in bed - - - - -	5
22539 D	Plug Screw, for spreader rock shaft hole in bed- - - - -	5
22548	Screw, for crank chamber lower cover; also for Nos. 21182 AA, 21182 AB, 23432, 23439 D - -	5
22557 B	Screw, for presser foot lifter lever bell crank- - - - -	6
22559 A	Bearing Screw, lower, for looper drive connection - - - - -	6
22559 B	Bearing Screw, upper, for looper drive connection - - - - -	6
22560	Screw, for feed crank link pin; also for No. 52842- - - - -	5
22560 B	Screw, headless, for main feed bar; also for No. 52894 AF - - - - -	5
22561	Screw, for intermittent strip tension adjust- able strip guide; also for Nos. 23133 L, 23133 M, 52830 B - - - - -	5
22562	Screw, for folder swinging arm latch; also for No. 52888 B- - - - -	5
22565 C	Screw, for differential feed bar guide - - - - -	5
22567	Screw, for folder support bracket on Styles 52800 P, 52800 R, 52800 S, 52800 U, 52800 V, 52800 W- - - - -	6
22568	Screw, for edging guide on Style 52800 T - - - -	6
22569	Screw, for feed crank link; also for No. 52882 N- - - - -	5
22569 B	Screw, for main shaft bushing housing- - - - -	5
22571 A	Plug Screw, .368 inch diameter for oil holes in bed - - - - -	5
22572 A	Screw, 35/64 inch long, for head cover - - - -	5

LIST OF PARTS

Symbol to Order By	The figures in the last column refer only to the plates illustrating the parts and are not to be used in ordering. Prices furnished on application.	Plate No.
22574	Screw, for throat plate support - - - - -	6
22580	Set Screw, for shielded disc take-up- - - -	5
22585 A	Screw, fillister head, for oil reservoir top cover - - - - -	5
22587 F	Screw, for spreader eccentric bearing - - -	6
22591	Set Screw, for thread stand base; also for Nos. 21104 B-24, 21114 T- - - - -	5
22591 A	Set Screw, for thread stand eyelet support-	5
22591 G	Set Screw, for thread stand seat- - - - -	6
22593	Screw, for main feed dogs; also for No. 39237 D - - - - -	5
22596	Clamp screw, for tension release lever shaft connection- - - - -	5
22597	Spot Screw, for pulley- - - - -	5
22597 A	Set Screw, for pulley - - - - -	5
22597 B	Spot Screw, for looper drive lever- - - - -	5
22620 H-20	Screw, headless, cup point, 1/4 inch diam- eter, 20 threads per inch, 5/16 long, for edging spool holder upright rod on Style 52800 T - - - - -	5
22703	Thumbscrew, for regulating edging tension on Style 52800 T - - - - -	6
22706 A	Plug Screw, for left spreader rock shaft lug	5
22711	Screw, for cloth plate end cover spring - -	5
22728	Thumbscrew, for edging spool holder pin support on Style 52800 T- - - - -	6
22733 B	Plug Screw, for head cover- - - - -	6
22735	Pivot Screw, for edge guide on Style 52800 T	6
22742	Pivot Screw, upper, for presser foot lifter lever connecting link - - - - -	6
22747	Screw, for adjusting height of main feed dogs; also for No. 41255 B- - - - -	5
22756	Thumbscrew, for split tube border measuring gauge slide on Styles 52800 P, 52800 R- -	6
22758 B	Pivot Screw, lower, for presser foot lifter lever connecting link; also for No. 51283 F - - - - -	6
22760	Pivot Screw, for intermittent strip tension operating arm - - - - -	6
22768	Screw, for needle bar and needle lever thread eyelets; also for No. 51236 B- - -	5
22781	Lock Screw, for main feed dog height adjust- ing screw - - - - -	6
22795	Stitch Regulating Screw - - - - -	6
22799 B	Hinge Screw, length overall 19/32 inch, .088 diameter, for presser foot bottom on Styles 52800 P, 52800 R, 52800 S, 52800 U, 52800 V, 52800 W- - - - -	6
22799 E	Hinge Screw, length overall 41/64 inch, .088 diameter, for presser foot bottom on Style 52800 X - - - - -	6

LIST OF PARTS

Symbol to Order By	The figures in the last column refer only to the plates illustrating the parts and are not to be used in ordering. Prices furnished on application.	Plate No.
22801	Stop Screw, for stitch regulating screw--	5
22810	Clamp Screw, for thread stand lead-in eyelet ball socket - - - - -	6
22813	Screw, headless, for lifter treadle pin--	5
22829	Locking Screw, for looper rocker cone nut; also for No. 52875 H - - - - -	5
22837	Thumbscrew, for edging guide and tension assembly on Style 52800 T- - - - -	6
22839 F	Screw, fillister head, for cloth plates--	6
22845	Screw, for intermittent strip tension plate	6
22848	Screw, for end cover hinge; also for Nos. 51758, 52835 N, 52882 L, 52885 H - - - -	6
22852	Stop Screw, for tape clipper operating lever (lock nut No. 12538) - - - - -	6
22852 A	Clamp Screw, for looper drive lever rocker	6
22868 A	Screw, for differential feed fork block on Style 52800 R- - - - -	6
22872	Screw, for spreader thread take-up eyelet-	6
22882 A	Clamp Screw, for looper drive lever--	6
22889 A	Adapter Screw, for frame needle thread eyelet - - - - -	7
22894 C	Set Screw, for looper drive eccentrics --	5
22894 D	Spot Screw, for feed lift and looper avoid eccentrics; also for No. 29105 R - - - -	5
23133 L	Edge Guide, 3/64 inch capacity, for body of garment on Style 52800 S (screw No. 22561)	16
23133 M	Edge Guide, 3/32 capacity, for body of gar- ment on Styles 52800 U, 52800 V, 52800 W (screw No. 22561)- - - - -	16
23195	Edge Guide, for Style 52800 N(screw No.187A)	12
23279 D	Folder Threader- - - - -	18
23306 Q	Edging Guide, for Style 52800 T(screw No. 22568) - - - - -	16
23306 T	Edging Guide, for Style 52800 T (screw No. 187 A) - - - - -	16
23306 Z	Edging Guide and Tension Assembly, for Style 52800 T (attaching screw No. 94, adjustable guide No. 23306 T, adjustable guide screw No. 187 A, tension regulating screw No. 22703, tension regulating screw lock nut No. 907)- - - - -	20
23306 AA	Edging Guide and Tension Assembly Mounting Bracket, for Style 52800 T (mounting stud No. 52882 V, thumbscrew No. 22837, spring washer No.12957 E, pivot screw No.22504C)	20
23406 L-1/2	Folder, 1/32 inch strip capacity, for att- aching split tube borders on Styles 52800 P, 52800 R, 1/2 inch finish, strip cut 1 inch wide - - - - -	19

LIST OF PARTS

Symbol to Order By	The figures in the last column refer only to the plates illustrating the parts and are not to be used in ordering. Prices furnished on application.	Plate No.
23406 L-5/8	Folder, for 5/8 inch finish, strip cut 1 1/4 inches wide- - - - -	19
23406 L-3/4	Folder, for 3/4 inch finish, strip cut 1 1/2 inches wide- - - - -	19
23406 M-1/2	Folder, 3/64 inch strip capacity, for attaching split tube borders on Style 52800 S, 1/2 inch finish, strip cut 1 inch wide- - - - -	19
23406 M-5/8	Folder, for 5/8 inch finish, strip cut 1 1/4 inches wide- - - - -	19
23406 M-3/4	Folder, for 3/4 inch finish, strip cut 1 1/2 inches wide- - - - -	19
23406 M-7/8	Folder, for 7/8 inch finish, strip cut 1 3/4 inches wide- - - - -	19
23406 M-1	Folder, for 1 inch finish, strip cut 2 inches wide- - - - -	19
23406 N-3/4	Folder, 5/64 inch strip capacity, for attaching collarettes on Styles 52800 U, 52800 W, 3/4 inch finish, strip cut 1 1/2 inches wide- - - - -	19
23406 N-7/8	Folder, 7/8 inch finish, strip cut 1 3/4 inches wide- - - - -	19
23406 N-1	Folder, 1 inch finish, strip cut 2 inches wide - - - - -	19
23406 N-1 1/4	Folder, 1 1/4 inch finish, strip cut 2 1/2 inches wide- - - - -	19
23425 V	Folder Attaching Screw No. 25 CC Washer Plate, for folder support on Style Styles 52800 P, 52800 R, 52800 S, 52800 U, 52800 V, 52800 W- - - - -	16
23432	Folder Clamp, for Styles 52800 P, 52800 R, 52800 U, 52800 V, 52800 W (attaching screw No. 22548) - - - - -	16
23439 C	Intermittent Strip Tension Adjustable Pin, for Style 52800 P (thumbscrew No. 188 D) - - - - -	20
23439 D	Pin Tension Assembly, for Styles 52800 R, 52800 S, 52800 U, 52800 V, 52800 W, (attaching screw No. 22548)- - - - -	23
23439 E	Pin Tension Adjustable Pin, for Styles 52800 R, 52800 S, 52800 U, 52800 V, 52800 W (thumbscrew No. 188 D) - - - - -	23
28505	Knee-Press Pitman Lever Spring, for Style 52800 P- - - - -	16
28604	Transmitter Lubricant, No. 3 Arctic Cup grease, 5 lb. package- - - - -	—
28604 G	Straight Mineral Oil, SAE-10 "W", put up in 10 fluid ounces to can, which is the capacity of machine- - - - -	—
28606-1/2	Powdered Oil Stone, 1/2 lb. package- - -	—
28606-1	Powdered Oil Stone, 1 lb. package- - -	—

LIST OF PARTS

Symbol to Order By	The figures in the last column refer only to the plates illustrating the parts and are not to be used in ordering. Prices furnished on application.	Plate No.
29066 P	Needle Lever Connecting Rod Upper Bearing Assembly; one each Nos. 52816 G, 55243 A, lapped together- - - - -	15
*29105 R	Looper Drive Eccentric Assembly, includes eccentric No. 52743 (set screw No. 22894 C, spot screw No. 22894 D, bearing screw, upper, No. 22559 B, bearing screw, lower No. 22559 A) - - - - -	15
*29126 BH	Spreader Eccentric Assembly; includes eccentric No. 52851 B (set screw No. 95, bearing screw No. 22587 F) - - - - -	15
29192	Looper Rocker Assembly, one each Nos. 51213, 15465 F, 51745 lapped together; also one each Nos. 258 A, 22829 - - - - -	13
29264 S-16	Needle Bar Assembly, for No. 16 gauge Styles 52800 M, 52800 N, 52800 W, 52800 X, one each Nos. 52817-16, 28 C, 52818-8- - - -	14
29348 N	Needle Lever Assembly; one each Nos. 51215 H, 54, 77, 78, 35759, 51250; two each Nos. 88 A, 22528, 51054 - - - - -	19
29402	Lifter Treadle Assembly; one each Nos. 422, 423, 424, 22813- - - - -	22
*29476 AY	Crankshaft Assembly, includes crankshaft No. 51222 A (bearing screw No. 75 A) - - - - -	19
29486 A	Tape Clipper Assembly, treadle operated; one each Nos. 12538, 15447 A, 22852, 51283 G, 52875, 52875 A, 52875 B, 52875 C, 52875 D, 52875 E, 52875 F, 52875 G, 52875 H, 52875 J, two each Nos. 93, 604, 22528, 22596, 22829 (attaching screw No. 136) - - -	—
35582 B	Supplementary Tension Disc Thread Guide, for spreader thread- - - - -	12
35731 A	Presser Bar Connection Guide Plate (screw No. 22513) - - - - -	11
35741 A	Looper Connecting Rod (nut, right thread, No. 18, nut, left thread No. 269)- - - - -	14
35759	Needle Bar Connection- - - - -	11
39132 V	Cloth Plate End Cover Latch Pin- - - - -	11
39236	Differential Feed Regulating Screw Sliding Block, for Style 52800 R - - - - -	12
39236 A	Differential Feed Regulating Stud Washer - -	7
39236 B	Differential Feed Regulating Stud, for Styles 52800 M, 52800 N, 52800 P, 52800 S, 52800 T, 52800 U, 52800 V, 52800 W, 52800 X (locking nut No. 907, adjusting nut No. 52834 N) - - - - -	8
39236 C	Differential Feed Regulating Stud Stop; for Styles 52800 M, 52800 N, 52800 P, 52800 S, 52800 T, 52800 U, 52800 V, 52800 W, 52800 X- - - - -	8

LIST OF PARTS

Symbol to Order By	The figures in the last column refer only to the plates illustrating the parts and are not to be used in ordering. Prices furnished on application.	Plate No.
39236 V	Differential Feed Control Rear Lever Link Bushing, for Styles 52800 M, 52800 N, 52800 P, 52800 S, 52800 T, 52800 U, 52800 V, 52800 W, 52800 X - - - - -	7
39237	Differential Feed Bar Guide (screw No. 22565C)	12
39237 D	Differential Feed Bar Guide Plate (screw No. 22593)- - - - -	12
39237 G	Differential Feed Bar Bushing - - - - -	9
41071 G	Nut, for upper spreader eccentric connecting rod bearing oil drip plate- - - - -	7
41076 D	Needle Bar Thread Eyelet, for spreader thread (screw No. 73 A)- - - - -	4
41255 B	Spreader Rock Shaft Connecting Rod Ball Joint Stud Fork (screw No. 22747) - - - - -	11
41394 A	Head Cover Plug Screw Gasket- - - - -	7
43266	Spreader Thread Tension Post Nut; also upper needle thread tension post nut for Styles 52800 M, 52800 N, 52800 W, 52800 X- - - - -	7
43281 K	Folder Swinging Arm Spring (screw No. 90) - -	8
43281 L	Folder Swinging Arm Latch (screw No. 22562) -	8
43294 A	Oil Drain Support - - - - -	21
43294 D	Oil Drain Pipe, 3 inches long - - - - -	18
51054	Needle Lever Link Pin, includes felt wicking-	8
51145	Feed Lift and Loper Avoid Eccentric Link (oil wick No. 666-82) - - - - -	10
51147	Main Shaft Collar (screw No. 95)- - - - -	9
51213	Looper Rocker - - - - -	13
51215 H	Needle Lever, steel - - - - -	19
51216	Needle Lever Connecting Rod Tube (nut, left thread No. 15430 C, nut, right thread, No. 15430 D)- - - - -	14
51222	Main Shaft, left section- - - - -	20
51235 G	Feed Rocker Arm Clamp Screw Washer- - - - -	7
51236	Feed Crank Link (oil wick No. 666-19, shim No. 1248, screw No. 22569, nut No. 7947)- - - -	10
51236 A	Feed Lift and Loper Avoid Eccentric Link Pin (screw No. 77)- - - - -	8
51236 B	Stitch Regulating Stud Cap (screw No. 22768)-	12
51236 C	Feed Crank Stud (nut No. 269) - - - - -	12
51240 A	Spreader Connecting Rod (nut, right thread, No. 18, nut, left thread No. 269) - - - - -	8
51242 L	Looper Drive Lever Rocker Thrust Washer, 1/16 inch thick - - - - -	7
51242 M	Looper Drive Lever Clamp Screw Washer; also for No. 52742 D - - - - -	7
51242 P	Looper Drive Lever Shaft- - - - -	14
51242 Q	Looper Drive Lever Shaft Bushing, front - - -	9
51242 R	Looper Drive Lever Shaft Bushing, middle- - -	9
51242 S	Looper Drive Lever Shaft Bushing, rear- - -	9
51243 C	Looper Drive Lever Ball Stud Fork; also for No. 55243 A (screw No. 97)- - - - -	11

LIST OF PARTS

Symbol to Order By	The figures in the last column refer only to the plates illustrating the parts and are not to be used in ordering. Prices furnished on application.	Plate No.
51244	Looper Rocker Frame (spot screw No. 96, set screw No. 98) - - - - -	13
51244 A	Looper Rock Shaft - - - - -	14
51244 B	Looper Rock Shaft Arm (screw No. 93)- - - -	10
51246	Looper Rocker Stud Nut- - - - -	7
51250	Needle Lever Stud (screw No. 719) - - - - -	16
51250 B	Needle Lever Thrust Collar (screw No. 719)-	9
51254	Needle Bar Bushing, upper - - - - -	9
51254 A	Needle Bar Bushing, lower - - - - -	9
51283 F	Presser Foot Lifter Lever Link (pivot screw No. 22758 B, stud No. 402)- - - - -	11
51283 G	Tape Clipper Operating Lever Spring - - - -	8
51292	Tension Post, for spreader thread - - - - -	10
51292 A	Tension Post Ferrule- - - - -	10
51292 C	Tension Regulating Nut- - - - -	7
51292 D	Tension Thread Eyelet (insert eyelet No. 668-25, locking ring No. 668-28)- - - - -	4
51292 F-1	Tension Spring, .016 inch diameter wire, for looper threads- - - - -	8
51292 F-2	Tension Spring, .022 inch diameter wire, for spreader thread - - - - -	8
51292 F-4	Tension Spring, .026 inch diameter wire, for needle thread - - - - -	8
51292 F-5	Tension Spring, .031 inch diameter wire, for needle thread - - - - -	8
51292 F-8	Tension Spring, .037 inch diameter wire, for needle thread - - - - -	8
51292 G	Tension Post, for needle threads- - - - -	10
51294 A	Oil Drain Clamp Spring- - - - -	22
51295	Isolated Insulator, for "II" installation -	12
51296	Machine Base Dowel Pin, front - - - - -	11
51296 A	Machine Base Dowel Pin, rear- - - - -	11
51321 C	Pulley, working diameter 2 1/2 inches, for round belt (spot screw No. 22597, set screw No. 22597 A)- - - - -	16
51321 D	Pulley, working diameter 2 1/2 inches, for No. 2 "V" belt (spot screw No. 22597, set screw No. 22597 A)- - - - -	16
51458	Needle Lever Thread Eyelet, for Styles 52800 P, 52800 R, 52800 S, 52800 T, 52800 U, 52800 V (screw No. 22768)- - - -	4
51458 A	Needle Bar Thread Eyelet, for Styles 52800 P, 52800 R, 52800 S, 52800 T, 52800 U, 52800 V (screw No. 22768, lock washer No. 652 C-9) - - - - -	4
51491 C	Lead-in Thread Eyelet - - - - -	4
51741 E	Looper Connecting Rod Ball Stud Washer- - -	7
51745	Looper Rocker Cone Stud (nut No. 51246) - -	11
51758	Frame Thread Eyelet, intermediate (attach- ing screw No. 22848, adapter screw No. 22889 A, washer No. 20) - - - - -	4

LIST OF PARTS

Symbol to Order By	The figures in the last column refer only to the plates illustrating the parts and are not to be used in ordering. Prices furnished on application.	Plate No.
51958	Needle Lever Thread Eyelet, for Styles 52800 M, 52800 N, 52800 W, 52800 X (screw No. 22768) - - - - -	4
51958 A	Needle Bar Thread Eyelet, for Styles 52800 M, 52800 N, 52800 W, 52800 X (screw No. 22768) - - - - -	4
51959 B	Looper Thread Nipper Disc - - - - -	12
51959 C	Looper Thread Nipper Spring - - - - -	8
51959 D	Looper Thread Nipper Stud Nut - - - - -	7
51959 E	Looper Thread Nipper Stud Spacing Collar- -	7
52710 F	Looper Needle Guard, for No. 14 gauge Style 52800 K (screw No. 73 A)- - - - -	4
52717 B-12	Needle Bar, marked "BH-12" for No. 12 gauge Styles 52800 T, 52800 U, 52800 V (set screw No. 88 A) - - - - -	14
52730	Presser Foot Shank, for Style 52800 T (clamp screw No. 91)- - - - -	4
52730 A	Presser Foot Adjustable Guide, for Style 52800 T (screw No. 604) - - - - -	3
52730 C	Presser Foot Adjustable Guide Roller, for Style 52800 T - - - - -	4
52730 H-12	Presser Foot Bottom, for Style 52800 T- - -	3
52742 C	Looper Drive Lever Rocker (spot screw No. 96 A, clamp screw No. 22852 A, washer No. 51242 M)- - - - -	13
52742 D	Looper Drive Lever (spot screw No. 22597 B, clamp screw No. 22882 A, washer No. 51242 M)- - - - -	13
52801 A	Cloth Plate, for Styles 52800 M, 52800 N, 52800 T, 52800 X (screw, countersunk head, No. 80, screw fillister head No. 22839 F)	23
52801 B	Cloth Plate, for Styles 52800 P, 52800 R, 52800 S, 52800 U, 52800 V, 52800 W, (screw, countersunk head No. 80, screw, fillister head, No. 22839 F)- - - - -	23
52802	Cloth Plate Sliding Cover, for Styles 52800 M, 52800 N, 52800 T, 52800 X- - - -	17
52802 B	Cloth Plate Sliding Cover, for Styles 52800 P, 52800 R, 52800 S, 52800 U, 52800 V, 52800 W- - - - -	17
52804	Cast-off Plate (screw No. 28) - - - - -	16
52805 B	Main Feed Dog, for Style 52800 M- - - - -	2
52805 D-16	Main Feed Dog, for Style 52800 N- - - - -	2
52805 F-8	Main Feed Dog, for Styles 52800 P, 52800 R, 52800 S, 52800 U, 52800 V - - - - -	2
52805 K	Main Feed Dog, for Style 52800 W- - - - -	2
52810 E	Main Feed Dog Screw No. 22593 Looper Needle Guard, for Styles 52800 M, 52800 N, 52800 P, 52800 R, 52800 S, 52800 T, 52800 U, 52800 V, 52800 X; also for No. 16 gauge Style 52800 W (screw No. 73 A) - - - - -	4

LIST OF PARTS

Symbol to Order By	The figures in the last column refer only to the plates illustrating the parts and are not to be used in ordering. Prices furnished on application.	Plate No.
52816	Spreader Eccentric Connecting Rod (nut, left thread No. 269, nut, right thread No. 15430 D) - - - - -	14
52816 G	Needle Lever Connecting Rod Upper Bearing (screw No. 97 A) - - - - -	15
52817-14	Needle Bar, marked "BD-14" for No. 14 gauge Style 52800 W- - - - -	14
52817-16	Needle Bar, marked "BD-16" for No. 16 gauge Styles 52800 M, 52800 N, 52800 W, 52800 X-	14
52817 E-8	Needle Bar, marked "BG-8" for No. 8 gauge Styles 52800 P, 52800 R, 52800 S, 52800 T, 52800 U, 52800 V - - - - -	14
52817 E-10	Needle Bar, marked "BG-10", for No. 10 gauge Style 52800 T- - - - -	14
52818-8	Needle Bar Set Screw No. 88 A Needle Holder (thread guide No. 52842 G, thread guide screw No. 28 B, needle holder set screw No. 88, needle set screw, right and left, No. 88 B, needle set screw, middle No. 28 C) - - - - -	10
52820 H-8	Presser Foot Assembly, for No. 8 gauge Styles 52800 U, 52800 V; one each Nos. 52830 H-8, 73 A, 91, 605, 11534, 13130 B, 22561, 22799 B, 52830 A, 52830 B - - - - -	3
52820 H-12	Presser Foot Assembly, for No. 12 gauge Styles 52800 U, 52800 V; one each Nos. 52830 H-12, 73 A, 91, 605, 11534, 13130 B, 22561, 22799 B, 52830 A, 52830 B - - - - -	3
52820 K-14	Presser Foot Assembly, for No. 14 gauge Style 52800 W; one each Nos. 52830 K-14, 73 A, 91, 605, 11534, 13130 A, 13130 B, 22799 B - - - - -	3
52820 K-16	Presser Foot Assembly, for No. 16 gauge Style 52800 W; one each Nos. 52830 K-16, 73 A, 91, 605, 11534, 13130 A, 13130 B, 22799 B - - - - -	3
52820 T-12	Presser Foot Assembly, for Style 52800 T; one each Nos. 52730 H-12, 57 WD, 91, 604, 15480 C, 52730, 52730 A, 52730 C - - - - -	3
52823	Shielded Disc Take-up (spot screw No. 96, set screw No. 22580) - - - - -	16
52824 B-16	Throat Plate, for No. 16 gauge Style 52800 M	1
52824 D-16	Throat Plate, for No. 16 gauge Style 52800 N	1
52824 F-8	Throat Plate, for No. 8 gauge Style 52800 P, 52800 R, 52800 S, 52800 U, 52800 V - - - - -	1
52824 F-12	Throat Plate, for No. 12 gauge Styles 52800 U, 52800 V - - - - -	1
52824 K-14	Throat Plate, for No. 14 gauge Style 52800 W	1
52824 K-16	Throat Plate, for No. 16 gauge Style 52800 W Throat Plate Screw No. 87	1

LIST OF PARTS

Symbol to Order By	The figures in the last column refer only to the plates illustrating the parts and are not to be used in ordering. Prices furnished on application.	Plate No.
52826	Differential Feed Dog, for No. 10 gauge Style 52800 T - - - - -	2
52826 G	Differential Feed Dog, for No. 8 gauge Style 52800 T - - - - -	2
52826 K	Differential Feed Dog, for Style 52800 W- Differential Feed Dog Screw No. 90	2
52830 A	Presser Foot Yielding Section, for Styles 52800 U, 52800 V- - - - -	4
52830 B	Presser Foot Adjustable Guide, for Styles 52800 U, 52800 V (screw No. 22561)- - - -	4
52830 H-8	Presser Foot Bottom, for No. 8 gauge Styles 52800 U, 52800 V- - - - -	3
52830 H-12	Presser Foot Bottom, for No. 12 gauge Styles 52800 U, 52800 V - - - - -	3
52830 K-14	Presser Foot Bottom, for No. 14 gauge Style 52800 W - - - - -	3
52830 K-16	Presser Foot Bottom, for No. 16 gauge Style 52800 W - - - - -	3
52834	Presser Foot Bottom Hinge Screw No. 22799 B Main Feed Bar (set screw No. 22560 B, feed dog adjusting screw No. 22747, adjusting screw lockscrew No. 22781)- - - - -	13
52834 B	Feed bar Shaft - - - - -	9
52834 H	Differential Feed Bar - - - - -	13
52834 N	Looper Drive Ball Joint Locking Nut; also for No. 39236 B - - - - -	7
52835	Differential Feed Control Lever, for Style 52800 R - - - - -	13
52835 D	Differential Feed Control Lever, rear, for Style 52800 R (nut No. 9937)- - - - -	13
52835 G	Differential Feed Control Lever Link, for Style 52800 R (screws No. 22758 B, nut No. 12934 A, lock screw No. 719)- - - - -	11
52835 K	Differential Feed Control Lever Spring, for Style 52800 R - - - - -	8
52835 N	Differential Feed Control Lever Index Plate, for Style 52800 R (screw No. 22848) - - - -	13
52835 Q	Differential Feed Fork, for Style 52800 R -	12
52835 S	Differential Feed Fork Block, for Style 52800 R (screw No. 22868 A) - - - - -	11
52835 T	Differential Feed Bar Driving Link, for Styles 52800 M, 52800 N, 52800 P, 52800 S, 52800 T, 52800 U, 52800 V, 52800 W, 52800 X	10
52835 U	Differential Feed Control Lever Link Pivot Stud Insert, for Style 52800 R- - - - -	9
52835 V	Differential Feed Bar Driving Link, for Style 52800 R - - - - -	13
52835 W	Differential Feed Control Rear Lever Link Bushing, for Style 52800 R- - - - -	9
52836	Feed Rocker (set screw No. 89)- - - - -	13

LIST OF PARTS

Symbol to Order By	The figures in the last column refer only to the plates illustrating the parts and are not to be used in ordering. Prices furnished on application.	Plate No.
52836 C	Feed Rocker Arm (clamp screw No. 22519 C, clamp screw washer No. 51235 G) - - - - -	13
52836 G	Feed Rocker Segment Slot Plate, for Styles 52800 M, 52800 N, 52800 P, 52800 S, 52800 T, 52800 U, 52800 V, 52800 W, 52800 X (screw, upper, No. 22516, screw, lower, No. 75)- - - - -	13
52836 H	Feed Rocker Segment Slot Plate, for Style 52800 R (screw No. 22516) - - - - -	13
52836 N	Feed Rocker Segment Slot Plate Shim, for Styles 52800 M, 52800 N, 52800 P, 52800 S, 52800 T, 52800 U, 52800 V, 52800 W, 52800 X - - - - -	13
52836 P	Feed Rocker Shaft Bushing, also looper rocker shaft bushing- - - - -	9
52841	Looper Drive Ball Joint Locking Stud (washer No. 8372 A, nut No. 52834 N)- - -	7
*52841 A	Looper Connecting Rod Ball Joint Assembly, left (bearing screw No. 97 A) - - - - -	10
*52841 B	Looper Connecting Rod Ball Joint Assembly, right (bearing screw No. 97 A, washer No. 51741 E)- - - - -	10
52842	Needle Bar Spreader Thread Eyelet Support (set screw No. 22560) - - - - -	10
52842 G	Needle Holder Needle Thread Guide (screw No. 28 B). - - - - -	4
52844 A	Spreader Thread Guide (screw No. 90)- - - - -	15
52845 A	Spreader (screw No. 87 U) - - - - -	4
52846	Spreader Holder (set screw No. 88)- - - - -	10
52847	Spreader Holder Carrier and Lower Presser Bar Bushing - - - - -	15
*52848 B	Spreader Connecting Rod Ball Joint Assembly, front (bearing screw No. 97 A)- - - - -	10
*52848 C	Spreader Connecting Rod Ball Joint Assembly, rear (washer No. 36 G, bearing screw No. 97 A) - - - - -	10
52849	Spreader Rock Shaft - - - - -	20
52849 B	Spreader Rock Shaft Arm (locking stud No. 55235 D, nut No. 55235 E, washer No. 6042 A) - - - - -	13
52849 C	Spreader Rock Shaft Oil Seal Collar - - - - -	9
52852 A	Spreader Rock Shaft Adjusting Segment Lever (locking screw No. 55235 D, nut No. 55235 E, washer No. 6042 A) - - - - -	13
*52854	Spreader Rock Shaft Connecting Rod Ball Joint Assembly (bearing screw No. 97 A) -	10
52855 A	Spreader Thread Take-up Eyelet (insert eyelet No. 668-25, locking ring No. 668-28, attaching screw No. 22872)- - - - -	15
52855 G	Spreader Thread Take-up (screw No. 95)- - -	15
52857 B	Cast-off Plate Support (screw No. 22528, washer No. 21657 E) - - - - -	16

* See Page 9

LIST OF PARTS

Symbol to Order By	The figures in the last column refer only to the plates illustrating the parts and are not to be used in ordering. Prices furnished on application.	Plate No.
52864 N	Folder Support Bracket, for Styles 52800 P, 52800 R, 52800 S, 52800 U, 52800 V, 52800 W (screw No. 22567) - - - - -	16
52864 P	Folder Support Hinged Bracket - - - - -	20
52864 R	Folder Support Hinged Bracket Platform, for Styles 52800 P, 52800 R, 52800 S, 52800 U, 52800 V (screw No. 90) - - - - -	17
52864 S	Folder Support Hinged Bracket Platform, for Style 52800 W (screw No. 90) - - - - -	17
52864 T	Folder Support Hinged Bracket Platform, for Styles 52800 M, 52800 N, 52800 X (screw No. 93 A) - - - - -	20
52864 U	Folder Support Hinged Bracket Platform, for Style 52800 T (screw No. 93 A) - - - - -	20
52875	Tape Clipper Frame - - - - -	15
52875 A	Tape Clipper Operating Lever (set screw No. 95, stop screw No. 22852, lock nut No. 12538) - - - - -	20
52875 B	Tape Clipper Operating Lever Shaft - - - - -	11
52875 C	Tape Clipper Lower Knife (adjusting screw No. 15447 A, attaching screw No. 22596) - -	15
52875 D	Tape Clipper Upper Knife (screw No. 93) - - -	15
52875 E	Tape Clipper Upper Knife Holder (screw No. 95) - - - - -	15
52875 F	Tape Clipper Upper Knife Holder Shaft - - - -	16
52875 G	Tape Clipper Upper Knife Tension Spring - - -	8
52875 H	Tape Clipper Knife Guard (screw No. 22829) - -	15
52875 J	Tape Clipper Cloth Guide (screw No. 604) - - -	11
52880	Throat Plate Support (screw No. 22574) - - - -	20
52882 J	Oil Reservoir Top Cover (screw, countersunk head, No. 22524, screw, fillister head No. 22585 A) - - - - -	20
52882 K	Oil Reservoir Top Cover Gasket - - - - -	20
52882 L	Oil Reservoir Back Cover (screw No. 22848) - -	20
52882 M	Oil Reservoir Back Cover Gasket - - - - -	20
52882 N	Crank Chamber Oil Reservoir Cover (screw No. 22569) - - - - -	17
52882 P	Crank Chamber Oil Reservoir Cover Gasket - - -	17
52882 Q	Crank Chamber Oil Reservoir Drip Plate (screw No. 90) - - - - -	16
52882 R	Head Cover (screw, long, No. 294, screw, short, No. 22572 A) - - - - -	20
52882 S	Head Cover Gasket - - - - -	20
52882 T	Crank Chamber Lower Cover (screw No. 22548) - -	17
52882 U	Crank Chamber Lower Cover Gasket - - - - -	17
52882 V	Stud, for attaching strip tension to head cover on Style 52800 T - - - - -	7
52883 H	Presser Foot Lifter Lever Extension - - - - -	16
52883 K	Presser Foot Lifter Lever (screw No. 22537) - -	11
52883 L	Presser Foot Lifter Lever Connecting Rod, (cotter pin No. 660-142) - - - - -	14

LIST OF PARTS

Symbol to Order By	The figures in the last column refer only to the plates illustrating the parts and are not to be used in ordering. Prices furnished on application.	Plate No.
52883 M	Presser Foot Lifter Lever Bell Crank (pivot stud No. 22557 B) - - - - -	11
52883 N	Presser Foot Lifter Lever Tension Spring- - -	8
52883 P	Presser Foot Lifter and Guide (screw No. 531)	11
52883 Q	Presser Foot Lifter Lever Connecting Link (pivot screw, upper, No. 22742, nut No. 9937, pivot screw, lower, No. 22758 B)- - -	11
52883 R	Presser Foot Lifter Lever Extension Bushing -	9
52885	Cloth Plate End Cover, for Style 52800 R- - -	23
52885 A	Cloth Plate End Cover, for Styles 52800 M, 52800 N, 52800 P, 52800 S, 52800 T, 52800 U, 52800 V, 52800 W, 52800 X - - - - -	23
52885 G	Cloth Plate End Cover Hinge, front; also right hinge for No. 52864 P (screw No. 22848)- - - - -	12
52885 H	Folder Support Hinged Bracket Hinge, left, (screw No. 22848) - - - - -	12
52885 J	Cloth Plate End Cover Hinge, rear, (screw No. 22848)- - - - -	12
52888 A	Presser Bar - - - - -	14
52888 B	Presser Bar Stop Collar (screw No. 22562) - - -	11
52889 A	Presser Bar Bushing, upper, and Presser Spring Regulator- - - - -	9
52890 C	Main Shaft Bushing, left, middle, and inner right, 3/4 inch long; also spreader rock shaft bushing - - - - -	9
*52891 A	Main Shaft Bushing Housing, includes bushing, (screw No. 22569 B) - - - - -	16
52892	Tension Post Support, for Styles 52800 P, 52800 R, 52800 S, 52800 T, 52800 U, 52800 V	15
52894 K	Spreader Connecting Rod Ball Joint Oiler; also needle bar connection link oiler (screw No. 294)- - - - -	13
52894 L	Spreader Eccentric Upper Connecting Rod Bear- ing Oil Drip Plate (screw No. 90) - - - - -	11
52894 M	Spreader Eccentric Upper Connecting Rod Bear- ing Oil Drip Plate Bracket (screw No. 90) -	11
52894 N	Needle Lever Link Oil Wiper Plate (screw No. 22513)- - - - -	11
52894 AB	Feed Lift and Looper Avoid Eccentric Oil Tube Holder- - - - -	9
52894 AC	Feed Lift and Looper Avoid Eccentric Oil Tube (screw No. 90)- - - - -	13
52894 AD	Differential Feed Bar Shaft Oil Tube (screw No. 90) - - - - -	13
52894 AE	Differential Feed Bar Guide Oil Tube (screw No. 90) - - - - -	13
52894 AF	Looper Rocker and Left Looper Connecting Rod Ball Joint Oil Tube (screw No. 22560 B) - - -	13
52894 AG	Right Looper Connecting Rod Ball Joint Oil Tube (nut No. 258 A, washer No. 6042 A) - - -	13

* See Page 9

LIST OF PARTS

Symbol to Order By	The figures in the last column refer only to the plates illustrating the parts and are not to be used in ordering. Prices furnished on application.	Plate No.
52908 B K53501	Looper (set screw No. 73) - - - - - Folder, 3/64 inch strip capacity for attaching split tube borders on Styles 52800 P, 52800 R, 7/16 inch finish, strip cut 7/8 inch wide (attaching screw No. 25 CC) - - -	4 19
53592	Tension Post Support, for Styles 52800 M, 52800 N, 52800 W, 52800 X - - - - -	15
55235 D	Spreader Rock Shaft Arm Locking Stud; also for No. 52852 A - - - - -	7
55235 E	Spreader Rock Shaft Locking Stud Nut; also for No. 52852 A - - - - -	7
55243 A	Needle Lever Ball Stud (set screw No. 22528)-	11
55244 F	Looper Rock Shaft Collar- - - - -	11
55244 G	Looper Rock Shaft Collar Stud (nut, No. 18, washer No. 20)- - - - -	7
K55752	Throat Plate, for Style 52800 X (screw No.87)	1
K55789	Folder, 5/64 inch strip capacity; for attaching collaretttes on Style 52800 V; 3/4 inch finish on top, 11/16 inch finish on bottom, strip cut 1 13/16 inches wide, top ply folded, lower ply raw (screw No. 25 CC) - -	19
K56297	Main Feed Dog, for Style 52800 X (screw No. 22593)- - - - -	2
K56821	Folder, 3/64 inch strip capacity for attaching collaretttes on Style 52800 V; 1/2 inch finish on top, 7/16 on bottom, strip cut 1 1/4 inches wide, top ply folded, lower ply raw (screw No. 25 CC) - - - - -	19
K57696	Folder, 3/64 strip capacity, for attaching collaretttes on Style 52800 V; 5/8 inch finish on top, 9/16 inch finish on bottom, strip cut 1 1/2 inches wide, top ply folded, lower ply raw (screw No. 25 CC) - -	19
K57904	Split Tube Border Measuring Gauge Assembly, maximum measuring length 12 1/2 inches, (gauge slide, front, 21198 G, gauge slide, rear, No. 21198 H, gauge slide lock nut No. 21198 J, gauge slide thumbscrew No. 22756, brace screw No. 94, attaching screw No. 25'S, washer No. 21657 E) - - - - -	19
K58937	Intermittent Strip Tension Assembly; one each Nos. 110-2, 188 D, 11663, 21182 AB, 21182 AD, 21182 AE, 21182 AF, 22504 B, 22561, 22760, 22845 A, 23439 C, K58938; two each Nos. 402, 21185 (attaching screws No. 22548)- - - - - NOTE: This assembly applies tension only when treadle is operated.	20
K58938	Intermittent Strip Tension Operating Lever, for No. K58937 (pivot stud No. 22504 B, stop screw No. 402) - - - - -	15

LIST OF PARTS

Symbol to Order By	The figures in the last column refer only to the plates illustrating the parts and are not to be used in ordering. Prices furnished on application.	Plate No.
K59055	Folder, 3/64 inch strip capacity, for attaching collarettes on Style 52800 V; 7/8 inch finish on top, 13/16 inch finish on bottom, strip cut 2 1/8 inches wide, top ply folded, lower ply raw (screw No. 25 CC) - - - - -	19
61267 G	Differential Feed Control Lever Spring Pin, for Style 52800 R - - - - -	11
61356	Presser Bar Spring - - - - -	16
K62809	Folder, 5/64 inch strip capacity, for attaching collarettes on Style 52800 V, 1 inch finish on top, 15/16 inch finish on bottom, strip cut 2 1/4 inches wide, top ply folded, lower ply raw (screw No. 25 CC) - -	19
K63004	Folder, 3/64 inch strip capacity, for attaching collarettes on Style 52800 V; 3/4 inch finish on top, 11/16 inch finish on bottom, strip cut 1 3/4 inches wide, top ply folded, lower ply raw (screw No. 25 CC) - - - - -	19
K63210	Folder, 5/64 inch strip capacity, for attaching collarettes on Style 52800 V; 7/8 inch finish on top, 13/16 inch finish on bottom, strip cut 2 inches wide, top ply folded, lower ply raw (screw No. 25 CC) - - - - -	19
K63775	Presser Foot, for Style 52800 X (clamp screw No. 91, hinge screw No. 22799 E) - - - - -	3
K64049	Folder, 3/64 inch strip capacity, for attaching collarettes on Style 52800 V; 1 inch finish on top, 15/16 inch finish on bottom, strip cut 2 1/4 inches wide, top ply folded, lower ply raw (screw No. 25 CC) - - - - -	19
K64050	Folder, 5/64 inch strip capacity, for attaching collarettes on Style 52800 V; 1 1/4 inch finish on top, 1 3/16 inch finish on bottom, strip cut 2 3/4 inches wide, top ply folded, lower ply raw (screw No. 25 CC) - - - - -	19

OILING INSTRUCTIONS

These machines are equipped with an oiling system that is almost entirely automatic. The only place that must be manually oiled occasionally is the needle lever stud which is accomplished through an oil cup in the end of the stud on the back of the machine.

The main oil reservoir which supplies oil to the looper drive eccentric, spreader drive eccentric, and needle lever crank is indicated by a lucite gauge on the front of the machine. This reservoir also serves the entire lower mechanism through a system of channels and wicks in the frame of the machine. Add only enough oil to keep the level between the red lines on the gauge. Oil is added to the main reservoir through an oil cup in the crank chamber cover on the back of the machine.

The head oil reservoir which supplies oil to the needle bar, presser bar, and other moving parts in the head is indicated by a lucite gauge in the head cover. Add only enough oil to keep the level between the red lines. Oil is added through the hole in the arm of the machine just to the left of the needle lever thread eyelet slot.

Excess oil in either reservoir may be drained at the points indicated on the oiling diagram (page 62).

Use an S.A.E. 10 W straight mineral oil and refer to oiling diagram frequently.

THREADING INSTRUCTIONS

The threading diagram (page 62) illustrates the threading of a three needle, five thread machine. All of the other styles in Class 52800, whether two or three needle, are threaded in substantially the same manner.

PL 280

NEEDLE LEVER STUD MUST BE ASSEMBLED WITH HOLE NEAREST TO PERIPHERY AT 45° TO RIGHT OF VERTICAL. (E)

FILL HEAD OIL RESERVOIR THROUGH THIS HOLE. (C)

HEAD OIL RESERVOIR GAUGE. THE OIL LEVEL SHOULD BE KEPT BETWEEN RED LINES. (B)

EXCESS OIL IN HEAD MAY BE DRAINED HERE (D)

CAUTION!

FILL ALL OIL RESERVOIRS BEFORE STARTING. MACHINE HAS BEEN DRAINED BEFORE SHIPPING. USE AN S.A.E.10W STRAIGHT MINERAL OIL.

(A) MAIN OIL RESERVOIR GAUGE. THE OIL LEVEL SHOULD BE KEPT BETWEEN THE RED LINES. EXCESS OIL IN MAIN RESERVOIR MAY BE DRAINED AT PLUG SCREW LOCATED DIRECTLY UNDER HANDWHEEL.

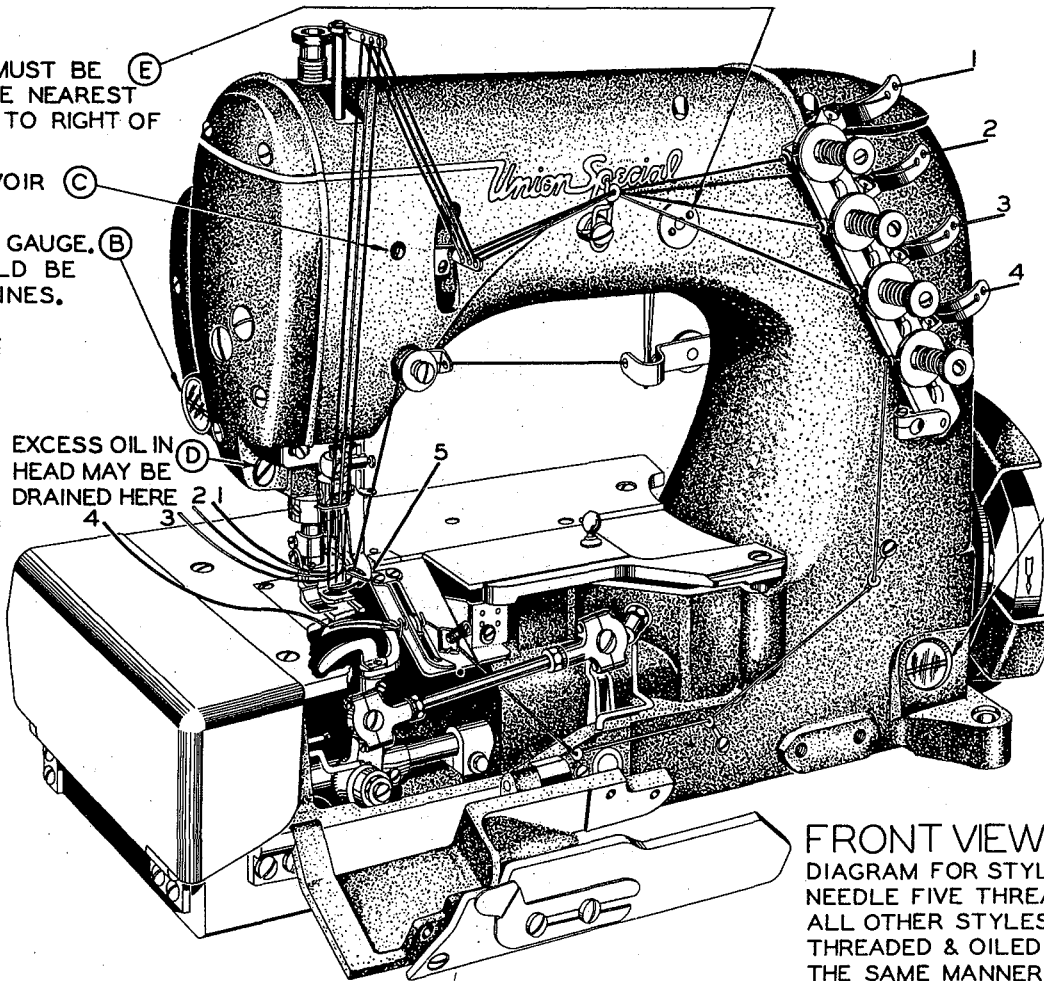
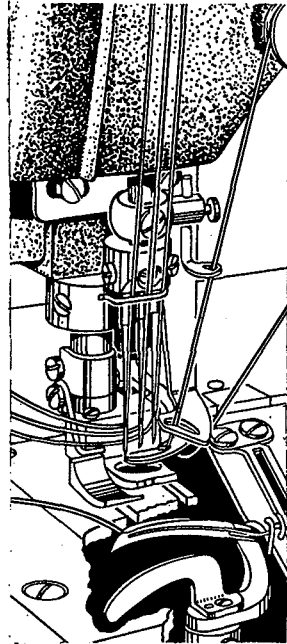

FRONT VIEW THREADING & OILING DIAGRAM FOR STYLE 52800M THREE NEEDLE FIVE THREAD MACHINE. ALL OTHER STYLES IN CLASS 52800 ARE THREADED & OILED IN SUBSTANTIALLY THE SAME MANNER. REFER ALSO TO PL 281

-62-

PRINTED IN U.S.A.

UNION SPECIAL MACHINE CO.

CHICAGO, U.S.A.

PL 281

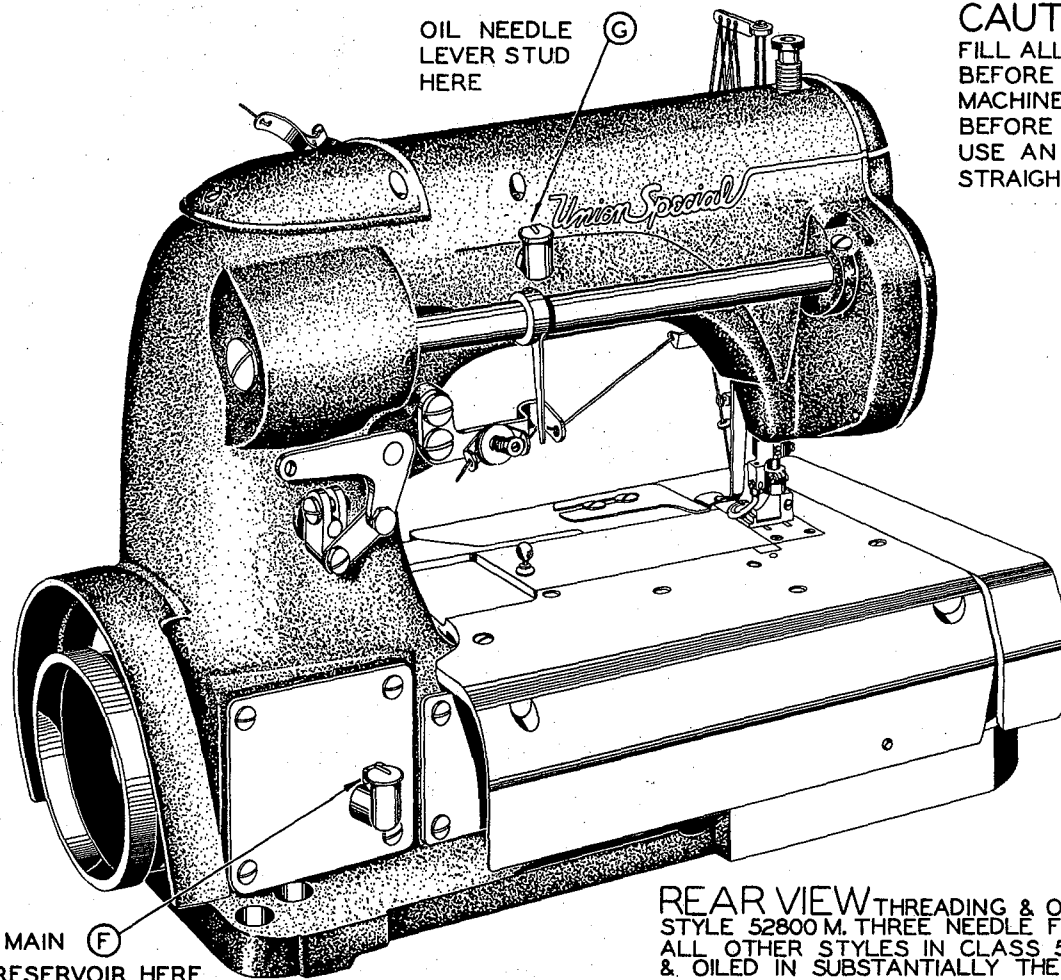

OIL NEEDLE
LEVER STUD
HERE

FILL MAIN (F)
OIL RESERVOIR HERE

CAUTION!
FILL ALL OIL RESERVOIRS
BEFORE STARTING.
MACHINE HAS BEEN DRAINED
BEFORE SHIPPING.
USE AN S.A.E. 10W
STRAIGHT MINERAL OIL.

REAR VIEW THREADING & OILING DIAGRAM FOR
STYLE 52800 M. THREE NEEDLE FIVE THREAD MACHINE.
ALL OTHER STYLES IN CLASS 52800 ARE THREADED
& OILED IN SUBSTANTIALLY THE SAME MANNER.
REFER ALSO TO PL 280

PRINTED IN U.S.A.

UNION SPECIAL MACHINE CO. CHICAGO, U.S.A.

-63-

In addition to the machines described in this catalog Union Special also manufactures other machines for the knit goods industry.

Listed below are some of the other Styles available. Additional information covering these machines may be had by contacting the Union Special representative nearest you or by addressing your inquiry to the main office at Chicago.

OVEREDGERS

Machine Style	Description
39200 AC	For seaming the lighter weight materials. Seam specification 504-SSa-1
39200 AD	For seaming the lighter weight materials. Seam specification 503 SSa-1
39200 AE	For seaming all weights of materials. Seam specification 504 SSa-1
39200 AN	For overedging collars and fronts of knitted union suits and shaping ends of collars. Seam specification 505 EFD-1
39200 AS	For blind stitch welting or hemming on light weight materials. Seam specification 503 EFC-1
39200 AT	General utility four-way combination two thread stitch and three thread stitch for seaming and welting. Seam specifications 503 SSa-1, 504 SSa-1, 503 EFC-1, 504 EFC-1
39200 AW	General utility, two-way combination three thread stitch for seaming and welting. Seam specifications 504 SSa-1, 505 EFC-1

FLAT BEDS

51200 V	Single needle, for attaching one piece extension button stays. Seam specification 401 BSc-1
51700 L	Two needle, for folding and attaching buttonhole facings in one operation. Seam specification 401 LSk-2
52100 A	Two needle, for attaching split tube borders to necks and armholes on garments made from light weight knitted cotton and rayon. Seam specification 402 BSc-1
52700 M	Three needle, for attaching elastic bands. Seam specification 407 LSb-1
52700 N	Two needle, for attaching elastic bands. Seam specification 406 LSb-1

LOCKSTITCH

61300 H	Single needle, for seaming light to medium weight material
61300 L	Single needle, for seaming medium to heavy weight material

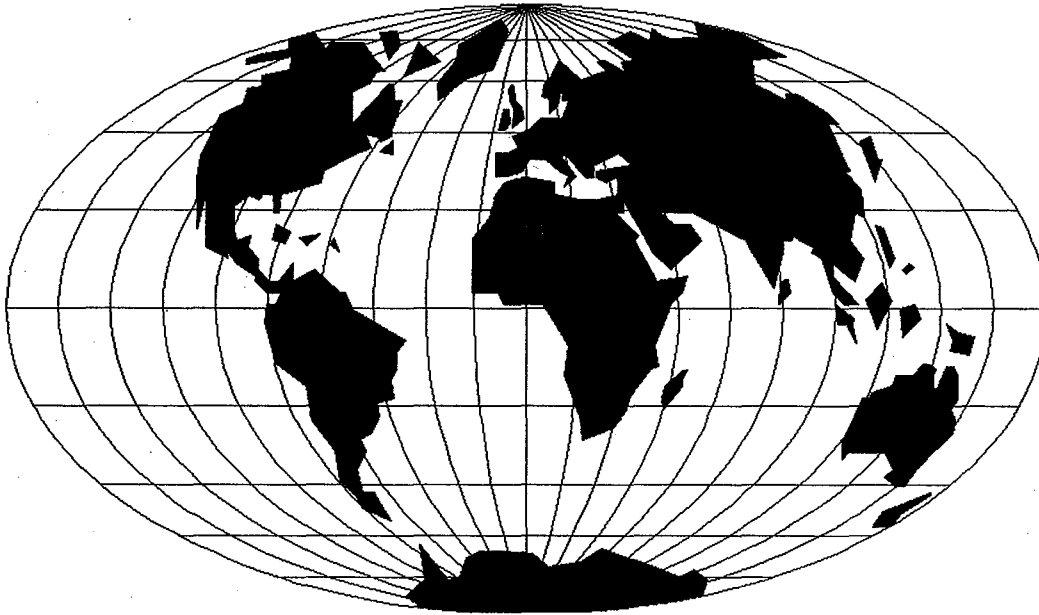

WORLDWIDE SALES AND SERVICE

Union Special Corporation maintains sales and service facilities throughout the world. These offices will aid you in the selection of the right sewing equipment for your particular operation. Union Special Corporation representatives and service technicians are factory trained and are able to serve your needs promptly and efficiently. Whatever your location, there is a qualified representative to serve you.

Corporate Office: One Union Special Plaza
Huntley, IL 60142
Phone: 847-669-5101
Fax: 847-669-1096

European Distribution Center: Union Special GmbH
Raiffeisenstrasse 3
D-71696 Möglingen, Germany
Tel: 49-07141-247-0
Fax: 49-7141-247-100

Brussels, Belgium
Charlotte, N.C.
El Paso, TX
Hong Kong, China
Huntley, IL
Leicester, England
Lille, France
Miami, FL
Milan, Italy
Möglingen, Germany
Montreal, Quebec
Osaka, Japan
Santa Fe Springs, CA

Other Representatives throughout
all parts of the world.



Union Special
INDUSTRIAL SEWING EQUIPMENT