



*Union Special*<sup>®</sup>  
INDUSTRIAL SEWING EQUIPMENT

**STYLES**

**ADJUSTING INSTRUCTIONS AND  
ILLUSTRATED PARTS LIST**

**51100**

**51200**

---

---

**51300**

**51400**

**LIST OF PARTS AND INSTRUCTION**

**51500**

**51700**

---

---

**51900**

**CATALOG  
NO. 70L**

**FIRST  
EDITION**

**FIRST EDITION**  
**© 1957**

**PRINTED 1996 IN USA**

**INFORMATION SUBJECT TO CHANGE WITHOUT NOTICE**

**© UNION SPECIAL CORPORATION ALL RIGHTS RESERVED IN ALL COUNTRIES.**

## IDENTIFICATION OF MACHINES

Each Union Special carries a style number which is stamped in the name plate on the machine. Style numbers are classified as standard and special. Those which are standard have one or more letters suffixed but never contain the letter "Z". Example: 51400 A. Style numbers contain the letter "Z" are special. When only minor changes are made in a standard machine a "Z" is merely suffixed to the respective standard style number. Example: 51400 AZ.

Styles of machines similar in construction are grouped under a class number which differs from the style numbers in that it contains no letters. Example: 51400.

The distance between the rows of stitches is represented by a gauge number measured in 64ths of an inch, viz: 9 gauge represents a distance of 9/64 inch; 64 gauge represents a distance of 64/64 inch, or 1 inch. The gauge number of machines, making three independent equally spaced rows of stitches, represents the space between adjoining rows or one-half the overall measurement, viz: No.6 gauge represents 6/64 inch or 3/32 inch, No.9 gauge represents 9/64 inch.

### STYLES OF MACHINES IN CLASS 51100

Enclosed Type Flat Bed One Needle Machines, for Manufacturing Bags Made From Medium and Light Weight Fabrics

51100 A (Succeeds Styles 1800 A, 1800 AA, 1900 A, 1900 AA). For seaming large and medium size bags made from light and medium weight burlap; one needle, double locked stitch Type 401, stitch range 6 to 3 per inch, Type 143 needle.

51100 B (Succeeds Styles 1800 C, 1800 AC). For seaming small size bags made from light weight cotton, one needle, double locked stitch Type 401, stitch range 8 to 5 per inch, Type 124 needle.

51100 C For seaming large size bags made from light weight cotton; one needle, double locked stitch Type 401, stitch range 6 to 3 per inch, Type 143 needle.

51100 Z A special style similar to the standard styles in Class 51100, but differing in one or more of its component parts.

### STYLES OF MACHINES IN CLASS 51200

Enclosed Type Flat Bed One Needle Light Duty Machines, Double Locked Stitch Type 401, Work Space to Right of Needle Bar  $8\frac{1}{2}$  Inches.

51200 A (Succeeds Styles 6400 I, 15900 D). For binding aprons, dresses and similar garments; Type 106 needle, uses cut edge strip, standard width 3/4, 7/8, 1, 1 1/8 and 1 1/4 inches.

51200 B (Succeeds Style 6400 M). For seaming mattress ticks, bound seam, uses selvage edge strip, standard widths 5/8, 3/4 and 7/8 inch, English binder, Type 126 needle.

STYLES OF MACHINES IN CLASS 51200 (Cont'd)

- 51200 C (Succeeds Style 6400 W). For seaming mattress ticks; plain seam, Type 126 needle.
- 51200 D (Succeeds Styles 1700 F, 1700 H). For seaming canton flannel and jersey cloth gloves, also leather palm gloves; Type 101 needle.
- 51200 E (Succeeds Style 6200 B). For attaching side stays to shoe linings; flat presser foot with yielding spring guide, Type 301 needle.
- 51200 G (Succeeds Style 6400 N). For joining shoulders of shirts; one operation, Type 106 needle.
- 51200 Z A special style similar to the standard styles in Class 51200, but differing in one or more of its component parts.

STYLES OF MACHINES IN CLASS 51300

Enclosed Type Flat Bed One Needle Heavy Duty Machines, Double Locked Stitch Type 401, Work Space to Right of Needle Bar 8 1/2 Inches.

- 51300 A (Succeeds Styles 6500 B, 15900 A). For seaming trousers, coats and similar garments; Type 128 needle.
- 51300 B (Succeeds Style 6600 E). For seaming ouch covers, with and without rope welt; welt guided to left of needle, Type 143 needle.
- 51300 Z A special style similar to the standard styles in Class 51300, but differing in one or more of its component parts.

STYLES OF MACHINES IN CLASS 51400

Enclosed Type Flat Bed Independent Row Two Needle Light Duty Machines, Left Needle in Front, 5/32 Inch Space Between Needles in Line with Feed, Double Locked Stitch Type 401, Work Space to Right of Needle Bar 8 1/2 Inches.

- 51400 A (Succeeds Styles 7400 A, 7400 B). For piecing sleeves, joining shoulders and setting sleeves of shirts and similar garments made of medium and light weight materials; double stitch felled seam, Type 106 needles, standard gauges Nos. 8, 10, 12, 16 and 18.
- 51400 B (Succeeds Style 7400 X). For folding and attaching extension center plait, interlining strip and facing strip to fronts of shirts and similar garments; one operation, plaits used in garment lengths and extend 1/4 inch beyond the rows of stitches, facing and interlining strips used in long lengths, starts operation at neck, standard upper folder is suspended, Type 106 needles, standard gauge No. 48.
- 51400 C (Succeeds Style 7400 AH). For folding and attaching set-on center plait and interlining strip; otherwise same as 51400 B.

STYLES OF MACHINES IN CLASS 51400 (Cont'd)

- 51400 D (Succeeds Style 7400 AL). For folding and attaching inside button facing to shirts and similar garments; one operation, facing strip used in long lengths and guided next to feed dog, starts operation at neck, Type 106 needles, standard gauges Nos. 32 and 48.
- 51400 Z A special style similar to the standard styles in Class 51400, but differing in one or more of its component parts.

STYLES OF MACHINES IN CLASS 51500

Enclosed Type Flat Bed Independent Row Two Needle Heavy Duty Machines, Left Needle in Front, 3/16 Inch Space Between Needles in Line With Feed, Double Locked Stitch Type 401, Work Space to Right of Needle Bar 8 1/2 Inches

- 51500 A (Succeeds Style 7500 B). For double stitch felling overalls, coats, combination suits and similar garments, Type 128 needles, standard gauges Nos. 16 and 18.
- 51500 Z A special style similar to the standard styles in Class 51500, but differing in one or more of its component parts.

STYLES OF MACHINES IN CLASS 51700

Enclosed Type Flat Bed Independent Row Two Needle Machines, Needles Abreast, Double Locked Stitch Type 401, Work Space to Right of Needle Bar 8 1/2 Inches

- 51700 C (Succeeds Styles 16200 N, 16200 Q). For folding and attaching set-on center plait and interlining strip to fronts of shirts and similar garments, one operation, plaits used in garment lengths and extend 1/4 inch beyond the rows of stitches, starts operation at neck, standard folder is suspended, Type 106 needles, standard gauges Nos. 56 and 64.
- 51700 D (Succeeds Styles 16200 D, 16200 P). For folding and attaching extension center plait, interlining strip and facing strip, standard gauge No. 64; otherwise same as 51700 C.
- 51700 Z A special style similar to the standard styles in Class 51700, but differing in one or more of its component parts.

STYLES OF MACHINES IN CLASS 51900

Enclosed Type Flat Bed Independent Row Three Needle Machines, Left Needle in Front, 5/32 Inch Space Between Needles in Line With Feed, Double Locked Stitch Type 401, Work Space to Right of Needle Bar 8 1/2 Inches.

- 51900 A (Succeeds Style 17100 B). For piecing sleeves, joining shoulders, and setting sleeves of shirts and similar garments made from medium and light weight materials, triple stitch felled seam, needles Type 106, standard gauges Nos. 5, 6 and 7.

## STYLES OF MACHINES IN CLASS 51900 (Cont'd)

51900 B (Succeeds Style 17100 C). For seaming overalls, coats, combination suits and similar garments; triple stitch felled seam, needles Type 128, standard gauges Nos. 7, 8 and 9.

51900 Z A special style similar to the standard styles in Class 51900, but differing in one or more of its component parts.

## APPLICATION OF CATALOG

This catalog applies only to the standard styles and gauges of machines as listed. It can also be applied with discretion to the special machines in the "Fifty Thousand Series".

## NEEDLES

### TYPE NUMERS AND SIZES

Each needle has a type number and size number. The former denotes the kind of shank, point, length, groove, finish, and other details. The latter denotes the largest diameter of the blade, measured in thousandths of an inch midway between the shank and eye, and is stamped in the needle shank. Collectively the type number and size number is the complete symbol.

To have orders promptly and accurately filled, the empty package, a sample needle, or the type and size numbers should be given. See marks on packages. An intelligent order would read as follows: "1000 Needles Type 106 Size .036". The type numbers of the needles most commonly used in the styles of machines covered by this catalog are listed below. Set opposite each type number is the definition of the needle.

Type No.	Definition
101	Round shank, round point, extra short, double groove, nickel plated.
106	Round shank, round point, extra short, double groove, ball eye, nickel plated.
108	Round shank, round point, extra short, double groove, ball eye, spotted, nickel plated.
109	Round shank, round point, extra short, double groove, ball eye, government, nickel plated.
110	Round shank, round point, extra short, double groove, ball eye, government, spotted, nickel plated.
121	Round shank, round point, short, double groove, nickel plated.
124	Round shank, round point, short, double groove, spotted, nickel plated.
126	Round shank, round point, short, double groove, ball eye, nickel plated.
128	Round shank, round point, short, double groove, ball eye, spotted, nickel plated.

NEEDLES (Cont'd)

Type No.	Definition
130	Round shank, short, double groove, ball eye, government, spotted, nickel plated.
140	Round shank, long, double groove, nickel plated.
143	Round shank, round point, No. 2 bag, double groove, nickel plated.
144	Round shank, round point, No. 2 bag, double groove, short point, nickel plated.
301	Round shank, stay point, extra short, double groove.
907	Round shank, spear point, extra short, double groove, ball eye, nickel plated.
929	Round shank, spear point, short, double groove, ball eye, spotted, nickel plated.
943	Round shank, spear point, No. 2 bag, double groove.

APPLICATION OF TYPE NUMBERS

The styles of machines covered by this catalog are listed below. Set opposite each style number is the type number or numbers, of the needle generally used. Type numbers are arranged numerically, as the variety of the materials sewed on each machine makes it impractical to show a preference.

Machine Style	Type of Needles
51100 A	140, 143, 144, 943
51100 B	124
51100 C	124
51200 A	106, 108, 109, 110, 907
51200 B	126, 128, 130, 929
51200 C	126, 128, 130, 929
51200 D	101, 106, 108, 907
51200 E	101, 106, 301
51200 G	106, 108, 109, 110, 907
51300 A	126, 128, 130, 929
51300 B	140, 143, 144, 943
51400 A	106, 108, 109, 110, 907
51400 B	106, 108, 109, 110, 907
51400 C	106, 108, 109, 110, 907
51400 D	106, 108, 109, 110, 907

## NEEDLES (Cont'd)

### APPLICATION OF TYPE NUMBERS (Cont'd)

Machine Style	Type of Needles
51500 A	126, 128, 130, 929
51700 C	106, 108, 109, 110, 907
51700 D	106, 108, 109, 110, 907
51900 A	106, 108, 109, 110, 907
51900 B	126, 128, 130, 929

### ORDERING REPAIR PARTS

#### PLATES

Grouped, according to scale, will be found illustrations of parts similar in appearance and, to some extent, component parts that go in the same subdivisions of the mechanism.

When a given design of presser foot, looper, throat plate or other part is made in two or more gauges or sizes, only one illustration is usually shown. In ordering these pieces, it is necessary that the additional information be furnished as requested under these illustrations.

#### LIST OF PARTS

Turning from the plates to the list of parts, the definition of each part and its principal uses will be found. Always check the symbol against its definition before ordering. It is not necessary to furnish the plate number.

When a part is used, or can be used in all machines covered by this catalog, no specific use is mentioned in the definition.

For convenience in ordering, minor parts such as screws, nuts and similar articles are repeated after each major part.

(-) A dash in the "plate number" column of the list of parts indicates the absence of an illustration.

(□) A square in the "symbol to order by" column indicates that the part is commercial and can be readily purchased in any machinist's supply house.

(‡) A double dagger in the "symbol to order by" column indicates that the component parts cannot be furnished separately.

#### IDENTIFYING PARTS

Where the construction permits, each part is stamped with its part number. Some of the smaller parts are stamped with an identification letter to distinguish them from parts similar in appearance.

All part numbers represent the same part, regardless of the catalog in which they appear.

#### SUPPLIES

All supplies, including taps, reamers, belting, belt hooks, belt fasteners, screw drivers, wrenches and powdered oil stone will be promptly furnished.

#### USE GENUINE NEEDLES AND REPAIR PARTS

Success in the operation of these machines can be secured only by the use of genuine Union Special Needles and Repair Parts as furnished by the Union Special Machine Company, its subsidiaries and authorized distributors. Obviously, it is to



## ORDERING REPAIR PARTS (Cont'd)

### USE GENUINE NEEDLES AND REPAIR PARTS (Cont'd)

our interest to maintain the reputation of Union Specials by furnishing the very best goods obtainable. They are designed according to the most approved scientific principles, and are made with the utmost precision. The maximum efficiency and durability are assured.

Genuine needles are put up in packages marked at the top, "Trade 'UNION SPECIAL' mark". Genuine repair parts are stamped with a reproduction of the well known two padlocks with a link connecting the shackles. Both trade marks are symbolic of superlative excellence. All other needles and parts are bogus.

### TERMS

Prices are strictly "net cash" and subject to change without notice. Express and freight shipments are forwarded at the buyer's risk, f.o.b. shipping point. Parcel post shipments are insured unless otherwise directed. A charge is made to cover the postage and insurance.

Plate 1- Full Size

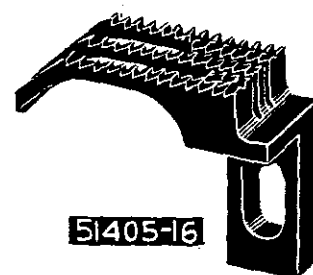
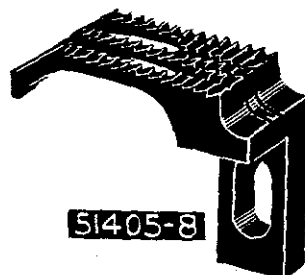
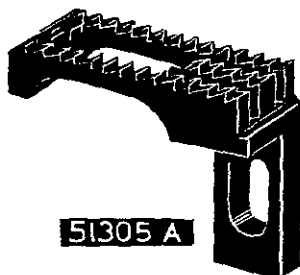
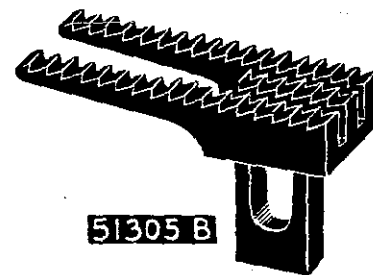
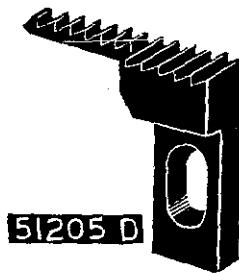
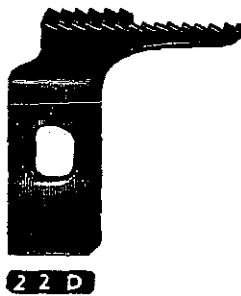
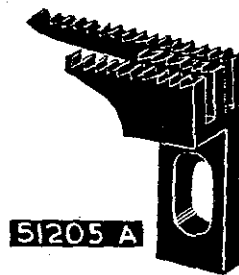
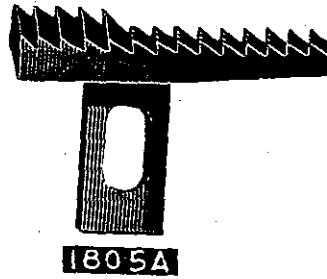
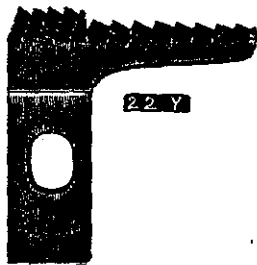
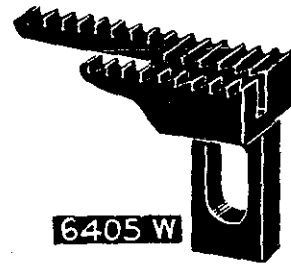
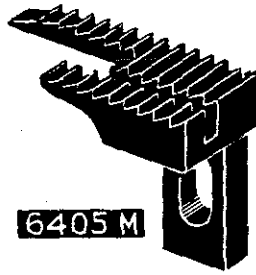
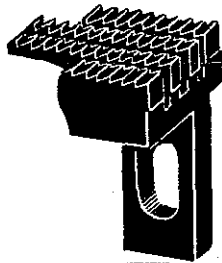
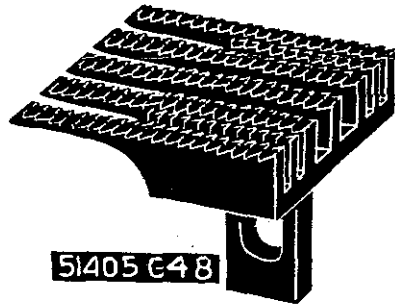

Plate 2- Full Size



51405 B-32



51405 C48

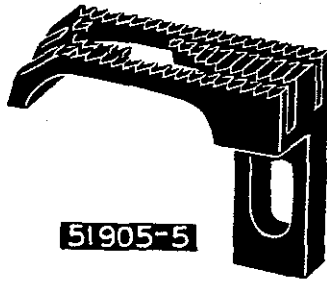

51905-5

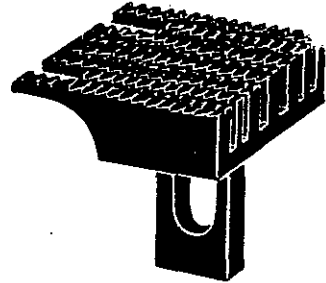

51405 B-48

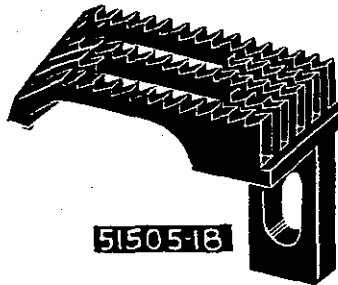

51505-18

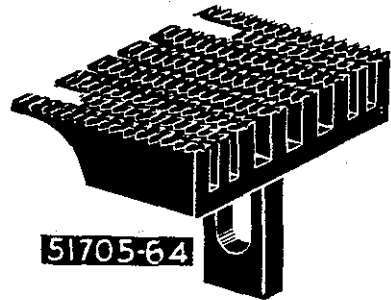

51705-64

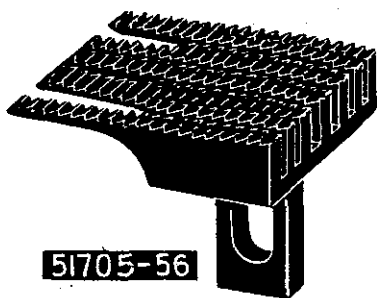

51705-56

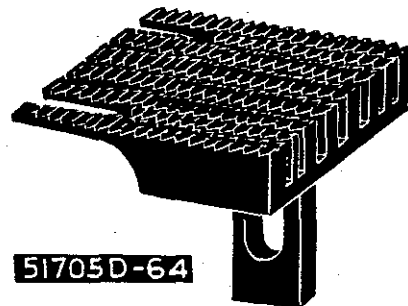

51705D-64

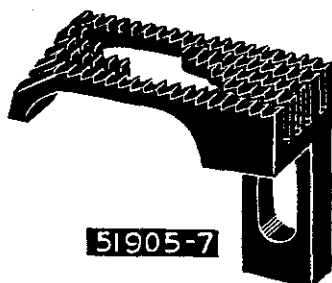

51905-7

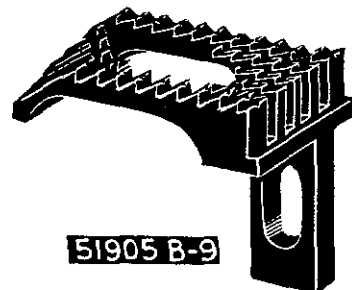

51905 B-9

Plate 3- Full Size

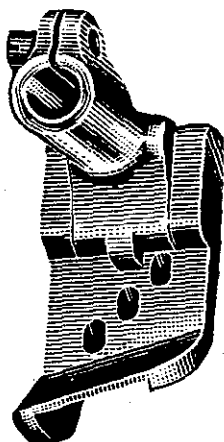

**35820 P**

Specify Gauge

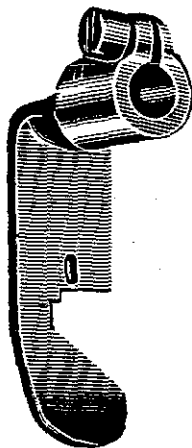

**51220 A**

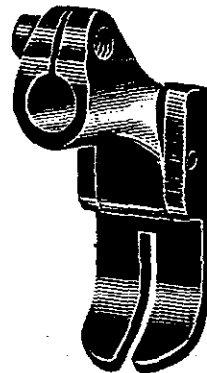

**6520**

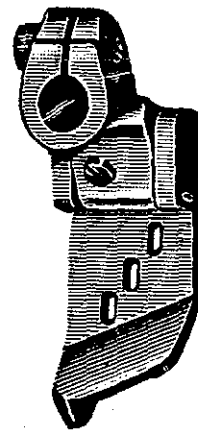

**51920**

Specify Gauge

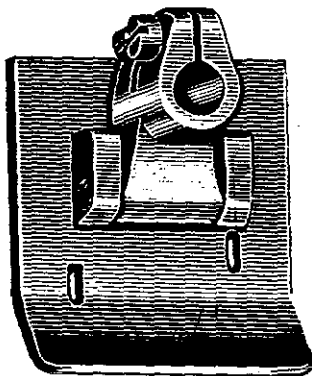

**51420 C**

Specify Gauge

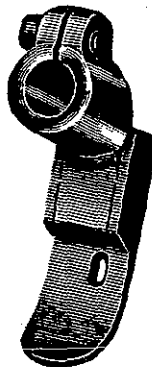

**1727 A**

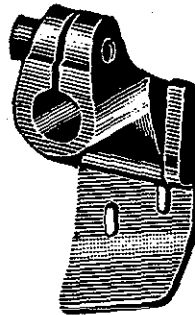

**51420**

Specify Gauge

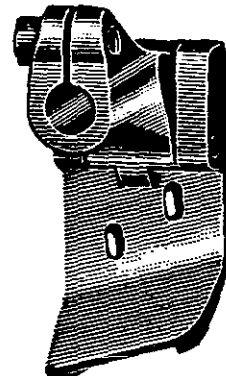

**51520**

Specify Gauge

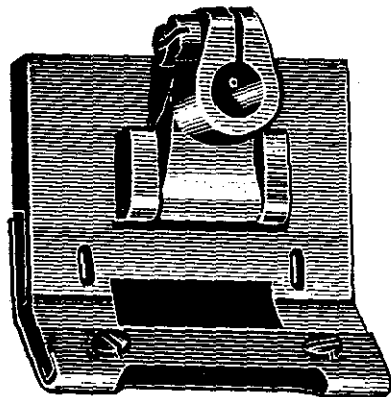

**51720**

Specify Gauge

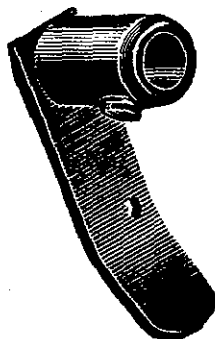

**51120 B**

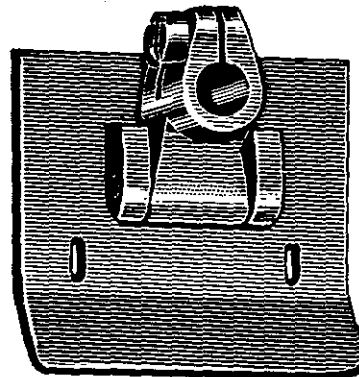

**51720 D-64**

Plate 4- Full Size

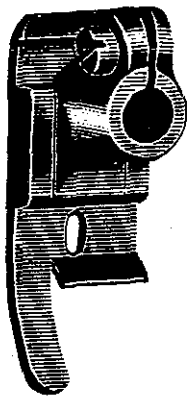

6420 W

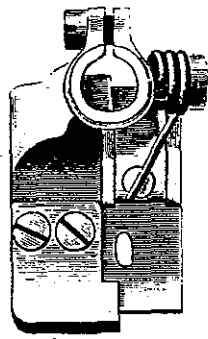

9720

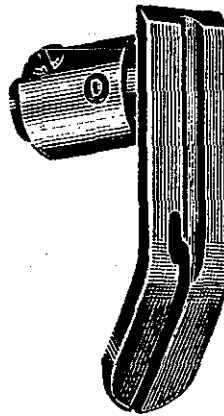

51320 B

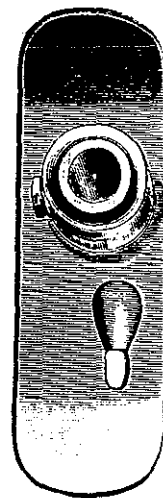

65 X



1741 B



6235

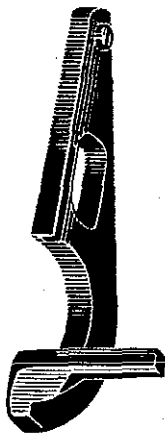

51225



51220 E



51730 A

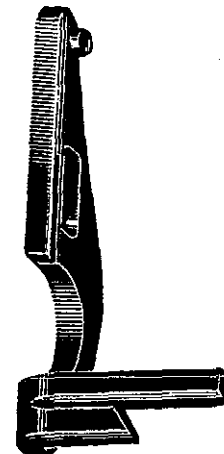

51425

Specify Gauge

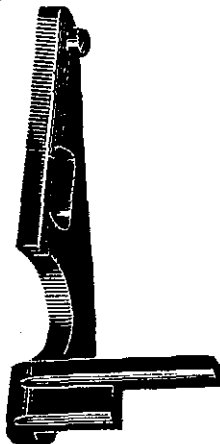

51525

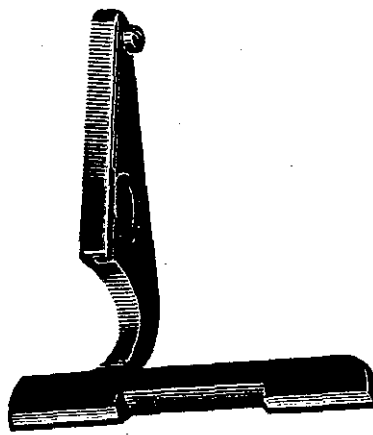

51725

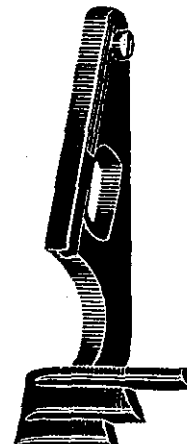

51925

Plate 5- Full Size

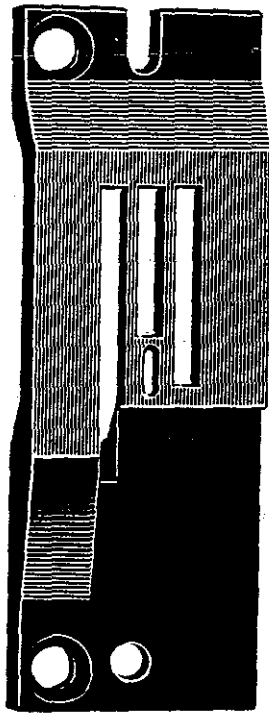

51224 A

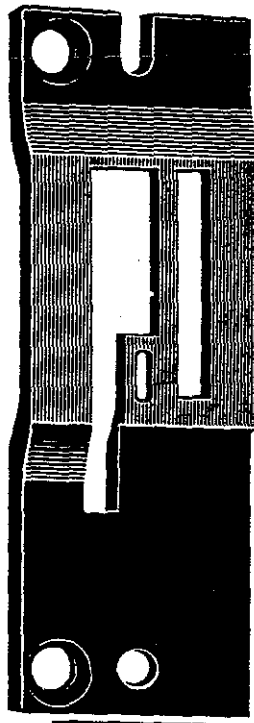

51224 B

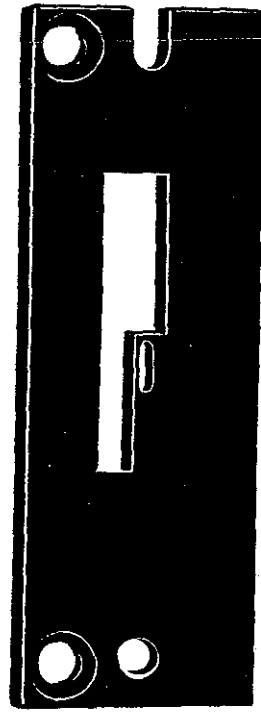

51224 D

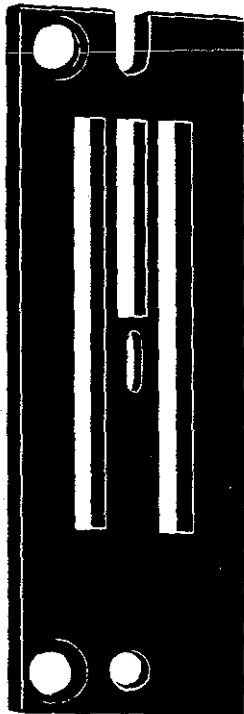

51324 B

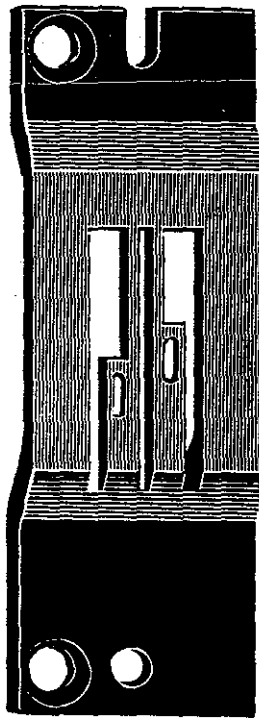

51424

Specify Gauge

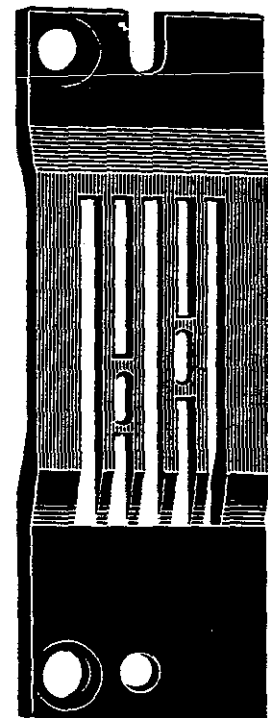

51524

Specify Gauge

Plate 6- Full Size

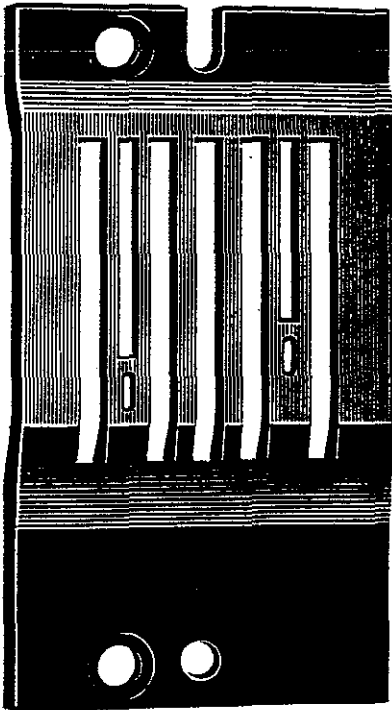

51424 C-48

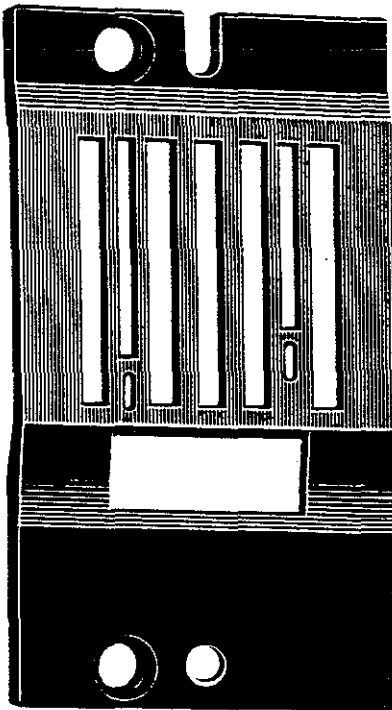

51424 B

Specify Gauge

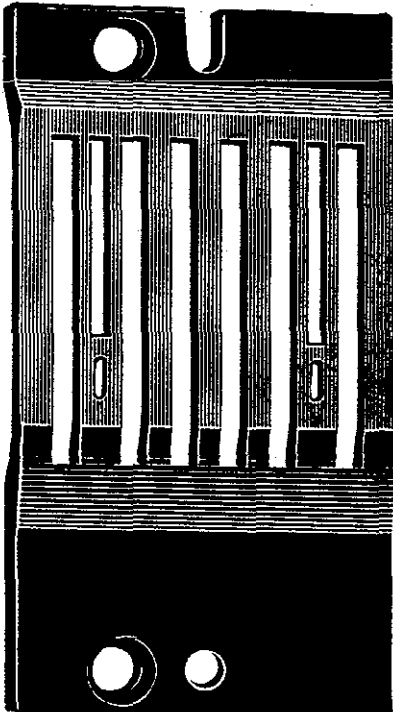

51724

Specify Gauge

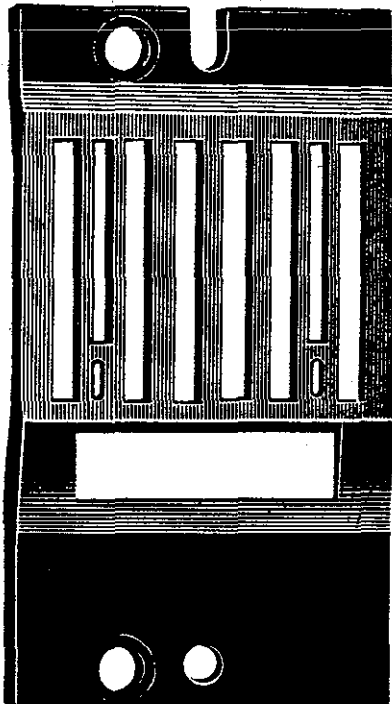

51724 D-64

Plate 7- Full Size

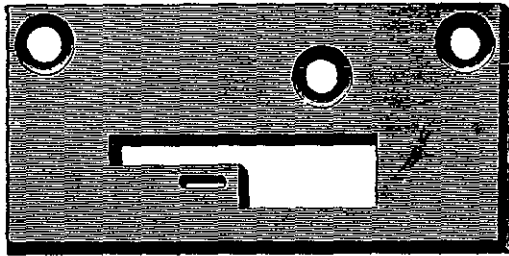

6224 B

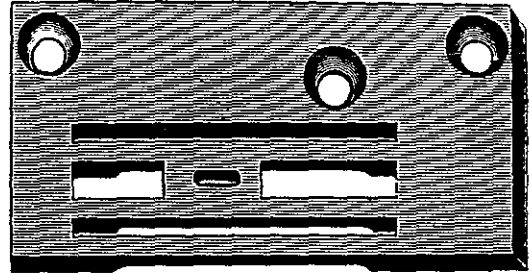

9224 E

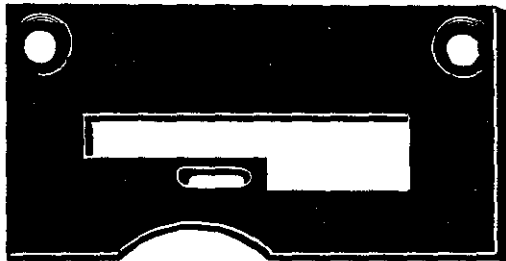

51124 B

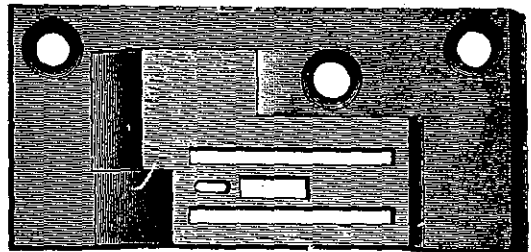

9724

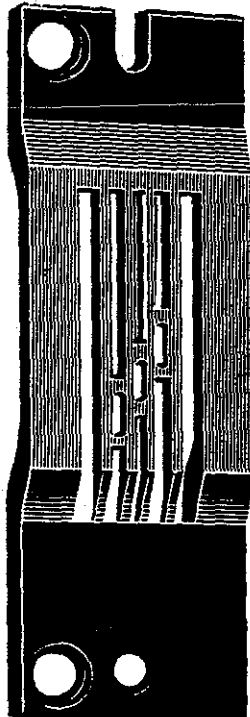

51924

Specify Gauge

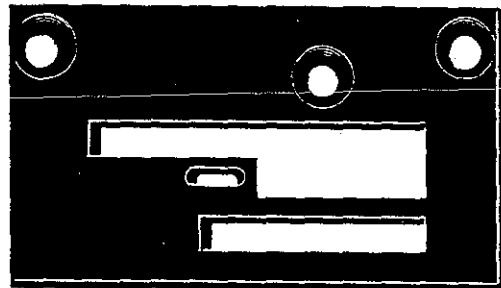

6424 W



51124 A

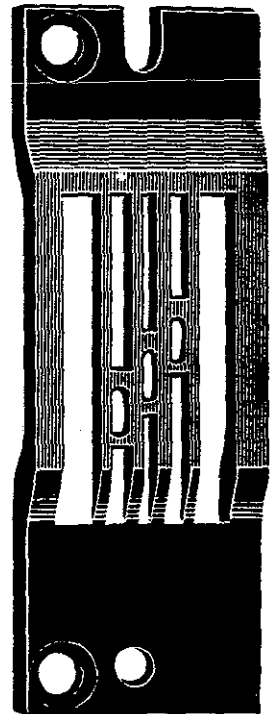

51924 B

Specify Gauge



Plate 8- Full Size

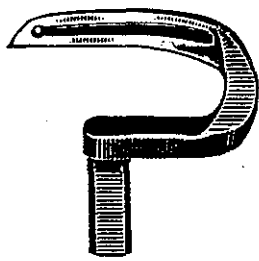

51108

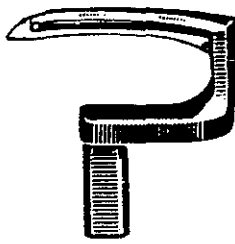

51208

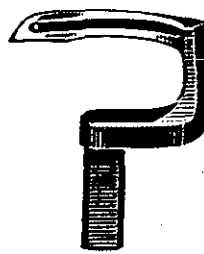

51208 D

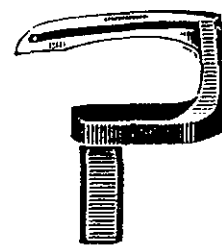

51408

Specify Gauge

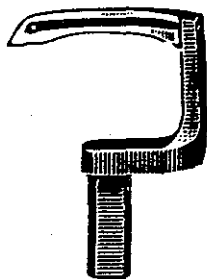

51409

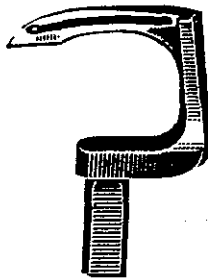

51409 B

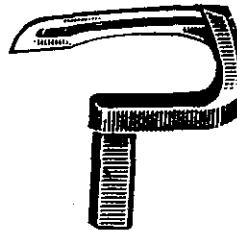

51508

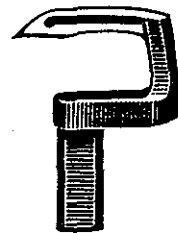

51708

Specify Gauge

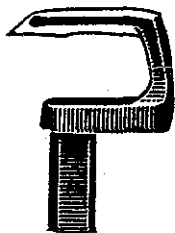

51709

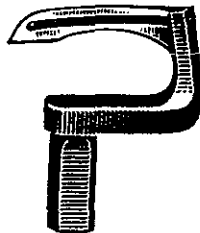

51908

Specify Gauge

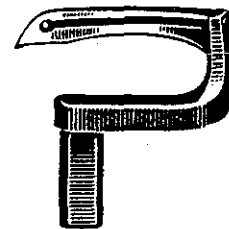

51908 A

Specify Gauge

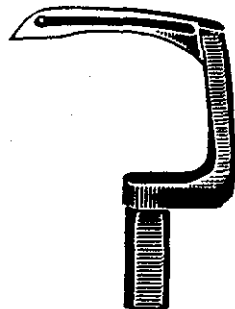

51909

Specify Gauge

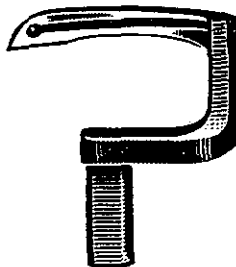

51909 B

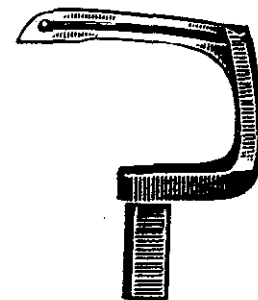

51909 A

Specify Gauge.

Plate 9- Full Size

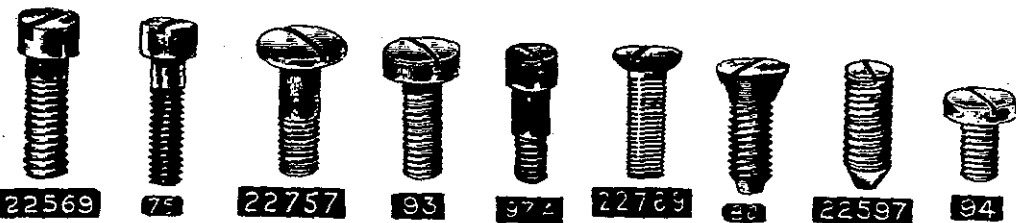
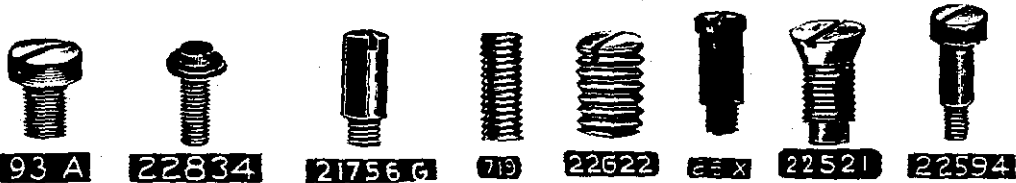
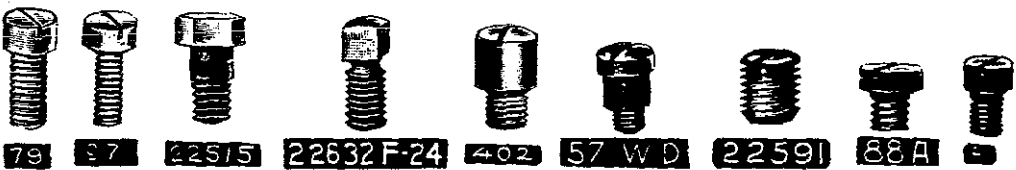
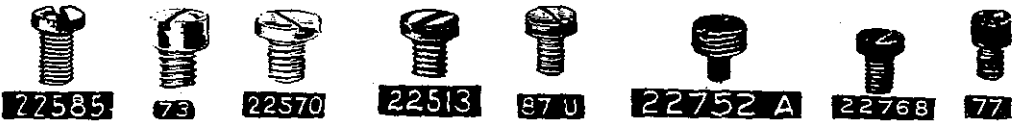

Plate 10- Full Size



Plate 11- Full Size

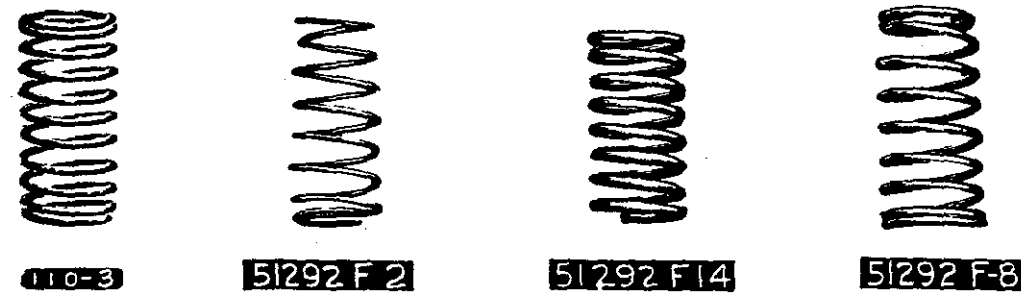
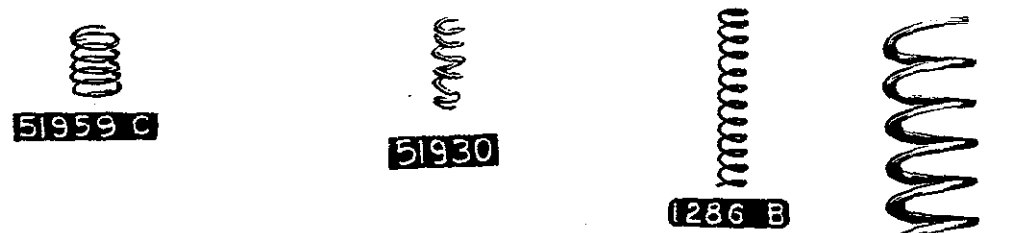
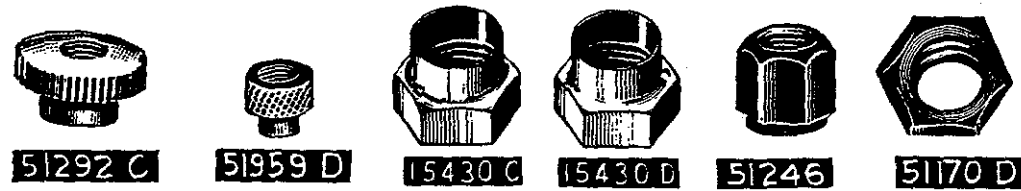

Plate 12- Full Size

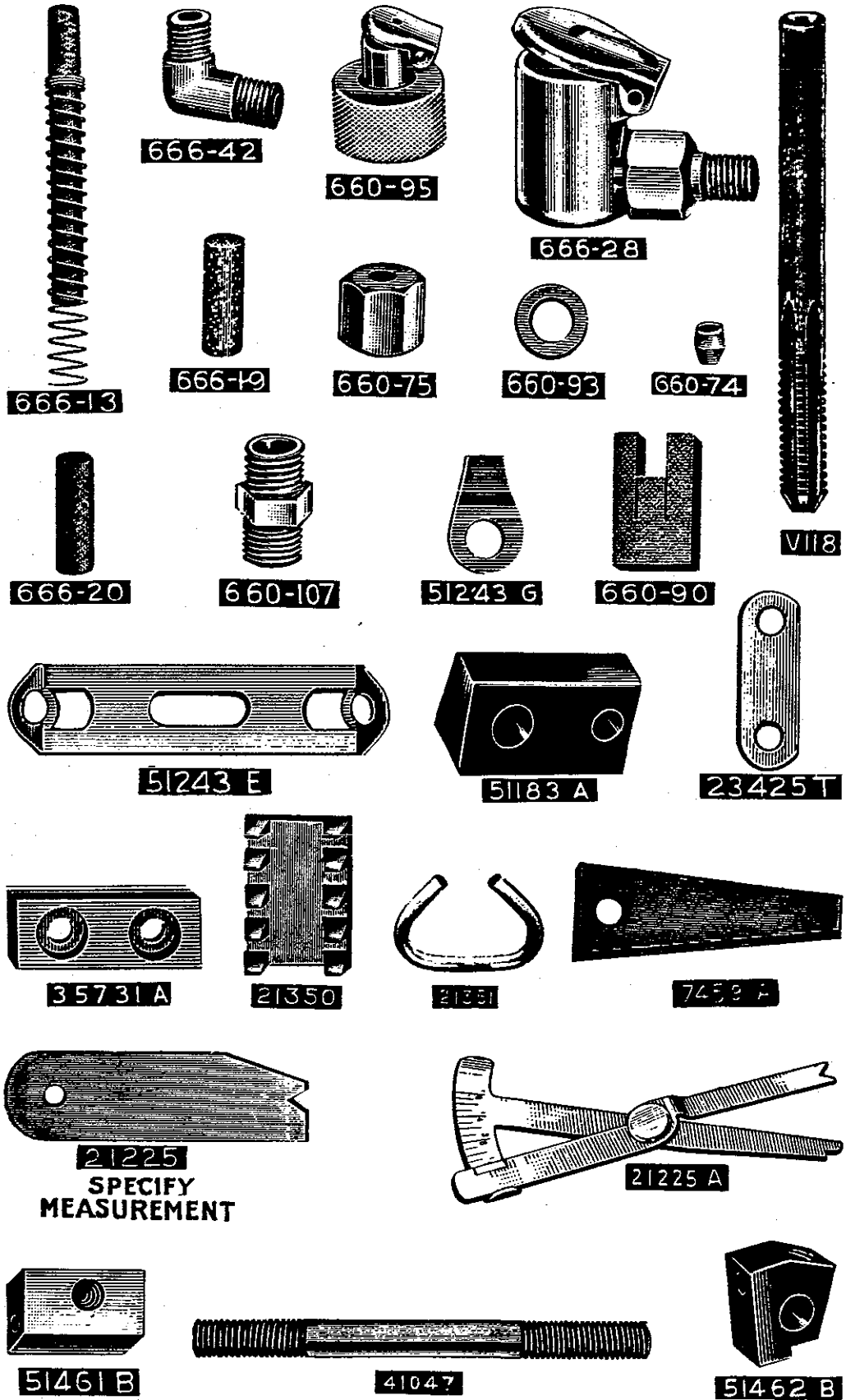

Plate 13- Full Size

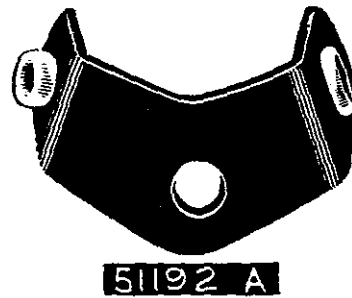
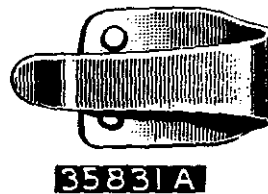
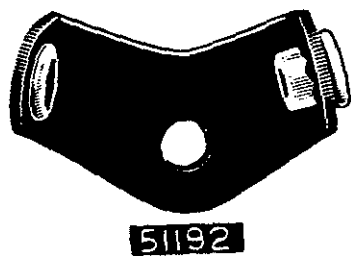
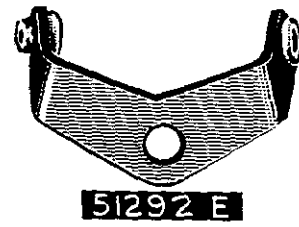
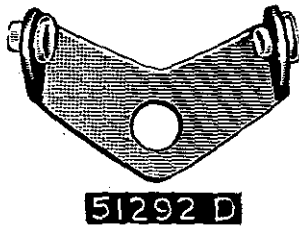
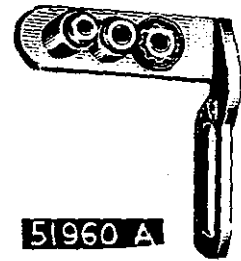
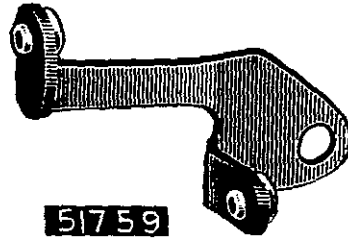
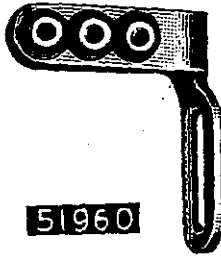
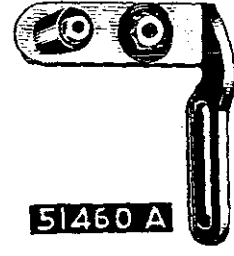
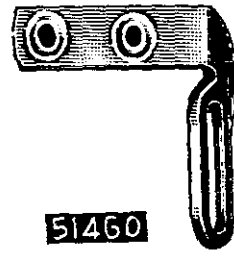
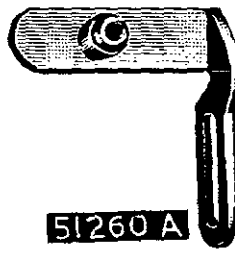
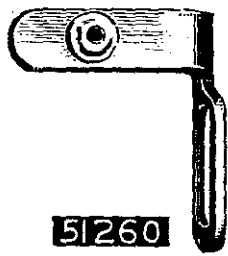

Plate 14- Full Size



35558 A



51758



137



52-A

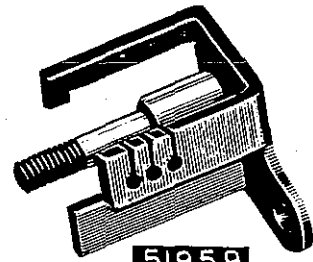

51959



51758 A

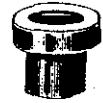

1347

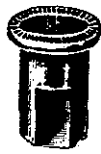

107



103



57-W.B.



51292 B



109



57-W.A.



51959 B



1346



7933-48



7018E-5



51292 A



51170 C



51418 B

Specify Gauge



51918

Specify Gauge

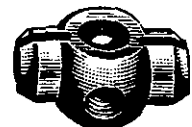

35818N

Specify Gauge



8118-64

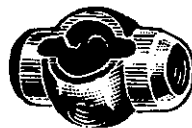

51418-16



16152

Specify Gauge

Plate 15- Full Size

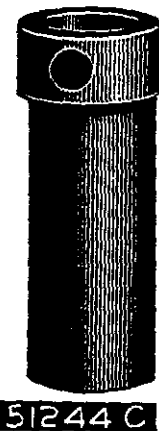
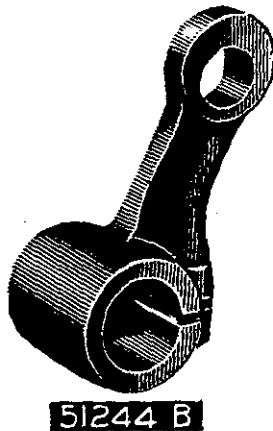
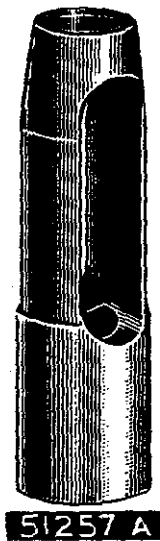
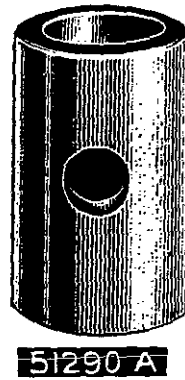
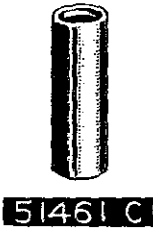
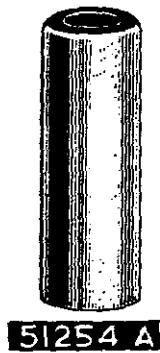
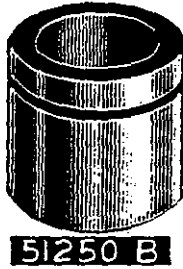
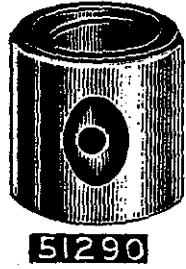
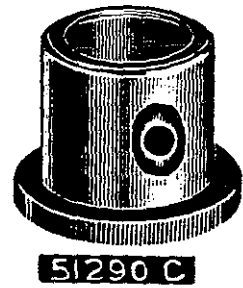
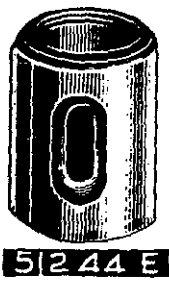
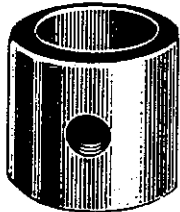
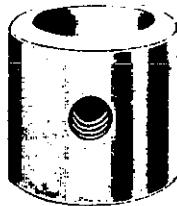



Plate 16- Full Size



51142



43

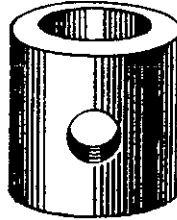

43C

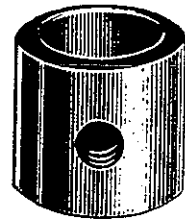

51142 A

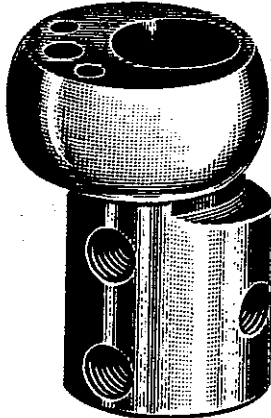

51443

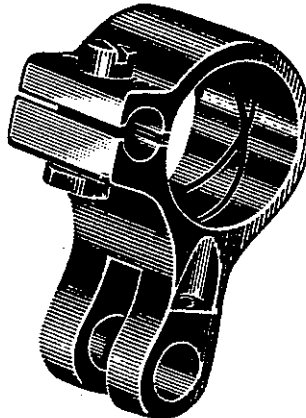

51245

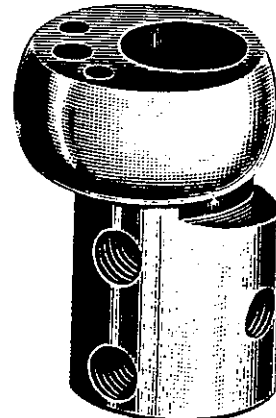

51343

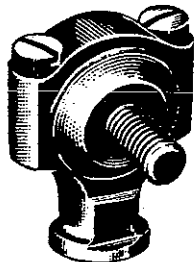

51741 B

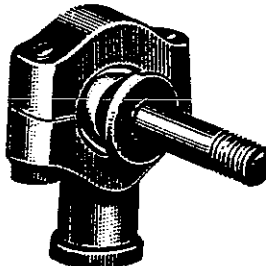

51741

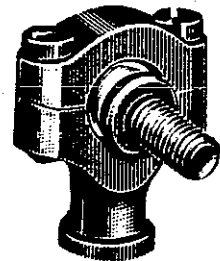

51241 D

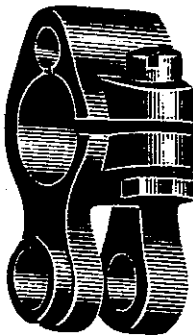

51236



51770

Specify Gauge

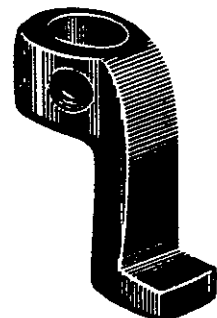

51283 C

Plate 17- Full Size



1286



1286A



51236 A



21



51293 B



51243 C



1361 A



12964 C



16676



1248



51283 B

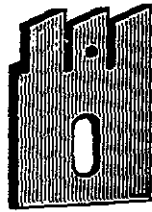

51404



51236 B

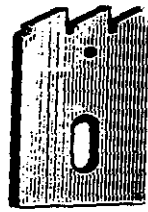

51504

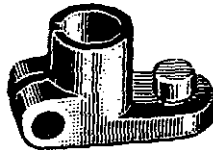

21657 B

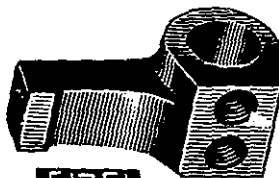

51751

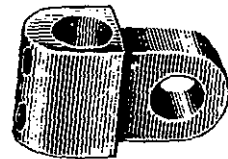

35759

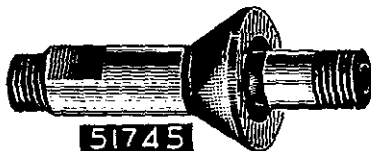

51745

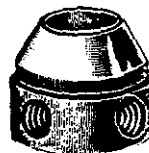

15465F

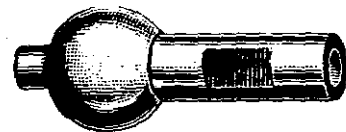

51243 B

Plate 18- One-half Size

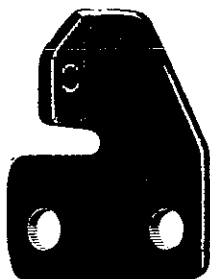

23436



23229 L

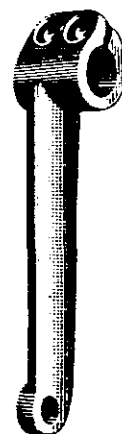

51235 A

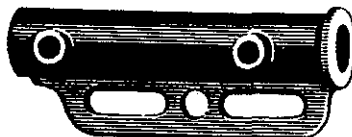

51744



23229 K

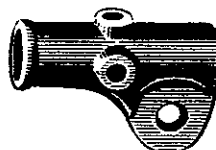

51244



51183

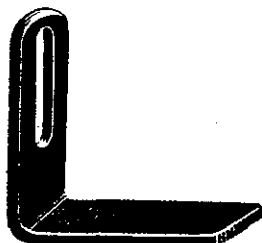

23433

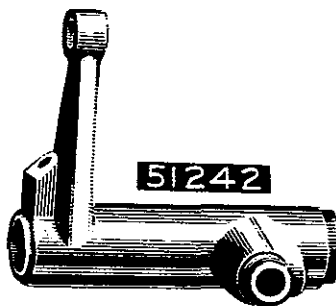

51242



23432

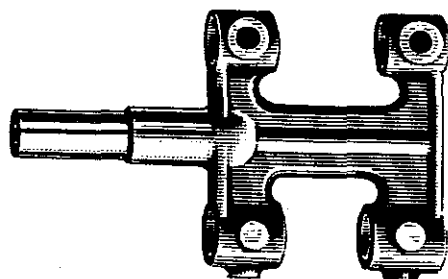

51235



51234

Plate 19- One-half Size

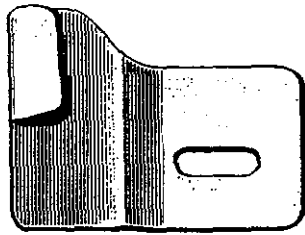

23404 E

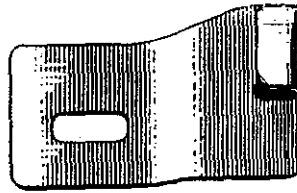

23404



23437 B

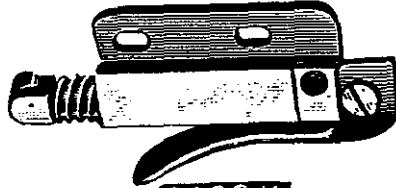

2603 K

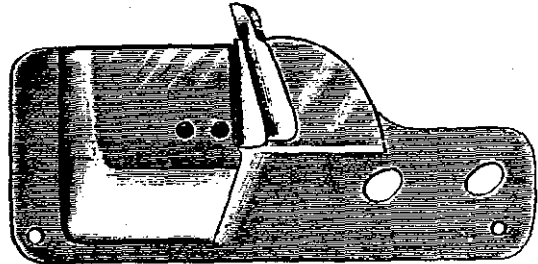

23100



23215 BC

Specify Width

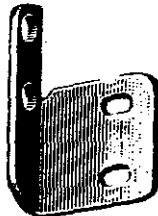

23322 AC

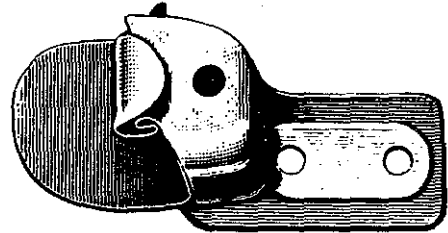

23420 U

Specify Gauge  
and Capacity

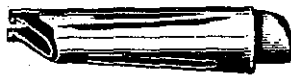

23322 AB

Specify Width



23437 A

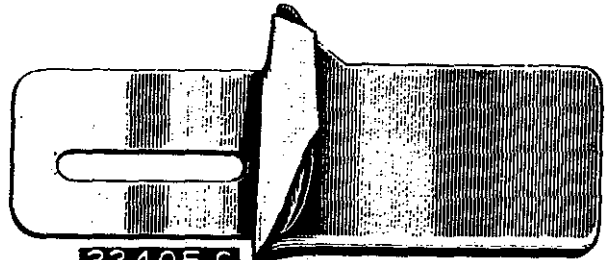

23405 G

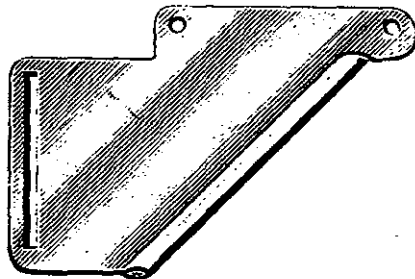

23403

Specify Gauge

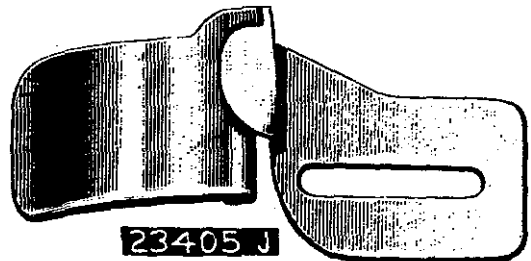

23405 J

Plate 20- One-half Size

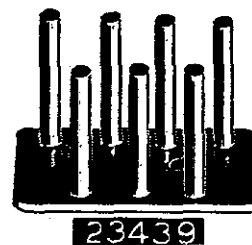
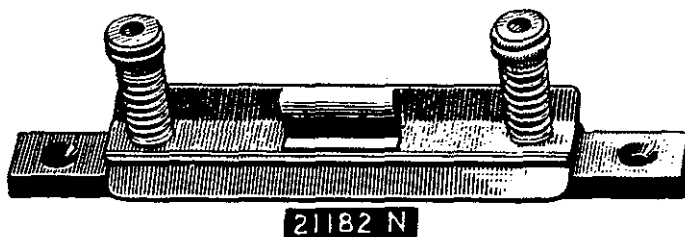
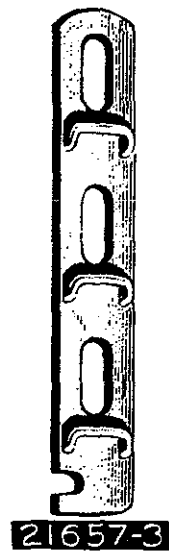
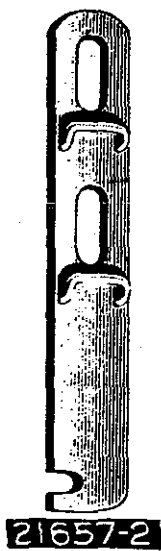
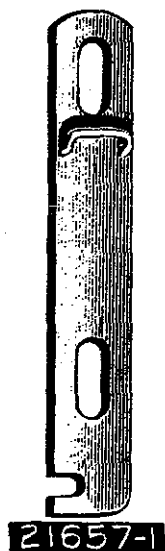
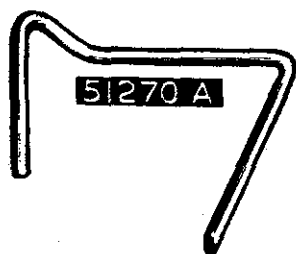
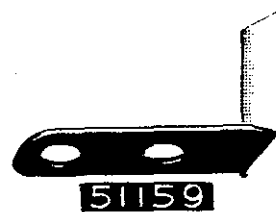
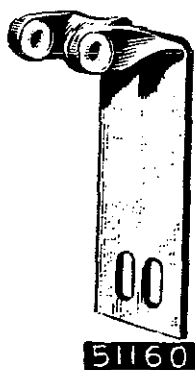
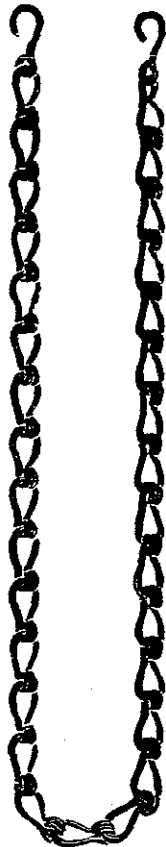

Plate 21- One-half Size



421



21388 N

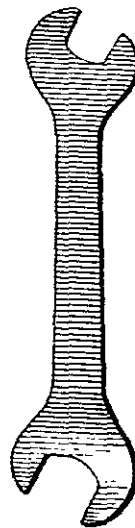

21388 R



21388

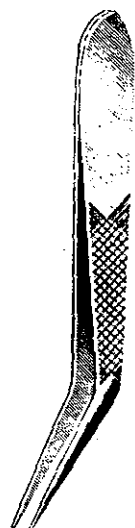

118 B



116



53



51252



54

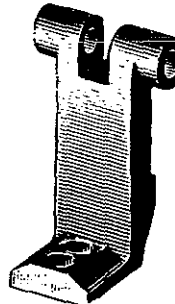

51462

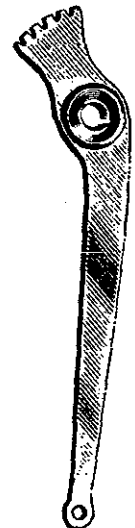

51251

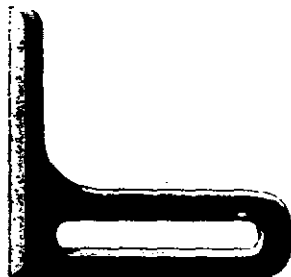

24



2L X

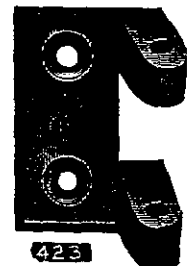

423

Plate 22- One-half Size

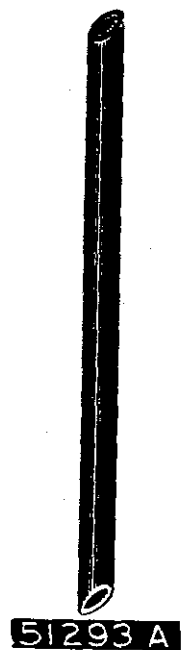
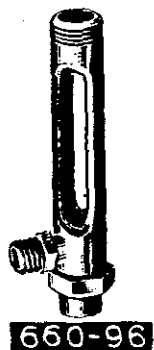
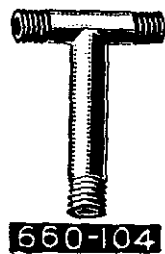
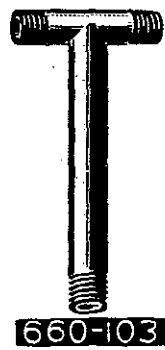
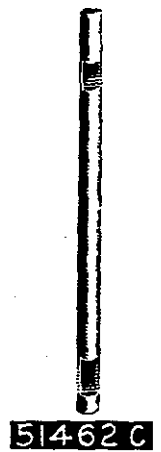
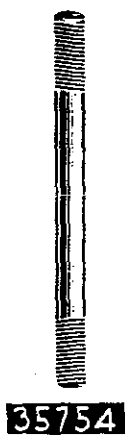
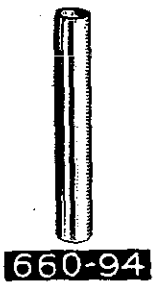
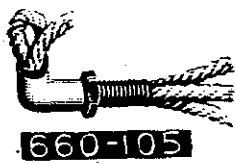

Plate 23- One-half Size

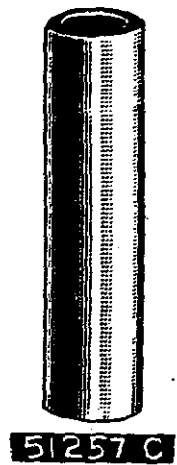
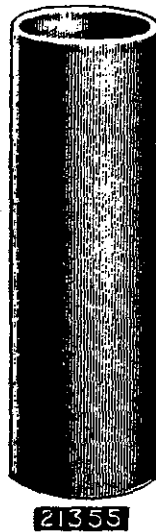
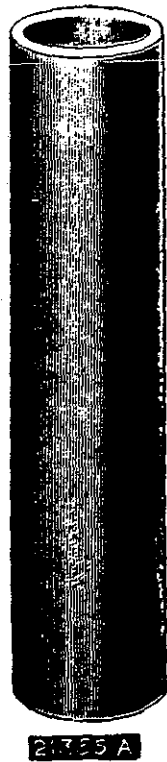
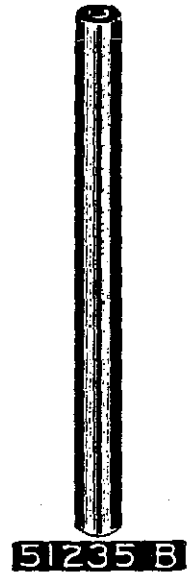
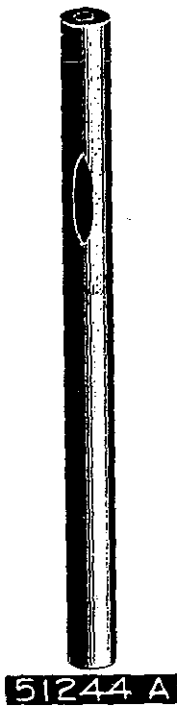
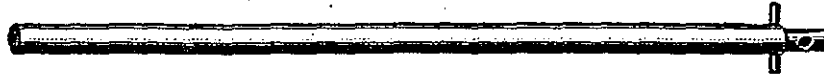



Plate 24- One-half Size



51917-9



51917-5

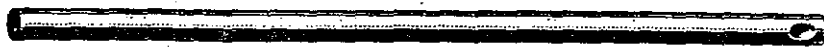

51717



51517A



51517-16



51417B

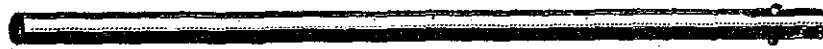

51417

Specify Gauge



51217

Plate 25- One-half Size

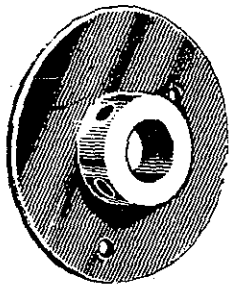

51461 A

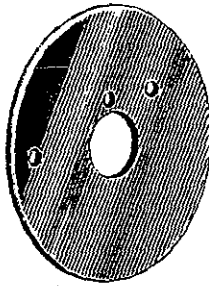

51461

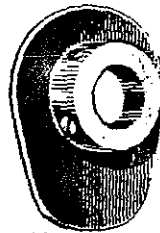

51123



51423

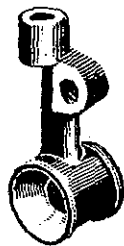

51213

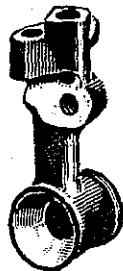

51413



51513

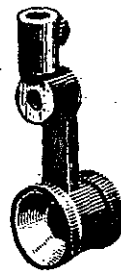

51713

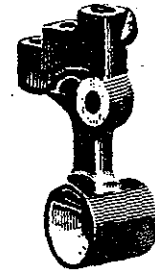

51913

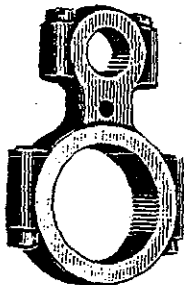

51243 A



51216 A

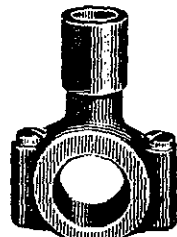

51216 B



51772

Specify Gauge



51241

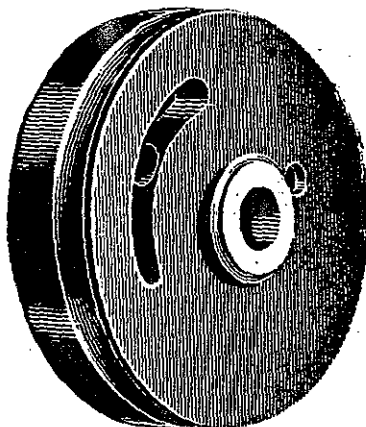

51321

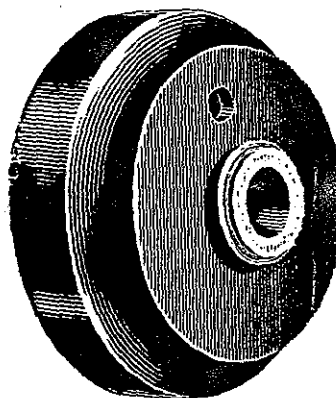

51321 A

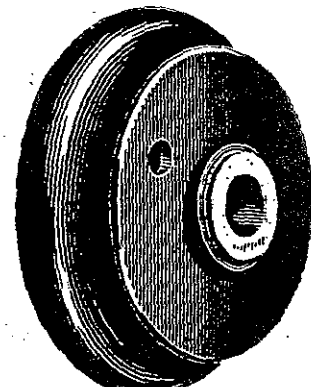

51221

Plate 26- One-half Size

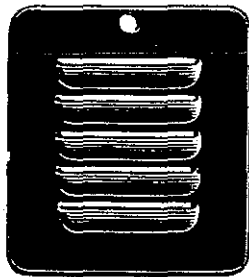

51282

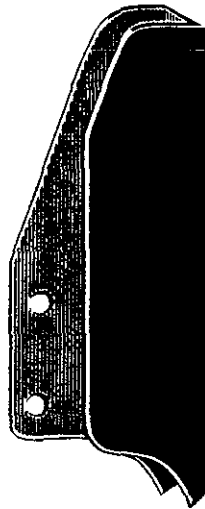

51291

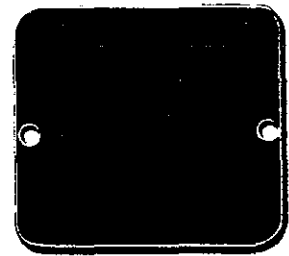

51282 A

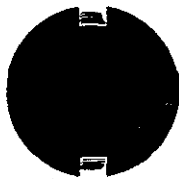

51101 Q

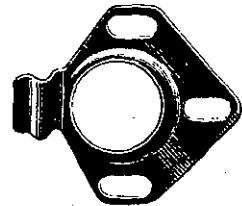

51281 F



51256



51256 A



51256 B

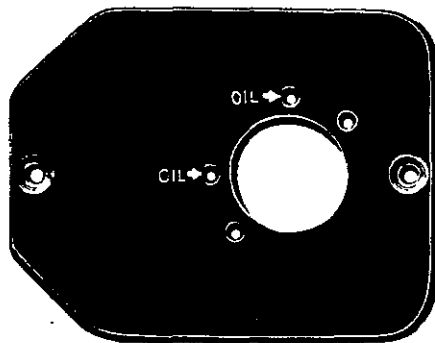

51282 C



51282 B

Plate 27- One-fourth Size

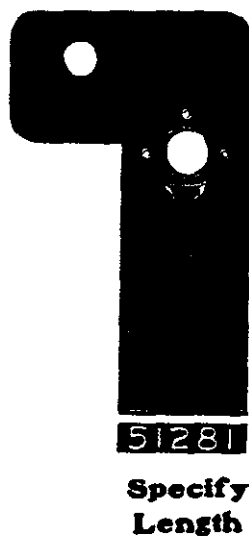
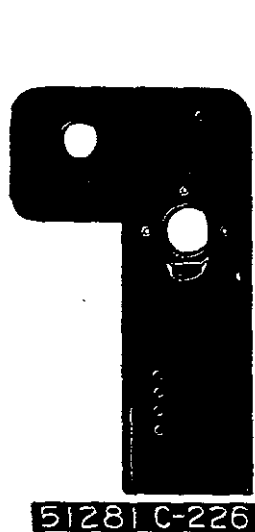
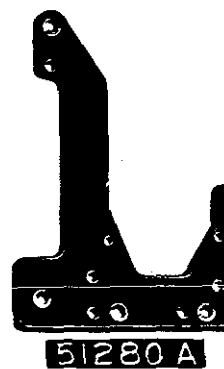
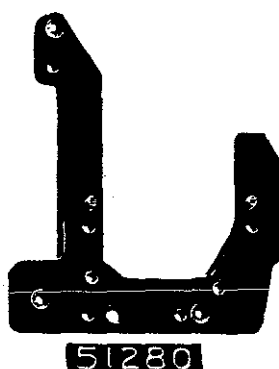
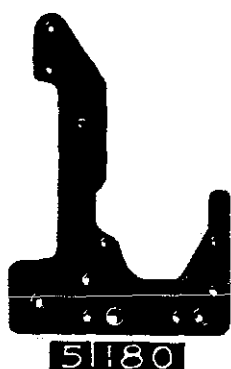
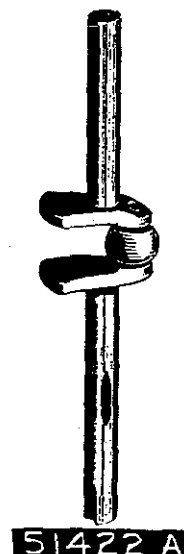
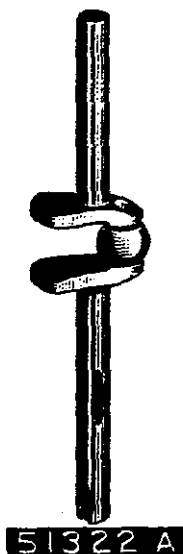
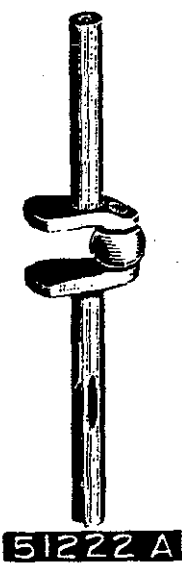
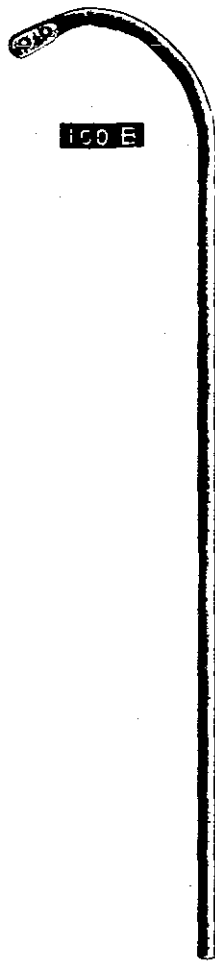

Plate 28- One-fourth Size



21104 B

Specify Length



150 E

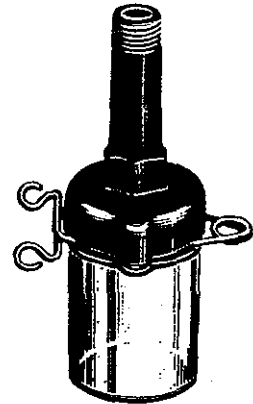

51294

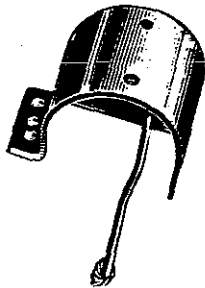

51243 J

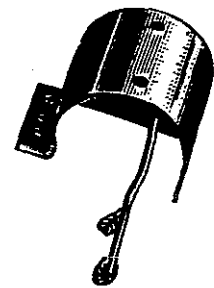

51743 A



51293



23435

Specify Gauge

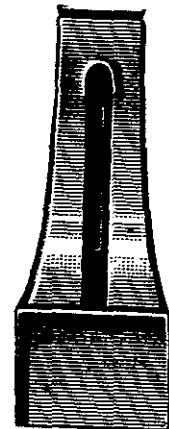

23401 H

Specify Gauge

Plate 29- One-fourth Size

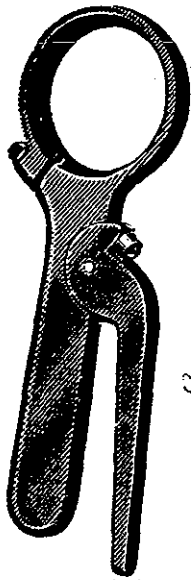

T 9396



51215 A



51222



21685

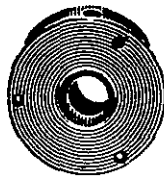

35791 A

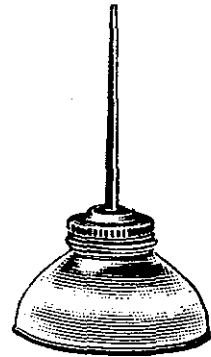

413

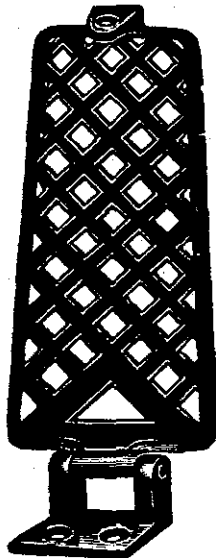

29402

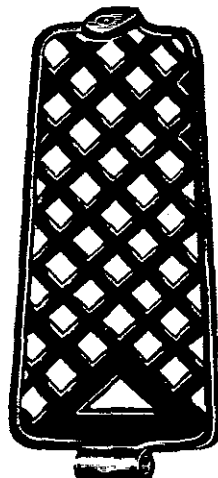

422

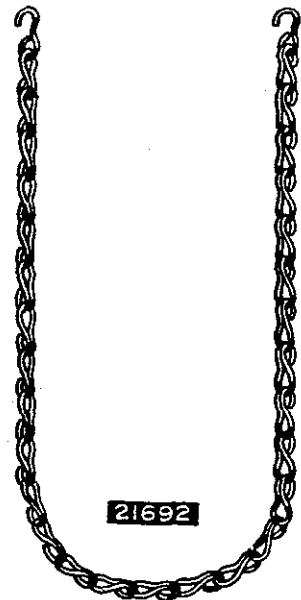

21692

Plate 30- One-fourth Size

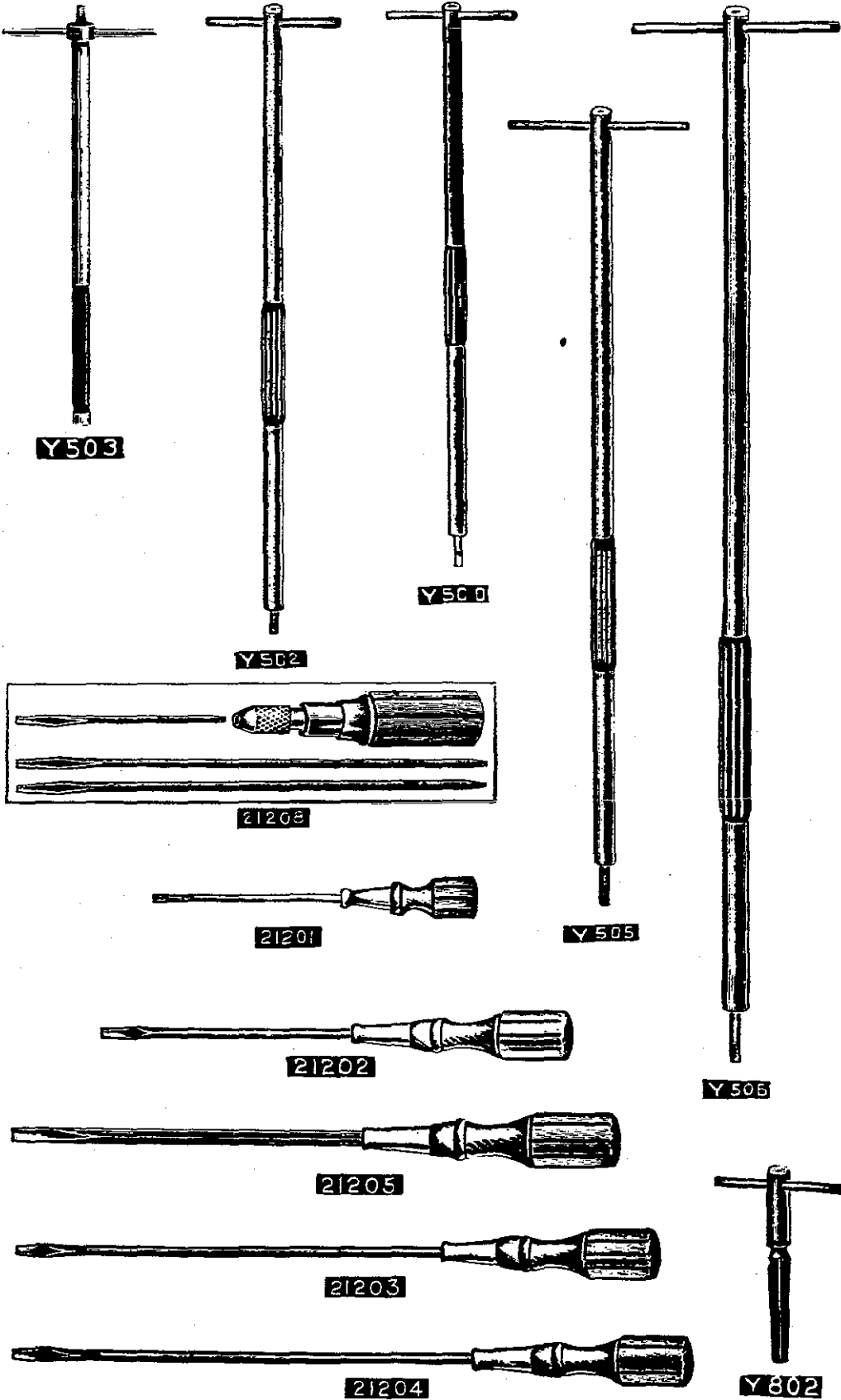

Plate 31- One-eighth Size

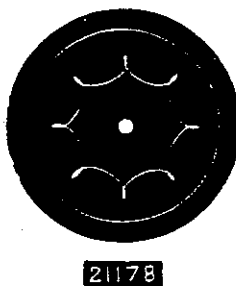
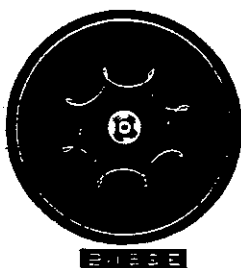
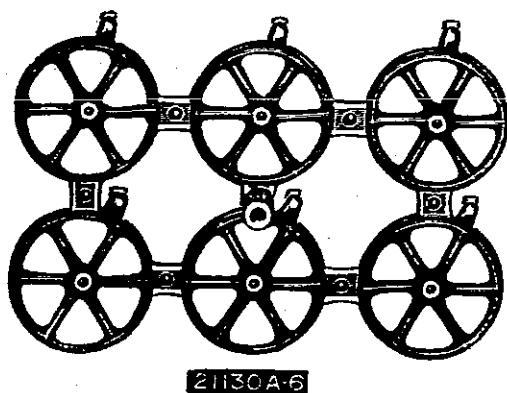
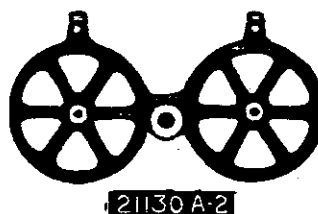
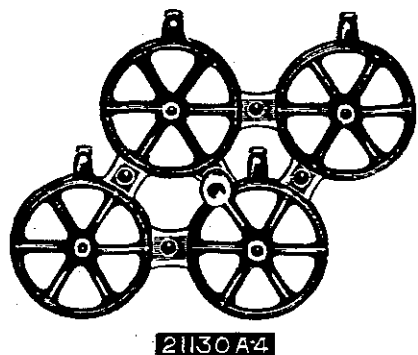
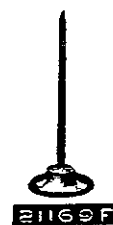
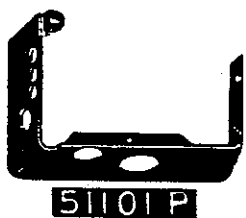
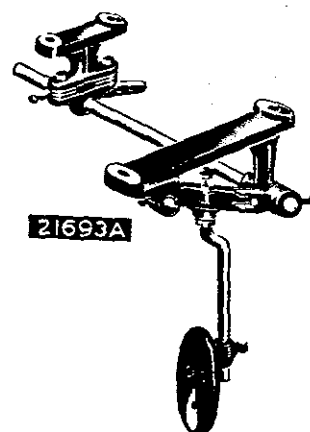
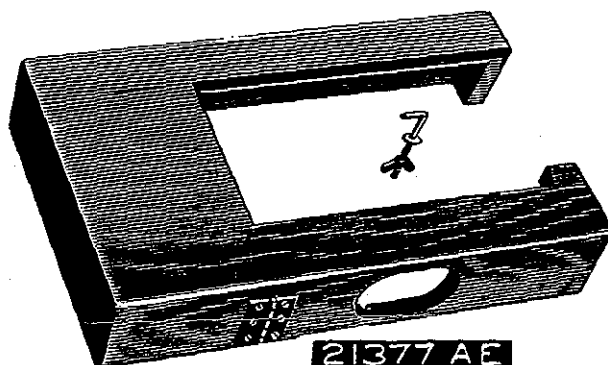
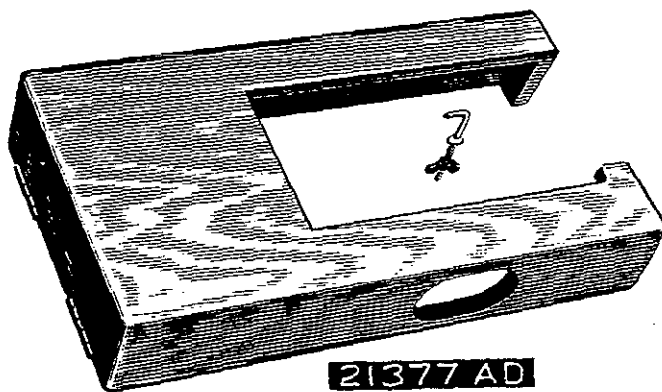
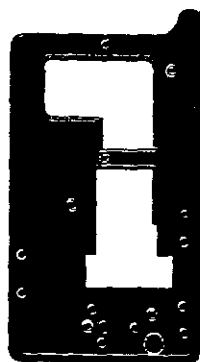



Plate 32- One-eighth Size



51101



51201



51201A



51701

LIST OF PARTS

Symbol to Order by	The figures in the last column refer only to the plates illustrating the parts and are not to be used in ordering. Refer to pink insert for prices.	Plate No.
16	Feed Crank Link Ferrule .....	15
18	Looper Connecting Rod Nut, right thread; also for No. 35754 .....	11
20	Feed Crank Stud Washer .....	11
21	Feed Crank Link Pin .....	17
22 D	Feed Dog, for Style 51200 E (screw No. 93) ...	1
22 Y	Feed Dog, for Style 51100 B (screw No. 93) ...	1
24	Edge Guide, for Style 51300 A .....	21
24 X	Edge Guide, for Styles in Class 51100; also Style 51200 C .....	21
25	Thumbscrew, for cloth plate edge guides .....	10
25 B	Screw, for angular strip guide on Styles 51400 B, 51400 C, 51700 C, 51700 D .....	9
25 C	Screw, 9/32 inch long, for cloth plate attach- ments .....	10
28	Screw, for lap seam feller upper scrolls ....	9
34	Knee Lifter Stop Screw Nut .....	11
36 G	Looper Connecting Rod Ball Stud Washer .....	11
43	Feed Lift Eccentric and Looper Avoiding Eccentric, for styles in Classes 51400, 51700; also Styles 51200 A, 51200 E, 51200 G, 51900 A (spot screw No. 96) .....	16
43 C	Feed Lift Eccentric and Looper Avoiding Eccentric, for Styles in Classes 51300, 51500; also Styles 51100 B, 51200 B, 51200 C, 51900 B (spot screw No. 96) .....	16
52 A	Frame Needle Thread Eyelet (screw No. 98 A) .	14
54	Needle Lever Link .....	21
56	Needle Clamp Nut, for styles in Classes 51100, 51200, 51300 .....	11
57 WA	Needle Bar Thread Nipper Collar, for Styles in Class 51100 (screw No. 88) .....	14
57 WB	Needle Bar Thread Nipper Plate .....	14
57 WD	Needle Bar Thread Nipper Stud .....	9
64 A	Presser Spring Regulating Screw .....	10
64 B	Presser Spring Regulating Screw Lock Nut ...	11
65 X	Presser Foot, hinged, for Styles 51100 A, 51100 C (set screw No. 88, hinge screw No. 86 X) .....	4
65 XC	Presser Foot Bottom, for Styles 51100 A, 51100 C .....	—
65 XD	Presser Foot Shank, for Styles 51100 A, 51100 C, 51300 B .....	—
69 S	Spool Pin, 4 inches long, for thread stands ..	31
<input type="checkbox"/> 69 FD	Screw, square head, cup point, 5/16 inch diam. 18 threads, 5/8 inch long, for thread stand seat; also for Nos. 21685, 21693 F, 21693 K ..	10
73	Set Screw, for loopers .....	9
75	Screw, for hand lifter plate, on styles in Class 51100 .....	9
75 A	Screw, for needle lever connecting rod bearing, lower; also for No. 51243 A .....	10
77	Set Screw, for feed crank link pin; also for Nos. 1286, 1286 A, 51420 C, 51720, 51720 D ....	9
78	Set Screw, for lower needle lever link pin ..	9
79	Screw, for take-up thread eyelets; also for No. 51462 .....	9
80	Screw, for cloth plates .....	9

LIST OF PARTS

Symbol to Order by	The figures in the last column refer only to the plates illustrating the parts and are not to be used in ordering. Refer to pink insert for prices.	Plate No.
86 X	Presser Foot Hinge Stud, for Styles 51100 A, 51100 C, 51300 B .....	9
87	Screw, countersunk head, for throat plates ...	9
87 U	Screw, for needle thread take-up wires; also for Nos. 51260, 51260 A, 51460, 51460 A, 51960, 51960 A .....	9
88	Screw, for looper rocker cone; also for Nos. 57 WA, 65 X, 161, 51283 C, 51320 B .....	9
88 A	Set Screw, for needle bars; also for No. 23432.	9
88 B	Screw, for looper rocker frame sleeves .....	9
89	Spot Screw, for take-up; also for Nos. 7018 E-5, 8118-64, 35818 N, 51418-16, 51418 B-32, 51418 B-48, 51461 A, 51918 .....	9
90	Screw, for louver cover; also for Nos. 10685, 23215 BB, 23322 AB, 23322 AC, 23439, 51170 B, 51270 A, 51282 A .....	9
91	Clamp Screw, for presser feet .....	9
91 A	Screw, for presser foot yielding spring guide on Style 51200 E .....	9
93	Screw, for feed dogs; also for Nos. 23229 L, 51235 A, 51244 B, 51759 .....	9
93 A	Screw, for feed lift eccentric oil tube clamp; also for Nos. 2603 K, 51243 G, 51959 .....	9
94	Screw, for looper lever connection guard; also for Nos. 7459 A, 23401 H, 23432, 23433, 35558 A, 51159, 51243 J, 51758 .....	9
95	Screw, for main shaft collar .....	9
96	Spot Screw, for feed lift eccentrics and looper avoiding eccentrics; also for Nos. 51242 C, 51244, 51343, 51443, 51744 .....	9
97	Screw, for needle lever ball stud guide fork; also for Nos. 51243 A, 51293 .....	9
97 A	Screw, for needle lever connecting rod bear- ing, upper; also for Nos. 51243 A, 51741, 51741 B .....	9
98	Set Screw, 3/16 inch long, without pilot, for needles; also for Nos. 482, 51235, 51244, 51343, 51433, 51443, 51744 .....	9
98 A	Screw, for frame thread eyelet No. 52 A .....	9
100 B	Thread Stand Wire, 16 inches long (set screw No. 22632 F-24) .....	28
107	Strip Tension Ferrule, for Styles 51400 D, 51700 D .....	14
108	Strip Tension Nut .....	14
109	Tension Disk .....	14
110-3	Tension Spring, .040 inch diam. wire, for tape reel axle; also for No. 21182 N .....	11
116	Wrench, for needle clamp nut .....	21
118 B	Thread Tweezers .....	21
V118	Tap, marked "X2" for No. 22521 .....	12
136	Screw, for facing strip folder bracket, on Styles 51400 B, 51400 D, 51700 D .....	10
137	Needle Thread Controller Eyelet, for styles in Classes 51200, 51300, 51400, 51500, 51900..	14
138	Needle Thread Controller Eyelet Screw .....	9
141	Screw, for needle thread controller lever ...	10
158 A	Frame Looper Thread Eyelet (screw No. 98 A) .	20
161	Collar, for binding holder disk, on Styles 51200 A, 51200 B (screw No. 88) .....	15

LIST OF PARTS

Symbol to Order by	The figures in the last column refer only to the plates illustrating the parts and are not to be used in ordering. Refer to pink insert for prices.	Plate No.
187 A	Screw, for presser foot chain knife on Style 51200 D .....	9
201 A	Tape Reel Frame, for styles in Class 51700; also Styles 51400 B, 51400 C, 51400 D .....	31
201 C	Thumbscrew, for tape reel axle .....	10
269	Looper Connecting Rod Nut, left thread; also for No. 51236 C .....	11
402	Hand Lifter Screw Pin, for styles in Class 51100 .....	9
413	Oil Can, complete .....	29
421	Foot Lifter Lever Chain, 38 inches long ....	21
422	Foot Lifter Treadle .....	29
423	Foot Lifter Treadle Base .....	21
424	Foot Lifter Treadle Pin (screw No. 22813) ...	23
482	Feed Rocker Shaft Collar (screw No. 98) .....	21
Y500-257	Expansion Reamer, for needle bar bearings, size .257 inch .....	30
Y502-319	Expansion Reamer, for upper presser bar bearing, size .319 inch .....	30
Y503-319	Expansion Reamer, for lower presser bar bearing, size .319 inch .....	30
Y505-407	Expansion Reamer, for looper rocker and feed rocker shaft bearings, size .407 inch .....	30
Y506-530	Expansion Reamer, for main shaft bearings, size .530 inch .....	30
531	Set Screw, for looper lever shaft bushing, front; also for Nos. 23229 K, 51242 A, 51252, 51751 .....	9
604	Screw, for thread controller lever connection thread guide .....	9
605 A	Screw, for needle stop plate, on styles in Class 51700 .....	9
<input type="checkbox"/> 650-10	Stove Bolt, flat head, 1/4 x 1 1/4 inches ....	—
<input type="checkbox"/> 650-24	Stove Bolt, flat head, 1/4 x 3 inches .....	—
<input type="checkbox"/> 650-28	Stove Bolt, flat head, 1/4 x 3 1/2 inches ....	—
660-74	Connection Sleeve, for oil line to main bearings .....	12
660-75	Connection Sleeve Coupling .....	12
660-84	Tube, left, for oil line to main shaft bearings .....	22
660-85	Tube, middle .....	22
660-86	Tube, right .....	22
660-90	Felt Wiper, for looper lever eccentric connection .....	12
660-92	Leather Washer, upper, for main shaft oil gauge .....	11
660-93	Leather Washer, lower .....	12
660-94	Glass Tube, for main shaft oil gauge .....	22
660-95	Cap, for main shaft oil gauge .....	12
660-96	Frame, for main shaft oil gauge .....	22
660-103	Oil Line "T" Coupling, for middle main shaft bearing .....	22
660-104	Oil Line "T" Coupling, for inner right main shaft bearing .....	22
660-105	Oiling Tube, for feed crank link .....	22
660-107	Oil Line Coupling, for left main shaft bearing .....	12
666-13	Felt Wick, spring pressed, for main shaft bearings .....	12
666-16	Reservoir, for oil drain assembly .....	—

See Page 8.

LIST OF PARTS

Symbol to Order by	The figures in the last column refer only to the plates illustrating the parts and are not to be used in ordering. Refer to pink insert for prices.	Plate No.
666-19	Felt Wick,for needle lever connecting rod lower bearing;also for Nos.51236,51245 ...	12
666-20	Felt Wick,for looper avoiding eccentric link	12
666-28	Oil Cup,for needle lever stud .....	12
666-29	Felt Wick,for needle lever stud .....	22
666-42	Coupling, "L" type,for outer right main shaft bearing .....	12
719	Set Screw,for needle lever stud;also for No.51250 B .....	9
Y802	Taper Reamer,for needle lever link and feed crank link pins .....	30
1248	Feed Crank Link Shim,leather;also for No. 51245 .....	17
1280	Looper Rocker Stud Nut,for styles in Class 51700 .....	11
1286	Needle Lever Link Pin Assembly;one each Nos.1286 A,1286 B,12964 C,22560 .....	17
1286 A	Needle Lever Link Pin (set screw for upper link pin No.77,set screw for lower link pin No.78) .....	17
1286 B	Needle Lever Link Pin Spring (screw No. 22560) .....	11
1290	Needle Bar Thread Nipper Spring,for styles in Class 51100 .....	11
1346	Strip Tension Post,for Styles 51400 D, 51700 D .....	14
1347	Tension Post Ferrule,for strip tension on Styles 51400 D,51700 D .....	14
1361 A	Presser Spring Pin .....	17
1727 A	Presser Foot,hinged bottom,for Style 51200 D (clamp screw No. 91) .....	3
1741 B	Presser Foot Chain Knife,for Style 51200 D (screw No.187 A) .....	4
1805 A	Feed Dog,for Styles 51100 A,51100 C (screw No.93) .....	1
2603 K	Edge Guide Assembly,for Style 51200 D; one each Nos.14775 A,16675,16676,22768,22772 (screw No.93 A) .....	19
6224 B	Throat Plate,for Style 51200 E (screw No.87) .....	7
6235	Yielding Spring Guide for presser foot on Style 51200 E (screw No.91 A) .....	4
6405 M	Feed Dog,for Style 51200 B (screw No.93) ...	1
6405 W	Feed Dog,for Style 51200 C (screw No.93) ...	1
6420 W	Presser Foot,hinged bottom,for Styles 51200 B,51200 C (clamp screw No.91) .....	4
6424 W	Throat Plate,for Style 51200 C (screw No.87).	7
6520	Presser Foot,hinged bottom,for Style 51300 A (clamp screw No.91) .....	3
7018 E-5	Needle Holder,for No.18 gauge Style 51500 A (spot screw No.89,needle set screw No.98).	14
7459 A	Take-up Thread Eyelet Spring,for styles in Classes 51200,51300,51400,51500,51700, 51900 (screw No.94) .....	12
7933-48	Needle Stop Plate,for Nos.56 and 64 gauge styles in Class 51700 (screws No.605 A)...	14
7947	Feed Crank Link Nut;also for No.51245 .....	11

LIST OF PARTS

Symbol to Order by	The figures in the last column refer only to the plates illustrating the parts and are not to be used in ordering. Refer to pink insert for prices.	Plate No.
8118-64	Needle Holder, for No. 64 gauge styles in Class 51700 (spot screw No. 89, needle set screw No. 98) .....	14
9224 E	Throat Plate, for Style 51300 A (screw No. 87)	7
9255	Facing Strip Folder Washer, on Styles 51400 B, 51400 D, 51700 D; also for No. 23436 .....	11
T9396	Wrench, for main shaft bearing housing .....	29
9705	Feed Dog, for Style 51200 G (screw No. 93) ...	1
9720	Presser Foot, for Style 51200 G (clamp screw No. 91) .....	4
9724	Throat Plate, for Style 51200 G (screw No. 87)	7
10685	Throat Plate Support Thread Eyelet, for Styles in Class 51100 (screw No. 90) .....	20
12538	Looper Rocker Ball Stud Nut, for styles in Classes 51100, 51200, 51300, 51400, 51500, 51900 .....	11
12935 A	Screw, for adjusting presser foot bottom on Style 51900 A .....	9
12957 E	Spring Washer, for folder swinging arm on styles in Class 51700 and Styles 51400 B, 51400 C; also for No. 23437 A .....	11
12964 C	Needle Lever Link Pin Ball .....	17
12987 A	Looper Rocker Cone Nut .....	11
12993 A	Stop Screw, for knee lifter interlocking arm; also for No. 21693 K .....	10
14077	Looper Rocker Ball Stud Nut, for styles in Class 51700; also for No. 22835 .....	11
14775 A	Edge Guide Spring, for Style 51200 D .....	—
15430 C	Needle Lever Connecting Rod Nut, left thread,	11
15430 D	Needle Lever Connecting Rod Nut, right thread; also for No. 21693 J .....	11
15465 F	Looper Rocker Cone (screw No. 88, nut No. 12987 A) .....	17
16152-56	Needle Holder, for No. 56 gauge Style 51700 C (spot screw No. 89, needle set screw No. 98).	14
16164	Tension Post Ferrule, for styles in Class 51100 .....	11
16675	Edge Guide Roller, for Style 51200 D .....	15
16676	Edge Guide Roller Pin .....	17
21104 A	Thread Stand Base (screw No. 22509) .....	32
21104 B-11	Thread Stand Rod, 11 inches long .....	28
21130 A-2	Thread Stand Seat, 2 spools .....	31
21130 A-4	Thread Stand Seat, 4 spools .....	31
21130 A-6	Thread Stand Seat, 6 spools .....	31
	Thread Stand Seat Set Screw No. 69 FD	
21169 E	Binding Holder Disk, for Styles 51200 A, 51200 B .....	31
21169 F	Binding Holder Base .....	31
21178	Tape Reel Disk, 8 inches diam. for styles in Class 51700; also Styles 51400 B, 51400 C, 51400 D .....	31
21182 K	Strip Tension Plate, outer, for Styles 51400 D, 51700 D .....	—
21182 L	Strip Tension Plate, inner .....	—
21182 N	Strip Tension Assembly, for Styles 51400 D, 51700 D; one each Nos. 21182 K, 21182 L, 21182 P, and two each Nos. 107, 108, 110-3, 1346, 1347 .....	20
21182 P	Strip Tension Base .....	—

LIST OF PARTS

Symbol to Order by	The figures in the last column refer only to the plates illustrating the parts and are not to be used in ordering. Refer to pink insert for prices.	Plate No.
21201	Screw Driver, 9/64 inch round blade, length overall 7 5/8 inches .....	30
21202	Screw Driver, 7/32 inch round blade, length overall 11 inches .....	30
21203	Screw Driver, 7/32 inch round blade, length overall 15 inches .....	30
21204	Screw Driver, 1/4 inch round blade, length overall 15 inches .....	30
21205	Screw Driver, 3/8 inch octagon blade, length overall 14 inches .....	30
21208	Screw Driver Set, three detachable blades ...	30
21210	Looper Collar, .040 inch thick .....	11
21210 A	Looper Collar, .020 inch thick .....	—
21211	Looper Collar, .054 inch thick .....	11
21225-1/8	Looper Adjusting Gauge, 1/8 inch measurement.	12
21225-5/32	Looper Adjusting Gauge, 5/32 inch measurement	12
21225 A	Looper Gauge, universal adjustment .....	12
21261	Leather Belt, flat, 1 inch wide, 63 inches long, includes belt fastener No. 21350 .....	—
21262	Leather Belt, round, 9/32 inch diameter, 44 inches long, includes wire belt hook No. 21351 .....	—
21350	Belt Fastener, malleable iron, for 1 inch flat belt .....	12
21351	Belt Hook, wire, for 9/32 inch round belt ....	12
21355	Chair Leg Extension, 4 inches long .....	23
21355 A	Chair Leg Extension, 6 inches long .....	23
□ 21368	Washer, 1/4 inch, for flat head stove bolts...	—
21371 B	Table Top, 48 inches long, 16 1/8 inches wide, 1 3/4 inches thick .....	—
21371 M	Individual Power Table, blank top, without electric transmitter or electric fittings	—
21371 AN-12	Individual Power Table, equipped with 3000 R.P.M. 1/2 H.P. 115 volt, D.C. transmitter (specify diam. of transmitter pulley).....	—
21371 AN-13	Individual Power Table, equipped with 3000 R.P.M. 1/2 H.P. 230 volt, D.C. transmitter..	—
21371 AP-15	Individual Power Table, equipped with 3450 R.P.M. 1/2 H.P. 220 volt, 3 phase, 60 cycle, A.C. transmitter (specify diam. of transmitter pulley) .....	—
21371 AQ-17	Individual Power Table, equipped with 3300 R.P.M. 1/2 H.P., 110 volt, single phase, 60 cycle, A.C. transmitter (specify diam. of transmitter pulley) .....	—
21371 AQ-18	Individual Power Table, equipped with 3300 R.P.M. 1/2 H.P. 220 volt, single phase, 60 cycle, A.C. transmitter .....	—
21375 AA	Pulley Oil Guard, for styles in Classes 51200, 51300, 51400, 51500, 51700, 51900 .....	31
21377 AD	Tray, hinged, for machines without attachments that overhang front of cloth plate .....	32
21377 AE	Tray, hinged, for machines with attachments that overhang front of cloth plate .....	32
21377 AF	Tray, hinged, for machines which are installed below surface of table and which do not have attachments overhanging front of cloth plate .....	—
21385 B	Tape Reel Axle (screw No. 201 C) .....	31

□ See Page 8.

LIST OF PARTS

Symbol to Order by	The figures in the last column refer only to the plates illustrating the parts and are not to be used in ordering. Refer to pink insert for prices.	Plate No.
21388	Wrench, for 3/8 inch hexagon nuts .....	21
21388 N	Wrench, double end, 3/16 and 5/16 inch openings .....	21
21388 R	Wrench, double end, 3/8 and 1/2 inch openings .....	21
21394	Utility Grinder, including emery wheel 5 inches diam, 1/4 inch face, round belt drive, recommended speed 3000 R.P.M. ....	—
<input type="checkbox"/> 21394 G	Emery Wheel, 5 inches diam. 1/4 inch face, 3/8 inch hole, grade "M", emery 60 .....	—
<input type="checkbox"/> 21394 H	Emery Wheel, 5 inches diam. 1/2 inch face, 3/8 inch hole, grade "M", emery 60 .....	—
21394 K	Utility Grinder, including emery wheel 5 inches diam. 1/2 inch face, round belt drive, recommended speed 3000 R.P.M. ....	—
21657-1	Tension Release Disk Separator, for styles in Classes 51200, 51300 .....	20
21657-2	Tension Release Disk Separator, for styles in Classes 51400, 51500, 51700 .....	20
21657-3	Tension Release Disk Separator, for styles in Class 51900 .....	20
21657 A	Tension Release Rock Shaft, for styles in Classes 51200, 51300, 51400, 51500, 51700, 51900 .....	23
21657 B	Tension Release Rock Shaft Connection (clamp screw No. 22585) .....	17
21657 C	Tension Release Rock Shaft Lever (clamp screw No. 22596, stud No. 22594) .....	20
21657 D	Tension Release Rock Shaft Lever Link (stud No. 22515) .....	20
21657 E	Tension Release Disk Separator Washer, for styles in Classes 51200, 51300 .....	11
21685	Knee Lifter Plate (set screw No. 69 FD) .....	29
21692	Knee Lifter Chain, 18 1/2 inches long .....	29
21693 A	Knee Lifter Assembly; includes one each Nos. 15430 D, 21685, 21693 B, 21693 C, 21693 D, 21693 F, 21693 G, 21693 H, 21693 J, 21693 K, 21693 T, 22622; two each Nos. 34, 650-10, 12993 A; three No. 69 FD and four No. 28577 .	32
21693 B	Knee Lifter Shaft .....	—
21693 C	Knee Lifter Frame .....	—
21693 D	Knee Lifter Shaft Hanger, rear, lower section (bolt No. 650-10, compensating washer No. 28577) .....	—
21693 F	Knee Lifter Interlocking Forked Arm (set screw No. 69 FD) .....	—
21693 G	Knee Lifter Interlocking Arm, with engaging pin (set screw No. 22622, stop screw No. 12993 A, lock nut No. 34) .....	—
21693 H	Knee Lifter Interlocking Arm Pivot Pin, 1 5/8 inches long .....	—
21693 J	Knee Lifter Plate Rod (lock nut No. 15430 D) .....	—
21693 K	Knee Lifter Chain Arm (set screw No. 69 FD, stop screw No. 12993 A, lock nut No. 34) .....	—
21693 T	Knee Lifter Shaft Hanger, rear, upper section. ....	—
21756 G	Screw Pin, for oil drain assembly .....	9
22504 A	Stud, for folder swinging arm, on styles in Class 51700; also Styles 51400 B, 51400 C...	10



LIST OF PARTS

Symbol to Order by	The figures in the last column refer only to the plates illustrating the parts and are not to be used in ordering. Refer to pink insert for prices.	Plate No.
<input type="checkbox"/> 22509	Set Screw, square head, cup point, 5/16 inch diam. 18 threads, 1/2 inch long, for thread stand base .....	10
22513	Screw, for presser bar connection guide plate	9
22514	Screw, 7/16 inch long, for cloth plate attachments .....	10
22515	Stud, for tension release rock shaft lever link .....	9
22519	Set Screw, hexagon head, for needle lever ball stud .....	9
22521	Screw, plus size, for cloth plates, tap No. V118	9
22524	Screw, for upper crank chamber cover .....	9
22525	Screw, .010 inch plus size, length overall 5/16 inch; otherwise same as No. 87 .....	9
22539 C	Plug Screw, for cloth plates .....	10
22548	Screw, for facing strip folder .....	10
22560	Screw, for needle lever link pin spring .....	9
22560 B	Screw, for feed bar; also for No. 51462 B .....	9
22566 A	Stud, for lifter lever .....	10
22569	Screw, for feed crank link; also for Nos. 35791 A, 51245 .....	9
22570	Screw, fillister head, for throat plates .....	9
22571 A	Plug Screw, for main shaft oil reservoir .....	10
22580	Set Screw, 9/64 inch long, for outer needles on Style 51900 B .....	9
22585	Clamp Screw, for tension release rock shaft connection; also for No. 23437 B .....	9
22585 B	Screw, for needle guards .....	10
22591	Set Screw, for looper lever ball stud .....	9
22594	Stud, for tension release rock shaft lever ..	9
22596	Clamp Screw, for tension release rock shaft lever .....	10
22597	Spot Screw, for pulleys .....	9
22597 A	Set Screw, for pulleys .....	10
22598 C	Stud, for tension release disk separator on styles in Classes 51200, 51300 .....	10
22622	Set Screw, for knee lifter interlocking arm .	9
<input type="checkbox"/> 22632 F-24	Screw, square head, cup point, 3/16 inch diam. 3/8 inch long, 24 threads to inch, for thread stand wires .....	9
22711	Screw, for looper thread guard .....	10
22726 A	Screw, for cloth plate cover spring .....	9
22730	Screw, for frame needle thread guide No. 51758 A on styles in Class 51700 .....	10
22733 A	Plug Screw, for presser bar bearing .....	10
22735	Screw, for binder bracket on Style 51200 B ..	10
22752	Set Screw, with pilot, for middle needle on Nos. 8 and 9 gauge Style 51900 B .....	9
22752 A	Set Screw, with pilot, for middle needle on Nos. 5, 6 and 7 gauge styles in Class 51900.	9
22752 B	Screw, for adjusting presser foot bottom on styles in Classes 51400, 51700 .....	10
22757	Screw, for looper rocker link on styles in Class 51700 .....	9
22764 A	Spot Screw, for take-up .....	9
22768	Screw, for needle bar and needle lever thread eyelets; also for Nos. 2603 K, 51236 B .....	9
22769	Screw, for crank chamber oil tube clamp .....	9

See Page 8.

LIST OF PARTS

Symbol to Order by	The figures in the last column refer only to the plates illustrating the parts and are not to be used in ordering. Refer to pink insert for prices.	Plate No.
22772	Lever Stud,for edge guide assembly on Style 51200 D .....	—
22774	Thumbscrew,for folder swinging arm on styles in Class 51700;also Styles 51400 B, 51400 C .....	10
22794 B	Screw,for "Parallel Take-up" flange .....	10
22795	Stitch Regulating Screw .....	10
22799 B	Hinge Screw,length overall 37/64 inch, diam..088 inch,for presser foot on Style 51400 A .....	10
22799 C	Hinge Screw,length overall 49/64 inch, diam..088 inch, for presser foot on Styles 51500 A,51900 B .....	10
22799 D	Hinge Screw,length overall 49/64 inch, diam. .124 inch,for presser foot on Styles 51400 B,51400 C,51400 D,51700 C,51700 D ..	10
22799 E	Hinge Screw,length overall 41/64 inch,diam. .088 inch,for presser foot on Style 51900 A .....	10
22799 G	Hinge Screw,length overall 25/64 inch,diam. .088 inch,for presser foot on Style 51200 E .....	9
22801	Stop Screw,for stitch regulating screw .....	9
22813	Screw,headless,for foot lifter treadle pin..	9
22825	Screw,for cloth plate apron .....	9
22829	Locking Screw,for looper rocker cone nut ...	10
22833	Screw,for "Parallel Take-up" cast off .....	10
22834	Screw,for adjusting needle guard .....	9
22835	Stud,for looper rocker link .....	10
22837	Thumbscrew,for face plate .....	10
22839	Screw,for throat plate support .....	10
22840	Adapter Screw,for frame needle thread eyelet, on styles in Classes 51100,51700 .....	10
22850	Hand Lifter Stud,for styles in Class 51100 .	10
23100	Folder and Guide,3/64 inch capacity,3/16 inch overlap,for Style 51200 G (screw No.25 C) .....	19
23215 BC-5/8	Binder,for selvage edge and prefolded binding 5/8 inch wide,5/32 inch capacity for body fabric, on Style 51200 B .....	19
23215 BC-3/4	Binder,for selvage edge and prefolded binding 3/4 inch wide .....	19
23215 BC-7/8	Binder,for selvage edge and prefolded binding 7/8 inch wide .....	19
23229 K	Binder Screw No. 90. Folder Swinging Arm,for styles in Class 51700;also Styles 51400 B,51400 C (stop screw No.531,pivot stud No.22504 A, thumbscrew No.22774) .....	18
23229 L	Folder Swinging Arm Support (screw No.93) ..	18
23322 AB-3/4	Binder,for cut edge binding 3/4 inch wide, finishes 7/32 inch,1/8 inch capacity for body fabric,on Style 51200 A .....	19
23322 AB-7/8	Binder,for cut edge binding 7/8 inch wide, finishes 1/4 inch,1/8 inch capacity for body fabric .....	19
23322 AB-1	Binder,for cut edge binding 1 inch wide, finishes 9/32 inch,1/8 inch capacity for body fabric.....	19

LIST OF PARTS

Symbol to Order by	The figures in the last column refer only to the plates illustrating the parts and are not to be used in ordering. Refer to pink insert for prices.	Plate No.
23322 AB-1 1/8	Binder, for cut edge binding 1 1/8 inches wide, finishes 11/32 inch, 5/32 inch capac- ity for body fabric .....	19
23322 AB-1 1/4	Binder, for cut edge binding 1 1/4 inches wide, finishes 13/32 inch, 5/32 inch capac- ity for body fabric .....	19
23322 AC	Binder Screw No.90.	
23401 H-48	Binder Support (screw No.90) .....	19
23401 H-56	Folder, for center plait, 1/32 inch capacity, uses 2 1/4 inch plait strip, 1 1/4 inch interlining strip, finishes 1 1/4 inches, on No.48 gauge Styles 51400 B, 51400 C ....	28
23401 H-64	Folder, for center plait, 1/32 inch capacity, uses 2 3/8 inch plait strip, 1 3/8 inch interlining strip, finishes 1 3/8 inches, on No.56 gauge Style 51700 C .....	28
23403-48	Folder, for center plait, 1/32 inch capacity, uses 2 1/2 inch plait strip, 1 1/2 inch interlining strip, finishes 1 1/2 inches, on No.64 gauge Styles 51700 C, 51700 D ....	28
23403-48	Folder Screw No.94.	
23403-56	Angular Strip Guide, reversible, for No.48 gauge Styles 51400 B, 51400 C .....	19
23403-56	Angular Strip Guide, reversible, for No.56 gauge Style 51700 C .....	19
23403-64	Angular Strip Guide, reversible, for No.64 gauge Styles 51700 C, 51700 D .....	19
23404	Angular Strip Guide Screw No.25 B.	
23404 E	Edge Guide, for body of garment, on Style 51700 D (screw No.25 C) .....	19
23404 E	Edge Guide, for body of garment, on Style 51400 B (screw No.25 C) .....	19
23405 G	Folder, for turning body of garment upwardly, 1/32 inch capacity, 5/16 inch fold, on Styles 51400 C, 51700 C (screw No.25 C) ...	19
23405 J	Folder, for turning body of garment down- wardly, 1/32 inch capacity, 5/16 inch fold, on Style 51400 D (screw No.25 C) .....	19
23420 U-8-1/32	Lap Seam Feller Assembly, 1/32 inch capacity, for No.8 gauge Style 51400 A; one each Nos. 23422 U-1/32, 28, 23421 U-8-1/32, 23425 U.	
23420 U-8-1/32	Specify component parts in ordering .....	19
23420 U-8-1/16	Lap Seam Feller Assembly, 1/16 inch capacity, for No.8 gauge Style 51400 A; one each Nos. 23422 U-1/16, 28, 23421 U-8-1/16, 23425 U.	
23420 U-8-1/16	Specify component parts in ordering .....	19
23420 U-10-1/32	Lap Seam Feller Assembly, 1/32 inch capacity, for No.10 gauge, two needle machines, and No.5 gauge three needle machines; one each Nos. 23422 U-1/32, 28, 23421 U-10-1/32, 23425 U. Specify component parts in order- ing .....	19
23420 U-10-1/32	Specify component parts in ordering .....	19
23420 U-10-1/16	Lap Seam Feller Assembly, 1/16 inch capacity; one each Nos. 23422 U-1/16, 28, 23421 U-10-1/16, 23425 U. Specify component parts in ordering .....	19
23420 U-10-1/16	Specify component parts in ordering .....	19

LIST OF PARTS

Symbol to Order by	The figures in the last column refer only to the plates illustrating the parts and are not to be used in ordering. Refer to pink insert for prices.	Plate No.
23420 U-12-1/32	Lap Seam Feller Assembly, 1/32 inch capacity, for No.12 gauge two needle machines, and No.6 gauge three needle machines; one each Nos.23422 U-1/32, 28, 23421 U-12-1/32, 23425 U. Specify component parts in ordering .....	19
23420 U-12-1/16	Lap Seam Feller Assembly, 1/16 inch capacity; one each Nos.23422 U-1/16, 28, 23421 U-12-1/16, 23425 U. Specify component parts in ordering .....	19
23420 U-16-1/16	Lap Seam Feller Assembly, 1/16 inch capacity, for No.16 gauge two needle machines and Nos.7 and 8 gauge three needle machines; one each Nos.23422 U-1/16, 28, 23421 U-16-1/16, 23425 U. Specify component parts in ordering .....	19
23420 U-16-3/32	Lap Seam Feller Assembly, 3/32 inch capacity; one each Nos.23422 U-3/32, 28, 23421 U-16-3/32, 23425 U. Specify component parts in ordering .....	19
23420 U-18-1/16	Lap Seam Feller Assembly, 1/16 inch capacity, for No.18 gauge two needle machines, and No. 9 gauge three needle machines; one each Nos.23422 U-1/16, 28, 23421 U-18-1/16, 23425 U. Specify component parts in ordering .....	19
23420 U-18-3/32	Lap Seam Feller Assembly, 3/32 inch capacity; one each Nos.23422 U-3/32, 28, 23421 U-18-3/32, 23425 U. Specify component parts in ordering .....	19
23421 U-8-1/32	Lap Seam Feller Screw No.25 C. Upper Scroll, for lap seam feller, 1/32 inch capacity, on No.8 gauge Style 51400 A .....	—
23421 U-8-1/16	Upper Scroll, for lap seam feller, 1/16 inch capacity .....	—
23421 U-10-1/32	Upper Scroll, for lap seam feller, 1/32 inch capacity, on No.10 gauge two needle ma- chines, and No.5 gauge three needle machines .....	—
23421 U-10-1/16	Upper Scroll, for lap seam feller, 1/16 inch capacity .....	—
23421 U-12-1/32	Upper Scroll, for lap seam feller, 1/32 inch capacity, on No.12 gauge two needle ma- chines and No.6 gauge three needle machines .....	—
23421 U-12-1/16	Upper Scroll, for lap seam feller, 1/16 inch capacity .....	—
23421 U-16-1/16	Upper Scroll, for lap seam feller, 1/16 inch capacity, on No.16 gauge two needle ma- chines and Nos.7 and 8 gauge three needle machines .....	—
23421 U-16-3/32	Upper Scroll, for lap seam feller, 3/32 inch capacity .....	—
23421 U-18-1/16	Upper Scroll, for lap seam feller, 1/16 inch capacity, on No.18 gauge two needle ma- chines and No.9 gauge three needle machines	—
23421 U-18-3/32	Upper Scroll, for lap seam feller, 3/32 inch capacity .....	—
	Upper Scroll Screw No. 28.	—

LIST OF PARTS

Symbol to Order by	The figures in the last column refer only to the plates illustrating the parts and are not to be used in ordering. Refer to pink insert for prices.	Plate No.
23422 U-1/32	Lower Scroll and Base,for lap seam feller, 1/32 inch capacity .....	—
23422 U-1/16	Lower Scroll and Base,for lap seam feller, 1/16 inch capacity .....	—
23422 U-3/32	Lower Scroll and Base,for lap seam feller, 3/32 inch capacity .....	—
23425 T	Lower Scroll Screw No.25 C. Washer Plate,for binders on Styles 51200 A, 51200 B .....	12
23425 U	Washer Plate,for cloth plate attachments ...	—
23432	Center Plait Folder Clamp,for Styles 51400 B,51400 C,51700 C,51700 D (set screw No.88 A,clamp screw No.94) ....	18
23433	Center Plait Folder Bracket (screw No.94) ..	18
23435-32	Facing Strip Folder,1/32 inch capacity,uses 1 inch strip, finishes 5/8 inch,for No.32 gauge Style 51400 D .....	28
23435-48	Facing Strip Folder,1/32 inch capacity,uses 1 1/4 inch strip,finishes 7/8 inch,for No.48 gauge Styles 51400 B,51400 D .....	28
23435-64	Facing Strip Folder,1/32 inch capacity,uses 1 1/2 inch strip,finishes 1 1/8 inches, for No.64 gauge Style 51700 D .....	28
23436	Facing Strip Folder Washer No.9255 Facing Strip Folder Screw No.22548 Facing Strip Folder Bracket,for Styles 51400 B,51400 D,51700 D (washer No.9255, screw No.136) .....	18
23437 A	Binder Bracket,for Style 51200 B (washer No.12957 E, screw No.22735) .....	19
23437 B	Binder Bracket Support (screw No.22585) ....	19
23438 A	Supplemental Guide Plate,for Style 51200 A (screw No.25 C) .....	—
23439	Pin Tension,for Styles 51200 A,51200 B, (screw No.90) .....	20
<input type="checkbox"/> 28577	Knee Lifter Shaft Hanger Compensating Washer,1/4 inch .....	11
<input type="checkbox"/> 28604	Transmitter Lubricant,No.3 Arctic Cup Grease,5 lb. package .....	—
28606-1/2	Powdered Oil Stone,1/2 lb. package .....	—
28606-1	Powdered Oil Stone,1 lb. package .....	—
29066 F	Needle Lever Connecting Rod Upper Bearing Assembly;one each Nos.51216 A,51243 B lapped together .....	—
29105 A	Looper Lever Eccentric Assembly,for styles in Classes 51400,51700;also Styles 51100 B,51100 C,51200 A,51200 D,51200 E, 51200 G,51900 A; one each Nos.51243 A, 51243 B,51443 lapped together .....	—
29105 B	Looper Lever Eccentric Assembly,for styles in Classes 51300,51500;also Styles 51100 A,51200 B,51200 C,51900 B;one each Nos.51243 A,51243 B,51343 lapped together.	—
29192	Looper Rocker Assembly,for styles in Classes 51100,51200,51300;one each Nos.51213,15465 F,51745 lapped together; also one each Nos.12987 A,22829,and two No.88 .....	—

LIST OF PARTS

Symbol to Order by	The figures in the last column refer only to the plates illustrating the parts and are not to be used in ordering. Refer to pink insert for prices.	Plate No.
29192 A	Looper Rocker Assembly, for styles in Class 51400; one each Nos. 51413, 15465 F, 51745 lapped together; also one each Nos. 12987 A, 22829, and two No. 88 .....	—
29192 B	Looper Rocker Assembly, for styles in Class 51900; one each Nos. 51913, 15465 F, 51745 lapped together; also one each Nos. 12987 A, 22829, and two No. 88 .....	—
29192 C	Looper Rocker Assembly, for styles in Class 51700; one each Nos. 51713, 15465 F, 51745 lapped together; also one each Nos. 12987 A, 22829, and two No. 88 .....	—
29192 D	Looper Rocker Assembly, for styles in Class 51500; one each Nos. 51513, 15465 F, 51745 lapped together; also one each Nos. 12987 A, 22829, and two No. 88 .....	—
29402	Foot Lifter Treadle Assembly; one each Nos. 422, 423, 424, 22813 .....	29
29730 A	"Parallel Take-up" Assembly, for styles in Classes 51200, 51400, 51500, 51700, 51900; one each Nos. 51423, 89, 22764 A, 22833, 51404, 51461, 51461 A, 51461 B, 51461 C and three No. 22794 B .....	—
29730 B	"Parallel Take-up" Assembly, for styles in Class 51300; one each Nos. 51423, 89, 22764 A, 22833, 51461, 51461 A, 51461 B, 51461 C, 51504 and three No. 22794 B .....	—
35558 A	Looper Lever Connection Guard Thread Guide, for styles in Class 51100 (screw No. 94) ..	14
35731 A	Presser Bar Connection Guide Plate (screw No. 22513) .....	12
35754	Looper Rocker Connecting Rod, for styles in Class 51100 (nut, right thread, No. 18, nut, left thread, No. 269) .....	22
35759	Needle Bar Connection .....	17
35791 A	Main Shaft Bearing Housing (screw No. 22569) ..	29
35818 N-8	Needle Holder, marked "C8" for No. 8 gauge Style 51900 B (spot screw No. 89, needle set screw, middle, No. 22752, outer No. 22580) ..	14
35818 N-9	Needle Holder, marked "C9" for No. 9 gauge Style 51900 B (spot screw No. 89, needle set screw, middle, No. 22752, outer No. 22580) ..	14
35820 P-8	Presser Foot Assembly, for No. 8 gauge Style 51900 B; one each Nos. 35830 P-8, 91, 22799 C, 35830, 51930 .....	3
35820 P-9	Presser Foot Assembly, for No. 9 gauge Style 51900 B; one each Nos. 35830 P-9, 91, 22799 C, 35830, 51930 .....	3
35830	Presser Foot Shank, for Styles 51500 A, 51900 B .....	—
35830 P-8	Presser Foot Bottom, for No. 8 gauge Style 51900 B .....	—
35830 P-9	Presser Foot Bottom, for No. 9 gauge Style 51900 B .....	—
35831 A	Needle Thread Controller Rack Thread Guide, for styles in Classes 51200, 51300, 51400, 51500, 51900 (screw No. 604) .....	13

LIST OF PARTS

Symbol to Order by	The figures in the last column refer only to the plates illustrating the parts and are not to be used in ordering. Refer to pink insert for prices.	Plate No.
41047	Looper Connecting Rod, for styles in Class 51700 (nut, right thread, No. 18, nut, left thread, No. 269) .....	12
51101	Cloth Plate, for styles in Class 51100 (screw No. 80) .....	32
51101 P	Cloth Plate Apron (screw No. 22825) .....	31
51101 Q	Cloth Plate Apron Cover, for stitch regulator on styles in Class 51100 .....	26
51108	Looper, for styles in Class 51100 (set screw No. 73) .....	8
51120 B	Presser Foot, for Style 51100 B (clamp screw No. 91) .....	3
51123	Take-up, for styles in Class 51100 (screw, short, No. 89, screw, long, No. 22764 A) .....	25
51124 A	Throat Plate, for Styles 51100 A, 51100 C (screw No. 87) .....	7
51124 B	Throat Plate, for Style 51100 B (screw No. 87) .....	7
51142	Feed Lift Eccentric, for Style 51100 B; also looper avoiding eccentric, for Styles 51100 A, 51100 C (spot screw No. 96) .....	16
51142 A	Feed Lift Eccentric, for Styles 51100 A, 51100 C (spot screw No. 96) .....	16
51147	Main Shaft Collar (screw No. 95) .....	15
51158	Needle Lever Thread Eyelet, for styles in Class 51100 (screw No. 22768) .....	13
51158 A	Needle Bar Thread Eyelet, for styles in Class 51100 (screw No. 22768) .....	13
51159	Frame Needle Thread Guide, left, for styles in Class 51100 (screw No. 94) .....	20
51160	Take-up Thread Eyelet, for styles in Class 51100 (screw No. 79) .....	20
51170 B	Needle Thread Take-up, for styles in Class 51100; also for Styles 51200 A, 51200 B (screw No. 90) .....	20
51170 C	Needle Thread Take-up Wire Post .....	14
51170 D	Needle Thread Take-up Wire Post Lock Nut ...	11
51180	Throat Plate Support, for styles in Class 51100 (screw No. 22839) .....	27
51183	Hand Lifter, for styles in Class 51100 (stud No. 22850) .....	18
51183 A	Hand Lifter Plate (screw No. 75) .....	12
51192	Needle Thread Tension Eyelet, for styles in Class 51100 .....	13
51192 A	Looper Thread Tension Eyelet, for styles in Class 51100 .....	13
51201	Cloth Plate, for styles in Classes 51200, 51300, 51400, 51500, 51900, using throat plate 3 1/8 inches long (screw No. 80) .....	32
51201 A	Cloth Plate, for styles in Classes 51200, 51300, 51500, using throat plate 2 1/4 inches long (screw No. 80) .....	32
51205 A	Feed Dog, for Style 51200 A (screw No. 93) ...	1
51205 D	Feed Dog, for Style 51200 D (screw No. 93) ...	1
51208	Looper, for styles in Class 51300; also for Style 51200 C (set screw No. 73) .....	8
51208 D	Looper, for Styles 51200 D, 51200 E (set screw No. 73) .....	8
51213	Looper Rocker for styles in Classes 51100, 51200, 51300 .....	25

LIST OF PARTS

Symbol to Order by	The figures in the last column refer only to the plates illustrating the parts and are not to be used in ordering. Refer to pink insert for prices.	Plate No.
51215 A	Needle Lever .....	29
51216	Needle Lever Connecting Rod Tube (nut, left thread, No.15430 C, nut, right thread, No.15430 D) .....	22
51216 A	Needle Lever Connecting Rod Bearing, upper (screw No.97 A) .....	25
51216 B	Needle Lever Connecting Rod Bearing, lower (screw No.75 A) .....	25
51217	Needle Bar, for styles in Classes 51100, 51200, 51300 (screw No.88 A) .....	24
51220 A	Presser Foot, for Style 51200 A (clamp screw No.91) .....	3
51220 E	Presser Foot Assembly, for Style 51200 E; one each Nos.51230 E, 91, 91 A, 6235, 51230 .....	4
51221	Pulley, working diameter 2 1/2 inches, for styles in Classes 51400, 51700; also Styles 51100 B, 51100 C, 51200 A, 51200 D, 51200 E, 51200 G, 51900 A (spot screw No.22597, set screw No.22597 A) .....	25
51222	Main Shaft, left section .....	29
51222 A	Main Shaft, crank section, for Styles 51200 B, 51200 C .....	27
51224 A	Throat Plate, for Style 51200 A .....	5
51224 B	Throat Plate, for Style 51200 B .....	5
51224 D	Throat Plate, for Style 51200 D .....	5
51225	Throat Plate Screw No.22570 Needle Guard, for styles in Classes 51100, 51200, 51300 (screw No.22585 B) .....	4
51230	Presser Foot Shank, for Style 51200 E .....	—
51230 E	Presser Foot Bottom, for Style 51200 E .....	—
51234	Feed Bar (screw No.22560 B) .....	18
51234 A	Feed Bar Shaft, 2 1/16 inches long .....	23
51235	Feed Rocker (screw No.98) .....	18
51235 A	Feed Rocker Arm (clamp screw No.93) .....	18
51235 B	Feed Rocker Shaft, 4 7/16 inches long .....	23
51235 C	Feed Rocker Shaft Bushing .....	15
51236	Feed Crank Link (oil wick No.666-19, shim No.1248, screw No.22569, nut No.7947) .....	16
51236 A	Feed Crank Link Pin (screw No.77) .....	17
51236 B	Stitch Regulating Stud Cap (screw No.22768) .....	17
51236 C	Feed Crank Stud (nut No.269) .....	10
51240 A	Looper Connecting Rod, adjusting section, for styles in Classes 51200, 51300, 51400, 51500, 51900 .....	10
51240 C	Looper Connecting Rod Spring .....	11
‡ 51241	Looper Connecting Rod, jointed section and ball joint assembly, right .....	25
‡ 51241 D	Looper Connecting Rod Ball Joint Assembly, left, for styles in Classes 51100, 51200, 51300, 51400, 51500, 51900 .....	16
51242	Looper Bell Crank Lever .....	18
‡ 51242 A	Looper Lever Shaft, 4 9/16 inches long, with bushing (screw No.531) .....	23
51242 C	Looper Lever Shaft Bushing, rear (spot screw No.96) .....	15
‡ 51243 A	Looper Lever Connection (screw, upper, No.75 A, screw, lower, No.97 A) .....	25



LIST OF PARTS

Symbol to Order by	The figures in the last column refer only to the plates illustrating the parts and are not to be used in ordering. Refer to pink insert for prices.	Plate No.
51243 B	Looper Lever Ball Stud;also for No.51215 A (set screw,headless,No.22591,set screw, hexagon head,No.22519) .....	17
51243 C	Looper Lever Ball Stud Guide Fork;also for No.51243 B (screw No.97) .....	17
51243 E	Looper Lever Connection Felt Retainer .....	12
51243 G	Feed Lift Eccentric Oil Tube Clamp,for styles in Class 51100 (screw No.93 A) ....	12
‡ 51243 J	Looper Lever Connection Guard,for styles in Classes 51100,51200,51300,51400,51500, 51900 (screw No.94) .....	28
51244	Looper Rocker Frame,for styles in Classes 51100,51200,51300,51400,51500,51900 (spot screw No.96,set screw No.98) .....	18
51244 A	Looper Rocker Frame Shaft .....	23
51244 B	Looper Rocker Shaft Arm (clamp screw No.93) ..	15
51244 C	Looper Rocker Frame Sleeve,for styles in Classes 51100,51200,51300,51400,51500, 51900 (screw No.88 B) .....	15
51244 E	Looper Rocker Frame Shaft Bushing .....	15
51245	Looper Avoiding Eccentric Link and Feed Lift Eccentric Link (oil wicking No.666-19, shim No.124B,screw No.22569,nut No.7947) .	16
51246	Looper Rocker Stud Nut,for styles in Classes 51100,51200,51300,51400,51500, 51900 .....	11
51250	Needle Lever Stud (screw No.719) .....	23
51250 B	Needle Lever Thrust Collar (screw No.719) ..	15
‡ 51251	Needle Thread Controller Lever Assembly,for styles in Classes 51200,51300,51400,51500, 51900 .....	21
51252	Presser Bar Guide and Thread Controller Rack, for styles in Classes 51200,51300,51400, 51500,51900 (screw No.531) .....	21
51254	Needle Bar Bushing,upper .....	15
51254 A	Needle Bar Bushing,lower .....	15
51256	Presser Spring,for styles in Class 51100 ...	26
51256 A	Presser Spring,upper,for styles in Classes 51200,51300,51400,51500,51700,51900 .....	26
51256 B	Presser Spring,lower,for styles in Classes 51200,51300,51400,51500,51700,51900 .....	26
51257	Presser Bar .....	23
51257 A	Presser Bar Bushing,upper,length overall 2 1/8 inches .....	15
51257 C	Presser Bar Bushing,lower,length overall 1 3/4 inches .....	23
51258	Needle Lever Thread Eyelet,for styles in Classes 51200,51300 (screw No.22768) .....	13
51258 A	Needle Bar Thread Eyelet,for styles in Classes 51200,51300 (screw No.22768) .....	13
51260	Take-up Thread Eyelet,front,for styles in Classes 51200,51300 (screw No.87 U) .....	13
51260 A	Take-up Thread Eyelet,rear,for styles in Classes 51200,51300 (screw No.87 U) .....	13
51270 A	Needle Thread Take-up,for styles in Classes 51300,51400,51500,51700,51900;also for Styles 51200 C,51200 D,51200 E,51200 G (screw No.90) .....	20

‡ See Page 8

LIST OF PARTS

Symbol to Order by	The figures in the last column refer only to the plates illustrating the parts and are not to be used in ordering. Refer to pink insert for prices.	Plate No.
51280	Throat Plate Support, for styles in Classes 51200, 51300, 51400, 51500, 51700, 51900 using throat plates 3 1/8 inches long (screw No. 22839) .....	27
51280 A	Throat Plate Support, for styles in Classes 51200, 51300, 51500 using throat plates 2 1/4 inches long (screw No. 22839) .....	27
51281-216	Cloth Plate Cover Assembly, 6 3/4 inches long, not drilled for attachments; includes spring and three screws .....	27
51281-226	Cloth Plate Cover Assembly, 7 1/16 inches long	27
51281-228	Cloth Plate Cover Assembly, 7 1/8 inches long	27
51281-233	Cloth Plate Cover Assembly, 7 9/32 inches long	27
51281 C-226	Cloth Plate Cover Assembly, 7 1/16 inches long for Styles 51200 A, 51200 B; includes spring and three screws .....	27
51281 E-226	Cloth Plate Cover Assembly, 7 1/16 inches long, for Style 51200 D; includes spring and three screws .....	27
51281 F	Cloth Plate Cover Spring (screw No. 22726 A) ..	26
51282	Louver Cover (screw No. 90) .....	26
51282 A	Crank Chamber Cover, rear (screw No. 90) .....	26
51282 B	Face Plate (thumbscrew No. 22837) .....	26
51282 C	Crank Chamber Cover, upper (screw No. 22524) ..	26
51283	Lifter Lever (stud No. 22566 A) .....	31
51283 A	Lifter Lever Spring .....	11
51283 B	Lifter Lever Spring Pin .....	17
51283 C	Presser Bar Lifter Bracket (screw No. 88) ...	16
51290	Main Shaft Bushing, middle, 3/4 inch long ....	15
51290 A	Main Shaft Bushing, outer, right, 19/32 inch long .....	15
51290 C	Main Shaft Bushing, inner, right, 5/8 inch long	15
51290 D	Main Shaft Bushing, left, 3/4 inch long .....	15
51291	Looper Thread Guard, for styles in Classes 51200, 51300, 51400, 51500, 51700, 51900 (screw No. 22711) .....	26
51292	Tension Post .....	23
51292 A	Tension Post Ferrule, for styles in Classes 51200, 51300, 51400, 51500, 51700, 51900 .....	14
51292 B	Tension Spring Ferrule .....	14
51292 C	Tension Regulating Nut .....	11
51292 D	Needle Thread Tension Eyelet, for styles in Classes 51200, 51300, 51400, 51500, 51700, 51900 .....	13
51292 E	Looper Thread Tension Eyelet, for styles in Classes 51200, 51300, 51400, 51500, 51700, 51900 .....	13
51292 F-2	Tension Spring, .022 inch diam. wire, for looper threads .....	11
51292 F-8	Tension Spring, .037 inch diam. wire, for needle threads .....	11
51292 F-14	Tension Spring, .047 inch diam. wire, for needle threads .....	11
51293	Crank Chamber Oil Gauge (screw No. 97) .....	28
51293 A	Crank Chamber Oil Tube, for outer right main shaft bearing .....	22
51293 B	Crank Chamber Oil Tube Clamp (screw No. 22769)	17
51294	Oil Drain Assembly; one each Nos. 666-16, 51294 A, 51294 B, and two No. 21756 G .....	28
51294 A	Clamp Spring, for oil drain assembly .....	—

LIST OF PARTS

Symbol to Order by	The figures in the last column refer only to the plates illustrating the parts and are not to be used in ordering. Refer to pink insert for prices.	Plate No.
51294 B	Drain Pipe,for oil drain assembly .....	—
51305 A	Feed Dog,for Style 51300 A (screw No.93) ...	1
51305 B	Feed Dog,for Style 51300 B (screw No.93) ...	1
51320 B	Presser Foot Assembly,for Style 51300 B; one each Nos.51330 B, 65 XD,86 X,and two No.88.	4
51321	Pulley,working diameter 3 3/8 inches,for styles in Class 51500;also Style 51900 B (spot screw No.22597,set screw No.22597 A)	25
51321 A	Pulley,working diameter 2 1/2 inches, for styles in Class 51300;also Styles 51100 A, 51200 B,51200 C (spot screw No.22597, set screw No.22597 A) .....	25
51322 A	Main Shaft Crank Section,for styles in Classes 51300,51500;also Styles 51100 A, 51900 B .....	27
51324 B	Throat Plate,for Style 51300 B (screw No.22570) .....	5
51330 B	Presser Foot Bottom,for Style 51300 B .....	—
51343	Looper Lever Eccentric,for styles in Classes 51300,51500;also Styles 51100 A,51200 B, 51200 C,51900 B (spot screw No.96, set screw No.98) .....	16
51404	"Parallel Take-up" Cast Off,for styles in Classes 51200,51400,51500,51700,51900, (screw No.22833) .....	17
51405-8	Feed Dog,for Nos.8,10 and 12 gauge Style 51400 A .....	1
51405-16	Feed Dog,for Nos.16 and 18 gauge Style 51400 A .....	1
51405 B-32	Feed Dog,for No.32 gauge Style 51400 D .....	2
51405 B-48	Feed Dog,for No.48 gauge Styles 51400 B, 51400 D .....	2
51405 C-48	Feed Dog,for No.48 gauge Style 51400 C .....	2
51408-8	Looper,front,for No.8 gauge Style 51400 A ..	8
51408-10	Looper,front,for No.10 gauge .....	8
51408-12	Looper,front,for No.12 gauge .....	8
51408-16	Looper,front,for No.16 gauge .....	8
51408-18	Looper,front,for No.18 gauge .....	8
51408-32	Looper,front,for No.32 gauge Style 51400 D..	8
51408-48	Looper,front,for No.48 gauge Styles 51400 B, 51400 C,51400 D .....	8
51409	Looper,for Styles 51200 A,51200 G;also back looper for Style 51400 A,and middle looper for Style 51900 A .....	8
51409 B	Looper,back,for Styles 51400 B,51400 C, 51400 D .....	8
51413	Looper Set Screw No.73	
51417-8	Looper Rocker,for styles in Class 51400 ....	25
51417-10	Needle Bar,for No.8 gauge Style 51400 A ....	24
51417-12	Needle Bar,for No.10 gauge .....	24
51417-16	Needle Bar,for No.12 gauge .....	24
51417-18	Needle Bar,for No.16 gauge .....	24
51417 B	Needle Bar,for No.18 gauge .....	24
	Needle Bar,for Styles 51400 B,51400 C, 51400 D .....	24
	Needle Bar Set Screw No.88 A	

LIST OF PARTS

Symbol to Order by	The figures in the last column refer only to the plates illustrating the parts and are not to be used in ordering. Refer to pink insert for prices.	Plate No.
51418-16	Needle Holder, marked "D-16", for Nos. 8, 10, 12, 16 and 18 gauge styles in Class 51400; also for No. 16 gauge Style 51500 A .....	14
51418 B-32	Needle Holder, marked "D-32", for No. 32 gauge Style 51400 D .....	14
51418 B-48	Needle Holder, marked "D-48", for No. 48 gauge Styles 51400 B, 51400 C, 51400 D .....	14
	Needle Holder Spot Screw No. 89 Needle Set Screw No. 98	
51420-8	Presser Foot Assembly, for No. 8 gauge Style 51400 A; one each Nos. 51430 A-8, 91, 22799 B, 51430 B .....	3
51420-10	Presser Foot Assembly, for No. 10 gauge Style 51400 A; one each Nos. 51430 A-10, 91, 22799 B, 51430 B .....	3
51420-12	Presser Foot Assembly, for No. 12 gauge Style 51400 A; one each Nos. 51430 A-12, 91, 22799 B, 51430 B .....	3
51420-16	Presser Foot Assembly, for No. 16 gauge Style 51400 A; one each Nos. 51430 A-16, 91, 22799 B, 51430 B .....	3
51420-18	Presser Foot Assembly, for No. 18 gauge Style 51400 A; one each Nos. 51430 A-18, 91, 22799 B, 51430 B .....	3
51420 C-32	Presser Foot Assembly, for No. 32 gauge Style 51400 D; one each Nos. 51430 C-32, 77, 91, 22752 B, 22799 D, 51430 .....	3
51420 C-48	Presser Foot Assembly, for No. 48 gauge Styles 51400 B, 51400 C; one each Nos. 51430 C-48, 77, 91, 22752 B, 22799 D, 51430 .....	3
51422 A	Main Shaft, Crank Section, for styles in Classes 51400, 51700; also for Styles 51100 B, 51100 C, 51200 A, 51200 D, 51200 E, 51200 G, 51900 A .....	27
51423	"Parallel Take-up", for styles in Classes 51200, 51300, 51400, 51500, 51700, 51900 .....	25
51424-8	Throat Plate, for No. 8 gauge Style 51400 A ..	5
51424-10	Throat Plate, for No. 10 gauge .....	5
51424-12	Throat Plate, for No. 12 gauge .....	5
51424-16	Throat Plate, for No. 16 gauge .....	5
51424-18	Throat Plate, for No. 18 gauge .....	5
51424 B-32	Throat Plate, for No. 32 gauge Style 51400 D ..	6
51424 B-48	Throat Plate, for No. 48 gauge Styles 51400 B, 51400 D .....	6
51424 C-48	Throat Plate, for No. 48 gauge Style 51400 C ..	6
	Throat Plate Screw No. 22570	
51425	Needle Guard, for styles in Class 51400 (screw No. 22585 B) .....	4
51430	Presser Foot Shank, for Styles 51400 B, 51400 C, 51400 D, 51700 C, 51700 D .....	—
51430 A-8	Presser Foot Bottom, for No. 8 gauge Style 51400 A .....	—
51430 A-10	Presser Foot Bottom, for No. 10 gauge .....	—
51430 A-12	Presser Foot Bottom, for No. 12 gauge .....	—
51430 A-16	Presser Foot Bottom, for No. 16 gauge .....	—
51430 A-18	Presser Foot Bottom, for No. 18 gauge .....	—
51430 B	Presser Foot Shank, for Style 51400 A .....	—
51430 C-32	Presser Foot Bottom, for No. 32 gauge Style 51400 D .....	—

LIST OF PARTS

Symbol to Order by	The figures in the last column refer only to the plates illustrating the parts and are not to be used in ordering. Refer to pink insert for prices.	Plate No.
51430 C-48	Presser Foot Bottom, for No. 48 gauge Styles 51400 C, 51400 D .....	—
51443	Looper Lever Eccentric, for styles in Classes 51400, 51700; also Styles 51100 B, 51100 C, 51200 A, 51200 D, 51200 E, 51200 G, 51900 A (spot screw No. 96, set screw No. 98) .....	16
51458	Needle Lever Thread Eyelet, for styles in Classes 51400, 51500, 51700 (screw No. 22768)	13
51458 A	Needle Bar Thread Eyelet, for styles in Classes 51400, 51500, 51700 (screw No. 22768)	13
51460	"Parallel Take-up" Thread Eyelet, front for styles in Classes 51400, 51500, 51700 (screw No. 87 U) .....	13
51460 A	"Parallel Take-up" Thread Eyelet, rear (screw No. 87 U) .....	13
51461	"Parallel Take-up" Flange, left, for styles in Classes 51200, 51300, 51400, 51500, 51700, 51900 (screw No. 22794 B) .....	25
51461 A	"Parallel Take-up" Flange, right (screw, short No. 89, screw, long, No. 22764 A) .....	25
51461 B	"Parallel Take-up" Block .....	12
51461 C	"Parallel Take-up" Sleeve .....	15
51462	"Parallel Take-up" Eyelet Stand (screw No. 79)	21
51462 A	"Parallel Take-up" Eyelet Stud .....	10
51462 B	"Parallel Take-up" Eyelet Support (screw No. 22560 B) .....	12
51462 C	"Parallel Take-up" Eyelet Stand Pin .....	22
51504	"Parallel Take-up" Cast-off, for styles in Class 51300 (screw No. 22833) .....	17
51505-18	Feed Dog, for Nos. 16 and 18 gauge Style 51500 A (screw No. 93) .....	2
51508-16	Looper, front, for No. 16 gauge Style 51500 A (screw No. 73) .....	8
51508-18	Looper, front, for No. 18 gauge (screw No. 73)	8
51513	Looper Rocker, for styles in Class 51500 .....	25
51517-16	Needle Bar, for No. 16 gauge Style 51500 A (set screw No. 88 A) .....	24
51517 A	Needle Bar, for No. 18 gauge Style 51500 A (set screw No. 88 A) .....	24
51520-16	Presser Foot Assembly, for No. 16 gauge Style 51500 A; one each Nos. 51530-16, 91, 22799 C, 35830, 51930 .....	3
51520-18	Presser Foot Assembly, for No. 18 gauge Style 51500 A; one each Nos. 51530-18, 91, 22799 C, 35830, 51930 .....	3
51524-16	Throat Plate, for No. 16 gauge Style 51500 A (screw No. 22570) .....	5
51524-18	Throat Plate, for No. 18 gauge (screw No. 22570)	5
51525	Needle Guard, for styles in Class 51500 (screw No. 22585 B) .....	4
51530-16	Presser Foot Bottom, for No. 16 gauge Style 51500 A .....	—
51530-18	Presser Foot Bottom, for No. 18 gauge .....	—
51701	Cloth Plate, for styles in Class 51700 (screw No. 80) .....	32
51705-56	Feed Dog, for No. 56 gauge Style 51700 C .....	2
51705-64	Feed Dog, for No. 64 gauge Style 51700 C .....	2
51705 D-64	Feed Dog, for No. 64 gauge Style 51700 D .....	2
	Feed Dog Screw No. 93	

LIST OF PARTS

Symbol to Order by	The figures in the last column refer only to the plates illustrating the parts and are not to be used in ordering. Refer to pink insert for prices.	Plate No.
51708	Looper, right, for styles in Class 51700 (screw No.73) .....	8
51709	Looper, left, for styles in Class 51700 (screw No.73) .....	8
51713	Looper Rocker, for Styles in Class 51700 ....	25
51717	Needle Bar, for styles in Class 51700 (set screw No.88 A) .....	24
51720-56	Presser Foot Assembly, for No.56 gauge Style 51700 C; one each Nos.51730-56, 77, 91, 22752 B, 22799 D, 51430, 51730 A-56 and two No.91 A .....	3
51720-64	Presser Foot Assembly, for No.64 gauge Style 51700 C; one each Nos.51730-64, 77, 91, 22752 B, 22799 D, 51430, 51730 A-64 and two No.91 A .....	3
51720 D-64	Presser Foot Assembly, for No.64 gauge Style 51700 D; one each Nos.51730 D-64, 77, 91, 22752 B, 22799 D, 51430 .....	3
51724-56	Throat Plate, for No.56 gauge Style 51700 C .	6
51724-64	Throat Plate, for No.64 gauge Style 51700 C .	6
51724 D-64	Throat Plate, for No.64 gauge Style 51700 D .	6
51725	Throat Plate Screw No.22570	
51725	Needle Guard, for styles in Class 51700 (screw No.22585 B) .....	4
51730-56	Presser Foot Bottom, for No.56 gauge Style 51700 C .....	—
51730-64	Presser Foot Bottom, for No.64 gauge .....	—
51730 A-56	Presser Foot Flexible Toe, for No.56 gauge Style 51700 C (screw No.91 A) .....	4
51730 A-64	Presser Foot Flexible Toe, for No.64 gauge Style 51700 C (screw No.91 A) .....	4
51730 D-64	Presser Foot Bottom, for No.64 gauge Style 51700 D .....	—
‡ 51741	Looper Connecting Rod Ball Joint Assembly, left, for styles in Class 51700 (screw No.97 A) .....	16
‡ 51741 B	Looper Connecting Rod Ball Joint Assembly, right, for styles in Classes 51100, 51700 (screw No.97 A) .....	16
‡ 51743 A	Looper Lever Connection Guard, for styles in Class 51700 (screw No.94) .....	28
51744	Looper Rocker Frame, for styles in Class 51700 (spot screw No.96, set screw No.98).	18
51745	Looper Rocker Cone Stud .....	17
51751	Presser Bar Guide, for styles in Classes 51100, 51700 (screw No.531) .....	17
51758	Frame Needle Thread Eyelet, for styles in Classes 51100, 51700 (screw No.94, adapter screw No.22840) .....	14
51758 A	Frame Needle Thread Guide, for styles in Class 51700 (screw No.22730) .....	14
51759	Frame Looper Thread Eyelet, for styles in Class 51700 (screw No.93) .....	13
51770-56	Looper Rocker Link, for No.56 gauge styles in Class 51700 (screw No.22757) .....	16
51770-64	Looper Rocker Link, for No.64 gauge (screw No.22757) .....	16
51771	Looper Rocker Link Bushing .....	15

‡ See Page 8.

LIST OF PARTS

Symbol to Order by	The figures in the last column refer only to the plates illustrating the parts and are not to be used in ordering. Refer to pink insert for prices.	Plate No.
51772-56	Looper Rocker Spacing Plate, for No.56 gauge styles in Class 51700 .....	25
51772-64	Looper Rocker Spacing Plate, for No.64 gauge	25
51773	Looper Rocker Frame Sleeve, for styles in Class 51700 (screw No.88 B) .....	15
51905-5	Feed Dog, for No.5 gauge Style 51900 A .....	2
51905-7	Feed Dog, for Nos.6 and 7 gauge Style 51900 A, No.7 gauge Style 51900 B .....	2
51905 B-9	Feed Dog, for Nos. 8 and 9 gauge Style 51900 B .....	2
	Feed Dog Screw No.93	
51908-5	Looper, front, for No.5 gauge Style 51900 A ..	8
51908-6	Looper, front, for No.6 gauge Style 51900 A ..	8
51908-7	Looper, front, for No.7 gauge Style 51900 A ..	8
51908 A-7	Looper, front, for No.7 gauge Style 51900 B ..	8
51908 A-8	Looper, front, for No.8 gauge Style 51900 B ..	8
51908 A-9	Looper, front, for No.9 gauge Style 51900 B ..	8
51909-5	Looper, back, for No.5 gauge Style 51900 A ...	8
51909-6	Looper, back, for No.6 gauge Style 51900 A ...	8
51909-7	Looper, back, for No.7 gauge Style 51900 A ...	8
51909 A-7	Looper, back, for No.7 gauge Style 51900 B ...	8
51909 A-8	Looper, back, for No.8 gauge Style 51900 B ...	8
51909 A-9	Looper, back, for No.9 gauge Style 51900 B ...	8
51909 B	Looper, for Style 51200 B; also back looper for Style 51500 A and middle looper for Style 51900 B .....	8
	Looper Set Screw No.73	
51913	Looper Rocker, for styles in Class 51900 ....	25
51917-5	Needle Bar, for Nos.5,6 and 7 gauge styles in Class 51900 (screw No.88 A) .....	24
51917-9	Needle Bar, for Nos.8 and 9 gauge styles in Class 51900 (screw No.88 A) .....	24
51918-5	Needle Holder, marked "E-5", for No.5 gauge Style 51900 A .....	14
51918-6	Needle Holder, marked "E-6", for No.6 gauge Style 51900 A .....	14
51918-7	Needle Holder, marked "E-7", for No.7 gauge styles in Class 51900 .....	14
	Needle Holder Spot Screw No.89	
	Needle Set Screw, outer, No.98	
	Needle Set Screw, middle, No.22752 A	
51920-5	Presser Foot Assembly, for No.5 gauge Style 51900 A; one each Nos.51930 B-5, 91, 12935 A, 22799 E, 51930 A .....	3
51920-6	Presser Foot Assembly, for No.6 gauge Style 51900 A; one each Nos.51930 B-6, 91, 12935 A, 22799 E, 51930 A .....	3
51920-7	Presser Foot Assembly, for No.7 gauge Styles 51900 A, 51900 B; one each Nos. 51930 B-7, 91, 12935 A, 22799 E, 51930 A .....	3
51924-5	Throat Plate, for No.5 gauge Style 51900 A ..	7
51924-6	Throat Plate, for No.6 gauge Style 51900 A ..	7
51924-7	Throat Plate, for No.7 gauge Styles 51900 A, 51900 B .....	7
51924 B-8	Throat Plate, for No.8 gauge Style 51900 B ..	7
51924 B-9	Throat Plate, for No.9 gauge Style 51900 B ..	7
	Throat Plate Screw No.22570	
51925	Needle Guard, for styles in Class 51900 (screw No.22585 B) .....	4

LIST OF PARTS

Symbol to Order by	The figures in the last column refer only to the plates illustrating the parts and are not to be used in ordering. Refer to pink insert for prices.	Plate No.
51930	Presser Foot Tilting Spring, for Styles 51900 A, 51900 B .....	11
51930 A	Presser Foot Shank, for Style 51900 A .....	—
51930 B-5	Presser Foot Bottom, for No.5 gauge Style 51900 A .....	—
51930 B-6	Presser Foot Bottom, for No.6 gauge .....	—
51930 B-7	Presser Foot Bottom, for No.7 gauge .....	—
51958	Needle Lever Thread Eyelet, for styles in Class 51900 (screw No.22768) .....	13
51958 A	Needle Bar Thread Eyelet, for styles in Class 51900 (screw No.22768) .....	13
51959	Looper Thread Nipper Support, for styles in Classes 51200, 51300, 51400, 51500, 51900 (screw No.93 A) .....	14
51959 B	Looper Thread Nipper Disk .....	14
51959 C	Looper Thread Nipper Spring .....	11
51959 D	Looper Thread Nipper Nut .....	11
51959 E	Looper Thread Nipper Stud Spacing Collar, for styles in Classes 51200, 51300, 51400, 51500 .....	15
51960	"Parallel Take-up" Thread Eyelet, front, for styles in Class 51900 (screw No.87 U) ...	13
51960 A	"Parallel Take-up" Thread Eyelet, rear, for styles in Class 51900 (screw No.87 U) ...	13





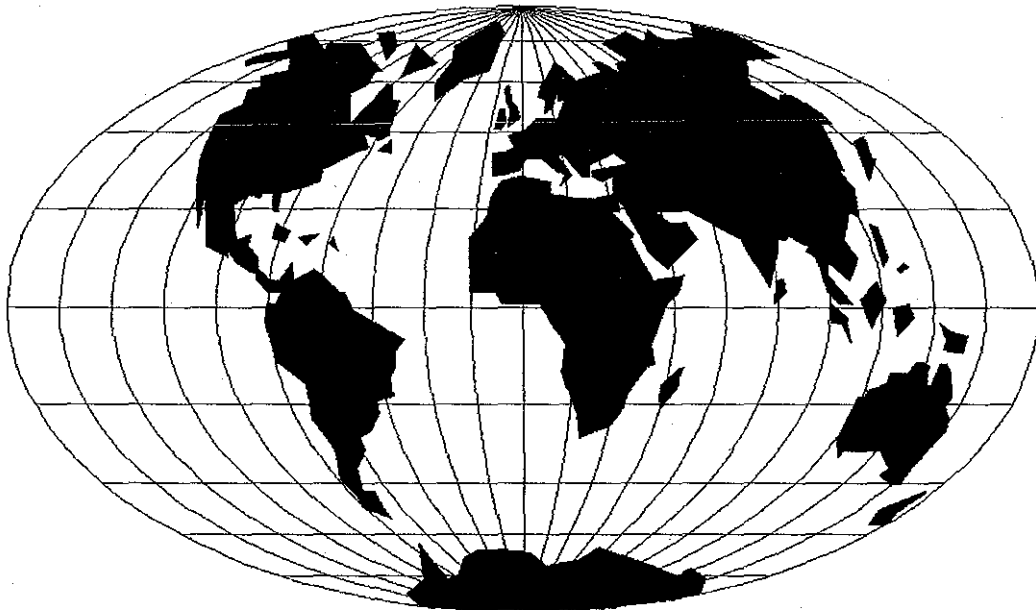

## WORLDWIDE SALES AND SERVICE

Union Special Corporation maintains sales and service facilities throughout the world. These offices will aid you in the selection of the right sewing equipment for your particular operation. Union Special Corporation representatives and service technicians are factory trained and are able to serve your needs promptly and efficiently. Whatever your location, there is a qualified representative to serve you.

---

Corporate Office: One Union Special Plaza  
Huntley, IL 60142  
Phone: 847•669•5101  
Fax: 847•669•4454

European Distribution Center: Union Special GmbH  
Raiffeisenstrasse 3  
D-71696 Möglingen, Germany  
Tel: 49•07141•247•0  
Fax: 49•07141•247•100

Brussels, Belgium  
Charlotte, N.C.  
El Paso, TX  
Hong Kong, China  
Huntley, IL  
Leicester, England  
Lille, France  
Miami, FL  
Milan, Italy  
Möglingen, Germany  
Montreal, Quebec  
Osaka, Japan  
Santa Fe Springs, CA

Other Representatives throughout all parts of the world.



*Union Special*  
INDUSTRIAL SEWING EQUIPMENT