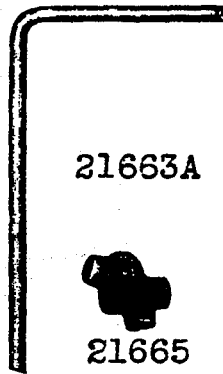
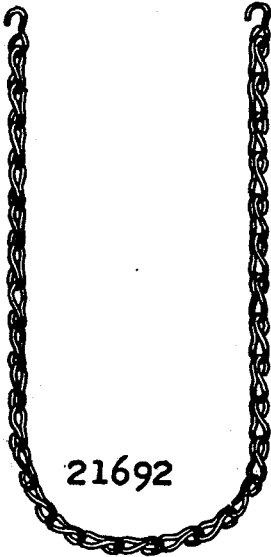
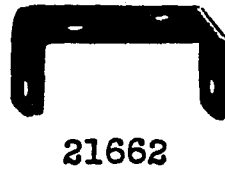

Plate 52 - One-fourth Size



21660A

Plate 53 - One-fourth Size



29402

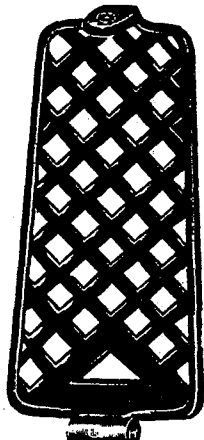

422

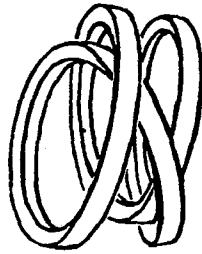

21262H
Specify Length



666-16



23439C



43294A

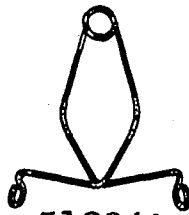

51294A



21104B
Specify
Length

100 B

21172N

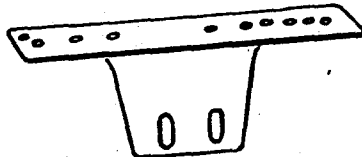

23293N

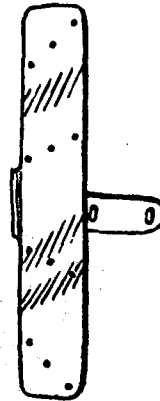

51491B-4

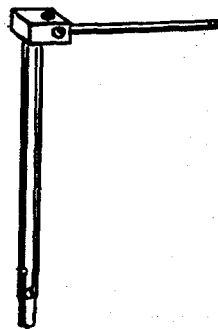

21172M

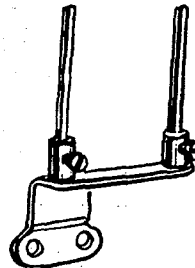

23439B



23324R

Plate 54 - One-fourth Size



23360F-1/2



K49640

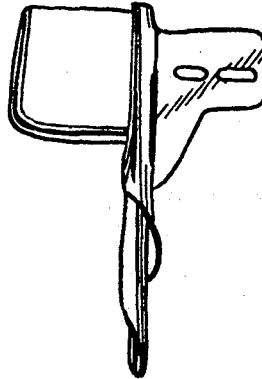

K49746



K59882



K40881

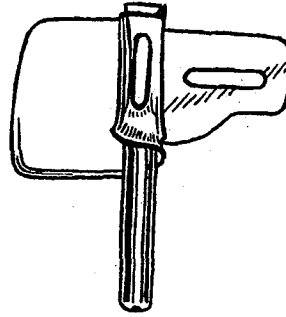

23168Q



23168R



23406B-7/8



23435
Specify Gauge



K59825

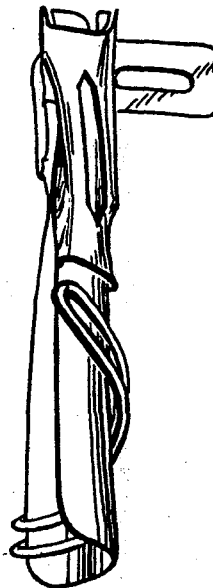

23360C-1 1/2

Plate 55 - One-fourth Size



23401J-56

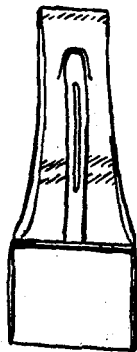

23401K
Specify
Gauge

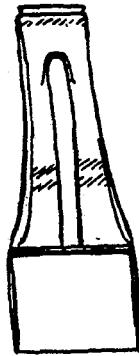

K58357

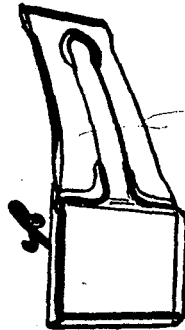

K53135



K53133



23293 P-96

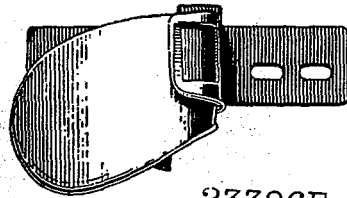

23386E
Specify
Width of Hem



51480

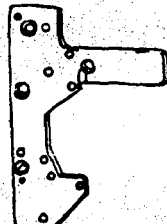

52880

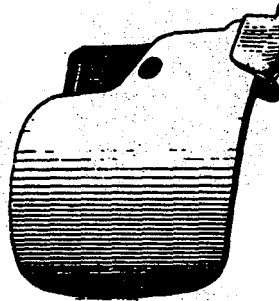

23325T-120



23406A-5/8



51280A



51280G



K60059

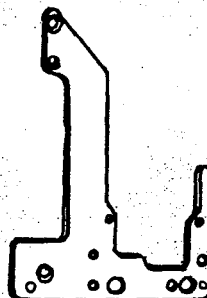

51780A

Plate 56 - One-fourth Size

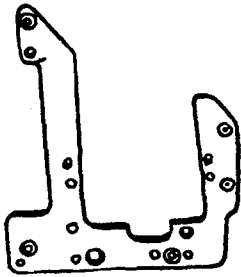

51280B

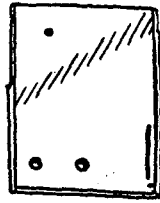

51402

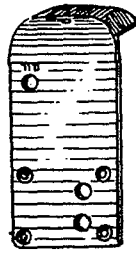

52894 G

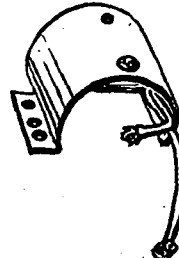

51443G



51281
Specify
Minor
Symbol

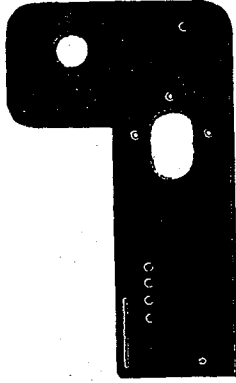

51281C-226

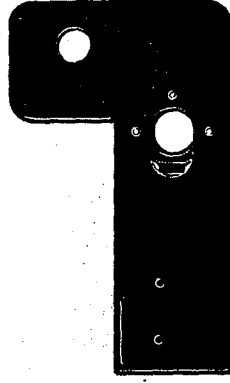

51281 E-226



K54654



52864B

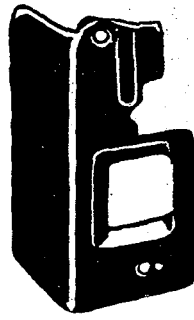

51401C

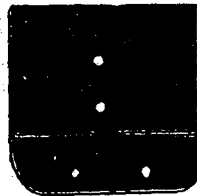

51482A



51282Q

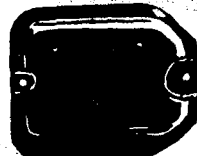

51282E



51282R



51290 N



51290P

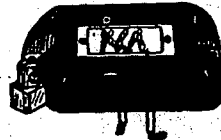

51282 J

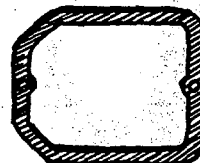

52882E

Plate 57 - One-fourth Size

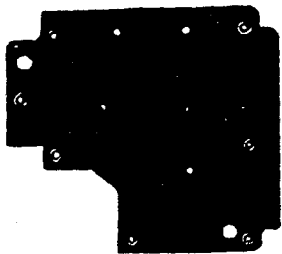

51282L

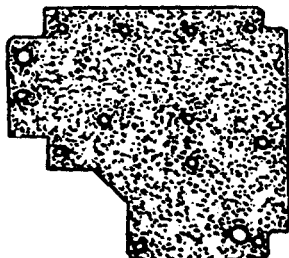

51282M

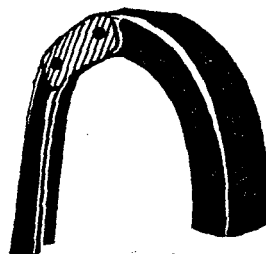

21375AH



51282S



51190D



51722



51222

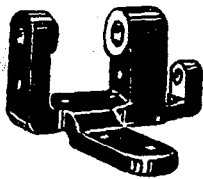

51239 J



7482P



29476 AD

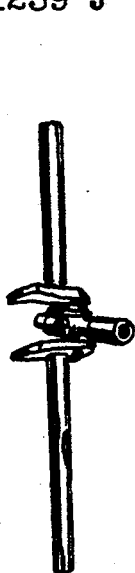

29476 AE



29476 AF

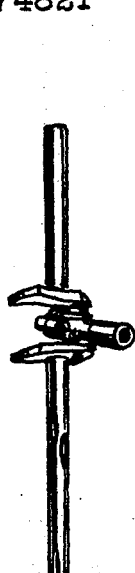

29476AJ



29476AK



29476AY

Plate 58 - One-fourth Size



29348

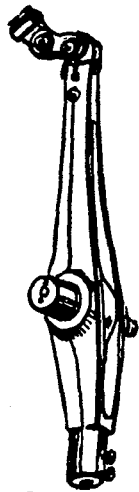

29348B



51215A



51215C

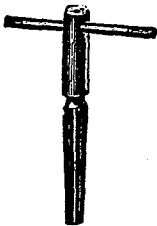

Y802

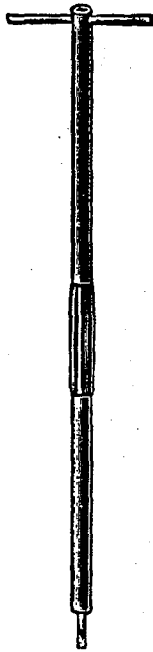

Y500
Specify
Size

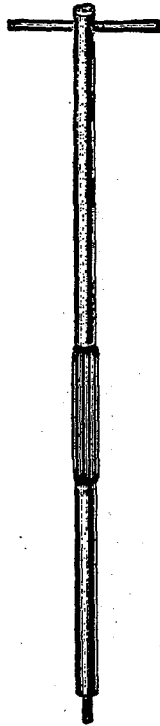

Y502
Specify
Size

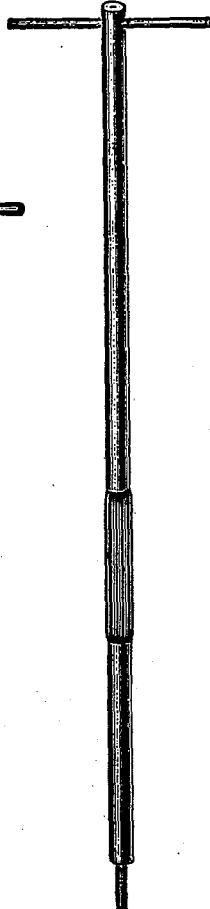

Y505
Specify
Size

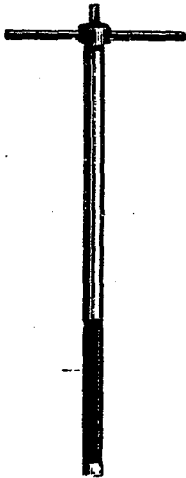

Y503
Specify
Size



Y506
Specify
Size

Plate 59 - One-fourth Size



21204



21203

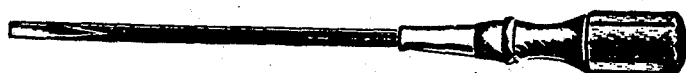

21205A



21202

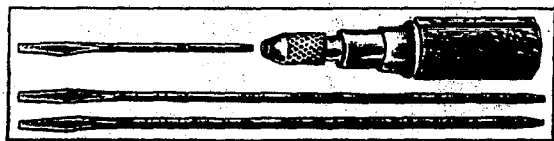

21208



21236

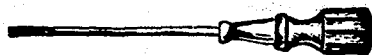

21201

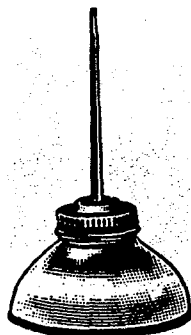

413

Plate 60 - One-eighth Size

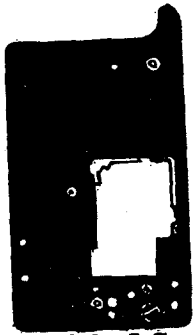

51201C



51301B



51401 D



51701G

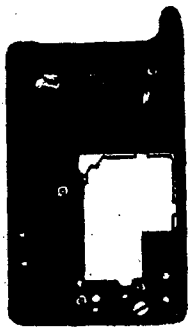

51701P

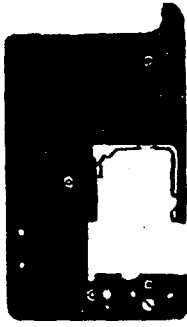

K59922

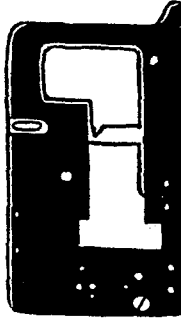

51201B

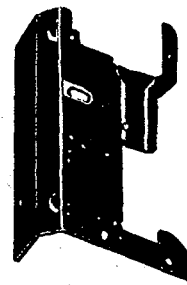

51201 E

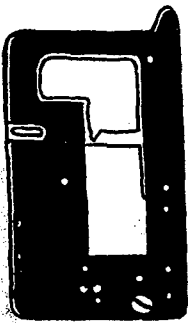

51301A

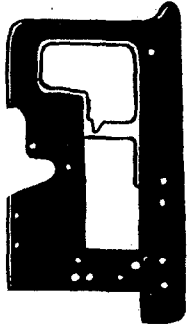

51401H

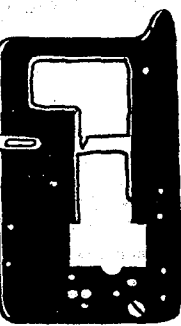

51701C

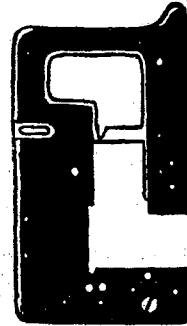

51701F

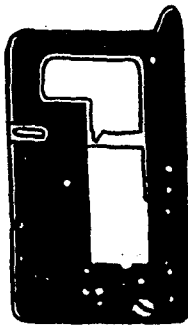

K55601

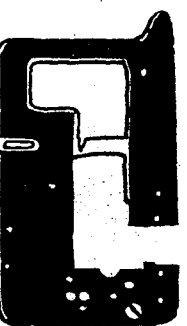

K55603

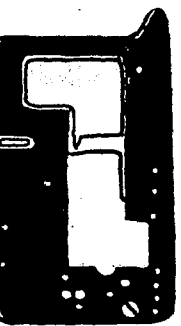

K55765

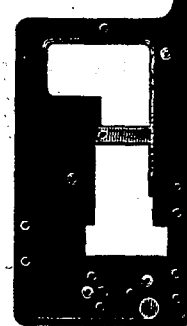

K59465

Plate 61 - One-eighth Size

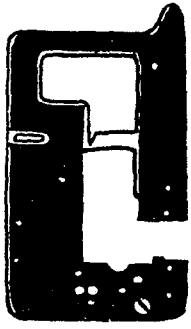

K59466

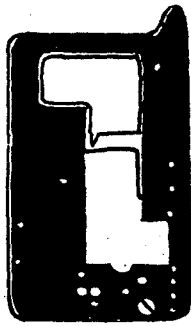

K59510



K59581



21680AK



51264



51482B

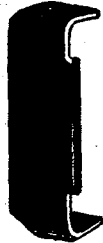

52885A



51285



51239 K

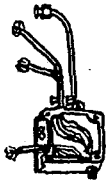

51743B

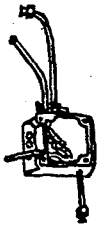

51494

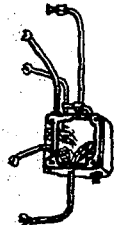

51743F



51294 G



52883



51283E



51283



7486P

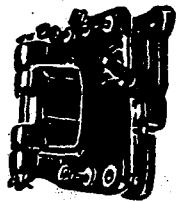

21697AA



21173A



69 S



21104G



21114 A



201A



21693B



ASSEMBLY No 2110IG-2



ASSEMBLY No 2110IH-2

Plate 62 - One-eighth Size



ASSEMBLY N^o 2110IG-4

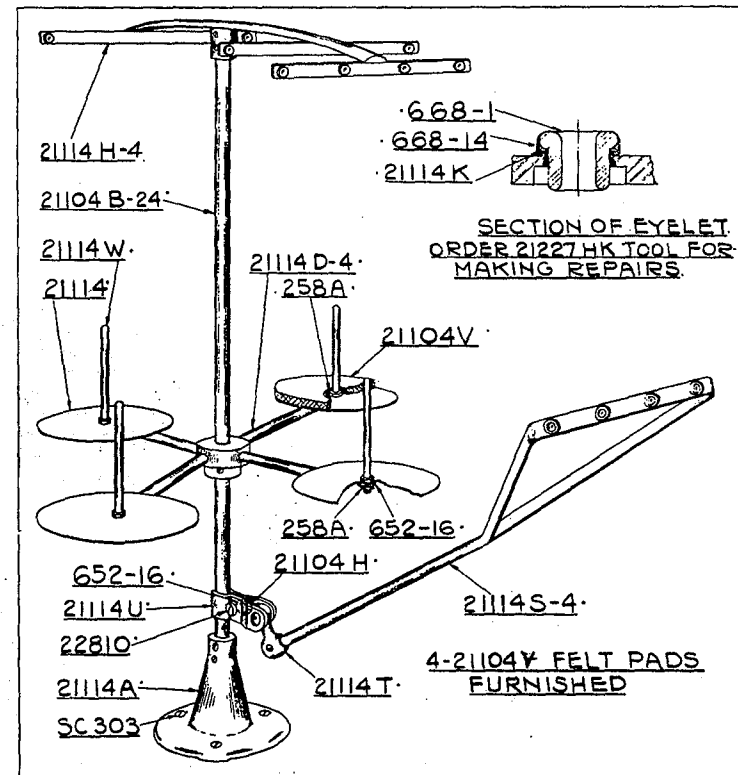

ASSEMBLY N^o 2110IH-4

Plate 64 - One-eighth Size



21130 A-2

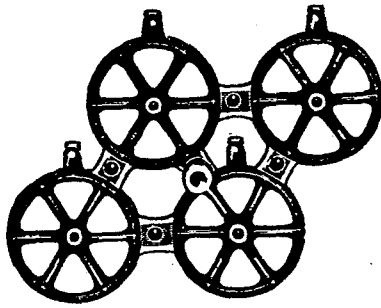

21130A-4



21104K

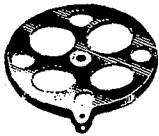

21104D

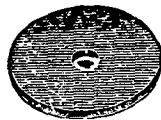

21104F



21169F



21693A



21385B

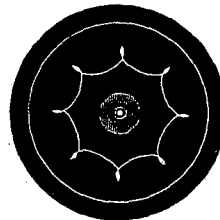

21157



21173B

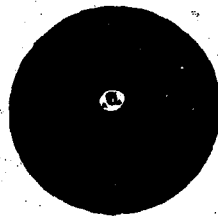

21172E

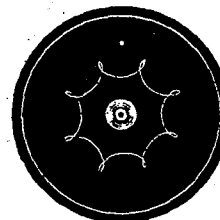

21169E

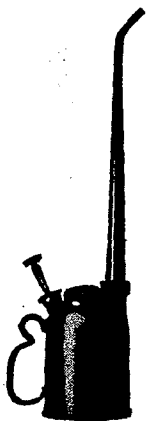

01-19



21388X

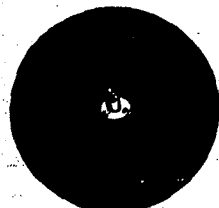

21172F

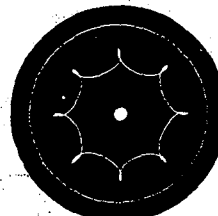

21178

LIST OF PARTS

| Symbol to Order By | The figures in the last column refer only to the plates illustrating the parts and are not to be used in ordering. Prices furnished on application. | Plate No. |
|--------------------------|--|--------------|
| T2 | Pivot Stud, for collapsible folder connection on Styles 51700 F, 51700 M - - - - - | 23 |
| 8 | Feed Rocker Shaft, 5 3/16 inches long, for Styles 51200 U, 51200 V, 51400 AC, 51600 A | 45 |
| 16 | Feed Crank Link Ferrule- - - - - | 26 |
| 18 | Looper Connecting Rod Nut, right thread; also for Nos. 21708 B, 39175, 51241 D, 55241 N- - | 25 |
| OI-19 | Pressure Pump Oil Can, 1 1/2 pints capacity- - | 64 |
| 20 | Feed Crank Stud Washer; also for No. 51758 - - | 26 |
| 22 I | Feed Dog, for Styles 51200 H, 51200 S (screw No. 22528) - - - - - | 7 |
| 24 | Edge Guide, for Styles 51200 H, 51200 S, 51400 K, 51400 X, (thumbscrew No. 25)- - - - - | 33 |
| 24 X | " " for Styles 51200 C, 51200 M (thumbscrew No. 25)- - - - - | 33 |
| 25 | Thumbscrew, for cloth plate edge guides- - - | 24 |
| 25 B | Screw, for angular strip guides on Styles 51400 B, 51400 C, 51400 Q, 51400 R, 51700 C, 51700 D, 51700 J, 51700 K- - - | 20 |
| 25 C | " 9/32 inch long, for cloth plate attach- ments - - - - - | 21 |
| 25 S | " for folder clamp; also for Nos. 51482 A, 51782- - - - - | 21 |
| 25 T | Thumbscrew, for folder swinging arm; also for Nos. 21172 F, 21172 L- - - - - | 24 |
| 25 CC | Screw, for attaching folder clamp to folder; also for Nos. 8372, 23324 J- - - - - | 20 |
| 28 | Screw, for lap seam feller upper scroll; also for Nos. 51235 S, 51704, 52804, 52804 A- - - | 20 |
| 28 C | Adjusting Screw, for stripper blade on Style 51600 A- - - - - | 20 |
| 34 | Nut, for right knee press interlocking lever on knee press assembly No. 21693 A; also for No. 21693 K- - - - - | 25 |
| 36 G | Looper Connecting Rod Ball Stud Washer, for machines equipped with looper drive levers Nos. 51242 E, 51242 J, 51242 T, 51242 V- - - | 26 |
| J42 JK | Screw Pin, for presser roller axle support on Style 51400 G- - - - - | 23 |
| 43 | Feed Lift Eccentric, for styles in Classes 51400, 51700, Styles 51200 A, 51200 D, 51200 G, 51200 H, 51200 K, 51200 N, 51200 R, 51200 S, 51200 U, 51200 V, 51600 A; also looper avoid eccentric for styles in Classes 51400, 51700, Styles 51200 A, 51200 D, 51200 G, 51200 H, 51200 J, 51200 K, 51200 N, 51200 R, 51200 S, 51200 T, 51200 U, 51200 V, 51600 A; (spot screw No. 96) - - - - - | 28 |

LIST OF PARTS

| Symbol to Order By | The figures in the last column refer only to the plates illustrating the parts and are not to be used in ordering. Prices furnished on application. | Plate No. |
|--------------------|---|-----------|
| 43 C | Feed Lift Eccentric, for Styles 51200 B, 51200 C, 51200 J, 51200 L, 51200 M, 51200 T; also looper avoid eccentric for Styles 51200 B, 51200 C, 51200 L, 51200 M; (spot screw No. 96) - - - - - | 28 |
| 50 J-16 | Needle Stop Pin, for Styles 51400 A, 51400 E, 51400 H, 51400 P, 51400 T, 51400 V, 51400 AC; also for Nos. 16 and 18 gauge Style 51400 G - - - - - | 29 |
| 50 J-40 | Needle Stop Pin, for Styles 51400 B, 51400 C, 51400 D, 51400 F, 51400 J, 51400 K, 51400 M, 51400 N, 51400 Q, 51400 R, 51400 S, 51400 U, 51400 W, 51400 X, 51400 Y, 51400 AA, 51400 AB; also for No. 24 gauge Style 51400 G and Nos. 32 and 40 gauge Style 51700 L - - - - - | 29 |
| 52 A | Frame Thread Eyelet, for styles in Class 51200, Style 51400 G; also for No. 52894 G (screw for attaching to frame, No. 98 A; screw for attaching to oil reservoir cover No. 87 U) - - - - - | 18 |
| 54 | Needle Lever Link - - - - - | 41 |
| 56 | Needle Clamp Nut, for Styles 51200 A, 51200 B, 51200 C, 51200 D, 51200 G, 51200 H, 51200 J, 51200 K, 51200 L, 51200 M, 51200 N, 51200 R, 51200 S, 51200 T - - - - - | 25 |
| 57 WB | Needle Bar Thread Nipper Plate, for Style 51400 G - - - - - | 17 |
| 57 WC | Needle Bar Thread Nipper Spring - - - - - | 32 |
| 57 WD | Needle Bar Thread Nipper Stud; also for Nos. 9634, K57341 - - - - - | 22 |
| HA61 D | Screw, for puller connecting rod guard on Style 51400 G - - - - - | 21 |
| 64 A | Presser Spring Regulating Screw, for built-in puller on Style 51400 G - - - - - | 24 |
| 64 B | Presser Spring Regulating Screw Lock Nut, for built-in puller on Style 51400 G - - - - - | 25 |
| 65 A | Presser Foot, hinged bottom, for Styles 51200 H, 51200 S (clamp screw No. 91) - - - - - | 10 |
| 69 S | Spool Pin, 4 inches long, for Style "C" thread stands - - - - - | 61 |
| 69 FD | Screw, square head, cup point, 5/16 inch diameter, 18 threads per inch, 5/8 inch long, for thread stand seat; also for Nos. 21664, 21665, 21693 F, 21693 K - - - - - | 22 |
| 73 | Set Screw, for looper - - - - - | 21 |
| 73 A | Screw, for presser foot strip guide on Styles 51700 G, 51700 H, 51700 N, 51700 P - - - - - | 20 |
| 74 | Clamp Screw, for looper drive lever No. 51242 V - - - - - | 23 |

LIST OF PARTS

| Symbol to Order By | The figures in the last column refer only to the plates illustrating the parts and are not to be used in ordering. Prices furnished on application. | Plate No. |
|--------------------|---|-----------|
| 75 A | Screw, for needle lever connecting rod bearing, lower; also for Nos. 29105 A, 29105 B- - - - - | 23 |
| 77 | Set Screw, for feed crank link pin, and upper needle lever link pin; also for Nos. 39135, 51236 A, 51420 C, 51720, 51720 D - - - - - | 20 |
| 78 | Set screw, for lower needle lever link pin - - - - - | 20 |
| 79 | Screw, for folder support swinging arm base on Styles 51200 U, 51200 V; also for Nos. 7475 Q, 51462 - - - - - | 21 |
| 80 | Screw, for countersunk head, for cloth plates; also for Nos. 51280 A, 51780 A, K60059 - - - - - | 22 |
| 81 | Spot Screw, for puller driving eccentrics; also for Nos. 29114 A, 29114 B, 41258 D, 51242 J, 51242 K, 51242 N, 51242 V - - - - - | 20 |
| 86 | Stud, for collapsible folder scrolls on Styles 51700 F, 51700 M; also for No. 7487 Q - - - - - | 22 |
| 86 X | Presser Foot Hinge Stud, for Styles 51400 M, 51400 AA- - - - - | 22 |
| 87 | Screw, countersunk head, 1/4 inch long, for throat plates; also for No. 51777 L, K53849 - - - - - | 22 |
| 87 A | Screw, countersunk head, for oil reservoir cover on Styles 51200 A, 51200 B, 51200 C, 51200 D, 51200 G, 51200 H, 51200 J, 51200 U, 51200 V, 51400 A, 51400 B, 51400 C, 51400 D, 51400 E, 51400 F, 51400 G, 51400 H, 51400 J, 51400 K, 51400 M, 51400 N, 51400 AC, 51600 A, 51700 C, 51700 D, 51700 E, 51700 F, 51700 G, 51700 H 51700 T - - - - - | 22 |
| 87 U | Screw, for oil reservoir cover thread eyelet; also for Nos. 41358, 51460, 51460 A, 51491, K55764- - - - - | 20 |
| 88 | Set Screw, for looper rocker cone; also for Nos. 161, 1288, 21113 B, 21172 J, 21172 K, 23449, 51420 L, 51430 G, 51720 E, 51774 L, K53842, K53847, K54258- - - - - | 20 |
| 88 A | Set Screw, for needle bar; also for Nos. 51293 P, 51293 R - - - - - | 21 |
| 88 B | Screw, for looper rocker shaft sleeves - - - - - | 20 |
| 89 | Spot Screw, for needle holders; also for Nos. 7486 P, 51461 A, 52836, 52883 G - - - - - | 20 |
| 90 | Screw, for crankshaft chamber cover; also for Nos. 8326, 8326 A, 8326 G, 15226 B, 23215 BC, 23322 AB, 23322 AC, 23438 B, 23439 A, 43281 K, 51170 F, 51270 B, 51759 A, 52864 E, K57284, K58649, K59088, K59499- - - - - | 21 |
| 91 | Clamp Screw, 3/8 inch long, for presser feet- - - - - | 21 |
| 91 A | Screw, for presser foot flexible toe on Styles 51700 C and 51700 J; also for Nos. 6235 and 51420 M, - - - - - | 20 |
| 93 | Screw, for pulley guard; also for Nos. 13153, 23229 M, K49290, 51244 B, 51494, 51743 B, 51743 F, 51774 P, K53845, K53855, K57261 - - - - - | 21 |

LIST OF PARTS

| Symbol to Order By | The figures in the last column refer only to the plates illustrating the parts and are not to be used in ordering. Prices furnished on application. | Plate No. |
|--------------------|---|-----------|
| 93 A | Screw, for looper thread guard; also for Nos. 2603 K, 23324 U, 23324 V, 23401 J, 23401 K, 51959- | 21 |
| 94 | Screw, for thread lead-in guide; also for Nos. 7459A, K51165, 51282 V, 51443 G, 52864 B, K53133, K53135 | 21 |
| 95 | Set Screw, puller driving eccentrics; also for 41258 D, 51147, 51239 D, 53551, 53551 A- | 20 |
| 96 | Spot Screw, for feed lift eccentric and looper avoid eccentric; also Nos. 51244, 51243 P, 51243 Q, 51343, 51423 B, 51443, 51723 A, 51744 A- | 20 |
| 96 A | Spot Screw, for puller feed roller on Style 51400 G, | 20 |
| 97 | Screw, for needle lever and looper drive ball stud guide forks; also for Nos. 51293, 51420 M- | 21 |
| 97 A | Bearing Screw, for looper connecting rod ball joints; also for Nos. 29105 A, 29105 B, 51216 A- | 23 |
| 98 | Set Screw, headless, 3/16 inch long, without pilot for needles; also for Nos. 482, 9271, 51135, 51235, 51243 P, 51243 Q, 51244, 51343, 51443, 51582 | 20 |
| 98 A | Screw, for frame thread eyelets; also for No. 23324 R- | 21 |
| 100 B | Thread Stand Wire, 16 inches long for Style "C" thread stands (set screw No. 22632 F-24) | 53 |
| 107 | Strip Tension Ferrule, for Styles 51400 D, 51400 G, 51400 S, 51700 D, 51700 K, 51700 T, 51700 U- | 18 |
| 108 | Strip Tension Nut- | 25 |
| 109 | Tension Disc, with contact surface 5/64 inch wide, for machines using needle thread the equivalent in size of No. 50 and smaller | 18 |
| 109 B | Tension Disc, with contact surface 1/8 inch wide, for machines using needle thread the equivalent in size of No. 40 and larger | 18 |
| 110-3 | Tension Spring .040 inch diameter for tape reel axle; also for Nos. 21182 N, 21182 T | 32 |
| 112 | Throat Plate, for Styles 51200 H, 51200 S (screw No. 87) | 1 |
| 116 | Wrench, 9/32 inch opening for needle clamp nut | 51 |
| 118 B | Thread Tweezers- | 50 |
| V118 | Tap, marked "X2", for plus size cloth plate screw No. 22521- | 30 |
| 134 | Stud, for collapsible folder connection link on Styles 51700 F, 51700 M- | 22 |
| 136 | Screw, for facing strip folder bracket on Styles 51400 B, 51400 D, 51400 Q, 51400 S, 51700 D, 51700 K, 51700 R- | 21 |

LIST OF PARTS

| Symbol to Order By | The figures in the last column refer only to the plates illustrating the parts and are not to be used in ordering. Prices furnished on application. | Plate No. |
|--------------------|---|-----------|
| 158 B | Frame Looper Thread Eyelet, two holes, for Styles in Classes 51400, 51700, Style 51600 A (screw No. 98 A) - - - - - | 18 |
| 161 | Collar, for binding holder disc on Styles 51200 A, 51200 B, 51200 K, 51200 L, 51200 V (screw No. 88) - - - - - | 26 |
| 166 | Set Screw, hexagonal head, for feed bar on Styles 51200 U, 51400 G - - - - - | 21 |
| 187 A | Screw, for crank shaft chamber cover oil drip plate on Styles 51200 K, 51200 L, 51200 M, 51200 N, 51200 R, 51200 S, 51200 T, 51400 P, 51400 Q, 51400 R, 51400 S, 51400 T, 51400 U, 51400 V, 51400 W, 51400 X, 51400 Y, 51400 AA, 51400 AB, 51700 J, 51700 K, 51700 L, 51700 M, 51700 N, 51700 P, 51700 Q, 51700 R, 51700 U; also for Nos. 8344, 11534, 23300 G, 23360 C, 23449 C, 51282 N, 52782 H, 53582 N, K60416, K60418 - - - - - | 20 |
| 187 B | Screw, for needle holder thread guide; also for No. 1741 B - - - - - | 20 |
| 188 D | Thumbscrew, for pin tension adjustable pin on Style 51200 V - - - - - | 24 |
| 198 B-6 | Presser Foot, for No. 26 gauge Styles 51400 J, 51400 W (clamp screw No. 91) - - - - - | 11 |
| 201 A | Lower Tap Reel Support, Interlining Support, and Elastic Band Support, for Styles 51400 B, 51400 C, 51400 G, 51400 Q, 51400 R, 51400 S, 51700 C, 51700 D, 51700 E, 51700 J, 51700 K, 51700 L - - - - - | 61 |
| 201 C | Thumbscrew, for lower tape reel axle - - - - - | 24 |
| 223 C | Pivot Screw, for presser foot bottom on Style 51200 V - - - - - | 22 |
| 226 | Pivot Screw, for collapsible folder operating rod on Styles 51700 F, 51700 M - - - - - | 22 |
| 236 | Pivot Screw, for cloth plate swinging arm, on Styles 51200 U, 51200 V - - - - - | 23 |
| 243 | Cloth Plate End Cover Spring, on Styles 51200 U, 51200 V, 51400 G (screw No. 22711) - - - - - | 38 |
| 258 | Lock Nut, for differential feed regulating ratchet nut on Style 51200 V - - - - - | 25 |
| 258 A | Nut for Looper Rocker Cone; also for Nos. 21114 W, 51134 G, 52887 N - - - - - | 25 |
| 269 | Looper Connecting Rod Nut, left thread; also for Nos. 21708 B, 21708 C, 51236 C - - - - - | 25 |
| 318 | Screw, for top roller feed clutch bracket on Styles 51200 U, 51200 V - - - - - | 23 |
| 357 | Screw, for cloth plate slide spring on Styles 51400 A, 51400 B, 51400 C, 51400 D, 51400 E, 51400 F, 51400 H, 51400 J, 51400 K, 51400 M, 51400 N, 51400 AC - - - - - | 20 |

LIST OF PARTS

| Symbol to Order By | The figures in the last column refer only to the plates illustrating the parts and are not to be used in ordering. Prices furnished on application. | Plate No. |
|--------------------|--|-----------|
| 358 | Cloth Plate Sliding Cover Knob, for Styles 51200 U, 51200 V - - - - - | 31 |
| 380 | Spring, for cloth plate slide on Styles 51400 A, 51400 B, 51400 C, 51400 D, 51400 E, 51400 F, 51400 H, 51400 J, 51400 K, 51400 M, 51400 N, 51400 AC, (screw No. 357) - - - - - | 31 |
| 402 | Stud, for lifter lever link on Styles 51200 K, 51200 L, 51200 M, 51200 N, 51200 R, 51200 S, 51200 T, 51400 P, 51400 Q, 51400 R, 51400 S, 51400 T, 51400 U, 51400 V, 51400 W, 51400 X, 51400 Y, 51400 AA, 51400 AB, 51700 J, 51700 K, 51700 L, 51700 M, 51700 N, 51700 P, 51700 Q, 51700 R, 51700 U; also for No. 23324 R - - - - - | 23 |
| 413 | Oil Can, complete - - - - - | 59 |
| 420 | Presser Roller Lifter Lever Stud, length overall 1 43/64 inches for Style 51400 G - - - - - | 24 |
| 420 C | Presser Roller Lifter Lever Stud, length overall 2 5/16 inches, for Style 51400 G (nut No. 11635 B) - - - - - | 24 |
| 421 | Lifter Lever Chain, 38 inches long - - - - - | 50 |
| 421 C-34 | Treadle Chain, 34 inches long - - - - - | 50 |
| 422 | Lifter Treadle (screw No. 22813) - - - - - | 53 |
| 423 | Lifter Treadle Base - - - - - | 50 |
| 424 | Lifter Treadle Pin (set screw No. 22813) - - - - - | 45 |
| 426 | Lifter Lever Spring, for Styles 51200 K, 51200 L, 51200 M, 51200 N, 51200 R, 51200 S, 51200 T, 51400 P, 51400 Q, 51400 R, 51400 S, 51400 T, 51400 U, 51400 V, 51400 W, 51400 X, 51400 Y, 51400 AA, 51400 AB, 51700 J, 51700 K, 51700 L, 51700 M, 51700 N, 51700 P, 51700 Q, 51700 R, 51700 U; also for No. 23360 C-1 1/2 - - - - - | 32 |
| 482 | Feed Rocker Shaft Collar (set screw No. 98) - - - - - | 42 |
| Y500-257 | Expansion Reamer, for needle bar bearings, size .257 inch - - - - - | 58 |
| Y502-319 | Expansion Reamer, for upper presser bar bearing, size .319 inch - - - - - | 58 |
| Y503-319 | " " for lower presser bar bearing, size .319 inch - - - - - | 58 |
| Y505-407 | " " for looper rocker and feed rocker shaft bearings, size .407 inch - - - - - | 58 |
| Y506-530 | " " for main shaft bearings, size .530 inch - - - - - | 58 |
| 538 | Screw, for supporting feed dogs - - - - - | 22 |
| 604 | Screw, for intermediate gear guard on Styles 51700 E, 51700 L; also for No. 16241 - - - - - | 20 |

LIST OF PARTS

| Symbol to Order By | The figures in the last column refer only to the plates illustrating the parts and are not to be used in ordering. Prices furnished on application. | Plate No. |
|--------------------|--|-----------|
| 605 A | Screw, for differential feed gear yoke on Styles 51700 E, 51700 L; also for Nos. 7933, 8040, 9735, 16194, 23449 B, 51720 E, 51774 T- | 20 |
| 627 | Clamp Screw, for looper drive lever rocker on Styles 51200 K, 51200 L, 51200 M, 51200 N, 51200 R, 51200 S, 51200 T, 51400 P, 51400 Q, 51400 R, 51400 S, 51400 T, 51400 U, 51400 V, 51400 W, 51400 X, 51400 Y, 51400 AA, 51400 AB, 51700 J, 51700 K, 51700 L, 51700 M, 51700 N, 51700 P, 51700 Q, 51700 R, 51700 U- | 22 |
| 650 | Stove Bolt, flat head 1/4 x 1 1/4 inches- | 25 |
| 650-28 | Stove Bolt, 1/4 x 3 1/2 inches - - - - - | 25 |
| 650-40 | Stove Bolt, 1/4 x 5 inches - - - - - | 25 |
| 650 A-16 | Stove Bolt, flat head, 5/16 x 2 inches - - - - - | 25 |
| 650 A-18 | " " 5/16 x 2 1/4 inches- - - - - | 25 |
| 650 A-20 | " " 5/16 x 2 1/2 inches- - - - - | 25 |
| 650 B-26 | " " flat head, 3/8 x 3 1/4 inches, for table tops - - - - - | 25 |
| 650 X-18 | Carriage Bolt, 5/16 x 2 1/4 inches, for attaching "Electro Drives" - - - - - | 24 |
| 650 X-22 | Carriage Bolt, 5/16 x 2 3/4 inches, for attaching "Electro Drives" - - - - - | 24 |
| 650 X-32 | Carriage Bolt, 5/16 x 4 Inches, for attaching "Electro Drives" - - - - - | 24 |
| 652-16 | Washer, 1/4 inch - - - - - | 26 |
| 652 C-9 | Shake-Proof Lock Washer, for needle bar eyelet | 26 |
| 660-75 | Connection Sleeve Coupling, for Styles 51700 F, 51700 G, 51700 T- - - - - | 19 |
| 660-81 | Oil Drain Extension Pipe, for machines with Class 21700 Puller - - - - - | 49 |
| 660-90 | Felt Wiper, for looper drive eccentric connection on Styles 51200 A, 51200 B, 51200 C, 51200 D, 51200 G, 51200 H, 51200 J, 51200 U, 51200 V, 51400 A, 51400 B, 51400 C, 51400 D, 51400 E, 51400 F, 51400 G, 51400 H, 51400 J, 51400 K, 51400 M, 51400 N, 51400 AC, 51600 A, 51700 C, 51700 D, 51700 E, 51700 F, 51700 G, 51700 H, 51700 T- - - - - | 19 |
| 660-92 | Leather Washer, upper, for main shaft oil gauge on Styles 51200 A, 51200 B, 51200 C, 51200 D, 51200 G, 51200 H, 51200 J, 51200 U, 51200 V, 51400 A, 51400 B, 51400 C, 51400 D, 51400 E, 51400 F, 51400 G, 51400 H, 51400 J, 51400 K, 51400 M, 51400 N, 51400 AC, 51600 A, 51700 C, 51700 D, 51700 E, 51700 F, 51700 G, 51700 H, 51700 T; also for No. 39193- - - - - | 26 |
| 660-93 | Leather Washer, lower, 1/4 inch hole, for main shaft oil gauge; also for No. 39193- - - - - | 26 |

LIST OF PARTS

| Symbol to Order By | The figures in the last column refer only to the plates illustrating the parts and are not to be used in ordering. Prices furnished on application. | Plate No. |
|--------------------------|--|--------------|
| 660-94 | Glass Tube, for main shaft oil gauge- - - - - | 47 |
| 660-95 | Cap, for main shaft oil gauge - - - - - | 19 |
| 660-127 | Isolated Insulator Height Adjusting Felt Washers (set of 8) for "II" installations - - - - - | 31 |
| 660-136 | Feed Crank Link Oil Tube (nut No. 12987 A)- - - | 46 |
| 666-13 | Felt Wick, spring pressed, for main shaft bearings- - - - - | 19 |
| 666-16 | Oil Drain Reservoir, glass- - - - - | 53 |
| 666-19 | Felt Wick, for needle lever connecting rod bearing; also for No. 51236 - - - - - | 19 |
| 666-28 | Oil Cup, for needle lever stud (nut No. 12987 A)- - - - - | 19 |
| 666-29 | Felt Wick, for needle lever stud- - - - - | 47 |
| 666-49 | Glass Tube, for crank chamber oil reservoir sight gauge on Styles 51200 A, 51200 B, 51200 C, 51200 D, 51200 G, 51200 H, 51200 J, 51200 U, 51200 V, 51400 A, 51400 B, 51400 C, 51400 D, 51400 E, 51400 F, 51400 G, 51400 H, 51400 J, 51400 K, 51400 M, 51400 N, 51400 AC, 51600 A, 51700 C, 51700 D, 51700 E, 51700 F, 51700 G, 51700 H, 51700 T - - - - - | 19 |
| 666-50 | Oil Cup, press fit, for upper oil reservoir cover on Styles 51200 A, 51200 B, 51200 C, 51200 D, 51200 G, 51200 H, 51200 J, 51200 U, 51200 V, 51400 A, 51400 B, 51400 C, 51400 D, 51400 E, 51400 F, 51400 G, 51400 H, 51400 J, 51400 K, 51400 M, 51400 N, 51400 AC, 51600 A, 51700 C, 51700 D, 51700 E, 51700 F, 51700 G, 51700 H, 51700 T- - - - - | 19 |
| 666-66 | Oil Tube, for looper drive eccentric assemblies Nos. 29105 L, 29105 M - - - - - | 19 |
| 666-74 | Oil Line "T" Coupling, 1 inch long, for oil line to main shaft bearings on Style 51400 G- | 46 |
| 666-77 | Constant Level Oiler, for Styles 51200 K, 51200 L, 51200 M, 51200 N, 51200 R, 51200 S, 51200 T, 51400 P, 51400 Q, 51400 R, 51400 S, 51400 T, 51400 U, 51400 V, 51400 W, 51400 X, 51400 Y, 51400 AA, 51400 AB, 51700 J, 51700K, 51700 L, 51700 M, 51700 N, 51700 P, 51700 Q, 51700 R, 51700 U- - - - - | 47 |
| 666-77 A | Top, for constant lever oiler - - - - - | - |
| 666-77 B | Spring and Hinge Pin, for constant level oiler- | - |
| 666-77 C | Gasket, for constant level oiler- - - - - | - |
| 666-82 | Oil Wick, for feed lift and looper avoid eccen- tric bearing on Styles 51200 K, 51200 L, 51200 M, 51200 N, 51200 R, 51200 S, 51200 T, 51400 P, 51400 Q, 51400 R, 51400 S, 51400 T, 51400 U, 51400 V, 51400 W, 51400 X, 51400 Y, 51400 AA, 51400 AB, 51400 AC, 51700 J, 51700 K, 51700 L, 51700 M, 51700 N, 51700 P, 51700 Q, 51700 R, 51700 U - - - - - | 19 |

LIST OF PARTS

| Symbol to Order By | The figures in the last column refer only to the plates illustrating the parts and are not to be used in ordering. Prices furnished on application. | Plate No. |
|--------------------|---|-----------|
| 667 D-16 | Dowell Pin, 1 inch long, for puller frame on Style 51400 G- | 29 |
| 668-1 | Steel Insert, 17/64 inch long, for thread lead-in eyelet; also for Nos. 21114 H, 21114 S- | 18 |
| 668-7 | Steel Insert, 5/32 inch long, for tension thread eyelets | 18 |
| 668-12 | Steel Insert Locking Ferrule, for tension thread eyelets | 18 |
| 668-13 | Steel Insert Locking Ferrule, for take-up thread eyelets on Style 51400 G- | 18 |
| 668-14 | Steel Insert Locking Ferrule, for thread lead-in eyelet; also for Nos. 21114 H, 21114 S, | 18 |
| 719 | Set Screw, for needle lever stud; also for Nos. 51250 B, 52835 U- | 20 |
| Y802 | Taper Reamer, for needle lever link and feed crank link pins | 58 |
| 907 | Differential Feed Regulating Stud Nut on Styles 51200 V, 51400 AC, 51600 A- | 25 |
| 1248 | Feed Crank Link Shim, leather- | 19 |
| 1280 | Looper Rocker Stud Nut, for Class 51700- | 25 |
| 1286 | Needle Lever Link Pin Assembly; also feed crank link pin assembly; one each Nos. 1286 A, 1286 B, 12964 C, 22560- | 29 |
| 1286 A | Needle Lever Link Pin (set screw for upper link pin No. 77, clamp screw for upper link pin No. 22864, clamp screw nut No. 51250 C, set screw for lower link pin No. 78)- | 29 |
| 1286 B | Needle Lever Link Pin Spring; also for No. HA1286 (screw No. 22560) | 32 |
| HA1286 | Presser Roller Fork Pin, for Style 51400 G (screw No. 22560 B)- | 29 |
| 1287 | Needle Bar Thread Nipper Assembly, for Style 51400 G; one each Nos. 57 WB, 57 WC, 57 WD, 88, 1288 | 18 |
| 1288 | Needle Bar Thread Nipper Collar (screw No. 88)- | 18 |
| 1332 | Stop Screw Pin, for lifter lever on Styles 51200 K, 51200 L, 51200 M, 51200 N, 51200 R, 51200 S, 51200 T, 51400 P, 51400 Q, 51400 R, 51400 S, 51400 T, 51400 U, 51400 V, 51400 W, 51400 X, 51400 Y, 51400 AA, 51400 AB, 51700 J, 51700 K, 51700 L, 51700 M, 51700 N, 51700 P, 51700 Q, 51700 R, 51700 U | 23 |
| 1346 | Strip Tension Post, for Styles 51400 D, 51400 G, 51400 S, 51700 D, 51700 K, 51700 T, 51700 U | 18 |

LIST OF PARTS

| Symbol to Order By | The figures in the last column refer only to the plates illustrating the parts and are not to be used in ordering. Prices furnished on application. | Plate No. |
|--------------------------|---|--------------|
| 1349 A-5 | Tension Spring, conical, .040 inch diameter wire, for piping strip holder axle on Styles 51700 G, 51700 H, 51700 N, 51700 P- - - - - | 32 |
| 1727 A | Presser Foot, for Styles 51200 D, 51200 N (clamp screw No. 91)- - - - - | 10 |
| 1740 | Presser Foot Yielding Section Plunger Pin, for Nos. 64, 72 and 80 gauge Styles 51700 E, 51700 L - - - - - | 29 |
| 1741 B | Presser Foot Chain Cutting Knife, for Styles 51200 D, 51200 N (screw No. 187 B) | 14 |
| 2603 K | Edge Guide, for Styles 51200 D, 51200 N (screw No. 187 B) (attaching screw No. 93 A, roller No. 16675, roller pin No. 16676, roller arm spring No. 14775 A, throw-out lever screw No. 22772)- - - - - | 35 |
| 4761 | Looper Connecting Rod, 2 1/16 inches long for Nos. 112 and 128 gauge Styles in Class 51700 (nut, right thread, No. 18 nut, left thread, No. 269)- - - - - | 30 |
| 5650 | Main Feed Dog Holder, for Style 51200 V (screw No. 93)- - - - - | 17 |
| 6042 A | Cloth Plate Cover Spring Washer, for Styles 51200 M, 51200 R, 51200 S, 51200 T, 51400 P, 51400 Q, 51400 R, 51400 S, 51400 T, 51400 U, 51400 V, 51400 W, 51400 X, 51400 Y, 51400 AA, 51400 AB, 51700 J, 51700 K, Nos. 32 and 40 gauge Style 51700 L, Styles 51700 N, 51700 P, 51700 Q, 51700 R; also for No. 51134 G - - - - - | 26 |
| 6405 M | Feed Dog, for Styles 51200 B, 51200 L - - | 8 |
| 6405 U | " " for Styles 51200 J, 51200 T - - | 8 |
| 6405 W | " " for Styles 51200 C, 51200 M - - | 8 |
| 6420 W | Feed Dog Screw No. 22528 | |
| | Presser Foot, for Styles 51200 B, 51200 C, 51200 L, 51200 M (clamp screw No. 91, adjusting screw No. 22840 A, adjusting screw nut No. 51430 F)- - - - - | 10 |
| 6424 W | Throat Plate, for Styles 51200 C, 51200 M | 1 |
| 6428 L | " " for Styles 51200 J, 51200 T | 1 |
| K6805 | Throat Plate Screw No. 87 | |
| | Folder, upper, for gathering and stitching flounce to body of petticoats on No. 8 gauge Style 51600 A, 3/16 inch fold (screw No. 22561)- - - - - | 33 |
| K6806 | Folder, lower, for turning edge of flounce on No. 8 gauge Style 51600 A, 3/16 inch fold (screw No. 25 C) - - - - - | 33 |
| 7005 A-4 1/2 | Feed Dog, for No. 16 gauge, Styles 51400 H, 51400 V (screw No. 22528)- - - | 7 |
| 7005 A-6 | Feed Dog, for No. 18 gauge, Styles 51400 H, 51400 V (screw No. 22528)- - - | 7 |

LIST OF PARTS

| Symbol to Order By | The figures in the last column refer only to the plates illustrating the parts and are not to be used in ordering. Prices furnished on application. | Plate No. |
|--------------------|--|-----------|
| 7018 E-5 | Needle Holder, for No. 18 gauge Styles 51400 G, 51400 H, 51400 V - - - - - | 17 |
| 7018 E-5 1/2 | Needle Holder, for No. 24 gauge Style 51400 G- - - - - | 17 |
| 7018 E-6 | Needle Holder, for No. 26 gauge Styles 51400 J, 51400 W - - - - - | 17 |
| | Needle Holder Spot Screw No. 89 Needle Set Screw No. 98 | |
| 7020 B-4 1/2 | Presser Foot, for No. 16 gauge Styles 51400 H, 51400 V - - - - - | 11 |
| 7020 B-5 | Presser Foot, for No. 18 gauge Style 51400 H, 51400 V - - - - - | 11 |
| | Presser Foot Clamp Screw No. 91 | |
| 7024 C-4 1/2 | Throat Plate, for No. 16 gauge Styles 51400 H, 51400 V - - - - - | 1 |
| 7024 C-5 | " " for No. 18 gauge Styles 51400 H, 51400 V - - - - - | 1 |
| | Throat Plate Screw No. 87 | |
| 7040-6 | Thread Guide, detachable, for needle holders on No, 18 gauge Styles 51400 G, 51400 H, 51400 V, No. 24 gauge Style 51400 G, No. 26 gauge Styles 51400 J, 51400 W- - - - - | 17 |
| 7040-48 | Thread Guide, detachable, for needle holders on Nos. 56 and 64 gauge styles in Class 51700 - - - - - | 17 |
| 7040-61 | Thread Guide, detachable, for needle holders on Nos. 72, 80, and 88 gauge styles in Class 51700- - - - - | 17 |
| | Thread Guide Screw No. 187 B | |
| 7403 P | Supplemental Edge Guide, for Style 51400 G (screw No. 25 C) - - - - - | 35 |
| 7405 B-6 | Feed Dog, for No. 26 gauge Styles 51400 J, 51400 W - - - - - | 8 |
| 7405 U-4 1/2 | Feed Dog, for No. 16 gauge Style 51400 G - | 7 |
| 7405 AF-5 1/2 | Feed Dog, for No. 24 gauge Style 51400 G - | 8 |
| 7405 AG-5 | Feed Dog, for No. 18 gauge Style 51400 G - | 8 |
| | Feed Dog Screw No. 22528 | |
| 7420 AG-4 1/2 | Presser Foot, for No. 16 gauge Style 51400 G- - - - - | 11 |
| 7420 AG-5 | Presser Foot, for No. 18 gauge - - - - - | 11 |
| 7420 AG-5 1/2 | Presser Foot, for No. 24 gauge - - - - - | 11 |
| | Presser Foot Clamp Screw No. 91 | |
| 7424 B-6 | Throat Plate, for No. 26 gauge Styles 51400 J, 51400 W - - - - - | 1 |
| 7424-AF-5 1/2 | Throat Plate, for No. 24 gauge Style 51400 G- - - - - | 2 |
| 7424 AG-5 | Throat Plate, for No. 18 gauge Style 51400 G- - - - - | 2 |
| | Throat Plate Screw No. 87 | |

LIST OF PARTS

| Symbol to Order By | The figures in the last column refer only to the plates illustrating the parts and are not to be used in ordering. Prices furnished on application. | Plate No. |
|--------------------------|---|--------------|
| 7459 A | Take-up Thread Eyelet Spring, for Style 51400 G (screw No. 94) - - - - - | 31 |
| 7475 Q | Puller Feed Clutch Flange, for Style 51400 G (screw No. 79) - - - - - | 42 |
| 7476 P | Lower Puller Roller Shaft, for Style 51400 G - - - - - | 45 |
| 7479 P | Lower Puller Roller Shaft Bushing, 63/64 inch long, for Style 51400 G - - - - - | 26 |
| 7481 P | Presser Roller Axle Support, for Style 51400 G (stop pin No. J42 JK) - - - - - | 43 |
| 7482 P | Presser Roller Hand Lifter Lever, for Style 51400 G (stud No. 420, nut No. 12982, set screw No. 92201) - - - - - | 57 |
| 7485 P | Puller Connecting Rod Guard, for Style 51400 G (set screw No. HA61 D, Attach- ing screw No. 22517) - - - - - | 43 |
| 7486 P | Presser Roller Lifter Lever, for Style 51400 G (screw No. 89, stud 420 C, nut No. 11635 B) - - - - - | 61 |
| 7486 PA | Presser Roller Lifter Lever Angle Plate, for Style 51400 G (screw No. 22542) - - | 31 |
| 7487 Q | Presser Spring, for puller lifter lever on Style 51400 G (Stud No. 86) - - - - - | 43 |
| 7489 P | Presser Roller Axle Support Guide Pin, for Style 51400 G - - - - - | 45 |
| 7490 P | Puller Feed Roller, for Style 51400 G (spot screw No. 96 A, set screw No. 22597) - - - - - | 43 |
| 7491 P | Puller Presser Roller, for Style 51400 G - | 43 |
| 7528 H-4 1/2 | Throat Plate, for No. 16 gauge Style 51400 G (screw No. 87) - - - - - | 2 |
| 7933-48 | Needle Stop Plate, for Nos. 56 and 64 gauge styles in Class 51700 - - - - - | 17 |
| 7933-61 | Needle Stop Plate, for Nos. 72, 80, and 88 gauge styles in Class 51700 - - - - - | 17 |
| 7947 8040 | Needle Stop Plate Screw No. 605 A Feed Crank Link Nut; also for No. 51245 Presser Foot Yielding Section Spring, for Nos. 64, 72, and 80 gauge Styles 51700 E, 51700 L, No. 128 gauge Styles 51700 G, 51700 H, 51700 N, 51700 P (attaching screw No. 605 adjusting screw No. 605 A) - - - - - | 25 |
| 8118-64 | Needle Holder, for No. 64 gauge styles in Class 51700 (spot screw No. 89, needle set screw No. 98) - - - - - | 32 |
| 8305 L | Main Feed Dog, for No. 16 gauge Style 51600 A - - - - - | 17 |
| 8305 N | " " " for No. 12 gauge Style 51600 A - - - - - | 7 |
| 8305 S | " " " for No. 10 gauge Style 51600 A - - - - - | 7 |
| | Main Feed Dog Screw No. 22593 | 7 |

LIST OF PARTS

| Symbol to Order By | The figures in the last column refer only to the plates illustrating the parts and are not to be used in ordering. Prices furnished on application. | Plate No. |
|--------------------|---|-----------|
| 8324 L-2 | Throat Plate, for No. 8 gauge Style | |
| | 51600 A- - - - - | 2 |
| 8324 L-4 | " " for No. 12 gauge - - - - - | 2 |
| 8324 L-4 1/2 | " " for No. 16 gauge Style | |
| | 51600 A- - - - - | 2 |
| 8326 | Throat Plate Screw No. 87 | |
| | Differential Feed Dog, for No. 16 gauge | |
| | Style 51600 A - - - | 7 |
| 8326 A | " " " for No. 12 gauge | |
| | Style 51600 A - - - | 7 |
| 8326 G | " " " for No. 10 gauge | |
| | Style 51600 A - - - | 6 |
| | Differential Feed Dog Screw No. 90 | |
| 8328 C-3 | Throat Plate, for No. 10 gauge Style | |
| | 51600 A (screw No. 87) - - - - - | 2 |
| 8344 | Stripper Blade, for Style 51600 A | |
| | (clamp screw No. 187 A, adjusting screw | |
| | No. 28 C) - - - - - | 31 |
| 8372 | Differential Feed Index Adjustable Stop, | |
| | for Styles 51400 AC, 51600 A (screw No. | |
| | 25 CC, washer No. 8372 A) - - - - - | 28 |
| 8372 A | Looper Drive Ball Joint Locking Stud | |
| | Washer; also for Nos. 8372, 23448, | |
| | 51785, K53854, K54264 - - - - - | 26 |
| 9255 | Facing Strip Folder Washer, for Styles | |
| | 51400 B, 51400 D, 51400 Q, 51400 S, | |
| | 51700 D, 51700 K, 51700 R; also for No. | |
| | 23436, K57370 - - - - - | 26 |
| 9271 | Knee Press Shaft Collar (screw No. 98) - - | 50 |
| 9420 C-2 | Presser Foot, for No. 8 gauge Style | |
| | 51600 A- - - - - | 10 |
| 9420 C-3 | " " for No. 10 gauge - - - - - | 10 |
| 9420 C-4 | " " for No. 12 gauge - - - - - | 10 |
| 9420 C-4 1/2 | " " for No. 16 gauge - - - - - | 10 |
| | Presser Foot Clamp Screw No. 91 | |
| 9634 | Presser Foot Yielding Bottom Spring, for | |
| | Styles 51200 G, 51200 R (screw No. | |
| | 57 WD) - - - - - | 32 |
| 9634 A | Presser Foot Yielding Bottom Spring pin, | |
| | for Styles 51200 G, 51200 R - - - - - | 14 |
| 9663 | Attaching Screw, for differential feed | |
| | regulating screw support bracket on | |
| | Style 51200 V - - - - - | 23 |
| 9705 | Feed Dog, for Styles 51200 G, 51200 R | |
| | (screw No. 22528) - - - - - | 8 |
| 9720 | Presser Foot, for Styles 51200 G, 51200 R | |
| | (clamp screw No. 91, yielding bottom | |
| | spring stud No. 57 WD, yielding bottom | |
| | spring No. 9634, yielding bottom spring | |
| | pin No. 9634 A, yielding section No. | |
| | 9663 , detachable toe No. 9735, detach- | |
| | able toe screw No. 605 *) - - - - - | 10 |

LIST OF PARTS

| Symbol to Order By | The figures in the last column refer only to the plates illustrating the parts and are not to be used in ordering. Prices furnished on application. | Plate No. |
|--------------------|--|-----------|
| 9724 | Throat Plate, for Styles 51200 G, 51200 R (screw No. 87)----- | 1 |
| 9733 | Presser Foot Yielding Section, for Styles 51200 G, 51200 R----- | 13 |
| 9735 | Presser Foot Detachable Toe, for Styles 51200 G, 51200 R, (screw No. 605 A)----- | 15 |
| 9937 | Lock Nut, for differential feed control lever, front, on Styles 51200 V, 51400 AC, 51600 A; also for No. 51235 N----- | 25 |
| 11534 | Presser Foot Yielding Section Spring, for Styles 51200 J, 51200 T, (Support screw No. 187 A, attaching screw No. 605)----- | 32 |
| 11635 B | Nut, for presser roller lifter lever stud on Style 51400 G----- | 25 |
| 11638 M | Nut, for main shaft oil gauge on Styles 51200 A, 51200 B, 51200 C, 51200 D, 51200 G, 51200 H, 51200 J, 51200 U, 51200 V, 51400 A, 51400 B, 51400 C, 51400 D, 51400 E, 51400 F, 51400 G, 51400 H, 51400 J, 51400 K, 51400 M, 51400 N, 51400 AC, 51600 A, 51700 C, 51700 D, 51700 E, 51700 F, 51700 G, 51700 H, 51700 T----- | 25 |
| 12538 | Looper Drive Lever Ball Stud Nut----- | 25 |
| 12934 A | Differential Feed Control Link Nut, for Styles 51200 V, 51400 AC, 51600 A; also for No. 52835 D----- | 25 |
| 12957 E | Spring Washer, for binder bracket on Styles 51200 B, 51200 L; also for No. 23449 A----- | 26 |
| 12964 C | Needle Lever Link Pin Ball----- | 19 |
| 12982 | Lock Nut, for presser roller hand lifter lever regulating stud on Style 51400 G; also for No. K57272----- | 25 |
| 12986 B | Pivot Stud, for collapsible folder scroll on Styles 51700 F, 51700 M----- | 20 |
| 12987 A | Nut, for needle lever stud oil cup; also for No. 660-136----- | 25 |
| 12988 A | Plug Screw, for opening in top of bed on Styles 51200 A, 51200 B, 51200 C, 51200 D, 51200 G, 51200 H, 51200 J, 51400 A, 51400 B, 51400 C, 51400 D, 51400 E, 51400 F, 51400 H, 51400 J, 51400 K, 51400 M, 51400 N, 51700 C, 51700 D, 51700 E, 51700 F, 51700 G, 51700 H, 51700 T----- | 21 |
| 12993 A | Screw, for knee press interlocking arm stop on knee press assembly No. 21693 A; also for No. 21693 K----- | 22 |
| 13153 | Main Feed Dog Holder, for Styles 51400 AC, 51600 A (screw No. 93)----- | 17 |
| 14077 | Looper Rocker Ball Stud Nut, for styles in Class 51700----- | 25 |

LIST OF PARTS

| Symbol to Order By | The figures in the last column refer only to the plates illustrating the parts and are not to be used in ordering. Prices furnished on application. | Plate No. |
|--------------------|--|-----------|
| 14090 | Looper Thread Tension Spring, for styles in Class 51700, Styles 51400 A, 51400 B, 51400 C, 51400 D, 51400 E, 51400 F, 51400 H, 51400 J, 51400 K, 51400 M, 51400 N, 51400 P, 51400 Q, 51400 R, 51400 S, 51400 T, 51400 U, 51400 V, 51400 W, 51400 X, 51400 Y, 51400 AA, 51400 AB, 51400 AC, 51600 A - - - - - | 32 |
| 14775 A | Edge Guide Roller Arm Spring, for Styles 51200 D, 51200 N - - - - - | 32 |
| 14786 A | Differential Feed Roll Yoke Support Pin, for Styles 51700 E, 51700 L - - - - - | 29 |
| 15105 B | Main Feed Dog, for No. 8 gauge Style 51600 A (screw No. 22593) - - - - - | 7 |
| 15226 B | Differential Feed Dog, for No. 8 gauge Style 51600 (screw No. 90) - - - - - | 7 |
| 15430 C | Needle Lever Connecting Rod Nut, left thread; also for Nos. 21708, 21708 C - - - - - | 25 |
| 15430 D | Needle Lever Connecting Rod Nut, right thread; also for Nos. 21693 J, 21708 - - - - - | 25 |
| 15438 D | Differential Feed Intermediate Gear Stud, for Styles 51700 E, 51700 L (nut No. 43443 Q) - - - - - | 22 |
| 15465 F | Looper Rocker Cone (screw No. 88, nut No. 258 A) - - - - - | 28 |
| 15872 D | Pivot Stud, for top roller feed support on Styles 51200 U, 51200 V - - - - - | 22 |
| 15872 F | Lifter Lever Spring, for Styles 51200 U, 51200 V, 51400 AC, 51600 A, 51700 T - - - - - | 32 |
| 16152-56 | Needle Holder, for No. 56 gauge styles in Class 51700 - - - - - | 17 |
| 16152-72 | Needle Holder, for No. 72 gauge - - - - - | 17 |
| 16152-80 | " " for No. 80 gauge - - - - - | 17 |
| 16152-88 | " " for No. 88 gauge - - - - - | 17 |
| 16152-96 | " " for No. 96 gauge - - - - - | 17 |
| 16152-128 | " " for No. 128 gauge - - - - - | 17 |
| | Needle Holder Spot Screw No. 89 | |
| | Needle Set Screw No. 98 | |
| 16164 | Tension Post Ferrule, for strip tension on Styles 51400 D, 51400 G, 51400 S, 51700 D, 51700 K, 51700 T, 51700 U - - - - - | 26 |
| 16182 B | Needle Stop Plate, for No. 96 gauge styles in Class 51700 - - - - - | 39 |
| 16182 C | " " " for No. 128 gauge styles in Class 51700 - - - - - | 39 |
| | Needle Stop Plate screw No. 605 | |
| 16194 | Presser Foot Yielding Section Spring, for Styles 51400 M, 51400 AA, 51700 F, 51700 G, 51700 H, Nos. 32 and 40 gauge Style 51700 L, Styles 51700 M, 51700 N, 51700 P, 51700 T, 51700 U (attaching screw No. 605, adjusting screw No. 605 A) - - - - - | 32 |

LIST OF PARTS

| Symbol to Order By | The figures in the last column refer only to the plates illustrating the parts and are not to be used in ordering. Prices furnished on application. | Plate No. |
|--------------------|---|-----------|
| 16194 B | Presser Foot Strip Guide, for Styles 51700 G, 51700 H, 51700 N, 51700 P (screw No. 73 A) | 15 |
| 16241 | Spring, for tilting right section of presser foot on Styles 51700 F, 51700 M, 51700 T, 51700 U (screw No. 604) - - - - - | 32 |
| 16241 A | Spring, for tilting left section of presser foot on Styles 51700 F, 51700 M, 51700 T, 51700 U (screw No. 605) - - - - - | 32 |
| 16505-88 | Feed Dog, for No. 88 gauge Styles 51700 F, 51700 M - - - - - | 9 |
| 16505-96 | Feed Dog, for No. 96 gauge Styles 51700 T, 51700 U - - - - - | 9 |
| 16524 B-88 | Feed Dog Screw No. 22528 | |
| 16524 B-88 | Throat Plate, for No. 88 gauge Styles 51700 F, 51700 M - - - - - | 2 |
| 16524 B-96 | Throat Plate, for No. 96 gauge Styles 51700 T, 51700 U - - - - - | 2 |
| 16527 B-88 | Throat Plate Screw No. 87 | |
| | Presser Foot, for No. 88 gauge Styles 51700 F, 51700 M (set screw No. 22570, yielding section spring No. 16194, yielding section spring attaching screw No. 605, yielding section spring adjusting screw No. 605 A, right section tilting spring No. 16241, right section tilting spring screw No. 604, left section tilting spring No. 16241 A, left section tilting spring screw No. 605) - - - - - | 12 |
| 16675 | Edge Guide Roller, for Styles 51700 D, 51700 N - - - - - | 26 |
| 16676 | Edge Guide Roller Pin, for Styles 51700 D, 51700 N - - - - - | 29 |
| 16868 | Looper Connecting Rod, for No. 56 gauge styles in Class 51700 (nut, right thread, No. 18, nut, left thread, No. 269 - - - - - | 46 |
| 21101 G-2 | Thread Stand Assembly, Style G, for use with two cones; one each Nos. 21114 D-2, 21104 B-24, 21104 H, 21114 A, 21114 H-2, 21114 S-2, 21114 T, 22810; two each Nos. 21114 U, 21114 W; three No. 652-16; four No. 258 A; six No. 21114 V - - - - - | 62 |
| 21101 G-4 | Thread Stand Assembly, Style G for use with three and four cones; one each Nos. 21114 D-4, 21104 B-24, 21104 H, 21114 A, 21114 H-4, 21114 S-4, 21114 T, 22810; two No. 21114 U; four No. 21114 W; five No. 652-16; eight No. 258 A; twelve No. 21114 V - - - - - | 63 |

LIST OF PARTS

| Symbol to Order By | The figures in the last column refer only to the plates illustrating the parts and are not to be used in ordering. Prices furnished on application. | Plate No. |
|--------------------------|--|--------------|
| 21101 H-2 | Thread Stand Assembly, Style "H", for use with two spools; one each Nos. 21114 D-2, 21104 B-24, 21104 H, 21114 A, 21114 H-2, 21114 S-2, 21114 T, 22810, two each Nos. 21104 V, 21114, 21114 U, 21114 W, three No. 652-16, four No. 258 A - - - - - | 62 |
| 21101 H-4 | Thread Stand Assembly, Style "H", for use with three and four spools; one each Nos. 21114 D-4, 21104 B-24, 21104 H, 21114 A, 21114 H-4, 21114 S-4, 21114 T, 22810: two No. 21114 U; four each Nos. 21104 V, 21114, 21114 W; five No. 652-16; eight No. 258 A - | 63 |
| 21104 B-2 | Piping Cord Stand Rod, 2 inches long, for Styles 51700 G, 51700 H, 51700 N, 51700 P - | 53 |
| 21104 B-11 | Thread Stand Rod, 11 inches long, for Style "C" thread stands; also upper tape reel support rod and piping cord stand rod - - - | 53 |
| 21104 B-14 | Upper Tape Reel Support Rod, 14 inches long, for Styles 51700 G, 51700 H, 51700 N, 51700 P - - - - - | 53 |
| 21104 B-20 | Upper Tape Reel Support Rod, 20 inches long, for styles in Class 51700 - - - - - | 53 |
| 21104 B-24 | Thread Stand Rod, 24 inches long, for Styles "G" and "H" thread stands (set screw No. 22591) - - - - - | 53 |
| 21104 C | Piping Cord Stand Connection, for Styles 51700 G, 51700 H, 51700 N, 51700 P (screw No. 22509) - - - - - | 49 |
| 21104 D | Piping Cord Spool Seat, for Styles 51700 G, 51700 H, 51700 N, 51700 P - - - - - | 64 |
| 21104 E | Piping Cord Spool Seat Connection, for Styles 51700 G, 51700 H, 51700 N, 51700 P - - - - - | 49 |
| 21104 F | Piping Cord Spool Seat Pad, for Styles 51700 G, 51700 H, 51700 N, 51700 P - - - - - | 64 |
| 21104 G | Piping Cord Spool Pin, for Styles 51700 G, 51700 H, 51700 N, 51700 P - - - - - | 61 |
| 21104 H | Piping Cord Spool Pin Nut, for Styles 51700 G, 51700 H, 51700 N, 51700 P; also for No. 21114 U - - - - - | 25 |
| 21104 K | Piping Cord Guide Wire, for Styles 51700 G, 51700 H, 51700 N, 51700 P (screw No. 22632 F-24) - - - - - | 64 |
| 21104 V | Felt Pad, 5 1/4 inches diameter, for spool seat disc on Style "H" thread stand - - - | 63 |
| 21105 J | Piping Cord Stand Cord Guide, for Styles 51700 G, 51700 H, 51700 N, 51700 P - - - - | 18 |
| 21113 A | Thread Stand Wire Extension, 6 inches long, on Style "C" thread stands (set screw No. 22632 F-24) - - - - - | 45 |
| 21113 B | Thread Stand Wire Coupling on Style "C" thread stands (screw No. 88) - - - - - | 27 |

LIST OF PARTS

| Symbol to Order By | The figures in the last column refer only to the plates illustrating the parts and are not to be used in ordering. Prices furnished on application. | Plate No. |
|--------------------|--|-----------|
| 21114 | Spool Disc Seat, for Style "H" thread stand | 63 |
| 21114 A | Thread Stand Base; also upper tape reel support base (set screw No. 22591)- - - - | 61 |
| 21114 D-2 | Seat, for two cones on Style "G" and "H" thread stands - - - - - | 62 |
| 21114 D-4 | Seat, for four cones on Styles "G" and "H" thread stands - - - - - | 63 |
| | Seat Screws No. 22591 A | |
| 21114 H-2 | Eyelet Support, for two cones on Style "G" and "H" thread stands - - - - - | 62 |
| 21114 H-4 | Eyelet Support, for four cones on Styles "G" and "H" thread stands - - - - - | 62 |
| | Eyelet Support Screws No. 22591 A - | |
| 21114 K | Insert Gasket, for eyelet support on Styles "G" and "H" thread stands - - - - - | 63 |
| 21114 S-2 | Lead Eyelet, adjustable, for two cones on Styles "G" and "H" thread stands (insert No. 668-1, insert locking ferrule No. 668-14, insert gasket No. 21114 K)- - - - | 62 |
| 21114 S-4 | Lead Eyelet, adjustable, for four cones on Styles "G" and "H" thread stands- - - - - | 63 |
| 21114 T | Lead Eyelet Socket Ball, for Styles "G" and "H" thread stands (screw No. 22591) - - - - | 63 |
| 21114 U | Lead Eyelet Ball Split Socket, half section for Styles "G" and "H" thread stands (clamp screw No. 22810, nut No. 21104 H, washer No. 652-16)- - - - - | 63 |
| 21114 V | Cone Holder Spring, for Style "G" thread stand - - - - - | 63 |
| 21114 W | Spool Pin, for Styles "G" and "H" thread stands (nut No. 258 A)- - - - - | 63 |
| 21130 A-2 | Thread Stand Seat, two spools, on Style "C" thread stands - - - - - | 64 |
| 21130 A-4 | Thread Stand Seat, four spools, on Style "C" thread stands - - - - - | 64 |
| 21145 | Cone, wood, for thread stands- - - - - | 50 |
| 21157 | Upper Tape Reel Disc, 8 inches diameter - - | 64 |
| 21169 E | Binding holder disc - - - - - | 64 |
| 21169 F | Binding Holder Base - - - - - | 64 |
| 21172 E | Piping Strip Holder Disc, right, for Styles 51700 G, 51700 H, 51700 N, 51700 P- - - - | 64 |
| 21172 F | Piping Strip Holder Disc, left, for Styles 51700 G, 51700 H, 51700 N, 51700 P (thumbscrew No. 25 T)- - - - - | 64 |
| 21172 J | Piping Strip Guide and Tension, for Styles 51700 G, 51700 H, 51700 N, 51700 P (set screw No. 88) - - - - - | 50 |
| 21172 K | Piping Strip Guide and Tension Support, for Styles 51700 G, 51700 H, 51700 N, 51700 P (set screw No. 88)- - - - - | 50 |

LIST OF PARTS

| Symbol to Order By | The figures in the last column refer only to the plates illustrating the parts and are not to be used in ordering. Prices furnished on application. | Plate No. |
|--------------------|--|-----------|
| 21172 L | Piping Strip Disc Tension Spring Hub, for Styles 51700 G, 51700 H, 51700 N, 51700 P (thumbscrew No. 25 T)- - - - - | 30 |
| 21172 M | Piping Strip Disc Supporting Rod Holder, for Styles 51700 G, 51700 H, 51700 N, 51700 P- | 53 |
| 21172 N | Piping Strip Holder Disc Axle, for Styles 51700 G, 51700 H, 51700 N, 51700 P - - - - | 53 |
| 21173 A | Vertical Rod Support, for upper tape reel support (screw No. 22507)- - - - - | 61 |
| 21173 B | Horizontal Rod Connection, for upper tape reel support (screw No. 22508) - - - - - | 64 |
| 21178 | Tape Reel Disc, 8 inches diameter, for Styles 51400 B, 51400 C, 51400 D, 51400 Q, 51400 R, 51400 S, 51700 C, 51700 D, 51700 E, 51700 G, 51700 H, 51700 J, 51700 K, 51700 L, 51700 N, 51700 P, 51700 R, 51700 S - - - - - | 64 |
| 21182 K | Strip Tension Plate, outer, for Styles 51400 D, 51400 G, 51400 S, 51700 D, 51700 K, 51700 T, 51700 U- - - - - | 38 |
| 21182 L | Strip Tension Plate, inner, for Styles 51400 D, 51400 S, 51700 D, 51700 K, 51700 T, 51700 U - - - - - | 38 |
| 21182 N | Strip Tension Assembly, for Styles 51400 D, 51400 S, 51700 D, 51700 K, 51700 T, 51700 U; one each Nos. 21182 K, 21182 L, 21182 P; two each Nos. 107, 108, 110-3, 1346, 16164- - - - - | 38 |
| 21182 P | Strip Tension Base, for Styles 51400 D, 51400 G, 51400 S, 51700 D, 51700 K, 51700 T, 51700 U - - - - - | 38 |
| 21182 T | Strip Tension Assembly, for Style 51400 G; one each Nos. 21182 K, 21182 P; two each Nos. 107, 108, 110-3, 1346, 16164- - - - - | 38 |
| 21201 | Screw Driver, 9/64 inch round blade, length overall 7 5/8 inches - - - - - | 59 |
| 21202 | " " 7/32 inch round blade, length overall 11 1/4 inches- - - - - | 59 |
| 21203 | " " 13/64 inch round blade, length overall 15 1/2 inches- - - - - | 59 |
| 21204 | " " 9/32 inch round blade, length overall 15 inches- - - - - | 59 |
| 21205 A | " " 3/8 inch round blade, length overall 14 inches- - - - - | 59 |
| 21207 | " " 7/64 inch round blade, length overall 2 1/2 inches - - - - - | 51 |
| 21208 | Screw Driver Set, three detachable blades- - - - - | 59 |
| 21210 | Looper Collar, .040 inch thick - - - - - | 26 |
| 21210 A | " " .020 inch thick - - - - - | 26 |
| 21211 | " " .054 inch thick - - - - - | 26 |
| 21225-1/8 | Looper Adjusting Gauge, 1/8 inch measurement | 31 |

LIST OF PARTS

| Symbol to Order By | The figures in the last column refer only to the plates illustrating the parts and are not to be used in ordering. Prices furnished on application. | Plate No. |
|--------------------------|---|--------------|
| 21225-5/32 | Looper Adjusting Gauge, 5/32 inch measure- ment- - - - - | 31 |
| 21227 R | Gauge, for synchronizing looper and needle motions on machines with throat plates 2 1/4 inches long, component parts are shipped in leather case - - - - - | 51 |
| 21227 AC | Gauge, for synchronizing looper and needle motions on machines with throat plates 3 1/8 inches long, component parts are shipped in leather case - - - - - | 51 |
| 21227 HH | Eyelet Replacement Tool Set, for assembling 1/16 inch internal diameter eyelet No. 668-7 and ferrule No. 668-12 in tension thread eyelet assembly. Ferrule should always be replaced- - - - - | 51 |
| 21227 HK | Insert Replacement Tool Set, for assembling 1/8 inch internal diameter inserts No. 668-1 and ferrules No. 668-14 in thread lead-in eyelet assembly; also for Nos. 21114 H-2, 21114 H-4, 21114 S-2, 21114 S-4 Ferrules should always be replaced- - - - - | 51 |
| 21233 N | Connector, with BX cable for D.C. "Electro Drives" - - - - - | 51 |
| 21233 P | Connector, with BX cable for single and three phase A.C. "Electro Drives" - - - - - | --- |
| 21233 X | Light Fixture Assembly, including bulb and blue lens, table mounting, for machines driven by "Electro Drive" - - - - - | --- |
| 21233 Y | Light Fixture Assembly, including bulb and clear lens- - - - - | --- |
| 21233 Z | Light Fixture Assembly, including bulb, but without lens- - - - - | --- |
| 21236 | Belt Plier, for 3/8 inch and smaller round belting - - - - - | 59 |
| 21260 | Emery Cord, 3/64 inch diameter, grade No. 120, fifty yard spool- - - - - | --- |
| 21260 A | Emery Cord, 3/64 inch diameter, grade No. 150, fifty yard spool - - - - - | --- |
| 21260 B | Emery Cord, 1/32 inch diameter, grade No. 180, fifty yard spool - - - - - | --- |
| 21260 C | Emery Cord, .025 inch diameter, grade No. 200, fifty yard spool - - - - - | --- |
| 21260 D | Emery Tape, 3/32 inch wide, grade No. 180, fifty yard spool- - - - - | --- |
| 21260 E | Emery Cord, .018 inch diameter, grade No. 200, fifty yard spool - - - - - | --- |
| 21261 | Leather Belt, flat, 1 inch wide, 63 inches long, includes belt fastener No. 21350- - | --- |
| 21262 | Leather Belt, round, 9/32 inch diameter, 44 inches long, includes wire belt hook No. 21351 - - - - - | --- |

LIST OF PARTS

| Symbol to Order By | The figures in the last column refer only to the plates illustrating the parts and are not to be used in ordering. Prices furnished on application. | Plate No. |
|--------------------|---|-----------|
| 21262 H-340 | "V" Belt, No. 2 size, 34 inches outside circumference - - - - - | 53 |
| 21262 H-350 | "V" Belt 35 inches outside circumference - | 53 |
| 21262 H-370 | " " 37 inches outside circumference - | 53 |
| 21262 H-380 | " " 38 inches outside circumference - | 53 |
| 21300 C-5 3/4 | Carriage Bolt, countersunk head, 3/8 x 5 3/4 inches, for table tops - - - - - | - |
| 21350 | Belt Fastener, malleable iron, for 1 inch flat belt - - - - - | 31 |
| 21351 | Belt Hook, wire, for 9/32 inch round belt - | 31 |
| 21355 | Chair Leg Extension, 4 inches long - - - - | 49 |
| 21375 AH | Pulley Guard (screw No. 93) - - - - - | 57 |
| 21385 B | Lower Tape Reel Axle, for Styles 51400 B, 51400 C, 51400 D, 51400 Q, 51400 R, 51400 S, 51700 C, 51700 D, 51700 E, 51700 J, 51700 K, 51700 L (thumbscrew No. 201 C) - - - - - | 64 |
| 21388 | Wrench, single end, 3/8 inch opening - - - | 50 |
| 21388 N | " double end, 3/16 and 5/16 inch openings - - - - - | 50 |
| 21388 R | " double end, 3/8 and 1/2 inch openings - - - - - | 50 |
| 21388 X | " for main shaft bearing housing - - | 64 |
| 21388 Z | " for setting needle lever stud with respect to oil groove. Stud is set correctly when the pin hole nearest the periphery is up and a line drawn between the two pin holes is 45 degrees to the right of the vertical - - - - - | 51 |
| 21388 AE | Socket Wrench Assembly, for 9/32 inch and 3/8 inch hexagonal nuts, for looper lever ball stud locking stud and tilting feed mechanism - - - - - | 51 |
| 21394 | Utility Grinder, including emery wheel, 5 inches diameter, 1/4 inch face, round belt drive, recommended speed 3000 R.P.M. - - - - - | - |
| 21394 G | Emery Wheel, 5 inches diameter, 1/4 face, 3/8 inch hole, grade "M" emery 60 - | - |
| 21394 H | Emery Wheel, 5 inches diameter, 1/2 inch face, 3/8 inch hole, grade "M" emery 60 - - - - - | - |
| 21394 K | Utility Grinder, including emery wheel, 5 inches diameter, 1/2 inch face, round belt drive, recommended speed 3000 R.P.M. - - - - - | - |
| 21657-2 | Tension Release Disc Separator, for styles in Class 51200, Style 51400 G - - - | 39 |

LIST OF PARTS

| Symbol to Order By | The figures in the last column refer only to the plates illustrating the parts and are not to be used in ordering. Prices furnished on application. | Plate No. |
|--------------------|---|-----------|
| 21657-4 | Tension Release Disc Separator, for styles in Class 51700, Styles 51400 A, 51400 B, 51400 C, 51400 D, 51400 E, 51400 F, 51400 H, 51400 J, 51400 K, 51400 M, 51400 N, 51400 P, 51400 Q, 51400 R, 51400 S, 51400 T, 51400 U, 51400 V, 51400 W, 51400 X, 51400 Y, 51400 AA, 51400 AB, 51400 AC, 51600 A- - - - - | 39 |
| 21657 A | Tension Release Rock Shaft, for Styles 51200 A, 51200 B, 51200 C, 51200 D, 51200 G, 51200 H, 51200 J, 51200 U, 51200 V, 51400 A, 51400 B, 51400 C, 51400 D, 51400 E, 51400 F, 51400 G, 51400 H, 51400 J, 51400 K, 51400 M, 51400 N, 51400 AC, 51600 A, 51700 C, 51700 D, 51700 E, 51700 F, 51700 G, 51700 H, 51700 T- - - - - | 45 |
| 21657 B | Tension Release Rock Shaft Connection, clamp screw No. 22585- - - - - | 31 |
| 21657 C | Tension Release Rock Shaft Lever (clamp screw No. 22596, stud No. 22594) - - - - - | 39 |
| 21657 D | Tension Release Rock Shaft Lever Link, for Styles 51200 A, 51200 B, 51200 C, 51200 D, 51200 G, 51200 H, 51200 J, 51400 A, 51400 B, 51400 C, 51400 D, 51400 E, 51400 F, 51400 G, 51400 H, 51400 J, 51400 K, 51400 M, 51400 N, 51700 C, 51700 D, 51700 E, 51700 F, 51700 G, 51700 H, (stud No. 22515) - - - - - | 39 |
| 21657 E | Cast-off Plate Support Washer- - - - - | 26 |
| 21657 J | Tension Release Rock Shaft Connection Link, for Styles 51200 U, 51200 V, 51400 AC, 51600 A, 51700 T - - - - - | 39 |
| 21657 L | Tension Release Rock Shaft, for Styles 51200 K, 51200 L, 51200 M, 51200 N, 51200 R, 51200 S, 51200 T, 51400 P, 51400 Q, 51400 R, 51400 S, 51400 T, 51400 U, 51400 V, 51400 W, 51400 X, 51400 Y, 51400 AA, 51400 AB, 51700 J, 51700 K, 51700 L, 51700 M, 51700 N, 51700 P, 51700 Q, 51700 R, 51700 U- - - - - | 45 |
| 21657 M | Tension Release Rock Shaft Lever Link, for Styles 51200 K, 51200 L, 51200 M, 51200 N, 51200 R, 51200 S, 51200 T, 51400 P, 51400 Q, 51400 R, 51400 S, 51400 T, 51400 U, 51400 V, 51400 W, 51400 X, 51400 Y, 51400 AA, 51400 AB, 51700 J, 51700 K, 51700 L, 51700 M, 51700 N, 51700 P, 51700 Q, 51700 R, 51700 U - - - - - | 39 |
| 21657 P | Tension Release Rock Shaft Bushing, for Styles 51200 K, 51200 L, 51200 M, 51200 N, 51200 R, 51200 S, 51200 T, 51400 P, 51400 Q, 51400 R, 51400 S, 51400 T, 51400 U, 51400 V, 51400 W, 51400 X, 51400 Y, 51400 AA, 51400 AB, 51700 J, 51700 K, 51700 L, 51700 M, 51700 N, 51700 P, 51700 Q, 51700 R, 51700 U- - - - - | 45 |

LIST OF PARTS

| Symbol to Order By | The figures in the last column refer only to the plates illustrating the parts and are not to be used in ordering. Prices furnished on application. | Plate No. |
|--------------------------|---|--------------|
| 21660 A | Knee Press Assembly, for Style 51700 M; one each Nos. 21661, 21662, 21663, 21663 A, 21664; two each Nos. 98, 9271, 21665; five No. 69 FD- | 52 |
| 21661 | Knee Press Shaft, for assembly No. 21660 A - - | 52 |
| 21662 | " " Shaft Hanger, for assembly No. 21660 A - - - - - | 52 |
| 21663 | " " Plate Rod, for assembly No. 21660 A - | 52 |
| 21663 A | " " Lever, for assembly No. 21660 A - - | 52 |
| 21664 | " " Plate, for assembly No. 21660 A (screw No. 69 FD) - - - - - | 52 |
| 21665 | " " Plate Rod Connection, for assembly No. 21660 A; also for No. 21663 A (screw No. 69 FD) - - - - - | 52 |
| 21680 AK | Base Plate, for nonsubmerged and semisubmerged installations on six isolators - - - - - | 61 |
| 21685 | Knee Press Plate, for assembly No. 21693A- - - | 52 |
| 21692 | " " Chain, 18 1/2 inches long, for Style 51200 N - - - - - | 52 |
| 21693 A | " " Assembly, for Style 51200 N; one each Nos. 15430 D, 21685, 21693 B, 21693 C, 21693 D, 21693 F, 21693 G, 21693 H, 21693 J, 21693 K, 21693 T, 22622; two each Nos. 34, 650-10, 12993 A; three No. 69 FD and four No. 28577- - - - - | 64 |
| 21693 B | Knee Press Shaft, for assembly No. 21693 A - - | 61 |
| 21693 C | " " Shaft Bracket, front, for assembly No. 21693 A - - - - - | 52 |
| 21693 D | " " Shaft Bracket, rear, for assembly No. 21693 A (bolt No. 650-10, compensating washer No. 28577)- - - | 50 |
| 21693 F | Knee Press Interlocking Forked Arm, for assembly No. 21693 A (set screw No. 69 FD) - | 50 |
| 21693 G | Knee Press Interlocking Arm, with engaging pin, for assembly No. 21693 A (set screw No. 22622, stop screw No. 12993 A lock nut No. 34) - - - - - | 50 |
| 21693 H | Knee Press Interlocking Arm Pivot Pin, 1 5/8 inches long, for assembly No. 21693 A- - - - | 30 |
| 21693 J | Knee Press Plate Rod, for assembly No. 21693 A (lock nut No. 15430 D) - - - - - | 52 |
| 21693 K | Knee Press Chain Arm, for assembly No. 21693 A (set screw No. 69 FD, stop screw No. 12993 A, lock nut No. 34)- - - - - | 50 |
| 21693 T | Knee Press Shaft Hanger Spacing Block, for assembly No. 21693 A - - - - - | 50 |
| 21697 AA | Belt Take-up and Hanger Assembly, for "V" belt installations- - - - - | 61 |
| 21698-2 | Vibration Insulator, two inches long, for tables - - - - - | 51 |
| 21698-4 | Vibration Insulator, four inches long- - - - | 51 |
| 21698-5 | " " five inches long- - - - | 51 |

LIST OF PARTS

| Symbol to Order By | The figures in the last column refer only to the plates illustrating the parts and are not to be used in ordering. Prices furnished on application. | Plate No. |
|--------------------|--|-----------|
| 21698-6 | Vibration Insulator, six inches long- - - - - NOTE: Special lengths will be furnished on request. Part of the table leg is shown in the illustration for clarity. | 51 |
| 21701 A | Base Plate, for machines equipped with Class 21700 puller- - - - - | - |
| 21708 | Puller Driving Eccentric Connecting Rod, for Styles 51700 F, 51700 G, 51700 T (nut, left thread, No. 15430 C, nut, right thread, No. 15430 D)- - - - - | 46 |
| 21708 B | Puller Driving Eccentric Connecting Rod, for Style 51400 G (nut, right thread, No. 18, nut, left thread No. 269) - - - - - | 46 |
| 21708 C | Puller Driving Eccentric Connecting Rod Tube, for Styles 51700 M, 51700 N, 51700 U, (nut large, No. 15430 C, nut, small, No. 269)- - - - - | 46 |
| 21723 C | Puller Presser Roller Axle, for Style 51400 G - - - - - | 45 |
| 21724 A | " " " " Spring - - - - - | 32 |
| 21725 | " " " " Screw- - - - - | 24 |
| 22504 | Screw, for guide leading strip to feed dog on Styles 51700 E, 51700 L - - - - - | 23 |
| 22507 | Set Screw, square head, cup point, 1/4 inch diameter, 20 threads per inch, 3/8 inch long for upper tape reel support vertical connection- - - - - | 22 |
| 22508 | Set screw, square head, cup point, 1/4 inch diameter, 20 threads per inch, 1/2 inch long, for upper tape reel post; also for No. 21173 B - - - - - | 22 |
| 22509 | Set Screw, square head, cup point, 5/16 inch diameter, 18 threads per inch, 1/2 inch long, for piping cord stand connection- - - - - | 22 |
| 22513 | Screw, for presser bar connection guide plate; also for No. K59503 - - - - - | 21 |
| 22515 | Stud, for tension release rock shaft lever link- - - - - | 21 |
| 22516 | Screw, for feed rocker segment slot plate on Styles 51200 V, 51400 AC, 51600 A - - - - - | 21 |
| 22517 | Screw, for puller connecting rod guard on Style 51400 G - - - - - | 23 |
| 22519 | Set Screw, hexagonal head, for needle lever ball stud on Styles 51200 A, 51200 B, 51200 C, 51200 D, 51200 G, 51200 H, 51200 J, 51200 U, 51200 V - - - - - | 21 |
| 22519 C | Clamp Screw, for feed rocker arm- - - - - | 21 |
| 22521 | Screw, plus size for cloth plate (tap V118) - - - - - | 22 |

LIST OF PARTS

| Symbol to Order By | The figures in the last column refer only to the plates illustrating the parts and are not to be used in ordering. Prices furnished on application. | Plate No. |
|--------------------|---|-----------|
| 22524 | Screw, countersunk head, for oil reservoir top cover on Styles 51200 K, 51200 L, 51200 M, 51200 N, 51200 R, 51200 S, 51200 T, 51400 P, 51400 Q, 51400 R, 51400 S, 51400 T, 51400 U, 51400 V, 51400 W, 51400 X, 51400 Y, 51400 AA, 51400 AB, 51700 J, 51700 K, 51700 L, 51700 M, 51700 N, 51700 P, 51700 Q, 51700 R, 51700 U - - | 22 |
| 22528 | Screw, for feed dogs; also for Nos. 23229 P, 51243 B, 51457 A, 51757 A, 52857 B - - - - - | 21 |
| 22532 | Stripper Blade Adjusting Stud, for body folder on Styles 51700 E, 51700 L - - - - - | 24 |
| 22539 A | Plug Screw, for looper drive lever shaft hole on Styles 51200 K, 51200 L, 51200 M, 51200 N, 51200 R, 51200 S, 51200 T, 51400 P, 51400 Q, 51400 R, 51400 S, 51400 T, 51400 U, 51400 V, 51400 W, 51400 X, 51400 Y, 51400 AA, 51400 AB, 51700 J, 51700 K, 51700 L, 51700 M, 51700 N, 51700 P, 51700 Q, 51700 R, 51700 U - - - - - | 24 |
| 22539 C | Plug Screw, for bolt hole in cloth plates - - - - - | 24 |
| 22542 | Screw, for presser roller lifter lever angle plate on Style 51400 G - - - - - | 21 |
| 22548 | Screw, for facing folder on Styles 51200 V, 51400 B, 51400 D, 51400 Q, 51400 S, 51700 D, 51700 E, 51700 K, 51700 L, 51700 R, 51700 T, 51700 U; also for Nos. 23293 N, 23435, 23439 B, 23447 B - - - - - | 21 |
| 22557 | Screw, for collapsible folder lever on Styles 51700 F, 51700 M - - - - - | 23 |
| 22559 A | Bearing Screw, lower, for Nos. 29105 L, 29105 M, 29105 P, 29105 Q - - - - - | 23 |
| 22559 B | Bearing Screw, upper, for Nos. 29105 L, 29105 M, 29105 P, 29105 Q - - - - - | 23 |
| 22559 C | Bearing Screw, for puller driving eccentric connection on Styles 51400 G, 51700 M, 51700 N, 51700 U; also for feed clutch driving eccentric connection on Styles 51200 U, 51200 V - - - - - | 23 |
| 22560 | Screw, for needle lever link pin - - - - - | 20 |
| 22560 A | Set Screw, for roller feed clutch stationary lever locking pin on Styles 51200 U, 51200 V | 20 |
| 22560 B | Set Screw, Headless, for feed bar; also for Nos. HA1286, 51462 B, 51751 - - - - - | 20 |
| 22561 | Screw, for upper folder on Style 51600 A; also for Nos. K58111, K60416, K60418 - - - - - | 20 |
| 22562 | Screw, for folder swinging arm latch on Styles 51200 U, 51200 V - - - - - | 21 |
| 22565 C | Screw, for lower differential feed roll on Styles 51700 E, 51700 L - - - - - | 20 |

LIST OF PARTS

| Symbol to Order By | The figures in the last column refer only to the plates illustrating the parts and are not to be used in ordering. Prices furnished on application. | Plate No. |
|--------------------|---|-----------|
| 22566 A | Stud, for lifter lever on Styles 51200 K, 51200 L, 51200 M, 51200 N, 51200 R, 51200 S, 51200 T, 51400 P, 51400 Q, 51400 R, 51400 S, 51400 T, 51400 U, 51400 V, 51400 W, 51400 X, 51400 Y, 51400 AA, 51400 AB, 51700 J, 51700 K, 51700 L, 51700 M, 51700 N, 51700 P, 51700 Q, 51700 R, 51700 U - - - - - | 24 |
| 22566 C | Stud, for lifter lever on Styles 51200 A, 51200 B, 51200 C, 51200 D, 51200 G, 51200 H, 51200 J, 51200 U, 51200 V, 51400 A, 51400 B, 51400 C, 51400 D, 51400 E, 51400 F, 51400 G, 51400 H, 51400 J, 51400 K, 51400 M, 51400 N, 51400 AC, 51600 A, 51700 C, 51700 D, 51700 E, 51700 F, 51700 G, 51700 H, 51700 T - - - - - | 24 |
| 22567 | Screw, for folder support bracket on Style 51200 V - - - - - | 21 |
| 22569 | " for feed crank link; also for No. 51245 - - - - - | 23 |
| 22569 B | " for main shaft bearing housing - - - - - | 21 |
| 22570 | " fillister head for throat plates; also for Nos. 16527 B-88, K55764 - - - - - | 21 |
| 22571 A | Plug Screw, for spring pressed felt wick on main shaft bearings; also for oil drain hole in crankshaft chamber - - - - - | 20 |
| 22574 | Screw, 2 1/32 inch long, for cloth plates; also for No. 52880 - - - - - | 22 |
| 22580 | Set Screw, for shielded disc take-up; also for Nos. 51239 E, 51239 G - - - - - | 20 |
| 22581 | Screw, for differential feed roll yoke support on Styles 51700 E, 51700 L - - - - - | 21 |
| 22585 | Clamp Screw, for tension release rock shaft connection; also for Nos. 23437 B, 52894 J - - - - - | 21 |
| 22585 A | Screw, fillister head, for oil reservoir top cover on Styles 51200 K, 51200 L, 51200 M, 51200 N, 51200 R, 51200 S, 51200 T, 51400 P, 51400 Q, 51400 R, 51400 S, 51400 T, 51400 U, 51400 V, 51400 W, 51400 X, 51400 Y, 51400 AA, 51400 AB, 51700 J, 51700 K, 51700 L, 51700 M, 51700 N, 51700 P, 51700 Q, 51700 R, 51700 U - - - - - | 22 |
| 22585 B | Screw, for needle rear guard - - - - - | 22 |
| 22586 | Plug Screw, for puller eccentric bearing on Styles 51400 G, 51700 M, 51700 N, 51700 U; also for Nos. 29114 A, 29114 B - - - - - | 20 |
| 22586 B | Plug Screw, for center bearing lug on Style 51200 U - - - - - | 20 |
| 22587 | Screw, for puller drive eccentric bearing on Styles 51700 F, 51700 G, 51700 T - - - - - | 23 |
| 22591 | Set Screw, for thread stand rod; also for No. 21114 T - - - - - | 20 |
| 22591 A | Set Screw, for thread stand cone seat; also for No. 21114 H - - - - - | 20 |

LIST OF PARTS

| Symbol to Order By | The figures in the last column refer only to the plates illustrating the parts and are not to be used in ordering. Prices furnished on application. | Plate No. |
|--------------------|---|-----------|
| 22593 | Screw, for main feed dog on Styles 51200 V, 51400 AC, 51600 A; also for Nos. 23447 A, 23447 C, 39237 D- - - - - | 22 |
| 22594 | Stud, for tension release rock shaft lever- - | 23 |
| 22596 | Clamp Screw, for tension release rock shaft lever; also for No. 43294 A - - - - - | 21 |
| 22597 | Spot Screw, for pulley; also for Nos. 7490 P, 52835 U, 52835 W- - - - - | 20 |
| 22597 A | Folder Clamp Screw, for Style 51200 V; also for Nos. 51221, 51242 A, 51242 B, 51321 A, 51321 B - - - - - | 20 |
| 22622 | Set Screw, for knee press interlocking arm on assembly No. 21693 A - - - - - | 20 |
| 22632 F-24 | Set Screw, flat head, cup point, 3/16 inch diameter, 3/8 inch long, 24 threads per inch, for thread stand wires; also for Nos. 21104 K, 21113 A- - - - - | 22 |
| 22637 A | Screw, 1 1/2 inches long for fastening machine to puller base plate on Styles 51700 F, 51700 G, 51700 M, 51700 N, 51700 T, 51700 U- - - - - | 25 |
| 22637 B | Screw, 2 1/2 inches long for fastening machine to puller base plate on Styles 51700 F, 51700 G, 51700 M, 51700 N, 51700 T, 51700 U- - - - - | 25 |
| 22637 D | Screw, 1 3/4 inches long for fastening machine to puller base plate on Styles 51700 F, 51700 G, 51700 M, 51700 N, 51700 T, 51700 U- - - - - | 25 |
| 22704 | Screw, for clutch roller spring on Styles 51200 U, 51200 V, 51400 G - - - - - | 20 |
| 22711 | Screw, for cloth plate end cover spring on Styles 51200 U, 51200 V, 51400 G; also for No. 51291 - - - - - | 21 |
| 22716 | Screw, for looper drive eccentric oil disc on looper drive eccentric assemblies Nos. 29105 L, 29105 M- - - - - | 22 |
| 22716 A | Screw, for looper drive eccentric oil disc washer on looper drive eccentric assemblies Nos. 29105 L, 29105 M - - - - - | 22 |
| 22726 | Screw, for cloth plate cover spring on Styles 51200 M, 51200 R, 51200 S, 51200 T, 51400 P, 51400 Q, 51400 R, 51400 S, 51400 T, 51400 U, 51400 V, 51400 W, 51400 X, 51400 Y, 51400 AA, 51400 AB, 51700 J, 51700 K, 51700 N, 51700 P, 51700 Q, 51700 R, Nos. 32 and 40 gauge Style 51700 L- - - - - | 22 |

LIST OF PARTS

| Symbol to Order By | The figures in the last column refer only to the plates illustrating the parts and are not to be used in ordering. Prices furnished on application. | Plate No. |
|--------------------|---|-----------|
| 22726 A | Screw, for cloth plate cover spring on Styles 51200 A, 51200 B, 51200 C, 51200 D, 51200 G, 51200 H, 51200 J, 51200 K, 51200 L, 51200 N, 51400 B, 51400 C, 51400 D, 51400 F, 51400 G, 51400 H, 51400 J, 51400 M, 51400 N, 51600 A, 51700 C, 51700 D, 51700 E, 51700 F, 51700 G, 51700 H, 51700 M, 51700 T, 51700 U; also for Nos. 51777, K53851, K54262- - - - - | 20 |
| 22730 | Screw, for frame needle thread guide; also for Nos. 23406 A, 23406 B - - - - - | 21 |
| 22733 A | Plug Screw, for needle thread take-up hole on Styles 51200 U, 51200 V - - - - - | 21 |
| 22735 | Pivot Stud, for binder bracket on Styles 51200 B, 51200 L; also for No. 23449 A- - - - | 22 |
| 22743 | Screw, for upper differential feed roll on Styles 51700 E, 51700 L; also for No. 39237 - | 20 |
| 22747 | Screw, for clutch disc on Styles 51200 U, 51200 V, 51400 G- - - - - | 21 |
| 22752 B | Screw, for adjusting presser foot bottoms on Styles 51400 B, 51400 C, 51400 D, 51400 F, 51400 N, 51400 Q, 51400 R, 51400 S, 51400 U, 51400 AB, 51700 C, 51700 D, 51700 J, 51700 K, 51700 Q, 51700 R- - - - - | 24 |
| 22758 B | Screw, for lifter lever link on Styles 51200 K, 51200 L, 51200 M, 51200 N, 51200 R, 51200 S, 51200 T, 51400 P, 51400 Q, 51400 R, 51400 S, 51400 T, 51400 U, 51400 V, 51400 W, 51400 X, 51400 Y, 51400 AA, 51400 AB, 51700 J, 51700 K, 51700 L, 51700 M, 51700 N, 51700 P, 51700 Q, 51700 R, 51700 U; also for Nos. 52835 D, 52835 G- - - - - | 22 |
| 22764 A | Spot Screw, for parallel take-up on Style 51400 G - - - - - | 20 |
| 22765 | Clamp Screw, for presser foot on Style 51400 AC | 21 |
| 22768 | Screw, for needle bar and needle lever thread eyelets, also for Nos. 2603 K, 51236 B, 52958- | 20 |
| 22769 | Screw, for crank chamber oil tube clamp on Styles 51200 A, 51200 B, 51200 C, 51200 D, 51200 G, 51200 H, 51200 J, 51200 U, 51200 V, 51400 A, 51400 B, 51400 C, 51400 D, 51400 E, 51400 F, 51400 G, 51400 H, 51400 J, 51400 K, 51400 M, 51400 N, 51400 AC, 51600 A, 51700 C, 51700 D, 51700 E, 51700 F, 51700 G, 51700 H, 51700 T- - - - - | 22 |
| 22772 | Screw, for edge guide throw-out lever on Styles 51200 D, 51200 N- - - - - | 22 |
| 22773 | Screw, for folder swinging arm on Styles 51400 B, 51400 C, 51400 Q, 51400 R, 51700 C, 51700 D, 51700 G, 51700 H, 51700 J, 51700 K, 51700 N, 51700 P, 51700 Q- - - - - | 23 |

LIST OF PARTS

| Symbol to Order By | The figures in the last column refer only to the plates illustrating the parts and are not to be used in ordering. Prices furnished on application. | Plate No. |
|--------------------|--|-----------|
| 22778 | Screw, for lifter lever spring on Styles 51200 K, 51200 L, 51200 M, 51200 N, 51200 R, 51200 S, 51200 T, 51400 P, 51400 Q, 51400 R 51400 S, 51400 T, 51400 U, 51400 V, 51400 W, 51400 X, 51400 Y, 51400 AA, 51400 AB, 51700 J, 51700 K, 51700 L, 51700 M, 51700 N, 51700 P, 51700 Q, 51700 R, 51700 U- - - - - | 23 |
| 22788 | Screw, for puller frame on Style 51400 G- - - | 22 |
| 22794 B | " for parallel take-up flange on Style 51400 G- - - - - | 23 |
| 22795 | Stitch Regulating Screw - - - - - | 24 |
| 22797 | Stop Screw, for differential feed roll yolk support for Styles 51700 E, 51700 L - - - - | 22 |
| 22799 | Hinge Screw, length overall 21/32 inch, diam- eter .177 inch, for presser foot bottom on Styles 51700 F, 51700 M, 51700 T, 51700 U - | 23 |
| 22799 B | Hinge Screw, length overall 19/32 inch, diam- eter .088 inch, for presser foot bottoms on Styles 51200 J, 51200 T, 51400 A, 51400 E, 51400 K, 51400 P, 51400 T, 51400 X- - - - - | 23 |
| 22799 D | Hinge Screw, length overall 49/64 inch, diam- eter .124 inch, for presser foot bottom on Styles 51400 B, 51400 C, 51400 D, 51400 F, 51400 N, 51400 Q, 51400 R, 51400 S, 51400 U, 51700 C, 51700 D, 51700 J, 51700 K, 51700 Q, 51700 R - - - - - | 23 |
| 22799 E | Hinge Screw, length overall, 41/64 inch, diam- eter .088 inch, for presser foot bottom on Style 51400 AC- - - - - | 23 |
| 22799 G | Hinge Screw, length overall, 25/64 inch, diam- eter .088 inch, for presser foot bottoms on Styles 51200 P- - - - - | 23 |
| 22799 N | Screw, for cloth plate slide, rear, on Styles 51200 A, 51200 B, 51200 C, 51200 D, 51200 G, 51200 H, 51200 J, 51200 U, 51200 V, 51400 A, 51400 B, 51400 C, 51400 D, 51400 E, 51400 F, 51400 H, 51400 J, 51400 K, 51400 M, 51400 N, 51400 AC, 51600 A, 51700 C, 51700 D, 51700 E, 51700 F, 51700 G, 51700 H, 51700 T | 23 |
| 22799 P | Hinge Screw, headless, 29/64 inch long, diam- eter .088 inch, for presser foot bottom on Style 51200 U - - - - - | 23 |
| 22801 | Stop Screw, for stitch regulating stud, also needle guard pivot screw- - - - - | 23 |
| 22810 | Clamp Screw, for thread stand lead eyelet ball socket on Styles "G" and "H" thread stands- | 23 |
| 22813 | Screw, headless, for lifter treadle pin - - - | 20 |
| 22819 | Needle Bar Set Screw, for Styles 51200 U, 51200 V - - - - - | 20 |
| 22829 | Locking Screw, for looper rocker cone nut; also for Nos. 51293 M, 51293 N- - - - - | 21 |

LIST OF PARTS

| Symbol to Order By | The figures in the last column refer only to the plates illustrating the parts and are not to be used in ordering. Prices furnished on application. | Plate No. |
|--------------------|---|-----------|
| 22830 | Set Screw, for presser feet on Styles 51200 U, 51200 V- - - - - | 21 |
| 22833 | Screw, for parallel take-up cast-off on Style 51400 G- - - - - | 24 |
| 22834 | Stud, for regulating needle rear guard; also for Nos. K57283, K59080- - - - - | 24 |
| 22835 | Stud, for looper rocker link on Class 51700- - - - - | 24 |
| 22837 | Thumbscrew, for face plate- - - - - | 24 |
| 22839 | Screw, fillister head, for throat plate support; also for No. 51401 C - - - - - | 21 |
| 22840 | Adapter Screw, for frame thread eyelet - - - - - | 24 |
| 22840 A | Screw, for regulating presser foot bottom on Styles 51200 B, 51200 C, 51200 L, 51200 M, 51400 E, 51400 T - - - - - | 20 |
| 22841 B | Cloth Plate Supporting Stud, for Styles 51200 U, 51200 V- - - - - | 46 |
| 22841 C | Cloth Plate Support Stud, for Styles 51400 G, 51400 AC, 51600 A, 51700 T - - - - - | 46 |
| 22845 B | Pivot Screw, for cloth plate cover spring on Styles 51200 M, 51200 N, 51200 R, 51200 S, 51200 T, 51400 P, 51400 Q, 51400 R, 51400 S, 51400 T, 51400 U, 51400 V, 51400 W, 51400 X, 51400 Y, 51400 AA, 51400 AB, 51700 J, 51700 K, Nos. 32 and 40 gauge Style 51700 L, Styles 51700 N, 51700 P, 51700 Q, 51700 R - - - - - | 23 |
| 22848 | Screw, for oil reservoir back cover on Styles 51200 K, 51200 L, 51200 M, 51200 N, 51200 R, 51200 S, 51200 T, 51400 P, 51400 Q, 51400 R, 51400 S, 51400 T, 51400 U, 51400 V, 51400 W, 51400 X, 51400 Y, 51400 AA, 51400 AB, 51700 J, 51700 K, 51700 L, 51700 M, 51700 N, 51700 P, 51700 Q, 51700 R, 51700 U; also for Nos. 51235 N, 51239 K, 51758, 52835 N, 52885 G, 52885 H- - - - - | 21 |
| 22849 | Screw, right, for upper crank chamber cover, also for No. 51282 J - - - - - | 21 |
| 22863 | Adjusting Screw, for feed dog holder - - - - - | 24 |
| 22863 A | Folder Base Regulating Screw, for Styles 51400 B, 51400 C, 51400 Q, 51400 R, 51700 C, 51700 D, 51700 J, 51700 K, 51700 Q- - - - - | 24 |
| 22864 | Needle Lever Link Pin Clamp Screw, for styles in Class 51400, 51700, Styles 51200 K, 51200 L, 51200 M, 51200 N, 51200 R, 51200 S, 51200 T, 51600 A- - - - - | 22 |
| 22868 A | Differential Feed Regulating Stud, for Styles 51200 V, 51400 AC, 51600 A (washer No. 39236 A, nut No. 907)- - - - - | 22 |
| 22872 | Screw for crankshaft chamber cover, upper rear, on Styles 51200 U, 51200 V, 51400 G, 51400 AC, 51600 A, 51700 T - - - - - | 23 |

LIST OF PARTS

| Symbol to Order By | The figures in the last column refer only to the plates illustrating the parts and are not to be used in ordering. Prices furnished on application. | Plate No. |
|--------------------|--|-----------|
| 22874 | Screw, front, for oil reservoir baffle plate on Styles 51700 M, 51700 N, 51700 U; also for Nos. K55310, K58494, K58495, K59002- | 21 |
| 22882 A | Clamp Screw, for looper drive lever No. 51242 N | 22 |
| 23100 | Double Edge Folder and Guide, 3/64 inch capacity, for Styles 51200 G, 51200 R, (screw No. 25 C) | 35 |
| 23144 A | Spring Washer, for folder swinging arm on Styles 51200 U, 51200 V | 26 |
| 23168 Q | Hemmer, for 7/8 inch hem on No. 48 gauge Styles 51400 N, 51400 AB (screw No. 25 C) | 54 |
| 23168 R | Hemmer, for 5/8 inch hem on No. 32 gauge Styles 51400 F, 51400 U (screw No. 25 C) | 54 |
| 23215 BC-5/8 | Binder, for selvage edge and prefolded binding 5/8 inch wide, 5/32 inch capacity, for body fabric on Styles 51200 B, 51200 L (screw No. 90) | 36 |
| 23215 BC-3/4 | Binder, for selvage edge and prefolded binding 3/4 inch wide (screw No. 90) | 36 |
| 23215 BC-7/8 | Binder, for selvage edge and prefolded binding 7/8 inch wide (screw No. 90) | 36 |
| 23229 M | Folder Swinging Arm Support, for Styles 51400 B, 51400 C, 51400 Q, 51400 R, 51700 C, 51700 D, 51700 G, 51700 H, 51700 J, 51700 K, 51700 N, 51700 P, 51700 Q (screw No. 93) | 37 |
| 23229 N | Folder Swinging Arm (pivot screw No. 22773, thumbscrew No. 25 T) | 36 |
| 23229 P | Folder Bracket, for Styles 51400 B, 51400 C, 51400 Q, 51400 R, 51700 C, 51700 D, 51700 H, 51700 J, 51700 K, 51700 Q (screw No. 22528) | 37 |
| 23229 Q | Folder Clamp, for Styles 51400 B, 51400 C, 51400 Q, 51400 R, 51700 C, 51700 D, 51700 H, 51700 J, 51700 K, 51700 Q (screw No. 25 S, regulating screw No. 22863 A) | 37 |
| 23253 B | Folder, upper, for gathering and stitching flounce to body of petticoats on Nos. 10, 12, and 16 gauge Style 51600 A (screw No. 22561) | 33 |
| 23253 F | Folder, lower, for turning edge of flounce on Nos. 10, 12, and 16 gauge Style 51600 A (screw No. 25 C) | 33 |
| 23279 D | Folder Threader | 50 |
| 23293 N | Lower Folder Support, for Styles 51700 T, 51700 U (screw No. 22548) | 53 |

LIST OF PARTS

| Symbol to Order By | The figures in the last column refer only to the plates illustrating the parts and are not to be used in ordering. Prices furnished on application. | Plate No. |
|--------------------|---|-----------|
| 23293 P-96 | Folder, lower, for No. 96 gauge Styles 51700 T, 51700 U, uses strip 2 1/2 inches wide, finished width 1 3/4 inches (screw No. 25 C) - - - - - | 55 |
| 23300 G | Piping Guide, uses bias cut strip 5/8 inch wide and 3/32 inch diameter cord for Styles 51700 G, 51700 H, 51700 N, 51700 P (screw No. 187 A) - - - - - | 35 |
| 23322 AB-3/4 | Binder, for cut edge binding 3/4 inch wide, finishes 7/32 inch, 1/8 inch capacity for body fabric on Styles 51200 A, 51200 K - - - - - | 36 |
| 23322 AB-7/8 | Binder, for cut edge binding 7/8 inch wide, finishes 1/4 inch, 1/8 inch capacity for body fabric - - - - - | 36 |
| 23322 AB-1 | Binder, for cut edge binding, 1 inch wide, finishes 9/32 inch, 1/8 inch capacity for body fabric - - - - - | 36 |
| 23322 AB-1 1/8 | Binder, for cut edge binding 1 1/8 inches wide, finishes 11/32 inch, 5/32 inch capacity for body fabric - - - - - | 36 |
| 23322 AB-1 1/4 | Binder, for cut edge binding, 1 1/4 inches wide, finishes 13/32 inch, 5/32 inch capacity for body fabric - - - - - | 36 |
| 23322 AC | Binder Screw No. 90 Binder Support, for Styles 51200 A, 51200 K (screw No. 90) - - - - - | 36 |
| 23324 G | Collapsible Folder Connection Link, for Styles 51700 F, 51700 M (stud No. 134) - - - - - | 36 |
| 23324 H | Collapsible Folder Operating Lever (stud No. 22557) - - - - - | 37 |
| 23324 J | Collapsible Folder Operating Lever Stop (screw No. 25 CC) - - - - - | 35 |
| 23324 R | Collapsible Folder Connection, upper (adjusting screw No. 98 A, pivot stud No. 402) - - - - - | 53 |
| 23324 U | Scroll Connection Guide, for Styles 51700 F, 51700 M (screw No. 93 A) - - - - - | 37 |
| 23324 V | Scroll Connection Guide Support (screw No. 93 A) - - - - - | 37 |
| 23325 T-120 | Folder, upper, for turning edge of garment on Nos. 96 gauge Styles 51700 T, 51700 U (screw No. 25 C) - - - - - | 55 |
| 23360 C-1 1/2 | Collapsible Folder, for 1 1/2 inch overall bands, uses strip cut 3 3/4 inches wide on No. 88 gauge Styles 51700 F, 51700 M (screw No. 25 C) - - - - - | 54 |
| 23360 F-1/2 | Folder, for 1/2 inch button stay on Styles 51200 J, 51200 T, uses strip - cut 1 1/2 inches wide (screw No. 25 C) | 54 |

LIST OF PARTS

| Symbol to Order By | The figures in the last column refer only to the plates illustrating the parts and are not to be used in ordering. Prices furnished on application. | Plate No. |
|--------------------------|--|--------------|
| 23386 E-7/16 | Reverse Hemmer, with shiftable elastic, for hemming bloomers with 7/16 inch hem on Style 51400 G- - - - - | 55 |
| 23386 E-15/32 | Reverse Hemmer, for 15/32 inch hem- - - - - | 55 |
| 23386 E-1/2 | " " for 1/2 inch hem- - - - - | 55 |
| 23386 E-9/16 | " " for 9/16 inch hem- - - - - | 55 |
| 23386 E-19/32 | " " for 19/32 inch hem- - - - - | 55 |
| 23386 E-5/8 | " " for 5/8 inch hem- - - - - | 55 |
| | Reverse Hemmer Screw No. 25 C. | |
| 23401 J-56 | Center Plait Folder, "Tru-Front" type, 1/32 inch capacity, for No. 56 gauge Styles 51700 C, 51700 D, 51700 J, 51700 K, plait extends 5/16 inch beyond the rows of stitches, finish width 1 1/2 inches, uses plait cut 2 5/8 inches and interlining strip cut 1 15/32 inches- - - - - | 55 |
| 23401 K-48 | Center Plait Folder, "Tru-Front" type, 1/32 inch capacity, for No. 48 gauge Styles 51400 B, 51400 C, 51400 Q, 51400 R; plait extends 1/4 inch beyond the rows of stitches, finish width 1 1/4 inches, uses plait cut 2 1/4 inches and interlining strip cut 1 7/32 inches- - - - - | 55 |
| 23401 K-56 | Center Plait Folder, "Tru-Front" type, 1/32 inch capacity, for No. 56 gauge Styles 51700 C, 51700 J, plait extends 1/4 inch beyond the rows of stitches, finish width 1 3/8 inches, uses plait cut 2 3/8 inches and interlining strip cut 1 11/32 inches- - - - - | 55 |
| 23401 K-64 | Center Plait Folder, "Tru-Front" type, 1/32 inch capacity, for No. 64 gauge Styles 51700 C, 51700 D, 51700 J, 51700 K, plait extends 1/2 inch beyond the rows of stitches, finish width 1 1/2 inches, uses plait cut 2 1/2 inches and interlining strip cut 1 15/32 inches - - - - - | 55 |
| 23402 D | Attaching Screw No. 93 A. Folder Support, for use with No. 23406 A-5/8 on Style 51200 U; also for Styles 51400 M, 51400 AA (screw No. 25 C)- - - - - | 37 |
| 23403-48 | Angular Strip Guide, reversible, for No. 48 gauge, Styles 51400 B, 51400 C, 51400 Q, 51400 R - - - - - | 35 |
| 23403-56 | Angular Strip Guide, reversible, for No. 56 gauge Styles 51700 C, 51700 J - - - - - | 35 |

LIST OF PARTS

| Symbol to Order By | The figures in the last column refer only to the plates illustrating the parts and are not to be used in ordering. Prices furnished on application. | Plate No. |
|--------------------|---|-----------|
| 23403-64 | Angular Strip Guide, reversible, for No. 64 gauge, Styles 51700 C, 51700 D, 51700 J, 51700 K- - - - - | 35 |
| 23404 B | Angular Strip Guide Screw No. 25 B. Edge Guide, for body of garment on Styles 51700 F, 51700 M (screw No. 25 C) - - - - - | 34 |
| 23404 E | Edge Guide, for body of garment on Styles 51400 B, 51400 Q, 51700 D, 51700 K (screw No. 25 C) - - - - - | 34 |
| 23405 F | Folder, for turning body of garment upwardly, 1/32 inch capacity, 5/16 inch fold, on Style 51400 Y (screw No. 25 C) - - - - - | 35 |
| 23405 J | Folder, for turning body of garment downwardly, 1/32 inch capacity, 5/16 inch fold on Styles 51400 D, 51400 S (screw No. 25 C) - - - - - | 33 |
| 23405 L | Folder, for turning body of garment upwardly, 1/32 inch capacity, 5/16 inch fold on Styles 51400 C, 51400 R, 51700 C, 51700 J (screw No. 25 C) - - | 34 |
| 23405 N | Folder, for turning edge of sleeve upwardly, 1/16 inch capacity, 1/4 inch fold on Styles 51700 G, 51700 H, 51700 N, 51700 P (screw No. 25 C) - - | 35 |
| 23406 A-5/8 | Folder, 1/32 inch capacity, for attaching 5/8 inch button stays to garments made from woven fabrics, uses strip cut 1 3/4 inches wide; used with support No. 23402 D for Style 51200 U (folder screw No. 22730) - - - - - | 55 |
| 23406 B-7/8 | Folder, for 7/8 inch button stays, uses 2 1/4 inch strip on Styles 51400 M, 51400 AA (screw No. 22730) - - - - - | 54 |
| 23420 U-6-1/32 | Lap Seam Feller Assembly, 1/32 inch capacity, for No. 6 gauge Styles 51400 A, 51400 P; one each Nos. 23422 U-1/32, 28, 23421 U-6-1/32, 23425 V. Specify component parts in ordering- - - - - | 33 |
| 23420 U-8-1/32 | Lap Seam Feller Assembly, 1/32 inch capacity, for No. 8 gauge Styles 51400 A, 51400 P; one each Nos. 23442 U-1/32, 28, 23421 U-8-1/32, 23425 V. Specify component parts in ordering- - - - - | 33 |

LIST OF PARTS

| Symbol to Order By | The figures in the last column refer only to the plates illustrating the parts and are not to be used in ordering. Prices furnished on application. | Plate No. |
|--------------------------|--|--------------|
| 23420 U-8-1/16 | Lap Seam Feller Assembly, 1/16 inch capacity, for No. 8 gauge Styles 51400 A, 51400 P; one each Nos. 23422 U-1/16, 28, 2341 U-8-1/16, 23425 V. Specify component parts in ordering - - - - - | 33 |
| 23420 U-10-1/32 | Lap Seam Feller Assembly, 1/32 inch capacity, for No. 10 gauge Styles 51400 A, 51400 P; one each Nos. 23422 U-1/32, 28, 23421 U-10-1/32, 23425 V. Specify component parts in ordering - - - - - | 33 |
| 23420 U-10-1/16 | Lap Seam Feller Assembly, 1/16 inch capacity; one each Nos. 23422 U-1/16, 28, 23421 U-10-1/16, 23425 V. Specify component parts in ordering | 33 |
| 23420 U-12-1/32 | Lap Seam Feller Assembly, 1/32 inch capacity, for No. 12 gauge Styles 51400 A, 51400 P; one each Nos. 23442 U-1/32, 28, 23421 U-12-1/32, 23425 V. Specify component parts in ordering - - - - - | 33 |
| 23420 U-12-1/16 | Lap Seam Feller Assembly, 1/16 inch capacity; one each Nos. 23442 U-1/16, 28, 23421 U-12-1/16, 23425 V. Specify component parts in ordering - - - - - | 33 |
| 23420 U-12-3/32 | Lap Seam Feller Assembly, 3/32 inch capacity, one each Nos. 23422 U-3/32, 28, 23421 U-12-3/32, 23425 V. Specify component parts in ordering - - - - - | 33 |
| 23420 U-16-1/16 | Lap Seam Feller Assembly, 1/16 inch capacity, for No. 16 gauge Styles 51400 A, 51400 P; one each Nos. 23422 U-1/16, 28, 23421 U-16-1/16, 23425 V. Specify component parts in ordering - - - - - | 33 |
| 23420 U-16-3/32 | Lap Seam Feller Assembly, 3/32 inch capacity; one each Nos. 23422 U-3/32, 28, 23421 U-16-3/32, 23425 V. Specify component parts in ordering - - - - - | 33 |
| 23420 U-16-1/8 | Lap Seam Feller Assembly, 1/8 inch capacity; one each Nos. 23422 U-1/8, 28, 23421 U-16-1/8, 23425 V. Specify component parts in ordering - - - - - | 33 |
| 23420 U-18-1/16 | Lap Seam Feller Assembly, 1/16 inch capacity, for No. 18 gauge Styles 51400 A, 51400 P; one each Nos. 23442 U-1/16, 28, 23421 U-18-1/16, 23425 V. Specify component parts in ordering - - - - - | 33 |

LIST OF PARTS

| Symbol to Order By | The figures in the last column refer only to the plates illustrating the parts and are not to be used in ordering. Prices furnished on application. | Plate No. |
|--------------------------|---|--------------|
| 23420 U-18-3/32 | Lap Seam Feller Assembly, 3/32 inch capacity; one each Nos. 23422 U-3/32, 28, 23421 U-18-3/32, 23425 V. Specify component parts in ordering- - - - - | 33 |
| 23420 U-18-1/8 | Lap Seam Feller Assembly, 1/8 inch capacity; one each Nos. 23422 U-1/8, 28, 23421 U-18-1/8, 23425 V. Specify component parts in ordering- - - - - | 33 |
| 23420 U-26-1/16 | Lap Seam Feller Assembly, 1/16 inch capacity, for No. 26 gauge Styles 51400 J, 51400 W; one each Nos. 23422 U-1/16, 28, 23421 U-26-1/16, 23425 V. Specify component parts in ordering - - - - - | 33 |
| 23420 V-8-1/32 | Lap Seam Feller Assembly, 1/32 inch capacity, for No. 8 gauge Styles 51400 E, 51400 T; one each Nos. 23422 V-1/32, 28, 23421 V-8-1/32, 23425 V. Specify component parts in ordering - - - - - | 33 |
| 23420 V-10-1/32 | Lap Seam Feller Assembly, 1/32 inch capacity, for No. 10 gauge; one each Nos. 23422 V-1/32, 28, 23421 V-10-1/32, 23425 V. Specify component parts in ordering - - - - - | 33 |
| 23420 V-12-1/32 | Lap Seam Feller Assembly, 1/32 inch capacity, for No. 12 gauge; one each Nos. 23422 V-1/32, 28, 23421 V-12-1/32, 23425 V. Specify component parts in ordering - - - - - | 33 |
| 23420 V-16-1/32 | Lap Seam Feller Assembly, 1/32 inch capacity, for No. 16 gauge; one each Nos. 23422 V-1/32, 28, 23421 V-16-1/32, 23425 V. Speciy component parts in ordering - - - - - | 33 |
| 23421 U-6-1/32 | Upper Scroll, for lap seam feller, 1/32 inch capacity, for No. 6 gauge Styles 51400 A, 51400 P - - - - - | 33 |
| 23421 U-8-1/32 | Upper Scroll, 1/32 inch capacity, for No. 8 gauge- - - - - | 33 |
| 23421 U-8-1/16 | Upper Scroll, 1/16 inch capacity - - - - - | 33 |
| 23421 U-10-1/32 | " " 1/32 inch capacity, for No. 10 gauge - - - - - | 33 |
| 23421 U-10-1/16 | " " 1/16 inch capacity - - - - - | 33 |
| 23421 U-12-1/32 | " " 1/32 inch capacity, for No. 12 gauge - - - - - | 33 |
| 23421 U-12-1/16 | " " 1/16 inch capacity - - - - - | 33 |
| 23421 U-12-3/32 | " " 3/32 inch capacity - - - - - | 33 |
| 23421 U-16-1/16 | " " 1/16 inch capacity, for No. 16 gauge - - - - - | 33 |
| 23421 U-16-3/32 | " " 3/32 inch capacity - - - - - | 33 |

LIST OF PARTS

| Symbol to Order By | The figures in the last column refer only to the plates illustrating the parts and are not to be used in ordering. Prices furnished on application. | Plate No. |
|--------------------------|--|--------------|
| 23421 U-16-1/8 | Upper Scroll 1/8 inch capacity- - - - - | 33 |
| 23421 U-18-1/16 | " " 1/16 inch capacity, for No. 18 gauge - - - - - | 33 |
| 23421 U-18-3/32 | " " 3/32 inch capacity - - - - - | 33 |
| 23421 U-18-1/8 | " " 1/8 inch capacity- - - - - | 33 |
| 23421 U-26-1/16 | Upper Scroll, 1/16 inch capacity, for No. 26 gauge Styles 51400 J, 51400 W- | 33 |
| 23421 V-8-1/32 | Upper Scroll, 1/32 inch capacity, for No. 8 gauge Style 51400 E, 51400 T- - | 33 |
| 23421 V-10-1/32 | Upper Scroll, 1/32 inch capacity, for No. 10 gauge- - - - - | 33 |
| 23421 V-12-1/32 | Upper Scroll, 1/32 inch capacity, for No. 12 gauge- - - - - | 33 |
| 23421 V-16-1/32 | " " 1/32 inch capacity, for No. 16 gauge- - - - - | 33 |
| 23422 U-1/32 | Upper Scroll Screw No. 28 Lower Scroll and Base, for lap seam feller, 1/32 inch capacity, for Nos. 6, 8, and 10 gauge Styles 51400 A, 51400 P - - - - - | 34 |
| 23422 U-1/16 | Lower Scroll and Base, 1/16 inch capacity, for Nos. 12, 16 and 18 gauge Styles 51400 A, 51400 P; also for No. 26 gauge Styles 51400 J, 51400 W - - - - - | 34 |
| 23422 V-1/32 | Lower Scroll and Base, 1/32 inch capacity, for Styles 51400 E, 51400 T - - - - - | 34 |
| 23425 T | Lower Scroll and Base Screw No. 25 C. Washer Plate, for binder on Styles 51200 A, 51200 B, 51200 K, 51200 L- - | 31 |
| 23425 U | Washer Plate, .025 inch thick, for cloth plate attachments- - - - - | 34 |
| 23425 V | Washer Plate, .050 inch thick - - - - - | 34 |
| 23432 | Folder Clamp, for upper folder on Style 51200 V (screw No. 25 CC) - - - - | 37 |
| 23432 A | Folder Clamp, for upper folder on Styles 51700 G, 51700 H, 51700 N, 51700 P (screw No. 25 CC) - - - - - | 37 |
| 23435-32 | Facing Strip Folder, 1/32 inch capacity, uses 1 inch strip, finishes 5/8 inch, for No. 32 gauge Styles 51400 D, 51400 S - - - - - | 54 |
| 23435-48 | Facing Strip Folder, 1/32 inch capacity, uses 1 1/4 inch strip, finishes 7/8 inch for No. 48 gauge Styles 51400 B, 51400 D, 51400 Q, 51400 S- - | 54 |
| 23435-64 | Facing Strip Folder, 1/32 inch capacity, uses 1 1/2 inch strip, finishes 1 1/8 inches, for No. 64 gauge Styles 51700 D, 51700 K- - - - - | 54 |
| | Facing Strip Folder Washer No. 9255 Facing Strip Folder Screw No. 22548 | |

LIST OF PARTS

| Symbol to Order By | The figures in the last column refer only to the plates illustrating the parts and are not to be used in ordering. Prices furnished on application. | Plate No. |
|--------------------|---|-----------|
| 23436 | Facing Strip Folder Bracket, for Styles 51400 B, 51400 D, 51400 Q, 51400 S, 51700 D, 51700 K, 51700 R, (washer No. 9255, screw No. 136) - - - - - | 37 |
| 23437 A | Binder Bracket, for Styles 51200 B, 51200 L (washer No. 12957 E, screw No. 22735) - - - | 36 |
| 23437 B | Binder Bracket Support (screw No. 22585) - - - | 36 |
| 23438 A | Supplemental Guide Plate, for Styles 51200 A, 51200 K (screw No. 25 C) - - - - - | 35 |
| 23438 B | Supplemental Guide Platform, for Styles 51200 B, 51200 L (screw No. 90) - - - - - | 35 |
| 23439 A | Pin Tension for Styles 51200 A, 51200 B, 51200 K, 51200 L (screw No. 90) - - - - - | 35 |
| 23439 B | Pin Tension Assembly, for Style 51200 V (attaching screw No. 22548) - - - - - | 53 |
| 23439 C | Pin Tension Adjustable Pin, for Style 51200 V, (thumb screw No. 188 D) - - - - - | 53 |
| 23447-64 | Strip Folder, for No. 64 gauge Styles 51700 E, 51700 L - - - - - | 36 |
| 23447-72 | Strip Folder, for No. 72 gauge - - - - - | 36 |
| 23447-80 | Strip Folder, for No. 80 gauge - - - - - | 36 |
| 23447 A | Strip Folder Guide (screw No. 22593) - - - - - | 35 |
| 23447 B | Strip Folder Bracket (screw No. 22548) - - - - - | 37 |
| 23447 C | Strip Folder Sliding Base Spring (screw No. 22593) - - - - - | 31 |
| 23448-64 | Guide, for leading strip to feed dog on No. 64 gauge Styles 51700 E, 51700 L - - - - - | 38 |
| 23448-72 | Guide, for No. 72 gauge - - - - - | 38 |
| 23448-80 | Guide, for No. 80 gauge - - - - - | 38 |
| | Guide screw No. 22504 | |
| | Guide Spring No. 51785 | |
| | Guide Washer No. 8372 A | |
| 23449 | Body Folder, complete, 1/16 inch capacity, for Nos. 64, 72, and 80 gauge Styles 51700 E, 51700 L; (sliding base No. 23449 A, sliding base guide No. 23449 B, spring No. 23449 C, spring attaching screw No. 187 A, pivot stud No. 22735, pivot stud washer No. 12957 E, stripper blade adjusting stud No. 22532, stripper blade set screw No. 88, body folder attaching screw No. 25 C) - - - - - | 34 |
| 23449 A | Body Folder Sliding Base, for Styles 51700 E, 51700 L (pivot screw No. 22735, pivot screw washer No. 12957 E) - - - - - | 37 |
| 23449 B | Body Folder Sliding Base Guide (screw No. 605 A) - - - - - | 35 |
| 23449 C | Body Folder Spring (screw No. 187 A) - - - - - | 31 |
| 28577 | Washer, for rear knee press shaft bracket on assembly No. 21693 A - - - - - | 26 |
| 28604 G | Straight Mineral Oil, SAE-10 "W", put up in 10 fluid ounces to can, which is the capacity of machine - - - - - | - |

LIST OF PARTS

| Symbol to Order By | The figures in the last column refer only to the plates illustrating the parts and are not to be used in ordering. Prices furnished on application. | Plate No. |
|--------------------|--|-----------|
| 28606-1/2 | Powdered Oil Stone, 1/2 lb. package- - - - - | --- |
| 28606-1 | " " " 1 lb. package- - - - - | --- |
| 28619 | Puller Presser Roller Axle Spring Ball, also for plugging hole in main oil reservoir on Styles 51700 F, 51700 G, 51700 T- - | 19 |
| 29066 F | Needle Lever Connecting Rod Upper Bearing Assembly; one each Nos. 51216 A, 51243 B - | 40 |
| *29105 A | Looper Drive Eccentric Assembly, external oiling, includes eccentric No. 51443, for Styles 51200 A, 51200 G, 51200 H, 51400 G (set screw No. 98, spot screw No. 96, bearing screw, upper, No. 75 A, bearing screw, lower, No. 97 A)- - - - - | 40 |
| *29105 B | Looper Drive Eccentric Assembly, external oiling, includes eccentric No. 51343, for Styles 51200 B, 51200 C, 51200 J (set screw No. 98, spot screw No. 96, bearing screw, upper, No. 75 A, bearing screw, lower, No. 97 A) - - - - - | 40 |
| *29105 L | Looper Drive Eccentric Assembly, internal and external oiling, includes eccentric No. 51243 P, for Styles 51200 A, 51200 D, 51200 G, 51200 H, 51200 U, 51200 V, 51400 A, 51400 B, 51400 C, 51400 D, 51400 E, 51400 F, 51400 H, 51400 J, 51400 K, 51400 M, 51400 N, 51400 AC, 51600 A, 51700 C, 51700 D, 51700 E, 51700 F, 51700 G, 51700 H, 51700 T (set screw No. 98, spot screw No. 96, bearing screw, upper, No. 22559 B, bearing screw, lower, No. 22559 A)- - - - - | 40 |
| *29105 M | Looper Drive Eccentric Assembly, internal and external oiling, includes eccentric No. 51243 Q, for Styles 51200 B, 51200 C, 51200 J (set screw No. 98, spot screw No. 96, bearing screw, upper, No. 22559 B, bearing screw, lower, No. 22559 A) - - - - - | 40 |
| *29105 P | Looper Drive Eccentric Assembly, includes eccentric No. 51443, for Styles 51200 K, 51200 N, 51200 R, 51200 S, 51400 P, 51400 Q, 51400 R, 51400 S, 51400 T, 51400 U, 51400 V, 51400 W, 51400 X, 51400 Y, 51400 AA, 51400 AB, 51700 J, 51700 K, 51700 L, 51700 M, 51700 N, 51700 P, 51700 Q, 51700 R, 51700 U (set screw No. 98, spot screw No. 96, bearing screw, upper, No. 22559 B, bearing screw, lower, No. 22559 A) - - - - - | 40 |

*See Page 21

LIST OF PARTS

| Symbol to Order By | The figures in the last column refer only to the plates illustrating the parts and are not to be used in ordering. Prices furnished on application. | Plate No. |
|--------------------|---|-----------|
| #29105 Q | Looper Drive Eccentric Assembly, includes eccentric No. 51343, for Styles 51200 L, 51200 M, 51200 T, (set screw No. 98, spot screw No. 96, bearing Screw, upper No. 22559 B, bearing screw, lower, No.22559 A)- | 40 |
| #29114 A | Feed Clutch Driving Eccentric Assembly, includes eccentric No. 53551, for Style 51200 V (spot Screw No. 81, set screw No. 95, bearing screw No. 22559 C, plug screw No. 22586)- | 40 |
| #29114 B | Feed Clutch Driving Eccentric Assembly, for Style 51200 U, includes eccentric No. 53551 A, spot Screw No. 81, set screw No. 95, bearing screw No. 22559 C, plug screw No. 22586)- | 40 |
| #29138 H | Puller Driving Eccentric Assembly, .203 inch throw, stitch range 7 to 13 per inch, includes eccentric No. 21703 H, for Style 51700 F (spot screw No. 81, set screw No. 95, bearing screw No. 22587)- | 40 |
| #29138 J | Puller Driving Eccentric Assembly, .156 inch throw, stitch range 11 to 16 per inch, includes eccentric No. 21703 J, for Style 51700 T (spot screw No. 81, set screw No. 95, bearing screw No. 22587)- | 40 |
| #29138 K | Puller driving Eccentric Assembly, .116 inch throw, stitch range 15 to 26 per inch, includes eccentric No. 21703 K, for Style 51700 G (spot screw No. 81, set screw No. 95, bearing screw No. 22587)- | 40 |
| #29138 M | Puller Driving Eccentric Assembly, .160 inch throw, stitch range 7 to 12 per inch, includes eccentric No. 53551 A, for Style 51400 G (spot screw No. 81, set screw No. 95, bearing screw No. 22559 C, plug screw No. 22586)- | 40 |
| #29138 Q | Puller Driving Eccentric Assembly, .203 inch throw, stitch range 7 to 13 per inch, includes eccentric No. 21703 N, for Style 51700 M (spot screw No. 81, set screw No. 95, bearing screw No. 22559 C, plug screw No. 22586)- | 40 |
| #29138 R | Puller Driving Eccentric Assembly, .156 inch throw, stitch range 11 to 16 per inch, includes eccentric No. 21703 P, for Style 51700 U (spot screw No. 81, set screw No. 95, bearing screw No. 22559 C, plug screw No. 22586)- | 40 |

LIST OF PARTS

| Symbol to Order By | The figures in the last column refer only to the plates illustrating the parts and are not to be used in ordering. Prices furnished on application. | Plate No. |
|--------------------|---|-----------|
| *29138 S | Puller Driving Eccentric Assembly, .116 inch throw, stitch range 15 to 26 per inch, includes eccentric No. 21703 M, for Style 51700 N (spot screw No. 81, set screw No. 95, bearing screw No. 22559 C, plug screw No. 22586) - - - - - | 40 |
| 29192 | Looper Rocker Assembly, for styles in Class 51200; one each Nos. 51213, 15465 F, 51745 lapper together, Nos. 258A, 22829; two No. 88 - - - - - | 40 |
| 29192 A | Looper Rocker Assembly, for Styles 51400 A, 51400 B, 51400 C, 51400 D, 51400 E, 51400 F, 51400 K, 51400 M, 51400 N, 51400 P, 51400 Q, 51400 R, 51400 S, 51400 T, 51400 U, 51400 X, 51400 Y, 51400 AA, 51400 AB, 51400 AC, 51600 A; Nos. 32 and 40 gauge Style 51700 L; one each Nos. 51413, 15465 F, 51745 lapper together, Nos. 258 A, 22829; two No. 88 - - - - - | 40 |
| 29192 C | Looper Rocker Assembly, for Styles 51700 C, 51700 D, 51700 E, 51700 F, 51700 G, 51700 H, 51700 J, 51700 K, Nos. 64, 72, and 80 gauge Style 51700 L, Styles 51700 M, 51700 N, 51700 P, 51700 Q, 51700 R, 51700 T, 51700 U; one each Nos. 51713, 15465 F, 51745 lapped together, Nos. 258 A, 22829; two No. 88 - - - - - | 40 |
| 29192 D | Looper Rocker Assembly, for Styles 51400 G, 51400 H, 51400 J, 51400 V, 51400 W; one each Nos. 51513, 15465 F, 51745 lapped together, Nos. 258 A, 22829; two No. 88 - - - - - | 40 |
| 29348 | Needle Lever Assembly, for Styles 51200 A, 51200 B, 51200 C, 51200 D, 51200 G, 51200 H, 51200 J, 51200 U, 51200 V; one each Nos. 51215 A, 51250 lapped together; Nos. 54, 77, 78, 35759; two each Nos. 88 A, 1286, 22519 - - - - - | 58 |
| 29348 B | Needle Lever Assembly, for styles in classes 51400, 51700, Styles 51200 K, 51200 L, 51200 M, 51200 N, 51200 R, 51200 S, 51200 T, 51600 A; one each Nos. 51215 C, 51250 lapped together, Nos. 54, 78, 22864, 35759, 51250 C; two each Nos. 88 A, 1286, 22528 - - - - - | 58 |
| 29402 | Lifter Treadle Assembly; one each Nos. 22813, 424, 423, 422 - - - - - | 53 |

*See Page 21

LIST OF PARTS

| Symbol to Order By | The figures in the last column refer only to the plates illustrating the parts and are not to be used in ordering. Prices furnished on application. | Plate No. |
|--------------------------|---|--------------|
| *29476 AD | Crankshaft Assembly for Styles 51200 A, 51200 D, 51200 G, 51200 H, 51200 U, 51200 V, 51400 A, 51400 B, 51400 C, 51400 D, 51400 E, 51400 F, 51400 G, 51400 H, 51400 J, 51400 K, 51400 M, 51400 N, 51400 AC, 51600 A, 51700 C, 51700 D, 51700 E, 51700 G, 51700 H; includes crankshaft No. 51422 A (bearing screw No. 75 A) - - - - - | 57 |
| *29476 AE | Crankshaft Assembly, for Styles 51700 F, 51700 T; includes crankshaft No. 51322 A (bearing screw No. 75 A) - - - - - | 57 |
| *29476 AF | Crankshaft Assembly, for Styles 51200 B, 51200 C, 51200 J; includes crankshaft No. 51222 A (bearing screw No. 75 A) - - - - - | 57 |
| *29476 AJ | Crankshaft Assembly, for Styles 51200 K, 51200 N, 51200 R, 51200 S, 51400 P, 51400Q, 51400 R, 51400 S, 51400 T, 51400 U, 51400 V, 51400 W, 51400 X, 51400 Y, 51400 AA, 51400 AB, 51700 J, 51700K, 51700 L, 51700 N, 51700 P, 51700 Q, 51700 R; includes crank- shaft No. 51422 A (bearing screw No. 75 A) | 57 |
| *29476 AK | Crankshaft Assembly, for Styles 51700 M, 51700 U; includes crankshaft No. 51322 A (bearing screw No. 75 A) - - - - - | 57 |
| *29476 AY | Crankshaft Assembly, for Styles 51200 L, 51200 M, 51200 T includes crankshaft No. 51222 A (bearing screw No. 75 A) - - - - - | 57 |
| 29730 A | Parallel Take-up Assembly, for Style 51400 G; one each Nos. 51423, 89, 22764 A, 22833, 51404, 51461, 51461 A, 51461 B, 51461 C; three No. 22794 B - - - - - | - |
| 35167 B | Dowel Pin, for top roller feed clutch bracket, on Styles 51200 U, 51200 V- - - - | 29 |
| 35731 A | Presser Bar Connection Guide Plate (screw No. 22513) - - - - - | 31 |
| 35733 B | Presser Spring Regulating Screw Lock Nut - - | 25 |
| 35759 | Needle Bar Connection (needle bar set screw No. 88 A, link pin set screw No. 78) - - - | 28 |
| 35768 A | Screw, left, for upper crank chamber cover - | 24 |
| 35788 B | Crank Chamber Reservoir Cover, for Styles 51200 A, 51200 B, 51200 C, 51200 D, 51200G, 51200 H, 51200 J, 51200 U, 51200 V, 51400 A, 51400 B, 51400 C, 51400 D, 51400 E, 51400 F, 51400 G, 51400 H, 51400 J, 51400 K, 51400 M, 51400 N, 51400 AC, 51600 A, 51700 C, 51700 D, 51700 E, 51700 F, 51700 G, 51700 H, 51700 T (screw No. 605)- - - - - | 47 |
| 35833 C | Presser Spring plate - - - - - | 39 |

*See Page 21

LIST OF PARTS

| Symbol to Order By | The figures in the last column refer only to the plates illustrating the parts and are not to be used in ordering. Prices furnished on application. | Plate No. |
|--------------------|--|-----------|
| 39132 V | End Cover Spring Pin, for Styles 51200 U, 51200 V, 51400 G, 51400 AC, 51600 A, 51700 T, also for Nos. 52885 G, 52885 H- - - - - | 29 |
| 39135 | Feed Bar Shaft, 2 inches long for Styles 51200 A, 51200 B, 51200 C, 51200 D, 51200 G, 51200 H, 51200 J, 51200 U, 51200 V, 51400 A, 51400 B, 51400 C, 51400 D, 51400 E, 51400 F, 51400 G, 51400 H, 51400 J, 51400 K, 51400 M, 51400 N, 51400 AC, 51600 A, 51700 C, 51700 D, 51700 E, 51700 F, 51700 G, 51700 H, 51700 T (set screw No. 22560 B) - - - - - | 45 |
| 39141 G | Nut, for feed clutch connecting rod ball joint on Styles 51200 U, 51200 V, also for puller connecting rod ball joint on Style 51400 G - | 25 |
| 39175 | Feed Clutch Drive Lever Connecting Rod (nut, right thread, No. 18, left thread, No. 269) | 46 |
| 39193 | Crank Chamber Oil Reservoir Sight Gauge Assembly, for Styles 51200 A, 51200 B, 51200 C, 51200 D, 51200 G, 51200 H, 51200 J, 51200 U, 51200 V, 51400 A, 51400 B, 51400 C, 51400 D, 51400 E, 51400 F, 51400 G, 51400 H, 51400 J, 51400 K, 51400 M, 51400 N, 51400 AC, 51600 A, 51700 C, 51700 D, 51700 E, 51700 F, 51700 G, 51700 H, 51700 T; one each Nos. 39193 A, 39193 B, 660-92, 660-93, 666-49 - - | 19 |
| 39193 A | Crank Chamber Oil Reservoir Sight Gauge Glass | 19 |
| 39193 B | Tube Cover - - - - - | 19 |
| 39236 | Crank Chamber Oil Reservoir Sight Gauge Base - | 19 |
| 39236 A | Differential Feed Driving Link Sliding Block, for Styles 51200 V, 51400 AC, 51600 A- - - - | 30 |
| 39236 T | Needle Rear Guard Washer, also for No. 22868 A | 26 |
| 39237 | Differential Feed Driving Link, for Styles 51200 V, 51400 AC, 51600 A - - - - - | 42 |
| 39237 | Differential Feed Bar Guide, for Styles 51200 V, 51400 AC, 51600 A (screw No. 22743) | 30 |
| 39237 D | Differential Feed Bar Guide Plate, for Styles 51200 V, 51400 AC, 51600 A (screw No. 22593) | 30 |
| 39237 G | Differential Feed Bar Bushing, for Styles 51200 V, 51400 AC, 51600 A - - - - - | 26 |
| K40881 | Folder, for 3/4 inch button stay, on Styles 51200 J, 51200 T, 51200 U, capacity 1/32 inch, uses 2 1/8 inch strip (screw No. 25 C, washer plate No. 23425 V) - - - - - | 54 |
| 41047 | Looper Connecting Rod, 2 3/8 inches long, for No. 96 and narrower gauge styles in Class 51700 (nut, right thread, No. 18, nut, left thread, No. 269) - - - - - | 30 |

LIST OF PARTS

| Symbol to Order By | The figures in the last column refer only to the plates illustrating the parts and are not to be used in ordering. Prices furnished on application. | Plate No. |
|--------------------|---|-----------|
| 41071 G | Nut, for oil tube brace, on Styles 51200 A, 51200 B, 51200 C, 51200 D, 51200 G, 51200 H, 51200 J, 51200 U, 51200 V, 51400 A, 51400 B, 51400 C, 51400 D, 51400 E, 51400 F, 51400 H, 51400 J, 51400 K, 51400 M, 51400 N, 51400 AC, 51600 A - - - - - | 25 |
| 41258 | Feed Clutch Roller, for Styles 51200 U, 51200 V, also for puller clutch on Style 51400 G - - - - - | 26 |
| 41258 A | Clutch Roller Spring (screw No. 22704) - - - - - | 32 |
| 41258 B | Clutch Disc, left (screw No. 22747) - - - - - | 29 |
| 41258 D | Clutch Housing (spot screw No. 81, set screw No. 95) - - - - - | 42 |
| 41258 E | Clutch Disc, right (screw No. 22747) - - - - - | 29 |
| 41258 CG | Puller Clutch Lever, for Style 51400 G - - - - - | 43 |
| 41358 | Clutch Spring Washer, for Styles 51200 U, 51200 V, 51400 G (screw No. 87 U) - - - - - | 26 |
| 43134 D | Feed Bar Shaft, for Styles 51200 K, 51200 L, 51200 M, 51200 N, 51200 R, 51200 S, 51200 T, 51400 P, 51400 Q, 51400 R, 51400 S, 51400 T, 51400 U, 51400 V, 51400 W, 51400 X, 51400 Y, 51400 AA, 51400 AB, 51700 J, 51700 K, 51700 L, 51700 M, 51700 N, 51700 P, 51700 Q, 51700 R, 51700 U (screw No. 22560 B) - - - - - | 45 |
| 43266 | Tension Post Nut, for styles in Class 51700, Styles 51400 A, 51400 B, 51400 C, 51400 D, 51400 E, 51400 F, 51400 H, 51400 J, 51400 K, 51400 M, 51400 N, 51400 P, 51400 Q, 51400 R, 51400 S, 51400 T, 51400 U, 51400 V, 51400 W, 51400 X, 51400 Y, 51400 AA, 51400 AB, 51400 AC, 51600 A - - - - - | 25 |
| 43281 K | Folder Swinging Arm Spring, for Styles 51200 U, 51200 V (screw No. 90) - - - - - | 31 |
| 43281 L | Folder Swinging Arm Latch, for Styles 51200 U, 51200 V (screw No. 22562) - - - - - | 29 |
| 43294 A | Oil Drain Support (screw No. 22596) - - - - - | 53 |
| 43294 D | Oil Drain Pipe, 3 inches long - - - - - | 49 |
| 43443 Q | Nut, for differential feed intermediate gear stud, on Styles 51700 E, 51700 L - - - - - | 25 |
| K49640 | Folder, for 7/8 inch button stay, on Styles 51200 J, 51200 T, 51200 U, 1/32 inch capacity, uses 2 3/8 inch strip (screw No. 25 C, washer plate No. 23425 V) - - - - - | 54 |
| K49746 | Folder, for 1 inch button stays, on Styles 51200 J, 51200 T, 51200 U, capacity 1/32 inch, uses 2 5/8 inch strip (screw No. 25 C, washer plate No. 23425 V) - - - - - | 54 |
| K49995 | Needle Rear Guard, for Styles 51700 G, 51700 H, 51700 N, 51700 P (pivot screw No. 22801, attaching screw No. 22585 B, washer No. 39236 A) - - - - - | 17 |

LIST OF PARTS

| Symbol to Order By | The figures in the last column refer only to the plates illustrating the parts and are not to be used in ordering. Prices furnished on application. | Plate No. |
|--------------------|---|-----------|
| K50410 | Presser Foot, for No. 128 gauge Styles 51700 G, 51700 H, 51700 N, 51700 P (clamp screw No. 91, yielding section spring, left, No. 16194, yielding section spring, right, No. 8040, yielding section spring attaching screw No. 605, yielding section spring adjusting screw No. 605 A, strip guide No. 16194 B, strip guide screw No. 73 A) - - - - | 12 |
| 51134 | Feed Bar, including tiltable feed dog holder, for Styles in Class 51700, Styles 51200 A, 51200 B, 51200 C, 51200 D, 51200 G, 51200 H, 51200 J, 51200 K, 51200 L, 51200 M, 51200 N, 51200 R, 51200 S, 51200 T, 51400 A, 51400 B, 51400 C, 51400 D, 51400 E, 51400 F, 51400 H, 51400 J, 51400 K, 51400 M, 51400 N, 51400 P, 51400 Q, 51400 R, 51400 S, 51400 T, 51400 U, 51400 V, 51400 W, 51400 X, 51400 Y, 51400 AA, 51400 AB, (set screw No. 22560 B, feed dog supporting screw No. 538, feed dog holder adjusting screw No. 22863, link pin screw No. 77) - - - - | 42 |
| 51134 A | Feed Bar, including tiltable feed dog holder, for Styles 51200 U, 51400 G (set screw No. 166, feed dog supporting screw No. 538, feed dog holder adjusting screw No. 22863, link pin screw No. 77) - - - - | 42 |
| 51134 G | Feed Dog Holder, tiltable, nut No.258 A, washer No. 6042 A - - - - | 17 |
| 51135 | Feed Rocker, for Styles 51700 M, 51700 U (screw No. 98) - - - - | 42 |
| 51145 | Looper Avoid Eccentric Link. also feed lift eccentric link, for Styles 51200 K, 51200 L, 51200 M, 51200 N, 51200 R, 51200 S, 51200 T, 51400 P, 51400 Q, 51400 R, 51400 S, 51400 T, 51400 U, 51400 V, 51400 W, 51400 X, 51400 Y, 51400 AA, 51400 AB, 51700 J, 51700 K, 51700 L, 51700 M, 51700 N, 51700 P, 51700 Q, 51700 R, 51700 U - - - - | 28 |
| 51147 | Main Shaft Collar (screw No. 95) - - - - | 26 |
| K51165 | Folder Bracket, for use with folder swinging arm on Styles 51700 G, 51700 H, 51700 N, 51700 P (screw No. 94) - - - - | 37 |
| 51170 C | Needle Thread Take-up Post - - - - | 24 |
| 51170 D | " " " " Lock Nut - - - - | 25 |
| 51170 F | " " " Wire, for Style 51400 G (screw No. 90) - - - - | 39 |

LIST OF PARTS

| Symbol to Order By | The figures in the last column refer only to the plates illustrating the parts and are not to be used in ordering. Prices furnished on application. | Plate No. |
|--------------------|--|-----------|
| 51190 D | Main Shaft Bearing Housing Gasket, for Styles 51200 K, 51200 L, 51200 M, 51200 N, 51200 R, 51200 S, 51200 T, 51400 P, 51400 Q, 51400 R, 51400 S, 51400 T, 51400 U, 51400 V, 51400 W, 51400 X, 51400 Y, 51400 AA, 51400 AB, 51700 J, 51700 K, 51700 L, 51700 M, 51700 N, 51700 P, 51700 Q, 51700 R, 51700 U- - - - - | 57 |
| 51201 B | Cloth Plate, for Styles 51200 A, 51200 B, 51200 D, No. 32 gauge Style 51400 D, Style 51400 F, using throat plates 3 1/8 inches long (screw No. 80) - - - - - | 60 |
| 51201 C | Cloth Plate, for Styles 51400 P, 51400 T, 51400 U, 51400 X, 51400 Y, using throat plates 3 1/8 inches long (screw, 33/64 inch long, No. 80, screw, 21/32 inch long, No. 22574)- - - - - | 60 |
| 51201 E | Cloth Plate, for Styles 51200 U, 51200 V (screw No. 80)- - - - - | 60 |
| 51202 | Cloth Plate Slide, rear 1 1/2 inches long, for Styles 51200 A, 51200 B, 51200 C, 51200 D, 51200 G, 51200 H, 51200 J, 51400 A, 51400 B, 51400 C, 51400 D, 51400 E, 51400 F, 51400 H, 51400 J, 51400 K, 51400 M, 51400 N, 51400 AC, 51600 A, 51700 C, 51700 D, 51700 E, 51700 F, 51700 G, 51700 H, 51700 T (stop screw No. 22799 N)- - - - - | 49 |
| 51202 A | Cloth Plate Sliding Cover, for Styles 51200 U, 51200 V- - - - - | 49 |
| 51205 A | Feed Dog, for Styles 51200 A, 51200 K - - - - - | 8 |
| 51205 D | Feed Dog, for Styles 51200 D, 51200 N - - - - - Feed Dog Screw No. 22528 | 8 |
| 51208 | Looper, for Styles 51200 C, 51200 M - - - - - | 16 |
| 51208 D | Looper for Styles 51200 D, 51200 H, 51200 J, 51200 N, 51200 P, 51200 S, 51200 T, 51200 U, 51200 V, also back looper for Styles 51400 H, 51400 V - - - - - | 16 |
| 51213 | Looper Set Screw No. 73 | |
| 51213 | Looper Rocker, for styles in Class 51200- - - - - | 41 |
| *51215 A | Needle Lever, steel, includes bushing No. 51250 A for Styles 51200 A, 51200 B, 51200 C, 51200 D, 51200 G, 51200 H, 51200 J, 51200 U, 51200 V - - - - - | 58 |
| *51215 C | Needle Lever, lynite, includes bushing No. 51250 A for styles in Class 51400, 51700, Styles 51200 K, 51200 L, 51200 M, 51200 N, 51200 R, 51200 S, 51200 T, 51600 A- - - - - | 58 |

LIST OF PARTS

| Symbol to Order By | The figures in the last column refer only to the plates illustrating the parts and are not to be used in ordering. Prices furnished on application. | Plate No. |
|--------------------|--|-----------|
| 51235 A | Feed Rocker Arm, for Class 51700, Styles 51200 A, 51200 B, 51200 C, 51200 D, 51200 G, 51200 H, 51200 J, 51200 K, 51200 L, 51200 M, 51200 N, 51200 R, 51200 S, 51200 T, 51200 U, 51400 A, 51400 B, 51400 C, 51400 D, 51400 E, 51400 F, 51400 G, 51400 H, 51400 J, 51400 K, 51400 M, 51400 N, 51400 P, 51400 Q, 51400 R, 51400 S, 51400 T, 51400 U, 51400 V, 51400 W, 51400 X, 51400 Y, 51400 AA, 51400 AB (clamp screw No. 22519 C, washer No. 51235 G) - - - | 41 |
| 51235 B | Feed Rocker Shaft, 4 7/16 inches long, for Class 51700, Styles 51200 A, 51200 B, 51200 C, 51200 D, 51200 G, 51200 H, 51200 J, 51200 K, 51200 L, 51200 M, 51200 N, 51200 R, 51200 S, 51200 T, 51400 A, 51400 B, 51400 C, 51400 D, 51400 E, 51400 F, 51400 G; 51400 H, 51400 J, 51400 K, 51400 M, 51400 N, 51400 P, 51400 Q, 51400 R, 51400 S, 51400 T, 51400 U, 51400 V, 51400 W, 51400 X, 51400 Y, 51400 AA, 5.400 AB - - - | 45 |
| 51235 G | Feed Rocker Arm Clamp Screw Washer - - - - - | 26 |
| 51235 M | Differential Feed Regulating Lever - - - - - | 31 |
| 51235 N | Differential Feed Regulating Segment Plate, for Style 51200 V (screw No. 22848, nut No. 9937) | 31 |
| 51235 P | Differential Feed Regulating Thumb Screw - - - - - | 43 |
| 51235 Q | Differential Feed Regulating Screw Support Bracket (attaching screw No. 9663) - - - - - | 31 |
| 51235 R | Ratchet Nut, for differential feed regulating screw (lock nut No. 258) - - - - - | 25 |
| 51235 S | Differential Feed Regulating Ratchet Spring (screw No. 28) - - - - - | 32 |
| 51236 | Feed Crank Link (oil wick No. 666-19, shim No. 1248, screw No. 22569, nut No. 7947) - - - - - | 28 |
| 51236 A | Feed Lift Link Pin; also looper avoid link pin, (screw No. 77) - - - - - | 29 |
| 51236 B | Stitch Regulating Stud Cap (screw No. 22768) - - - - - | 31 |
| 51236 C | Feed Crank Stud (nut No. 269) - - - - - | 30 |
| 51239 A | Roller Feed Clutch Stationary Lever, for Styles 51200 U, 51200 V - - - - - | 43 |
| 51239 B | Roller Feed Clutch Stationary Lever Locking Pin (screw No. 22560 A) - - - - - | 29 |
| 51239 C | Roller Feed Clutch Shaft, for Styles 51200 U, 51200 V - - - - - | 30 |
| 51239 D | Roller Feed Driving Gear, for Styles 51200 U, 51200 V, (set screw No. 95) - - - - - | 28 |
| 51239 E | Roller Feed Driven Gear, for Styles 51200 U, 51200 V (set screw No. 22580) - - - - - | 28 |
| 51239 F | Roller Feed Driving Shaft, for Style 51200 U, 51200 V - - - - - | 30 |
| 51239 G | Roller Feed Universal Joint, for Styles 51200 U, 51200 V (set screw No. 22580) - - - - - | 28 |

LIST OF PARTS

| Symbol to Order By | The figures in the last column refer only to the plates illustrating the parts and are not to be used in ordering. Prices furnished on application. | Plate No. |
|--------------------------|--|--------------|
| 51216 | Needle Lever Connecting Rod Tube (nut, left thread, No. 15430 C, nut right thread, No. 15430 D) - - - - - | 46 |
| 51216 A | Needle Lever Connecting Rod Upper Bearing (screw No. 97 A) - - - - - | 41 |
| 51217 | Needle Bar, for Styles 51200 A, 51200 B, 51200 C, 51200 D, 51200 G, 51200 H, 51200 J, 51200 K, 51200 L, 51200 M, 51200 N, 51200 R, 51200 S, 51200 T (set screw No. 88 A) - - - - - | 44 |
| 51217 A | Needle Bar, for Styles 51200 U, 51200 V, needle set screw No. 22819) - - - - - | 44 |
| 51220 A | Presser Foot, for Styles 51200 A, 51200 K (clamp screw No. 91) - - - - - | 10 |
| 51220 J | Presser Foot, for Styles 51200 J, 51200 T (clamp screw No. 91, yielding side spring No. 11534, yielding side spring attaching screw No. 605, yielding side spring support screw No. 187 A) - - - - - | 10 |
| 51221 | Pulley, grooved for round belt, working diameter 2 1/2 inches, for styles in Class 51400, Styles 51200 A, 51200 D, 51200 G, 51200 H, 51200 K, 51200 L, 51200 M, 51200 N, 51200 R, 51200 S, 51200 T, 51700 C, 51700 D, 51700 E, 51700 G, 51700 H, 51700 J, 51700 K, 51700 L, 51700 N, 51700 P, 51700 Q, 51700 R (spot screw No. 22597, set screw No. 22597 A) - - - - - | 43 |
| 51222 | Main Shaft, left section, for Classes 51200, 51400 - - - - - | 57 |
| 51224 A | Throat Plate, for Styles 51200 A, 51200 K - - - - - | 3 |
| 51224 B | Throat Plate, for Styles 51200 B, 51200 L - - - - - | 3 |
| 51224 D | Throat Plate, for Styles 51200 D, 51200 N - - - - - | 3 |
| | Throat Plate Screws No. 22570 | |
| 51225 | Needle Rear Guard, for Styles 51200 A, 51200 B, 51200 C, 51200 D, 51200 G, 51200 H, 51200 J, 51200 K, 51200 L, 51200 M, 51200 N, 51200 R, 51200 S, 51200 T, 51200 U (screw No. 22858 B, washer No. 39236 A) - - - - - | 16 |
| 51235 | Feed Rocker, for Styles 51200 A, 51200 B, 51200 C, 51200 D, 51200 G, 51200 H, 51200 J, 51200 K, 51200 L, 51200 M, 51200 N, 51200 R, 51200 S, 51200 T, 51200 U, 51400 A, 51400 B, 51400 C, 51400 D, 51400 E, 51400 F, 51400 G, 51400 H, 51400 J, 51400 K, 51400 M, 51400 N, 51400 P, 51400 Q, 51400 R, 51400 S, 51400 T, 51400 U, 51400 V, 51400 W, 51400 X, 51400 Y, 51400 AA, 51400 AB, 51700 C, 51700 D, 51700 E, 51700 F, 51700 G, 51700 H, 51700 J, 51700 K, 51700 L, 51700 N, 51700 P, 51700 Q, 51700 R, 51700 T (screw No. 98) - - - - - | 42 |

LIST OF PARTS

| Symbol to Order By | The figures in the last column refer only to the plates illustrating the parts and are not to be used in ordering. Prices furnished on application. | Plate No. |
|--------------------|--|-----------|
| 51239 H | Roller Feed Intermediate Driving Shaft, for Styles 51200 U, 51200 V- - - - - | 30 |
| 51239 J | Roller Feed Clutch Bracket, for Styles 51200 U, 51200 V (attaching screw No. 318) | 57 |
| 15727 51239 K | Roller Feed Clutch Gear Cover, for Styles 51200 U, 51200 V (screw No. 22848) - - - - | 61 |
| *51239 L | Roller Feed Clutch Driving Lever Ball Joint Assembly, for Styles 51200 U, 51200 V (washer No. 9255, nut No. 39141 G) - - - - | 29 |
| 51240 A | Looper Connecting Rod, adjusting section, for styles in Classes 51200, 51400, Nos. 32 and 40 gauge Style 51700 L (nut, right thread, No. 18, nut, left thread, No. 269) | 30 |
| 51240 B | Looper Connecting Rod Jointed Section Sleeve, for styles in Classes 51200, 51400, Nos. 32 and 40 gauge Style 51700 L - - - - - | 26 |
| 51240 C | Looper Connecting Rod Jointed Section Sleeve Spring, for styles in Classes 51200, 51400, Nos. 32 and 40 gauge Style 51700 L - - - - | 32 |
| *51241 | Looper Connecting Rod, jointed section and ball joint assembly, right, for styles in Classes 51200, 51400, Nos. 32 and 40 gauge Style 51700 L, equipped with looper drive levers Nos. 51242 E, 51242 J, 51242 T, 51242 V (ball stud washer No. 36 G, bearing screw No. 97 A, jointed section sleeve No. 51240 B, sleeve spring No. 51240 C) - - - - | 41 |
| *51241 D | Looper Connecting Rod Ball Joint Assembly, left, for Styles in Classes 51200, 51400, Nos. 32 and 40 gauge Style 51700 L, equipped with looper drive levers Nos. 51242 E, 51242 J, 51242 T, 51242 V (bearing screw No. 97 A, nut No. 18) - - - - - | 29 |
| *51241 G | Looper Connecting Rod, jointed section and ball joint assembly, right, .232 inch diameter shoulder on ball stud, for styles in Classes 51200, 51400, Nos. 32 and 40 gauge Style 51700 L, equipped with looper drive levers Nos. 51242 N, 51242 U (ball stud washer No. 51741 E, bearing screw No. 97 A, jointed section sleeve No. 51240 B, sleeve spring No. 51240 C) - - - - - | 41 |
| *51242 A | Looper Drive Lever Shaft, 4 9/16 inches long, with bushing, for Styles 51200 A, 51200 B, 51200 C, 51200 D, 51200 G, 51200 H, 51200 J, 51200 U, 51200 V, 51400 A, 51400 B, 51400 C, 51400 D, 51400 E, 51400 F, 51400 G, 51400 H, 51400 J, 51400 K, 51400 M, 51400 N, 51400 AC, 51600 A, 51700 C, 51700 D, 51700 E, 51700 F, 51700 G, 51700 H, 51700 T (screw No. 22597 A) - - - - - | 45 |

LIST OF PARTS

| Symbol to Order By | The figures in the last column refer only to the plates illustrating the parts and are not to be used in ordering. Prices furnished on application. | Plate No. |
|--------------------|--|-----------|
| 51242 B | Looper Drive Lever Shaft Bushing, rear, for Styles 51200 A, 51200 B, 51200 C, 51200 D, 51200 G, 51200 H, 51200 J, 51200 U, 51200 V, 51400 A, 51400 B, 51400 C, 51400 D, 51400 E, 51400 F, 51400 G, 51400 H, 51400 J, 51400 K, 51400 M, 51400 N, 51400 AC, 51600 A, 51700 C, 51700 D, 51700 E, 51700 F, 51700 G, 51700 H, 51700 T (screw No. 22597 A) - - - | 26 |
| 51242 H | Looper Drive Lever Shaft, for Styles 51200 K, 51200 L, 51200 M, 51200 N, 51200 R, 51200 S, 51200 T, 51400 P, 51400 Q, 51400 R, 51400 S, 51400 T, 51400 U, 51400 V, 51400 W, 51400 X, 51400 Y, 51400 AA, 51400 AB, 51700 J, 51700 K, 51700 L, 51700 M, 51700 N, 51700 P, 51700 Q, 51700 R, 51700 U - - - | 45 |
| 51242 K | Looper Drive Lever Rocker, for Styles 51200 K, 51200 L, 51200 M, 51200 N, 51200 R, 51200 S, 51200 T, 51400 P, 51400 Q, 51400 R, 51400 S, 51400 T, 51400 U, 51400 V, 51400 W, 51400 X, 51400 Y, 51400 AA, 51400 AB, 51700 J, 51700 K, 51700 L, 51700 M, 51700 N, 51700 P, 51700 Q, 51700 R, 51700 U (set screw No. 81, clamp screw No. 627) - - | 41 |
| 51242 L-595 | Looper Drive Lever Rocker Thrust Washer, .0595 inch thick, for Styles 51200 K, 51200 L, 51200 M, 51200 N, 51200 R, 51200 S, 51200 T, 51400 P, 51400 Q, 51400 R, 51400 S, 51400 T, 51400 U, 51400 V, 51400 W, 51400 X, 51400 Y, 51400 AA, 51400 AB, 51700 J, 51700 K, 51700 L, 51700 M, 51700 N, 51700 P, 51700 Q, 51700 R, 51700 U - - - - - | 26 |
| 51242 L-600 | Looper Drive Lever Rocker Thrust Washer, .0600 inch thick - - - - - | 26 |
| 51242 L-605 | Looper Drive Lever Rocker Thrust Washer, .0605 inch thick - - - - - | 26 |
| 51242 L-610 | Looper Drive Lever Rocker Thrust Washer, .0610 inch thick - - - - - | 26 |
| 51242 L-615 | Looper Drive Lever Rocker Thrust Washer, .0615 inch thick - - - - - | 26 |
| 51242 L-620 | Looper Drive Lever Rocker Thrust Washer, .0620 inch thick - - - - - | 26 |

LIST OF PARTS

| Symbol to Order By | The figures in the last column refer only to the plates illustrating the parts and are not to be used in ordering. Prices furnished on application. | Plate No. |
|--------------------|---|-----------|
| 51242 M | Looper Drive Lever Clamp Screw Washer, for Styles 51200 K, 51200 L, 51200 M, 51200 N, 51200 R, 51200 S, 51200 T, 51400 P, 51400 Q, 51400 R, 51400 S, 51400 T, 51400 U, 51400 V, 51400 W, 51400 X, 51400 Y, 51400 AA, 51400 AB, 51700 J, 51700 K, 51700 L, 51700 M, 51700 N, 51700 P, 51700 Q, 51700 R, 51700 U- | 26 |
| 51242 N | Looper Drive Lever, steel, with .232 inch diameter reamed hole, for ball stud, clamping lug on left, for Styles 51200 K, 51200 L, 51200 M, 51200 N, 51200 R, 51200 S, 51200 T, 51400 P, 51400 Q, 51400 R, 51400 S, 51400 T, 51400 U, 51400 V, 51400 W, 51400 X, 51400 Y, 51400 AA, 51400 AB, 51700 J, 51700 K, 51700 L, 51700 M, 51700 N, 51700 P, 51700 Q, 51700 R, 51700 U (spot screw No. 81, clamping screw No. 22882 A, washer No. 51242 M)- | 41 |
| 51242 Q | Looper Drive Lever Shaft Bushing, front, for Styles 51200 K, 51200 L, 51200 M, 51200 N, 51200 R, 51200 S, 51200 T, 51400 P, 51400 Q, 51400 R, 51400 S, 51400 T, 51400 U, 51400 V, 51400 W, 51400 X, 51400 Y, 51400 AA, 51400 AB, 51700 J, 51700 K, 51700 L, 51700 M, 51700 N, 51700 P, 51700 Q, 51700 R, 51700 U- | 21 |
| 51242 R | Looper Drive Lever Shaft Bushing, middle, for Styles 51200 K, 51200 L, 51200 M, 51200 N, 51200 R, 51200 S, 51200 T, 51400 P, 51400 Q, 51400 R, 51400 S, 51400 T, 51400 U, 51400 V, 51400 W, 51400 X, 51400 Y, 51400 AA, 51400 AB, 51700 J, 51700 K, 51700 L, 51700 M, 51700 N, 51700 P, 51700 Q, 51700 R, 51700 U- | 26 |
| 51242 S | Looper Drive Lever Shaft Bushing, rear for Styles 51200 K, 51200 L, 51200 M, 51200 N, 51200 R, 51200 S, 51200 T, 51400 P, 51400 Q, 51400 R, 51400 S, 51400 T, 51400 U, 51400 V, 51400 W, 51400 X, 51400 Y, 51400 AA, 51400 AB, 51700 J, 51700 K, 51700 L, 51700 M, 51700 N, 51700 P, 51700 Q, 51700 R, 51700 U- | 26 |
| 51242 T | Looper Drive Lever, steel, with threaded hole for ball stud, for Styles 51200 A, 51200 B, 51200 C, 51200 D, 51200 G, 51200 H, 51200 J, 51200 U, 51200 V, 51400 A, 51400 B, 51400 C, 51400 D, 51400 E, 51400 F, 51400 G, 51400 H, 51400 J, 51400 K, 51400 M, 51400 N, 51400 AC, 51600 A, 51700 C, 51700 D, 51700 E, 51700 F, 51700 G, 51700 H, 51700 T- | 41 |

LIST OF PARTS

| Symbol to Order By | The figures in the last column refer only to the plates illustrating the parts and are not to be used in ordering. Prices furnished on application. | Plate No. |
|--------------------|--|-----------|
| 51242 U | Looper Drive Lever, steel, with .232 inch diameter reamed hole for ball stud, for Styles 51200 A, 51200 B, 51200 C, 51200 D, 51200 G, 51200 H, 51200 J, 51200 U, 51200 V, 51400 A, 51400 B, 51400 C, 51400 D, 51400 E, 51400 F, 51400 G, 51400 H, 51400 J, 51400 K, 51400 M, 51400 N, 51400 AC, 51600 A, 51700 C, 51700 D, 51700 E, 51700 F, 51700 G, 51700 H, 51700 T- | 41 |
| 51242 V | Looper Drive Lever, steel, with threaded hole for ball stud, for Styles 51200 K, 51200 L, 51200 M, 51200 N, 51200 R, 51200 S, 51200 T, 51400 P, 51400 Q, 51400 R, 51400 S, 51400 T, 51400 U, 51400 V, 51400 W, 51400 X, 51400 Y, 51400 AA, 51400 AB, 51700 J, 51700 K, 51700 L, 51700 M, 51700 N, 51700 P, 51700 Q, 51700 R, 51700 U (spot screw No. 81, clamp screw No. 74, washer No. 51242 M) | 41 |
| 51243 B | Looper Drive Lever Rocker Ball Stud, also needle lever ball stud (clamp screw, fillister head, No. 22528, clamp screw, hexagonal head, No. 22519) | 30 |
| 51243 C | Looper Drive Lever Ball Stud Guide Fork; also for No. 51216 A (screw No. 97) | 28 |
| 51243 E | Looper Drive Lever Connection Felt Retainer, for Looper drive eccentric assemblies Nos. 29105 A, 29105 B | 19 |
| 51243 K | Looper Drive Eccentric Oil Disc, for looper drive eccentric assemblies Nos. 29105 L, 29105 M (screw No. 22716) | 41 |
| 51243 L | Looper Drive Eccentric Oil Disc Gasket, for looper drive eccentric assemblies Nos. 29105 L, 29105 M | 41 |
| 51243 N | Looper Drive Eccentric Oil Disc Washer, steel, for looper drive eccentric assemblies Nos. 29105 L, 29105 M (screw No. 22716 A) | 41 |
| 51243 R | Looper Drive Eccentric Felt Retainer, for looper drive eccentric assemblies Nos. 29105 L, 29105 M | 19 |
| 51244 | Looper Rocker Frame, for styles in Classes 51200, 51400, (spot screw No. 96, set screw No. 98) | 41 |
| 51244 A | Looper Rock Shaft | 45 |
| 51244 B | Looper Rock Shaft Arm (clamp screw No. 93) | 28 |
| 51244 C | Looper Rock Shaft Sleeve, for styles in Class 51200, Styles 51400 A, 51400 B, 51400 C, 51400 D, 51400 E, 51400 F, 51400 H, 51400 J, 51400 K, 51400 M, 51400 N, 51400 P, 51400 Q, 51400 R, 51400 S, 51400 T, 51400 U, 51400 V, 51400 W, 51400 X, 51400 Y, 51400 AA, 51400 AB, 51400 AC, 51600 A (screw No. 88 B) | 27 |

LIST OF PARTS

| Symbol to Order By | The figures in the last column refer only to the plates illustrating the parts and are not to be used in ordering. Prices furnished on application. | Plate No. |
|--------------------|--|-----------|
| 51244 E | Looper Rock Shaft Bushing, also feed rocker shaft bushing- - - - - | 26 |
| 51245 | Looper Avoid Eccentric Link and Feed Lift Eccentric Link, for Styles 51200 A, 51200 B, 51200 C, 51200 D, 51200 G, 51200 H, 51200 J, 51200 U, 51200 V, 51400 A, 51400 B, 51400 C, 51400 D, 51400 E, 51400 F, 51400 G, 51400 H, 51400 J, 51400 K, 51400 M, 51400 N, 51400 AC, 51600 A, 51700 C, 51700 D, 51700 E, 51700 F, 51700 G, 51700 H, 51700 T (oil retaining pad No. 51245 A, screw No. 22569, nut No. 7947)- - - - - | 28 |
| 51245 A | Looper Avoid Eccentric Link Oil Retaining Pad- | 19 |
| 51246 | Looper Rocker Stud Nut, for styles in Classes 51200, 51400, Style 51600 A- - - - - | 25 |
| 51250 | Needle Lever Stud (screw No. 719)- - - - - | 45 |
| 51250 A | " " " Bushing - - - - - | 27 |
| 51250 B | " " Thrust Collar (screw No. 719) - - - - - | 27 |
| 51250 C | " " Link Pin Clamp Screw Nut, for styles in Classes 51400, 51700, Styles 51200K, 51200 L, 51200 M, 51200 N, 51200 R, 51200 S, 51200 T, 51600 A - - - - - | 25 |
| 51254 | Needle Bar Bushing, upper- - - - - | 27 |
| 51254 A | Needle Bar Bushing, lower- - - - - | 27 |
| 51257 A | Presser Bar Bushing, upper, for Styles 51200 A, 51200 B, 51200 C, 51200 D, 51200 G, 51200 H, 51200 J, 51200 U, 51200 V, 51400 A, 51400 B, 51400 C, 51400 D, 51400 E, 51400 F, 51400 G, 51400 H, 51400 J, 51400 K, 51400 M, 51400 N, 51400 AC, 51600 A, 51700 C, 51700 D, 51700 E, 51700 F, 51700 G, 51700 H, 51700 T - - - - - | 27 |
| 51257 C | Presser Bar Bushing, lower, length overall 1 3/4 inches, for Styles 51200 A, 51200 B, 51200 C, 51200 D, 51200 G, 51200 H, 51200 J, 51400 A, 51400 B, 51400 C, 51400 D, 51400 E, 51400 F, 51400 H, 51400 J, 51400 K, 51400 M, 51400 N, 51700 C, 51700 D, 51700 E, 51700 F, 51700 G, 51700 H - - - - - | 27 |
| 51257 D | Presser Bar Bushing, lower, for Styles 51200 K, 51200 L, 51200 M, 51200 N, 51200 R, 51200 S, 51200 T, 51400 P, 51400 Q, 51400 R, 51400 S, 51400 T, 51400 U, 51400 V, 51400 W, 51400 X, 51400 Y, 51400 AA, 51400 AB, 51700 J, 51700 K, 51700 L, 51700 M, 51700 N, 51700 P, 51700 Q, 51700 R, 51700 U- - - - - | 27 |
| 51258 | Needle Lever Thread Eyelet, for styles in Class 51200 (screw No. 22768)- - - - - | 18 |
| 51258 A | Needle Bar Thread Eyelet, for styles in Class 51200 (screw No. 22768)- - - - - | 18* |
| 51264 | Cloth Plate Swinging Arm, for Styles 51200 U, 51200 V (pivot screw No. 236)- - - - - | 61 |

LIST OF PARTS

| Symbol to Order By | The figures in the last column refer only to the plates illustrating the parts and are not to be used in ordering. Prices furnished on application. | Plate No. |
|--------------------|--|-----------|
| 51270 B | Needle Thread Take-up, for styles in Classes 51200, 51700, Styles 51400 A, 51400 B, 51400 C, 51400 D, 51400 E, 51400 F, 51400 H, 51400 J, 51400 K, 51400 M, 51400 N, 51400 P, 51400 Q, 51400 R, 51400 S, 51400 T, 51400 U, 51400 V, 51400 W, 51400 X, 51400 Y, 51400 AA, 51400 AB, 51400 AC, 51600 A (clamping screw No. 90) - - - - - | 39 |
| 51280 A | Throat Plate Support, for Styles 51200 C, 51200 G, 51200 H, 51200 J, 51200 M, 51200 R, 51200 S, 51200 T, 51400 H, 51400 J, 51400 V, 51400 W, 51700 M, (screw No. 80) - - - - - | 55 |
| 51280 B | Throat Plate Support for Styles 51700 E, 51700 L (screw No. 22839) - - - - - | 56 |
| 51280 G | Throat Plate Support, for Style 51400 G (screw No. 80) - - - - - | 55 |
| 51281-199 | Cloth Plate Cover, 6 7/32 inches long, for Styles 51700 G, 51700 H - - - - - | 56 |
| 51281-204 | Cloth Plate Cover, 6 17/64 inches long, for Styles 51700 E, 51700 F, Nos. 64, 72, 80 gauge Style 51700 L, 51700 M - - - - - | 56 |
| 51281-206 | Cloth Plate Cover, 6 27/64 inches long, for Styles 51700 T, 51700 U - - - - - | 56 |
| 51281-216 | Cloth Plate Cover, 6 3/4 inches long, for Styles 51200 J, 51400 B, 51400 C, No. 48 gauge Style 51400 D, Styles 51400 M, 51400 N, 51700 C, 51700 D - - - - - | 56 |
| 51281-226 | Cloth Plate Cover, 7 1/16 inches long, for No. 32 gauge Styles 51400 D, 51400 F - - - - - | 56 |
| 51281-228 | Cloth Plate Cover, 7 1/8 inches long, for Style 51200 C, No. 18 gauge Styles 51400 G, 51400 H - - - - - | 56 |
| 51281-230 | Cloth Plate Cover, 7 3/16 inches long for No. 24 gauge Style 51400 G - - - - - | 56 |
| 51281-232 | Cloth Plate Cover, 7 1/4 inches long, for No. 16 gauge, Style 51400 G - - - - - | 56 |
| 51281-233 | Cloth Plate Cover, 7 9/32 inches long, for Styles 51200 G, 51400 H, 51400 J, 51600 A - - - - - | 56 |
| 51281 C-226 | Cloth Plate Cover, 7 1/16 inches long, for Styles 51200 A, 51200 B, 51200 K, 51200 L - - - - - | 56 |
| 51281 E-226 | Cloth Plate Cover, 7 1/16 inches long, for Styles 51200 D, 51200 N - - - - - | 56 |
| 51281 F | Cloth Plate Cover Spring, for Styles 51200 A, 51200 B, 51200 C, 51200 D, 51200 G, 51200 H, 51200 J, 51400 B, 51400 C, 51400 D, 51400 F, 51400 G, 51400 H, 51400 J, 51400 M, 51400 N, 51600 A, 51700 C, 51700 D, 51700 E, 51700 F, 51700 G, 51700 H, 51700 T, (screw No. 22726 A) - - - - - | 49 |

LIST OF PARTS

| Symbol to Order By | The figures in the last column refer only to the plates illustrating the parts and are not to be used in ordering. Prices furnished on application. | Plate No. |
|--------------------|--|-----------|
| 51281 G | Cloth Plate Cover Spring, for Styles 51200 M, 51200 R, 51200 S, 51200 T, 51400 P, 51400 Q, 51400 R, 51400 S, 51400 T, 51400 U, 51400 V, 51400 W, 51400 X, 51400 Y, 51400 AA, 51400 AB, 51700 J, 51700 K, Nos. 32 and 40 gauge Style L, Styles 51700 N, 51700 P, 51700 Q, 51700 R, (attaching screw No. 22726, attaching screw washer No. 6042 A, pivot screw No. 22845 B)----- | 49 |
| 51281 H-187 | Cloth Plate Cover, for Styles 51400 Q, 51400 R, No. 48 gauge Style 51400 S, Styles 51400 AA, 51400 AB, 51700 J, 51700 K, 51700 Q, 51700 R----- | 48 |
| 51281 H-207 | Cloth Plate Cover, for Style 51400 P, No. 32 gauge Style 51400 S, Styles 51400 T, 51400 U, 51400 X, 51400 Y----- | 48 |
| 51281 J-190 | Cloth Plate Cover, for Style 51200 T----- | 48 |
| 51281 J-212 | Cloth Plate Cover, for Style 51200 M, No. 18 gauge Style 51400 V----- | 48 |
| 51281 J-219 | Cloth Plate Cover, for No. 16 gauge Style 51400 V----- | 48 |
| 51281 J-222 | Cloth Plate Cover, for Styles 51200 R, 51400 W----- | 48 |
| 51281 J-227 | Cloth Plate Cover, for Style 51200 S----- | 48 |
| 51281 M-155 | Cloth Plate Cover, for Styles 51700 N, 51700 P----- | 48 |
| 51282 | Louver Cover, for Style 51200 A, 51200 B, 51200 C, 51200 D, 51200 G, 51200 H, 51200 J, 51200 U, 51200 V, 51400 A, 51400 B, 51400 C, 51400 D, 51400 E, 51400 F, 51400 G, 51400 H, 51400 J, 51400 K, 51400 M, 51400 N, 51400 AC, 51600 A, 51700 C, 51700 D, 51700 E, 51700 F, 51700 G, 51700 H, 51700 T, (screw No. 90)----- | 49 |
| 51282 B | Face Plate, for styles in Classes 51400, 51700, Styles 51200 A, 51200 B, 51200 C, 51200 D, 51200 G, 51200 H, 51200 J, 51200 K, 51200 L, 51200 M, 51200 N, 51200 R, 51200 S, 51200 T (thumbscrew No. 22837)----- | 48 |
| 51282 E | Crankshaft Chamber Cover, upper, for Styles 51200 K, 51200 L, 51200 M, 51200 N, 51200 R, 51200 S, 51200 T, 51400 P, 51400 Q, 51400 R, 51400 S, 51400 T, 51400 U, 51400 V, 51400 W, 51400 X, 51400 Y, 51400 AA, 51400 AB, 51700 J, 51700 K, 51700 L, 51700 M, 51700 N, 51700 P, 51700 Q, 51700 R, 51700 U (attaching screw, right, No.22849, attaching screw, left, No. 35768 A)--- | 56 |

LIST OF PARTS

| Symbol to Order By | The figures in the last column refer only to the plates illustrating the parts and are not to be used in ordering. Prices furnished on application. | Plate No. |
|--------------------|---|-----------|
| 51282 F | Crankshaft Cover Oil Drip Plate, for Styles 51200 K, 51200 L, 51200 M, 51200 N, 51200 R, 51200 S, 51200 T, 51400 P, 51400 Q, 51400 R, 51400 S, 51400 T, 51400 U, 51400 V, 51400 W, 51400 X, 51400 Y, 51400 AA, 51400 AB, 51700 J, 51700 K, 51700 L, 51700 M, 51700 N, 51700 P, 51700 Q, 51700 R, 51700 U (screw No. 187 A)- - | 47 |
| 51282 H | Crank Chamber Cover Gasket, for Styles 51200 A, 51200 B, 51200 C, 51200 D, 51200 G, 51200 H, 51200 J, 51200 U, 51200 V, 51400 A, 51400 B, 51400 C, 51400 D, 51400 E, 51400 F, 51400 G, 51400 H, 51400 J, 51400 K, 51400 M, 51400 N, 51400 AC, 51600 A, 51700 C, 51700 D, 51700 E, 51700 F, 51700 G, 51700 H, 51700 T- - - - - | 49 |
| 51282 J | Crank Chamber Oil Reservoir, for Styles 51200 A, 51200 B, 51200 C, 51200 D, 51200 G, 51200 H, 51200 J, 51200 U, 51200 V, 51400 A, 51400 B, 51400 C, 51400 D, 51400 E, 51400 F, 51400 G, 51400 H, 51400 J, 51400 K, 51400 M, 51400 N, 51400 AC, 51600 A, 51700 C, 51700 D, 51700 E, 51700 F, 51700 G, 51700 H, 51700 T (attaching screw, right, No. 22849, attaching screw, left No. 35768 A)- - - - - | 56 |
| 51282 L | Oil Reservoir Top Cover, for Styles 51200 K, 51200 L, 51200 M, 51200 N, 51200 R, 51200 S, 51200 T, 51400 P, 51400 Q, 51400 R, 51400 S, 51400 T, 51400 U, 51400 V, 51400 W, 51400 X, 51400 Y, 51400 AA, 51400 AB, 51700 J, 51700 K, 51700 L, 51700 M, 51700 N, 51700 P, 51700 Q, 51700 R, 51700 U (screw countersunk head, No. 22524, screw, fillister head, No. 22585 A)- - | 57 |
| 51282 M | Oil Reservoir Top Cover Gasket- - - - - | 57 |
| 51282 N | Oil Reservoir Top Cover Oil Drip Plate (screw No. 187 A) - - - - - | 46 |
| 51282 Q | Oil Reservoir Back Cover, for Styles 51700 M, 51700 N, 51700 U (screw No. 22848)- - - - - | 56 |
| 51282 R | Oil Reservoir Back Cover, for Styles 51200 K, 51200 L, 51200 M, 51200 N, 51200 R, 51200 S, 51200 T, 51400 P, 51400 Q, 51400 R, 51400 S, 51400 T, 51400 U, 51400 V, 51400 W, 51400 X, 51400 Y, 51400 AA, 51400 AB, 51700 J, 51700 K, 51700 L, 51700 P, 51700 Q, 51700 R (screw No. 22848)- - - - - | 56 |
| 51282 S | Oil Reservoir Back Cover Gasket, for Styles 51200 K, 51200 L, 51200 M, 51200 N, 51200 R, 51200 S, 51200 T, 51400 P, 51400 Q, 51400 R, 51400 S, 51400 T, 51400 U, 51400 V, 51400 W, 51400 X, 51400 Y, 51400 AA, 51400 AB, 51700 J, 51700 K, 51700 L, 51700 M, 51700 N, 51700 P, 51700 Q, 51700 R, 51700 U - - - - - | 57 |

LIST OF PARTS

| Symbol to Order By | The figures in the last column refer only to the plates illustrating the parts and are not to be used in ordering. Prices furnished on application. | Plate No. |
|--------------------|--|-----------|
| 51282 T | Crankshaft Chamber Cover, for Styles 51200 K, 51200 L, 51200 M, 51200 N, 51200 R, 51200 S, 51200 T, 51400 P, 51400 Q, 51400 R, 51400 S, 51400 T, 51400 U, 51400 V, 51400 W, 51400 X, 51400 Y, 51400 AA, 51400 AB, 51700 J, 51700 K, 51700 L, 51700 M, 51700 N, 51700 P, 51700 Q, 51700 R, 51700 U (screw No. 90) - - - | 48 |
| 51282 U | Crankshaft Chamber Cover Gasket, for Styles 51200 K, 51200 L, 51200 M, 51200 N, 51200 R, 51200 S, 51200 T, 51400 P, 51400 Q, 51400 R, 51400 S, 51400 T, 51400 U, 51400 V, 51400 W, 51400 X, 51400 Y, 51400 AA, 51400 AB, 51700 J, 51700 K, 51700 L, 51700 M, 51700 N, 51700 P, 51700 Q, 51700 R, 51700 U - - - - - | 49 |
| 51282 V | Oil Reservoir Baffle Plate, for Styles 51700 M, 51700 N, 51700 U (screw, front, No. 22874, screw, rear, No. 94) - - - - - | 47 |
| 51283 | Lifter Lever, for Styles 51200 A, 51200 B, 51200 C, 51200 D, 51200 G, 51200 H, 51200 J, 51400 A, 51400 B, 51400 C, 51400 D, 51400 E, 51400 F, 51400 H, 51400 J, 51400 K, 51400 M, 51400 N, 51700 C, 51700 D, 51700 E, 51700 F, 51700 G, 51700 H, (stud No. 22566 C) - - - - - | 61 |
| 51283 A | Lifter Lever Spring, for Styles 51200 A, 51200 B, 51200 C, 51200 D, 51200 G, 51200 H, 51200 J, 51400 A, 51400 B, 51400 C, 51400 D, 51400 E, 51400 F, 51400 H, 51400 J, 51400 K, 51400 M, 51400 N, 51700 C, 51700 D, 51700 E, 51700 F, 51700 G, 51700 H - - - - - | 32 |
| 51283 B | Lifter Lever Spring Pin, for Styles 51200 A, 51200 B, 51200 C, 51200 D, 51200 G, 51200 H, 51200 J, 51400 A, 51400 B, 51400 C, 51400 D, 51400 E, 51400 F, 51400 G, 51400 H, 51400 J, 51400 K, 51400 M, 51400 N, 51700 C, 51700 D, 51700 E, 51700 F, 51700 G, 51700 H - - - - - | 29 |
| 51283 E | Lifter Lever, for Styles 51200 K, 51200 L, 51200 M, 51200 N, 51200 R, 51200 S, 51200 T, 51400 P, 51400 Q, 51400 R, 51400 S, 51400 T, 51400 U, 51400 V, 51400 W, 51400 X, 51400 Y, 51400 AA, 51400 AB, 51700 J, 51700 K, 51700 L, 51700 M, 51700 N, 51700 P, 51700 Q, 51700 R, 51700 U (stud No. 22566 A) - - - - - | 61 |
| 51283 F | Lifter Lever Link, for Styles 51200 K, 51200 L, 51200 M, 51200 N, 51200 R, 51200 S, 51200 T, 51400 P, 51400 Q, 51400 R, 51400 S, 51400 T, 51400 U, 51400 V, 51400 W, 51400 X, 51400 Y, 51400 AA, 51400 AB, 51700 J, 51700 K, 51700 L, 51700 M, 51700 N, 51700 P, 51700 Q, 51700 R, 51700 U (screw No. 22758 B, stud No. 402) - - - - - | 28 |