



*Union Special*<sup>®</sup>  
LEWIS<sup>®</sup> • COLUMBIA<sup>®</sup>

INDUSTRIAL  
SEWING  
MACHINES

**LIST OF PARTS  
FOR  
STYLE 43400B**

The Edgelock Machines  
Forty-Three Thousand Series

**CATALOG No. 75M**  
(Supplement to Catalog No. 75L)

Includes all parts in Style 43400B  
that are not included in Catalog No. 75L

CLASS  
43400

CATALOG  
No.  
75M

**UNION SPECIAL CORPORATION**

CHICAGO



Catalog No. 75 M  
(Supplement to Catalog No. 75 L)

LIST OF PARTS  
FOR  
STYLE 43400 B  
The Edgelock Machines  
Forty-Three Thousand Series

DESCRIPTION OF STYLE 43400 B

For closing leather palm canvas, all canvas and all heavy weight leather gloves; seam Types SSa-1, SSj-1, SSk-1, 3/32 to 1/8 inch seam, double locked stitch Type 401, power driven upper running feed, under feed, five eccentrics on shaft, knee lifter, Type 106GS needle, stitch range 12 to 7 per inch, no welt gauge furnished.

Copyright 1938  
By  
Union Special Corporation  
Rights Reserved in All Countries

**UNION SPECIAL CORPORATION**  
INDUSTRIAL SEWING MACHINES  
**CHICAGO**

Printed in U. S. A.

March, 1978

Postage and insurance will be charged on all goods sent by mail. Prices are subject to change without notice. TERMS, NET CASH.

Symbol to Order By	Description
28 B	Set Screw, for needle on needle bar No. 43417 on Style 43400 B -----
75	Screw, for feed driving link No. 43446; also for No. 43439 on Style 43400 B -----
166	Screw, hexagonal head, for running feed bar guide stud No. 43447 A on Style 43400 B--
660-92	Washer, leather, 3/16 inch hole, for top of glass tube on oil level gauge No. 39193---
660-93	Washer, leather, 1/4 inch hole, for bottom of glass tube on oil level gauge No. 39193-
666-49	Glass Tube, for oil level gauge No. 39193-
666-79	Oil Cup Assembly, rear, with sight feed and signal stop, for Styles 43400 B -----
21396 BH	Oil Cup Assembly, front, with signal stop, for lubricating needle thread on Style 43400 B (screw No. 28) -----
22517 B	Screw, for running feed presser arm driving lever No. 43443 K on Style 43400 B---
22537	Screw, for looper drive shaft No. 43243 on Style 43400 B -----
22561	Screw, for needle bar link thread eyelet No. 43264 E on Style 43400 B-----
22571 B	Plug Screw, for rear oil cup assembly on Style 43400 B -----
22585 A	Screw, for upper feed dog; also for Nos. 43420, 43481 on Style 43400 B -----
22586 C	Screw, for No. 43446 on Style 43400 B----
22766	Screw, for oil reservoir cover No. 43165 on Style 43400 B -----
22804	Screw, for running feed presser arm driving lever link No. 43443 N on Style 43400 B -----
‡29126 AP	Lower Feed Lift Eccentric Assembly, includes eccentric No. 43406 B, throw .066 inch, for Style 43400 B (set screw No. 88, spot screw No. 22764, bearing screw No. 22587 E) -----
‡29126 AQ	Looper Drive Eccentric Assembly and Looper Avoid, includes eccentric No. 43448 B, throw .140 inch, for Style 43400 B (set screw No. 88, spot screw No. 22764, bearing screw No. 22587 E) -----

PLATE NO. 5

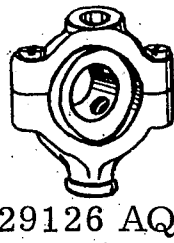
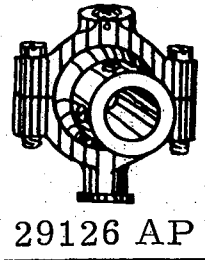
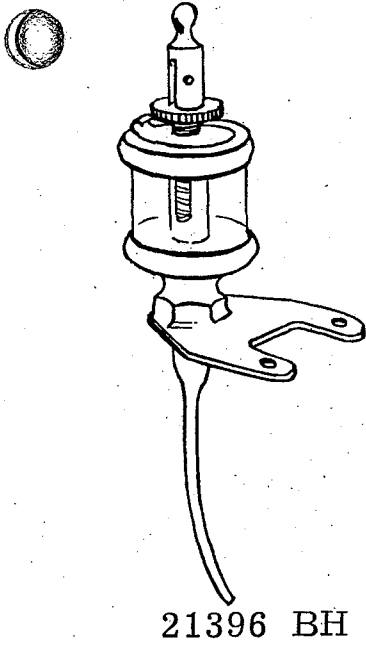
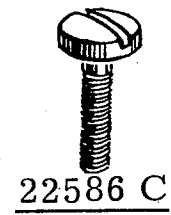
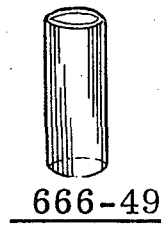
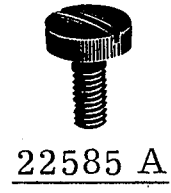
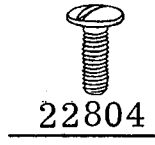
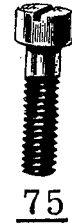
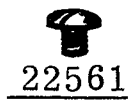
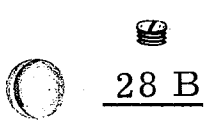

Postage and insurance will be charged on all goods sent by mail.  
 Prices are subject to change without notice. TERMS, NET CASH.

Symbol to Order By	Description
‡29126 AR	Running Feed Lift Eccentric Assembly, includes eccentric No. 43440 H, throw .200 inch, for Style 43400 B (set screw No. 88, spot screw No. 22764, bearing screw No. 22587 E, connecting stud No. 43442 P, upper connecting stud nut No. 43442 Q, lower connecting stud nut No. 269)-----
‡39145 E	Connecting Stud Ball Joint, for running feed lift eccentric assembly on Style 43400 B (screw No. 97 A) -----
39155 D	Lifter Lever Bushing, for Style 43400 B -
39193	Oil Level Gauge, for oil reservoir No. 43462 on Style 43400 B -----
39193 A	Oil Level Gauge Glass Tube Cover, for No. 39193-----
51225 W	Running Feed Bar Driving Link Washer, for Style 43400 B -----
39236 V	Running Feed Bar Driving Link Bushing --
39262 EA	Oil Reservoir Assembly, for Style 43400 B
‡43165	Oil Reservoir Cover and Lead-in Thread Eyelet, for Style 43400 B (screw No. 22766) -----
43242 H	Looper Drive Shaft Arm, rear, for Style 43400 B -----
43242 P	Nut, for No. 29126 AR on Style 43400 B --
43255 B	Lifter Lever, for Style 43400 B-----
43257 A	Presser Spring Regulator, for Style 43400 B-----
43257 N	Presser Spring Plunger Cap, for Style 43400 B-----
43257 U	Presser Spring Plunger Bearing, for Style 43400 B-----
43278 B	Fabric Guard, for Style 43400 B (screw No. 187 A) -----
43401	Cloth Plate, for Style 43400 B -----
43405 A	Lower Feed Dog, for Style 43400 B (attaching screw No. 22596, supporting screw No. 97) -----
43408 A	Looper, for Style 43400 B (screw No. 73)
43410	Looper Needle Guard, for Style 43400 B (screw No. 73 A) -----
43417	Needle Bar, for Style 43400 B (needle set screw No. 28 B) -----

PLATE NO. 7

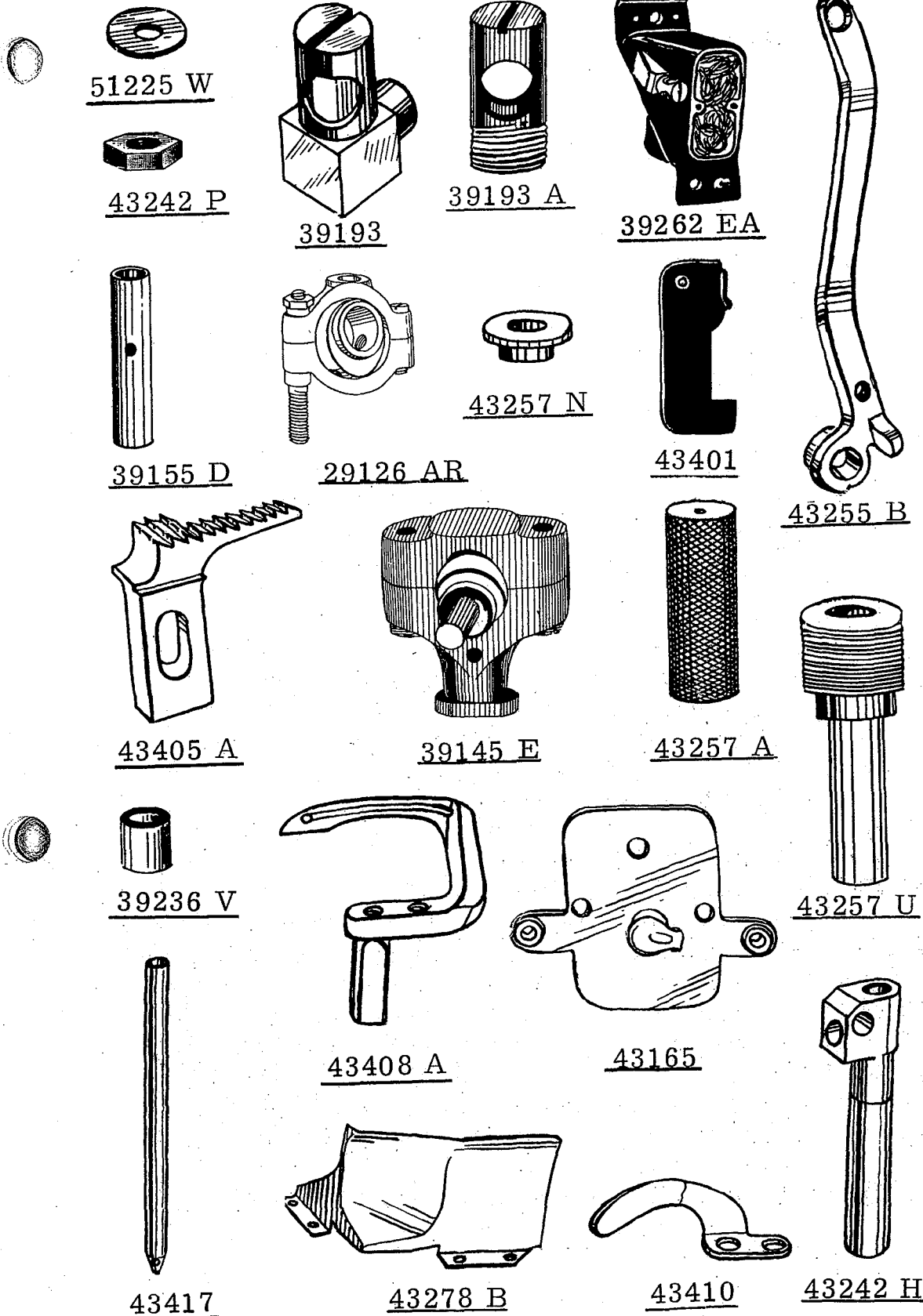

Postage and insurance will be charged on all goods sent by mail. Prices are subject to change without notice. TERMS, NET CASH.

Symbol to Order By	Description
43420	Presser Foot, for Style 43400 B (screw No. 22585 A)-----
43422 B	Main Shaft, including crank pin, for Style 43400 B-----
43424 A	Throat Plate, for Style 43400 B (screw No. 28)-----
43426	Upper Feed Dog, for Style 43400 B (screw No. 22585 A)-----
43434	Feed Bar, lower, for Style 43400 B (screw No. 94)-----
43439	Lower Feed Dog Holder, for Style 43400 B (adjusting screw No. 75, stop screw No. 97 for maintaining height of feed dog---
43440	Feed Rocker, for Style 43400 B-----
43440 D	Feed Rocker Segment Slot Plate (screw No. 93)-----
43442 P	Connecting Stud, for running feed lift eccentric assembly No. 29126 AR on Style 43400 B (nut, lower, No. 269)---
43442 Q	Connecting Stud Nut, upper, on No. 29126 AR-----
43443 A	Running Feed Presser Arm, for Style 43400 B-----
43443 G	Running Feed Presser Arm Driving Lever Bushing-----
43443 K	Running Feed Presser Arm Driving Lever (screw No. 22517 B)-----
43443 M	Running Feed Presser Arm Driving Lever Link, left (screw No. 22804)---
43443 N	Running Feed Presser Arm Driving Lever Link, right (screw No. 22804)---
43443 P	Running Feed Presser Arm Driving Lever Link Bushing-----
43443 Q	Running Feed Presser Arm Driving Lever Link Nut-----



PLATE NO. 9

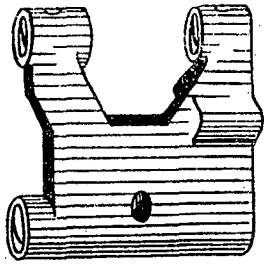

43440

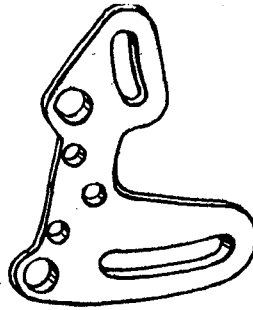

43440 D



43439



43443 P



43443 Q

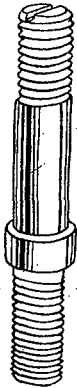

43442 P

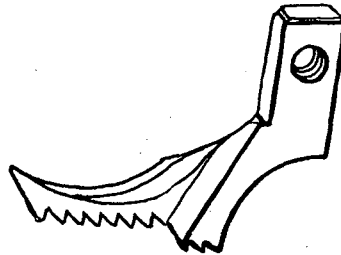

43426



43443 G



43442 Q



43443 K



43443 M

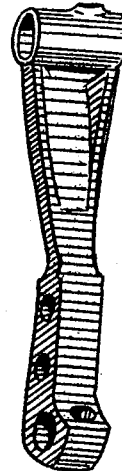

43434



43443 N

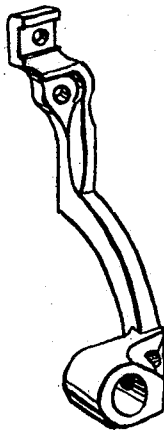

43443 A

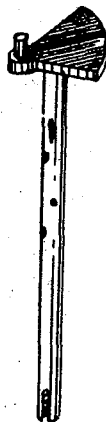

43422 B

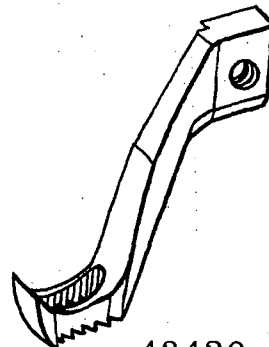

43420

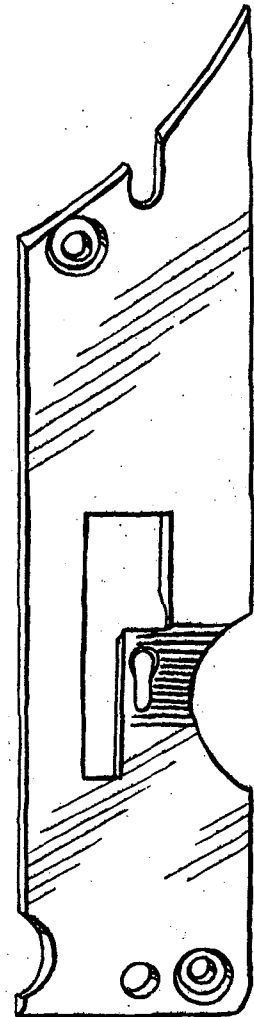

43424 A

Postage and insurance will be charged on all goods sent by mail. Prices are subject to change without notice. TERMS, NET CASH.

Symbol to Order By	Description
43444	Running Feed Bar, for Style 43400 B-----
43445	Running Feed Bar Holder, for Style 43400 B -----
43446	Running Feed Bar Driving Link (screw No. 75)-----
43447 A	Running Feed Bar Guide Stud (screw No. 166) -----
43447 H	Running Feed Bar Guide Stud Plate -----
43447 J	Shim, for running feed bar guide stud plate No. 43447 H, for Style 43400 B (thickness determined at assembly) -----
43452	Needle Bar Driving Stud, for Style 43400 B (screw No. 88)-----
43454	Needle Bar Connection Link (screw No. 22560)-----
43455	Lifter Lever Arm, for Style 43400 B (clamp screw No. 93, screw No. 719, nut No. 12934 A, spot screw No. 22519, screw No. 22542)-----
43457 C	Presser Spring Plunger -----
43457 D	Presser Spring, for Style 43400 B (regulating screw No. 22843) -----
43461	Needle Bar Cover, for Style 43400 B -----
43462 G	Side Cover, left, for Style 43400 B (screw No. 22848)-----
43464 B	Frame Needle Thread Pull-off, for Style 43400 B (screw No. 22768) -----
43464 C	Needle Bar Link Thread Eyelet, for needle thread on Style 43400 B (screw No. 87 U)-----
43481	Chain Cutting Knife, for Style 43400 B (screw No. 22585 A)-----
51242 M	Washer, for locking stud No. 52841 G, for Style 43400 B -----
51292 F-2	Tension Spring, .022 inch diameter wire, for looper thread on Style 43400 B-----
52841 G	Locking Stud, for Style 43400 B-----
52841 H	Nut, for locking stud No. 52841 G, for Style 43400 B -----
53542	Washer, for looper rocker shaft arm No. 43245 G, for Style 43400 B -----
55241 N	Looper Connecting Rod Ball Joint, left, for Style 43400 B -----

PLATE NO. 1.

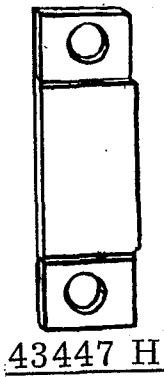

43447 H

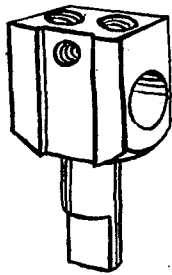

43452

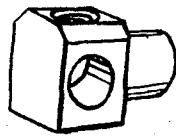

43447 A

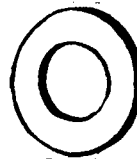

53542



43444

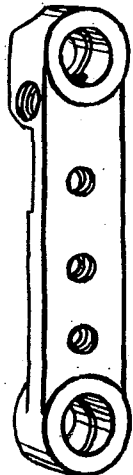

43454



43457 C

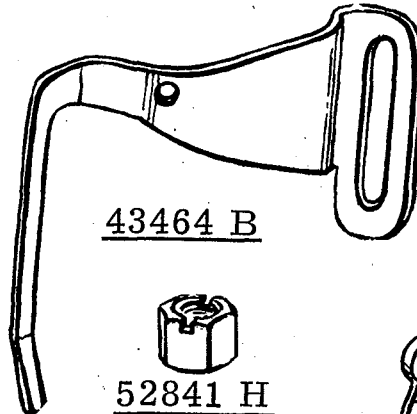

43464 B



52841 H

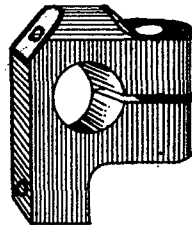

43455



43447 J



43446



43462 G



51242 M

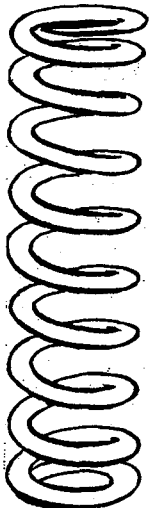

43457 D



51292 F-2

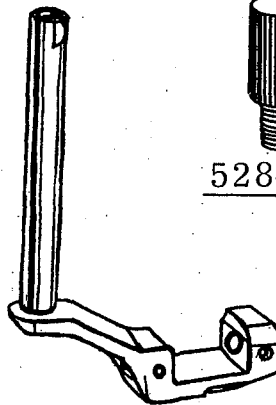

43445



52841 G

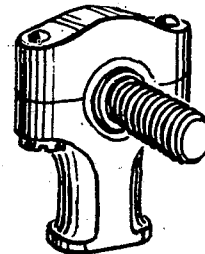

55241 N

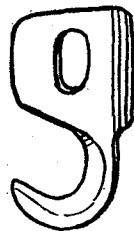

43481

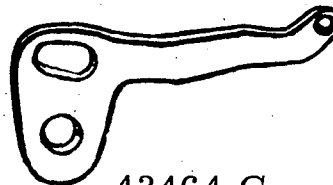

43464 C



43461



*Union Special*<sup>®</sup>  
INDUSTRIAL SEWING MACHINES

UNION SPECIAL maintains sales and service facilities throughout the world. These offices will aid you in the selection of the right sewing equipment for your particular operation. Union Special representatives and service men are factory trained and are able to serve your needs promptly and efficiently. Whatever your location, there is a Union Special Representative to serve you. Check with him today.

**ATLANTA, GA.**

**BOSTON, MASS.**

**CHICAGO, ILL.**

**DALLAS, TEXAS**

**LOS ANGELES, CAL.**

**NEW YORK, N. Y.**

**PHILADELPHIA, PA.**

**MONTREAL, CANADA**

**TORONTO, CANADA**

**BRUSSELS, BELGIUM**

**LEICESTER, ENGLAND**

**LONDON, ENGLAND**

**PARIS, FRANCE**

**STUTTART, GERMANY**

**Representatives and distributors in all important  
industrial cities throughout the world.**

**UNION SPECIAL CORPORATION**  
**400 N. FRANKLIN ST., CHICAGO, ILL. 60610**