

**SECOND
EDITION**



Union Special
INDUSTRIAL SEWING EQUIPMENT

CATALOG NO. 75L

STYLES

43200 A 43200 D
43200 B 43200 E
43200 C 43200 F
43800 A

LIST OF PARTS

THE EDGELOCK MACHINES
FORTY-THREE THOUSAND SERIES

— Catalog No. 75 L

LIST OF PARTS
FOR
STYLES IN CLASSES
43200 43800

THE FORTY-THREE THOUSAND SERIES

Second Edition

© 1936
By
Union Special Corporation
Rights Reserved in All Countries

UNION SPECIAL CORPORATION
INDUSTRIAL SEWING MACHINES
CHICAGO

Printed in U.S.A.

February, 1982

FOREWORD

The one dominating idea back of Union Special is to build the best industrial sewing machines in the world. Our new line of Upper Rotary Shaft Edgeloek Machines, known as the "Forty-Three Thousand Series" marks an epoch in sewing machine design and construction.

All parts are made to gauges with exceedingly close limits. Oil cups are provided for all important bearings, and a convenient oil drain catches the surplus. Repairs can be made with facility as all parts are readily accessible, and are 100% interchangeable.

It is our constant aim to furnish carefully prepared information that will enable the customer to secure all possible economies and advantages from the use of UNION SPECIAL machines. On the pages which follow will be found illustrations and definitions of the parts for styles in Classes 43200 and 43800.

In all manufacturing centers will be found Union Special representatives, who will co-operate with those who desire in planning and estimating their requirements.

UNION SPECIAL CORPORATION
Engineering Department

IDENTIFICATION OF MACHINES

Each UNION SPECIAL machine carries a style number which is stamped in the name plate on the machine. Style numbers are classified as standard and special. Those which are standard have one or more letters suffixed, but never contain the letter "Z". Example: 43200 F. Style numbers which contain the letter "Z" are special. When only minor changes are made in a standard machine a "Z" is merely suffixed to the respective standard style number. Example: 43200 FZ.

Styles of machines similar in construction are grouped under a class number which differs from the style number in that it contains no letters. Example: 43200.

APPLICATION OF CATALOG

This catalog applies only to the standard styles of machines are listed herein. It can also be applied with discretion to the special machines in the "Forty-Three Thousand Series".

STYLES OF MACHINES in CLASS 43200

Flat Bed Single Needle Edgeloek Machines

- 43200 A For binding aprons, dresses, and similar garments, seam Type BSc-1, Type 106 GS needle, uses cut edge strip, standard widths $3/4$, $7/8$, 1, $1\ 1/8$ and $1\ 1/4$ inches.
- 43200 B For seaming mattress ticks, bound seam Type BSa-1, Type 108 GHS needle, uses selvage edge strip, standard widths $5/8$, $3/4$ and $7/8$ inch.
- 43200 C For seaming mattress ticks, plain seam, Type 108 GHS needle.
- 43200 D For seaming canton flannel and jersey cloth gloves, also leather palm gloves, seam Type SSa-1, Type 106 GS needle.
- 43200 E For hemming highback overall suspenders; stitching Type EFb-1 inverted, Type 108 GHS needle, standard width of hem $5/16$ inch.
- 43200 F For seaming trousers, coats, and similar garments, Type 108 GHS needle.

STYLES OF MACHINES IN CLASS 43800

Flat Bed Multiple Needle Edgeloek Machines

43800 A Forhemming patch pockets of overalls and similar garments, stitching spec. 401-EFb-2 inverted, two needles, two loopers, left needle in front, 5/32 inch space between needles in line with feed, Type 108 GHS needles, standard gauge No. 12.

NEEDLES

TYPE NUMBERS AND SIZES

Each needle has a type number and size number. The former denotes the kind of shank, point, length, groove, finish, and other details. The latter denotes the largest diameter of the blade, measured in thousandths of an inch midway between the shank and eye, and is stamped in the needle shank. Collectively, the type number and size number is the complete symbol.

To have orders promptly and accurately filled, the empty package, a sample needle, or the type and size number should be given. Use description on label. A complete order would read: '100 Needles Type 106 GS, Size 090/036. The type numbers of the needles most commonly used in the styles of machines covered by this catalog are listed below. Set opposite each type number is the definition of the needle.

<u>Type No.</u>	<u>Description</u>
106 GS	Round shank, round point, extra short, double groove, struck groove, ball eye, chromium plated - size 090/036.
108 GHS	Round shank, round point, extra short, double groove, struck groove, ball eye, ball point, spotted, chromium plated - sizes 080/032, 090/036, 100/040, 110/044, 125/049.

APPLICATION OF TYPE NUMBERS TO MACHINES

The type of needle applicable to each style is listed in the description of each style.

ORDERING REPAIR PARTS

PLATES

Grouped, according to scale, will be found illustrations of parts similar in appearance, and, to some extent, component parts that go in the same subdivision of the mechanism.

When a given design of part is made in two or more sizes, only one illustration is usually shown. In ordering these pieces it is necessary that the additional information be furnished as requested under these illustrations.

ORDERING REPAIR PARTS (cont'd)

LIST OF PARTS

Turning from the plate to the list of parts, the description of each part and its principal uses will be found. Always check the symbol against its description before ordering. It is not necessary to furnish the plate number.

When a part is used, or can be used, in all machines covered by this catalog, no specific use is mentioned in the definition.

For convenience in ordering, minor parts such as screws, nuts and similar articles are repeated after each major part.

(-) A dash in the "plate number" column of the list of parts indicates the absence of an illustration.

(‡) A double dagger in the "symbol to order by" column indicates that component parts cannot be furnished separately.

IDENTIFYING PARTS

Where construction permits, each part is stamped with its part number. Some of the smaller parts are stamped with an identification letter to distinguish them from parts similar in appearance.

All part numbers represent the same part, regardless of the catalog in which they appear.

SUPPLIES

All supplies, including taps, reamers, belting, belt hooks, belt fasteners, screwdrivers, wrenches and powdered oil stone will be promptly furnished.

USE GENUINE REPAIR PARTS

Success in the operation of these machines can be secured only with genuine UNION SPECIAL repair parts as furnished by the Union Special Corporation, its subsidiaries and authorized distributors. They are designed according to the most approved scientific principles, and are made with utmost precision. Maximum efficiency and durability are assured.

TERMS

Prices are net cash and subject to change without notice. All shipments are forwarded f.o.b. shipping point. Parcel Post shipments are insured unless otherwise directed. A charge is made to cover postage and insurance.

Plate 1 - Full Size

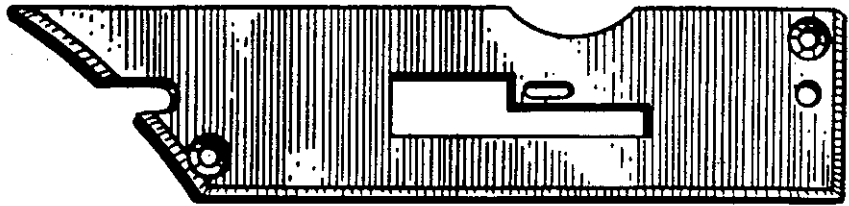

43224

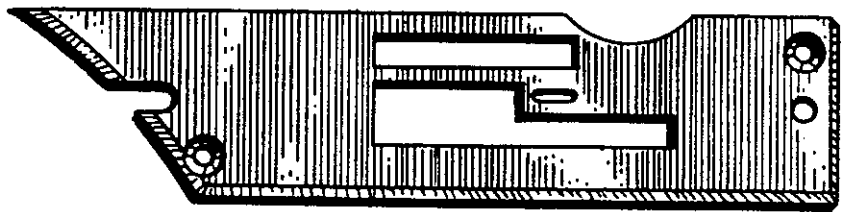

43224 C

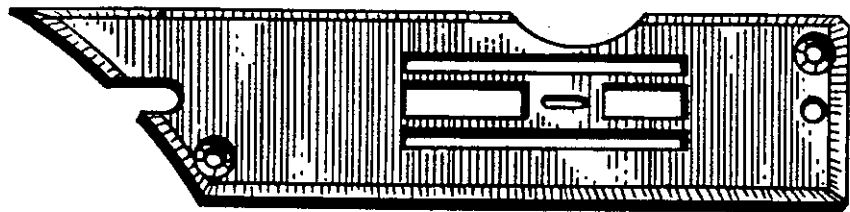

43224 F

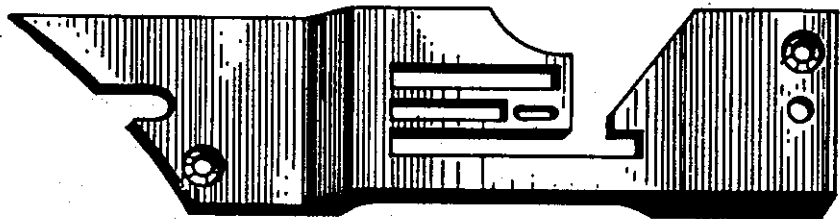

43228 A

Plate 2 - Full Size

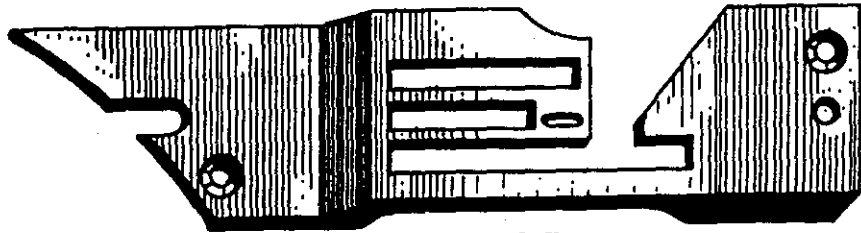

43228 B

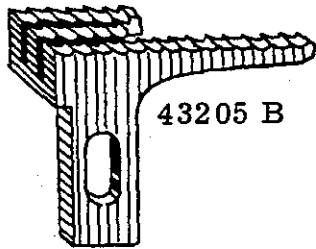

43205 B

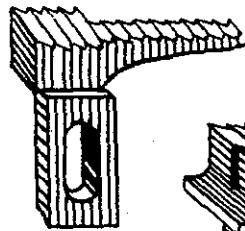

51205 W

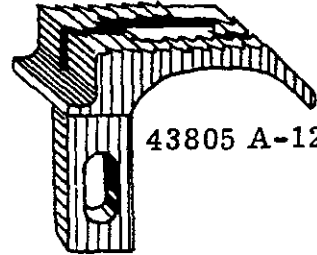

43805 A-12

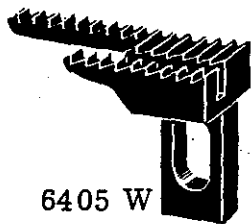

6405 W

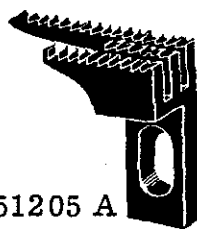

51205 A

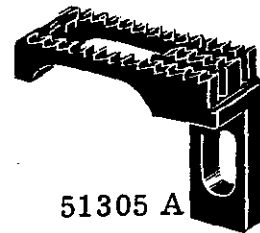

51305 A

Plate 3 - Full Size

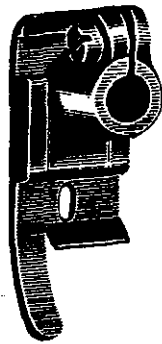

6420 W

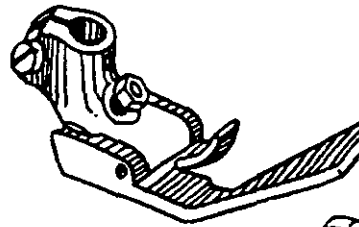

43220 A



1741 B

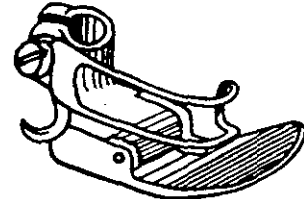

43220 D

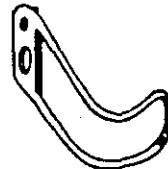

43230 B

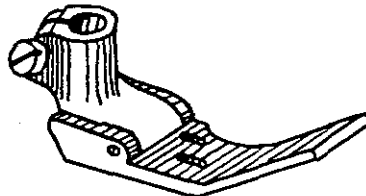

43820 A
Specify Gauge

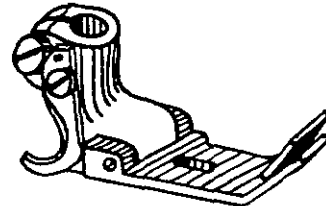

43220 E

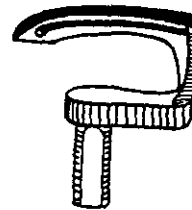

43808
Specify Gauge

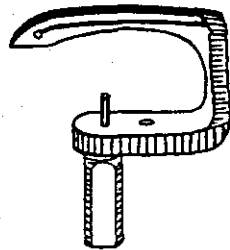

43208 D

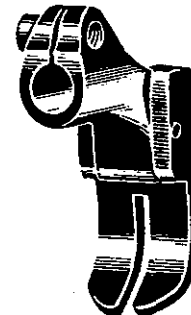

43220 F

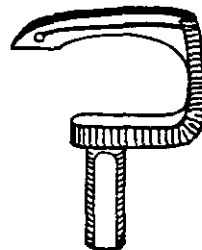

43809

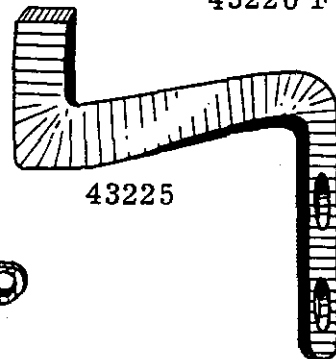

43225

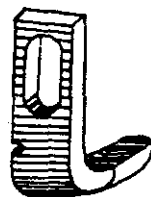

43425 B



43210 D

Plate 4 - Full Size

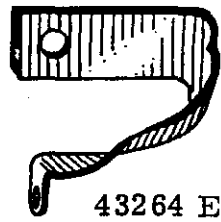

43264 E

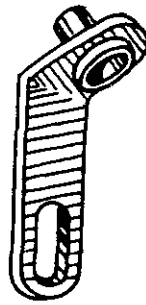

43864 G



43864 N

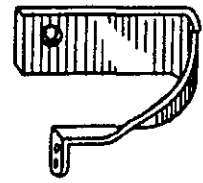

43864 E



43264 R



43281 K



109

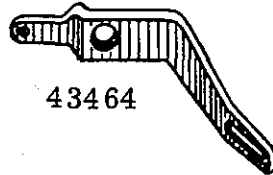

43464



668-9

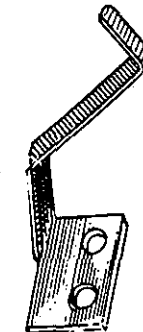

43232



57 WB



57 WD



43264

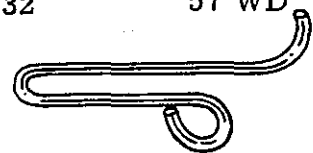

43268

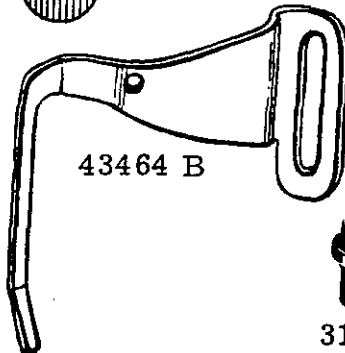

43464 B

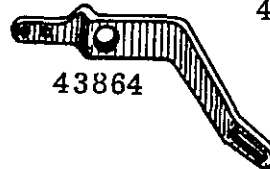

43864



31562



43297 A



43264 V

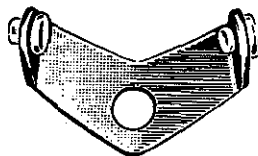

51292 D



51292 A



51292 C

Plate 6 - Full Size



22588 A



22516



93



42 A



22894W



22596

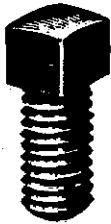

69 FD



12934A



22508



22587 E



22872



22571 A



525

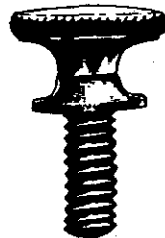

25



22707



22582



22791 B



22806 A



650 G-10



43242 J



22843



22764A

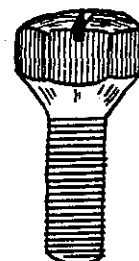

22823 A

Plate 5 - Full Size

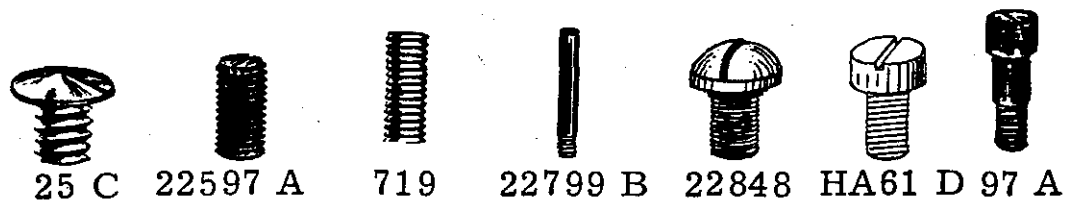
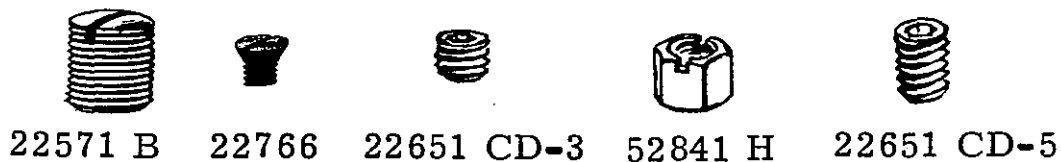
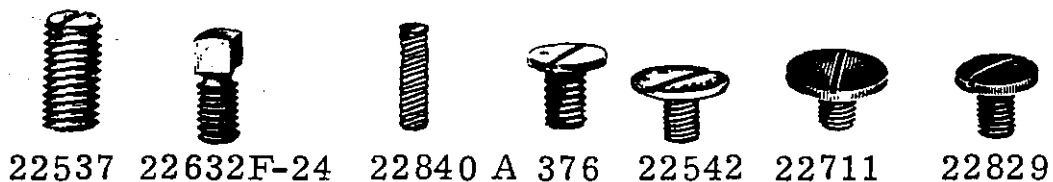
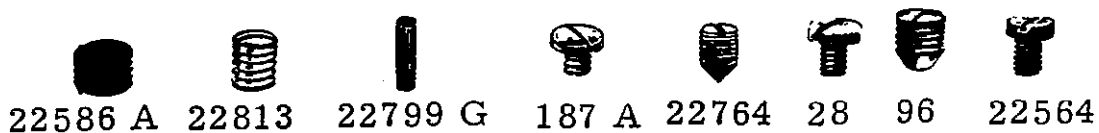

Plate 8 - Full Size

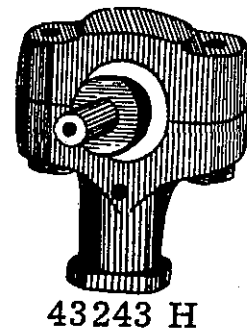
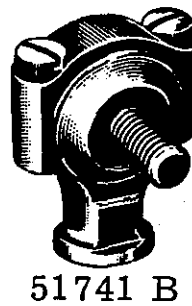
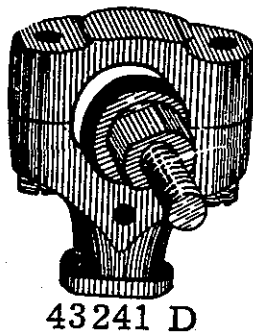
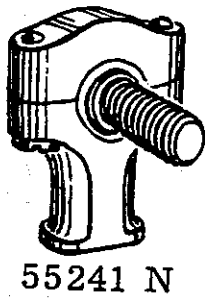
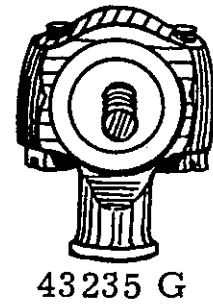
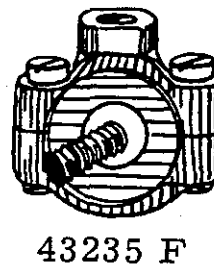
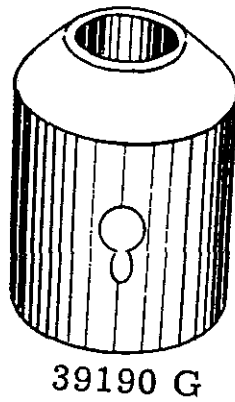
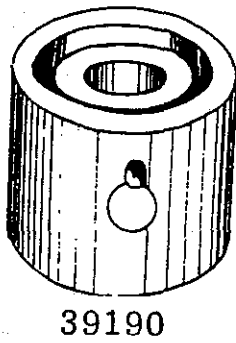
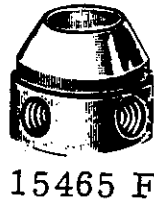
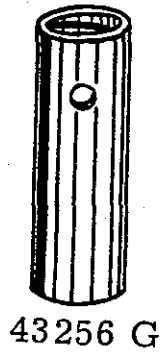
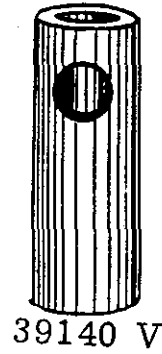
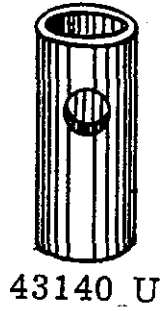
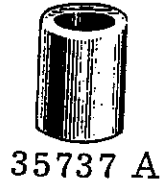
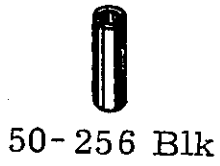
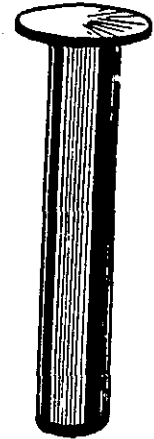
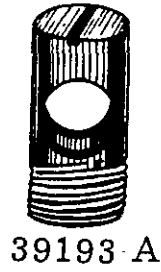

Plate 7 - Full Size

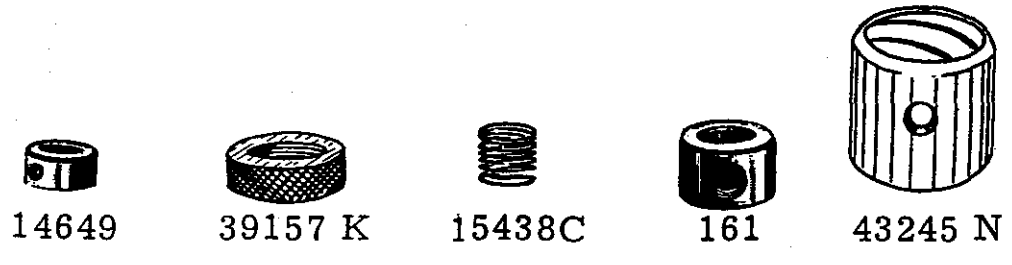
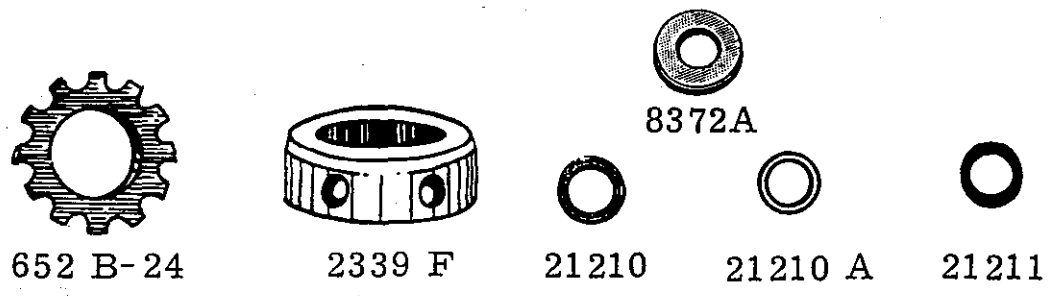
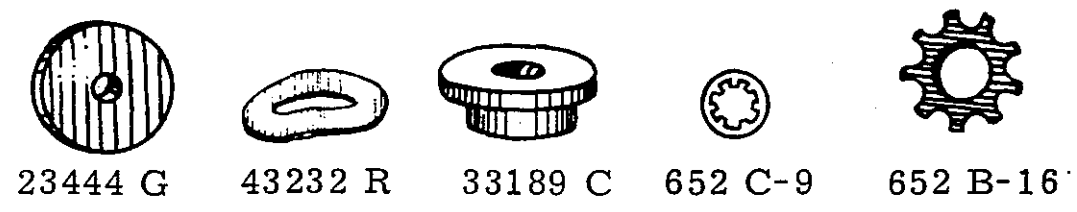
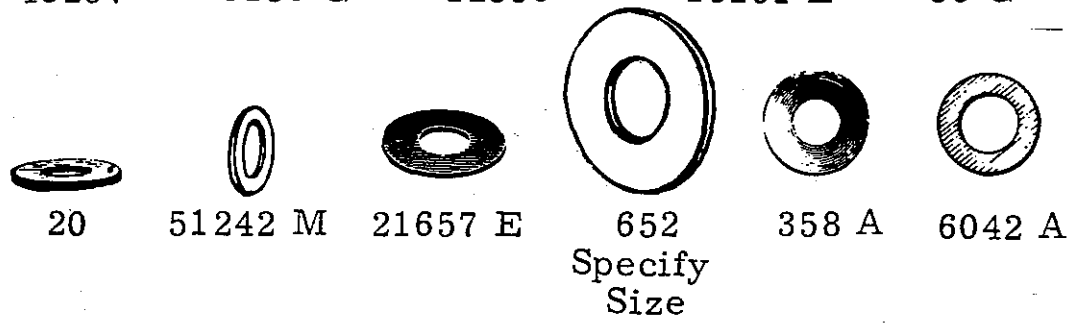
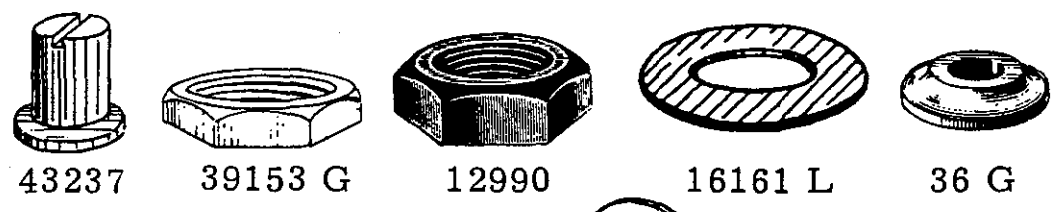
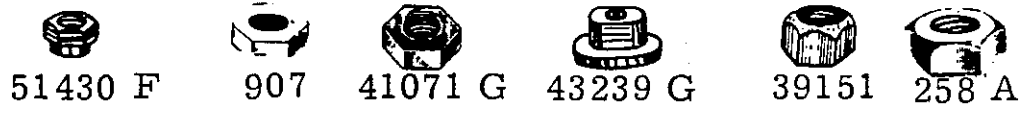

Plate 9 - Full Size



43297



51292 F-5



51292 F-1



39157



14775 A



16241

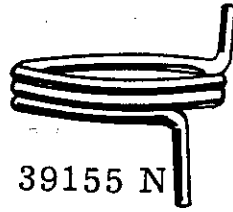

39155 N



666-31



666-53



21351

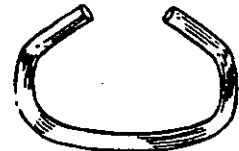

21351 A



21351 B

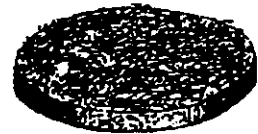

660-127



666-11

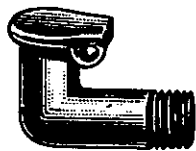

666-1

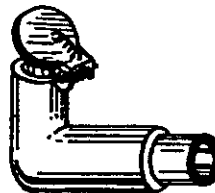

666-24



666-90



21225

Specify Measurement

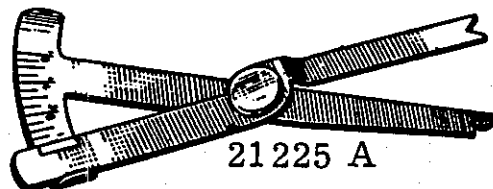

21225 A

Plate 10 - Full Size



39252 N

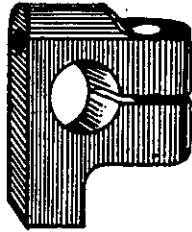

43455

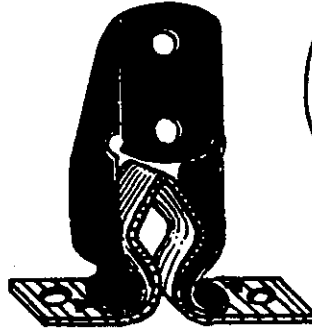

660-112

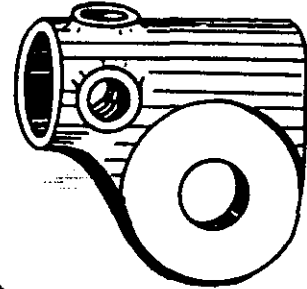

43245



43241 A

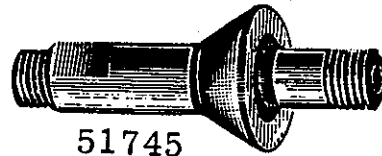

51745



41047



57885 A

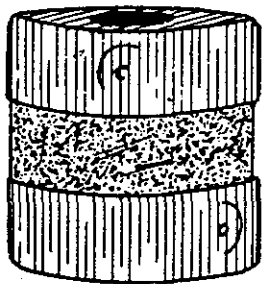

51295 A



52841G

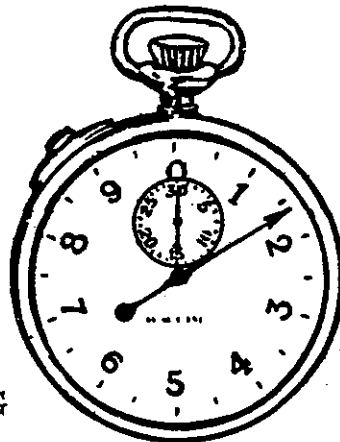

WA15 A



660-240



39243 H



666-37



51240 D

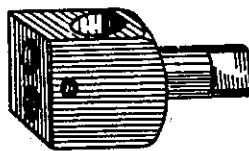

39152



39157 J



39144 V

Plate 11- One-half Size

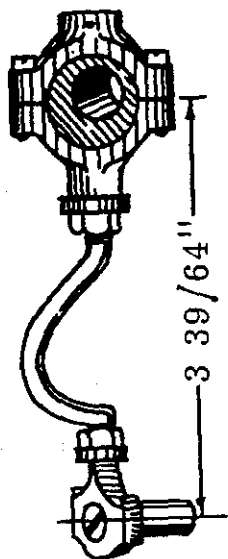

29477 EB

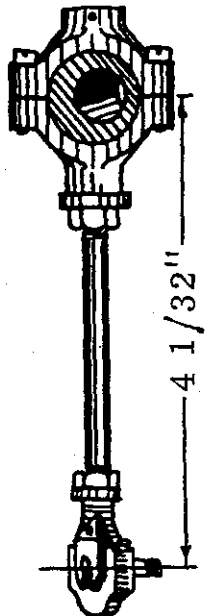

29477 EC

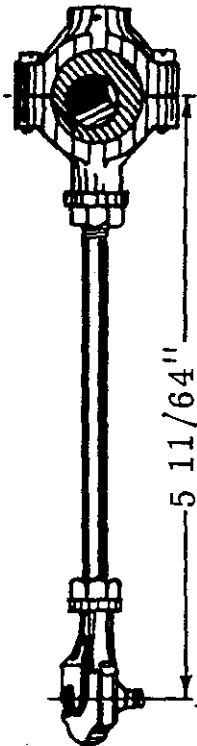

29477 ED

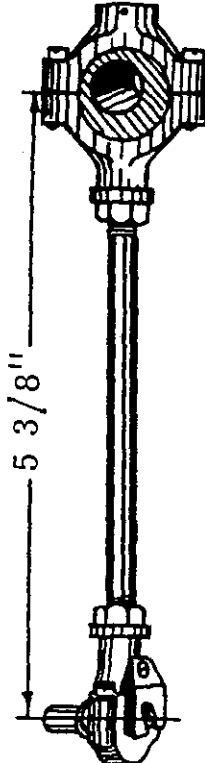

29477 EE

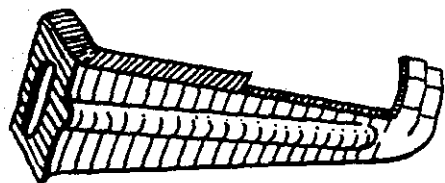

43825

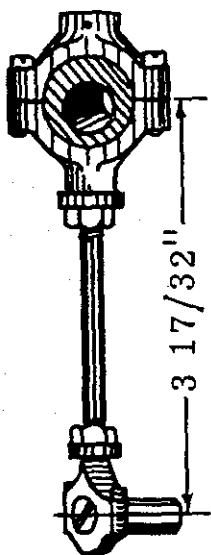

29477 FB

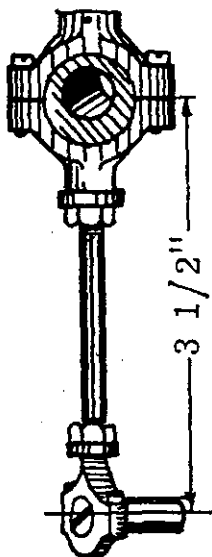

29477 FC

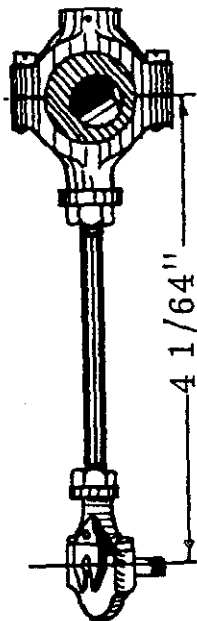

29477 FD

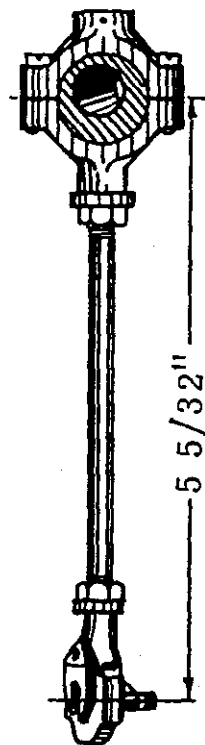

29477 FE

Plate 12- One-half Size

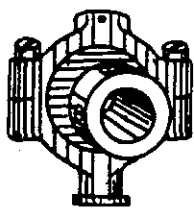

29126 D

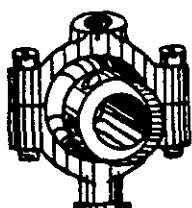

29126 K

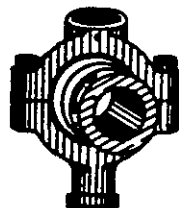

29126 N

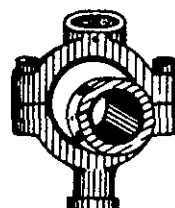

29126 P

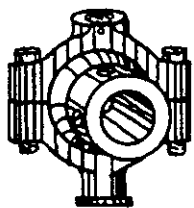

29126 S

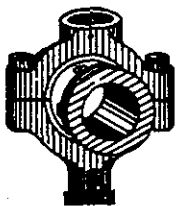

29126 V

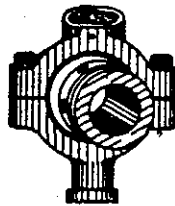

29126 W

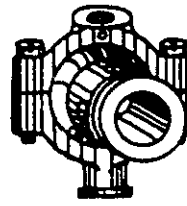

29126 AJ

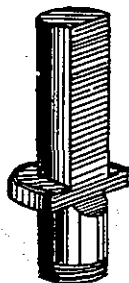

39253

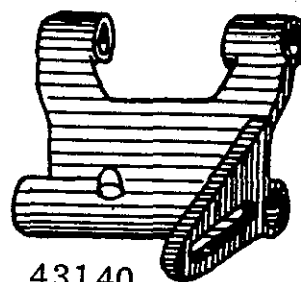

43140



51292

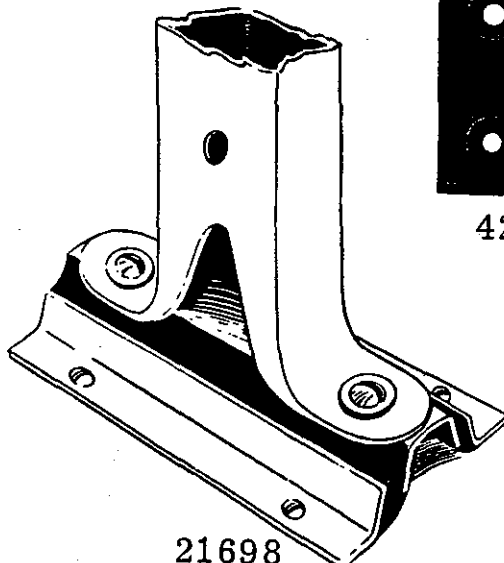

21698
Specify Length



423



39152 U
Specify
Minor
Symbol

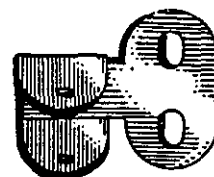

43281 J

Plate 13- One-half Size

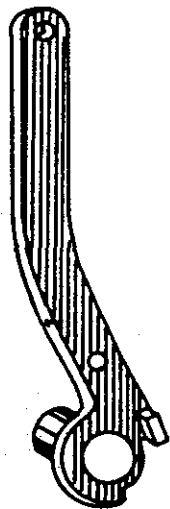

43255 A



39195



666-61



666-51

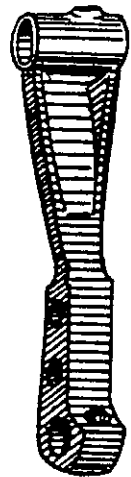

43234

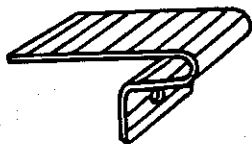

21387 G



43203 D



43255 B



51292 G



668-27



21114 M

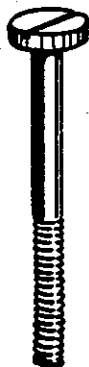

22871



24 X

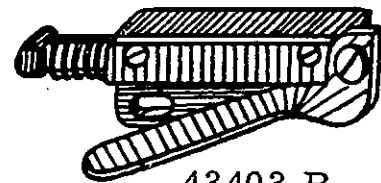

43403 B



43294 C



43294 D



21355



39195 A

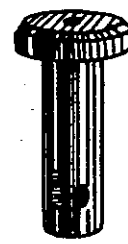

21398 AG

Plate 14- One-half Size

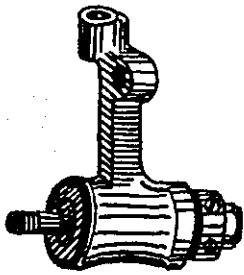

29192

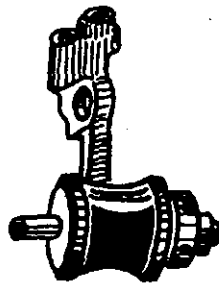

29192 A

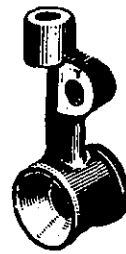

51213



51413

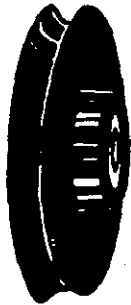

21398 T

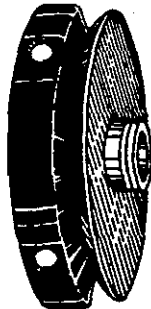

39121

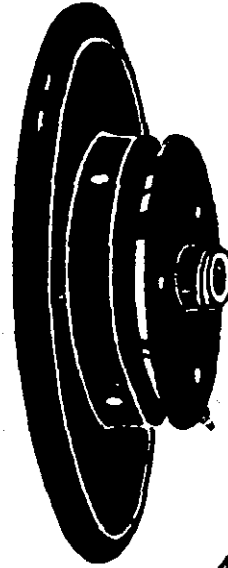

43221 G



39195 B



23444 N

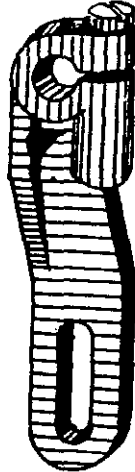

43245H



43239



43242

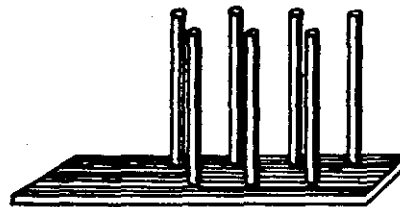

23439 A



9271

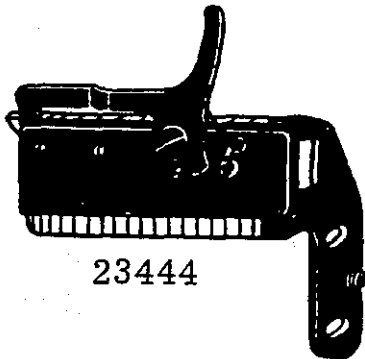

23444



23444 A

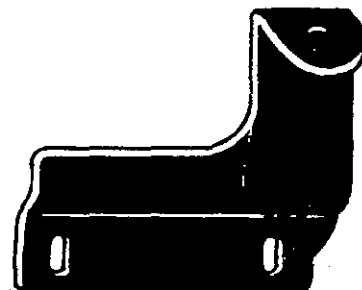

23444 F

Plate 15- One-half Size

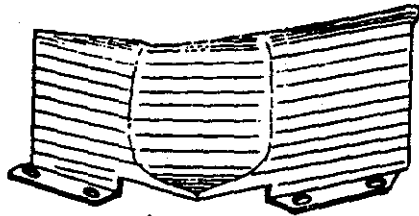

43278

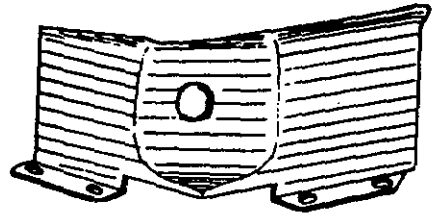

43278 A

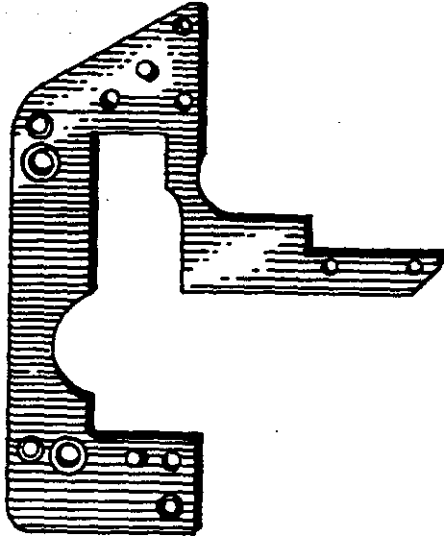

43280 A

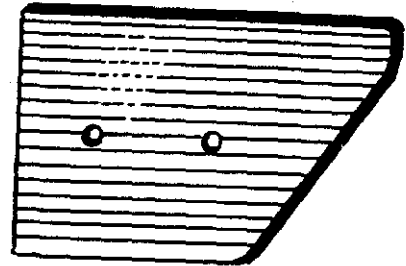

43279 A

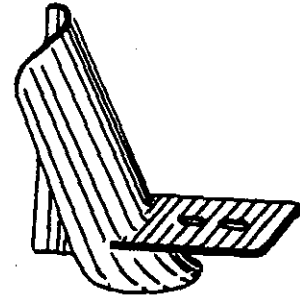

43278 C

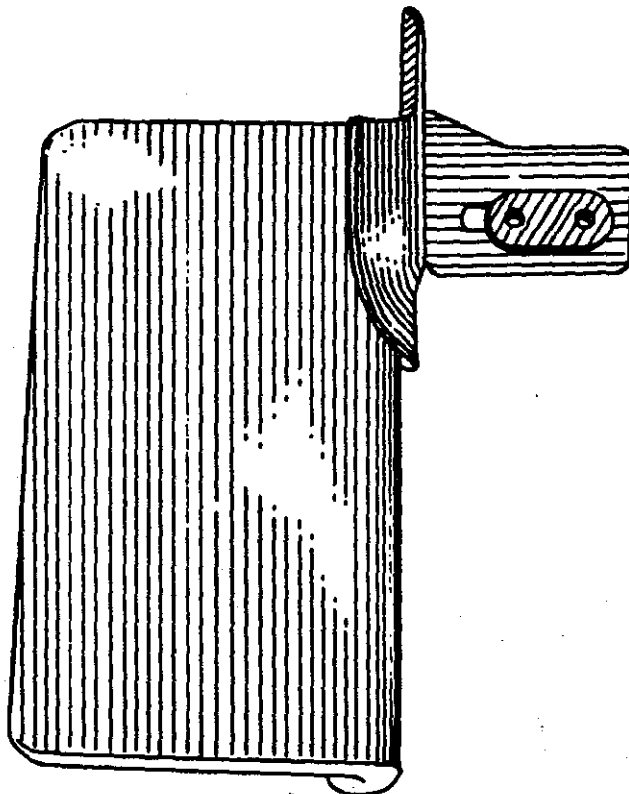

23410 A-3/8

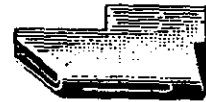

23215 BC
Specify Width of
Binding Strip



23322 AB
Specify Width of
Binding Strip

Plate 16- One-half Size

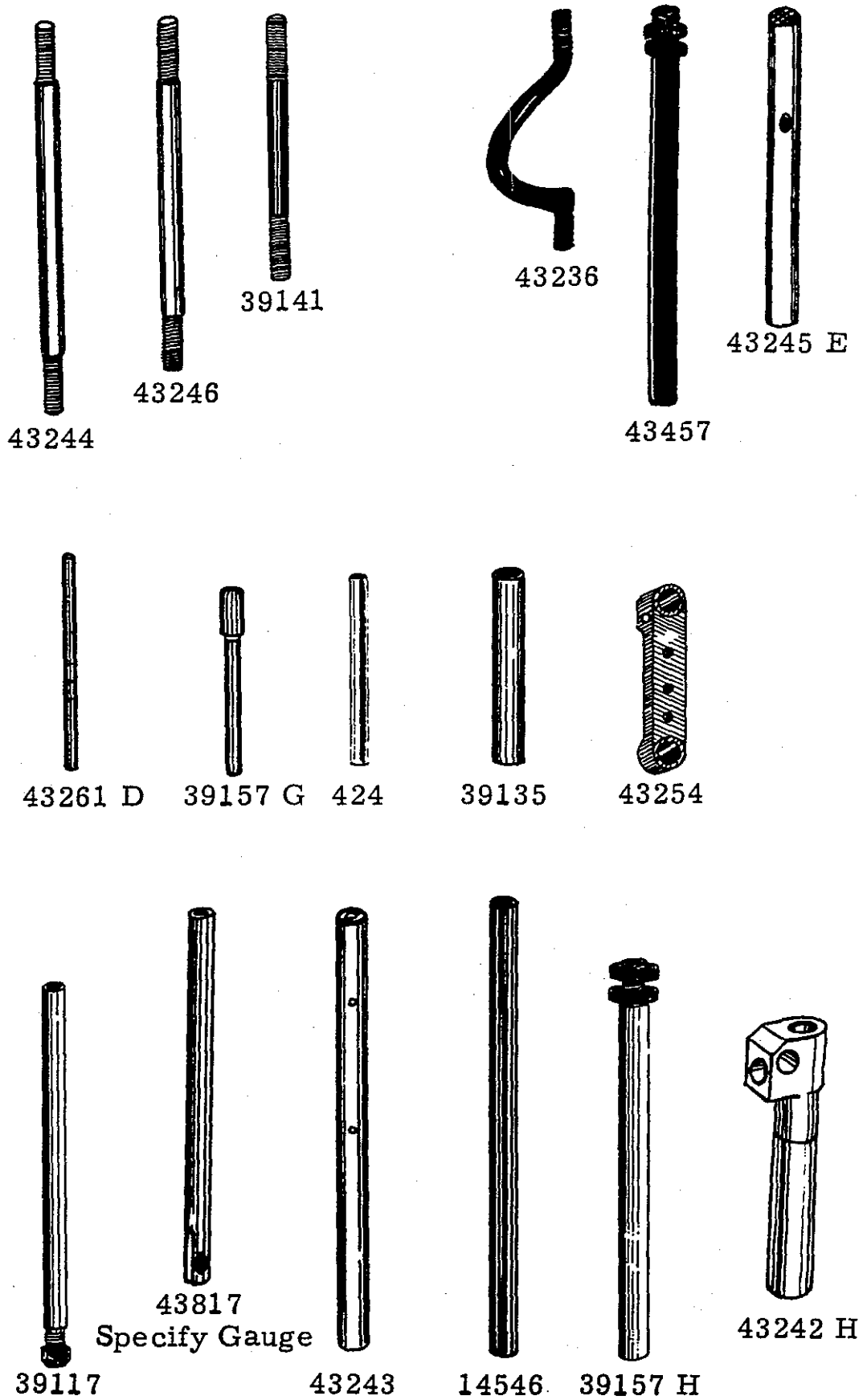
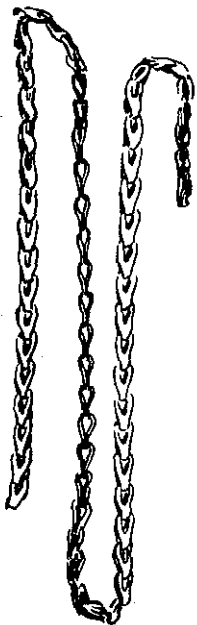

Plate 17- One-half Size



421 D
Specify Length



21388



660-264

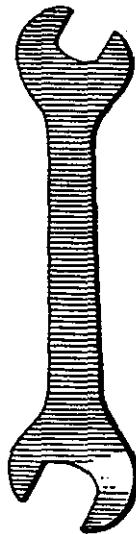

21388 R



21388 N



28505



116



21369 C

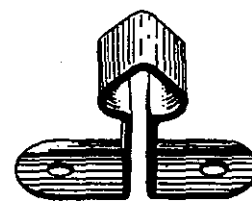

21369 D

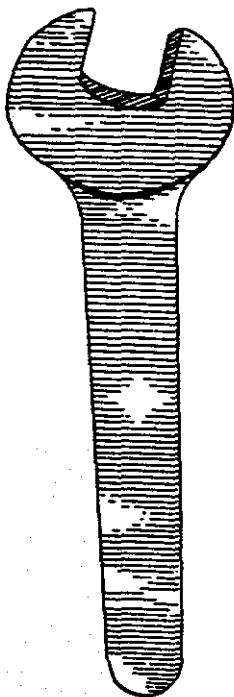

21388 U

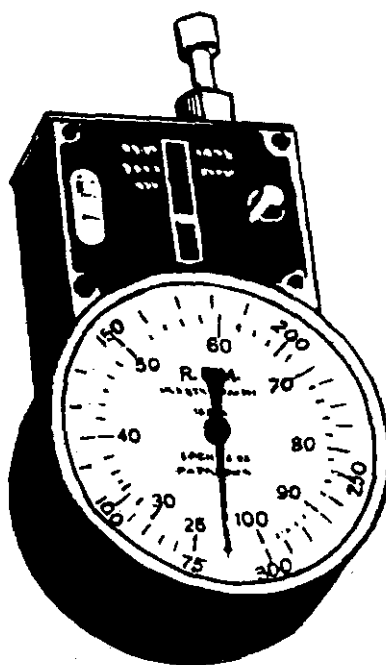

TA55



21207

Plate 18- One-fourth Size

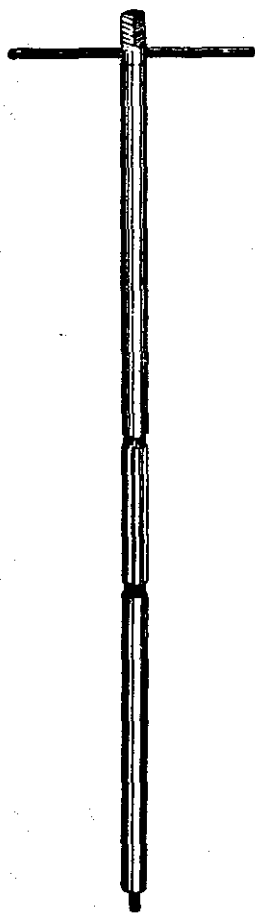

Y676

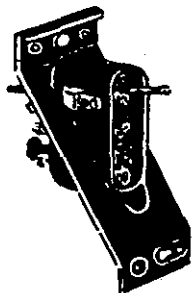

39262 E



21679



21661

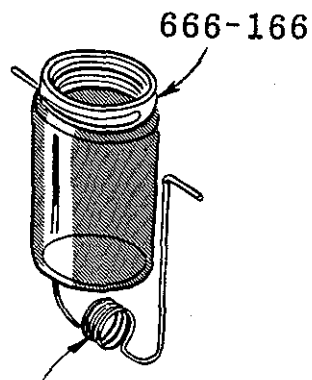

666-166

21393 P

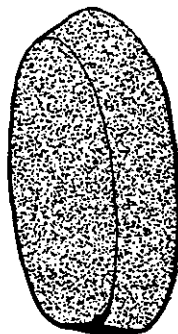

660-168



21665



43294 A

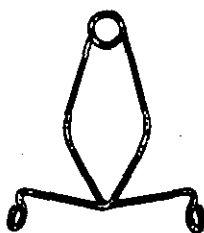

51294A

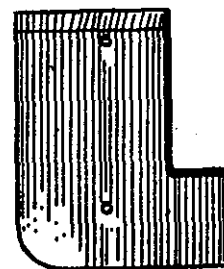

43279 B

Plate 19 - One-fourth Size

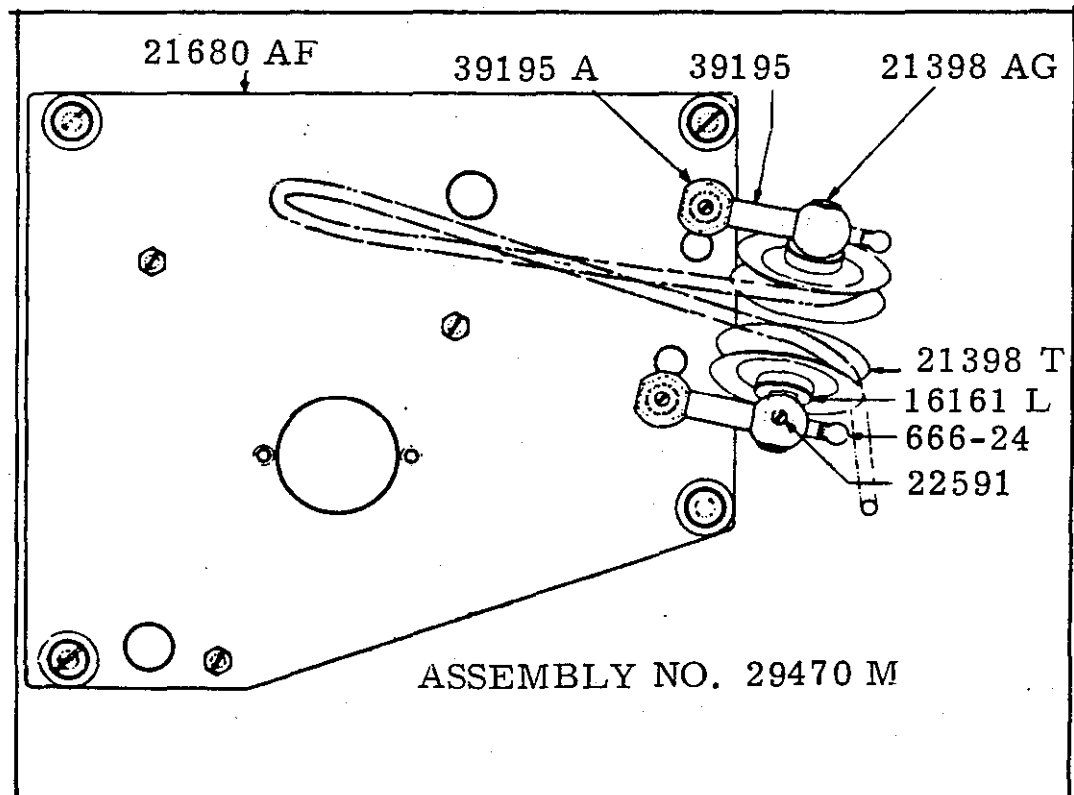
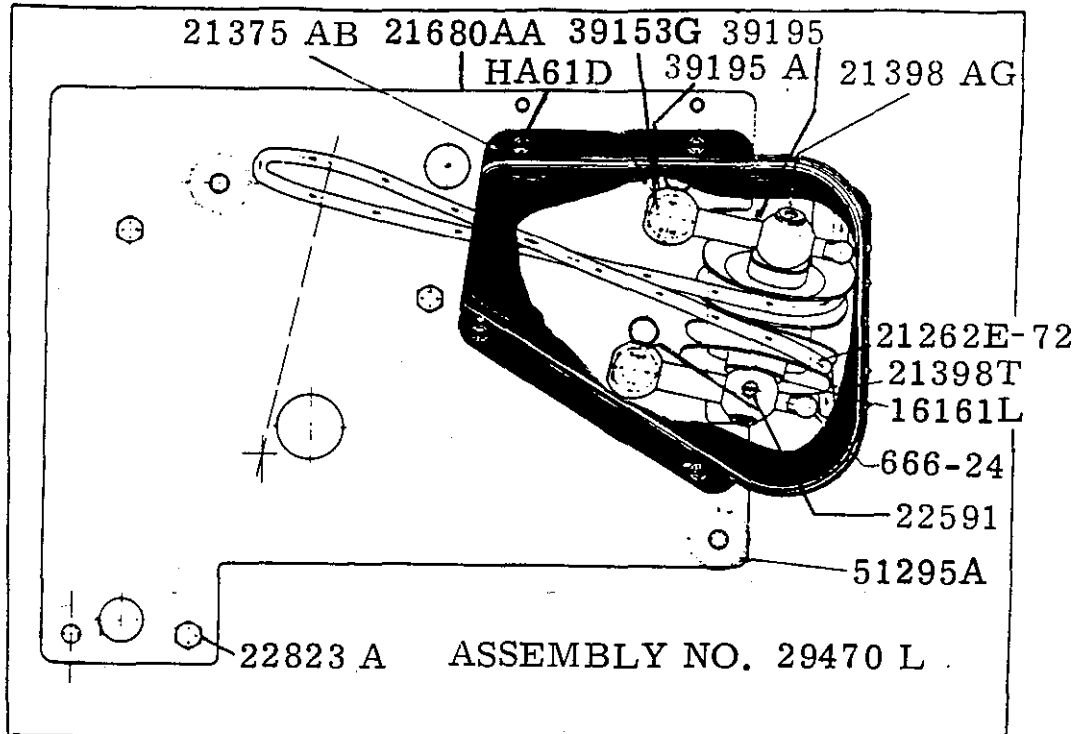

Plate 20 - One-fourth Size

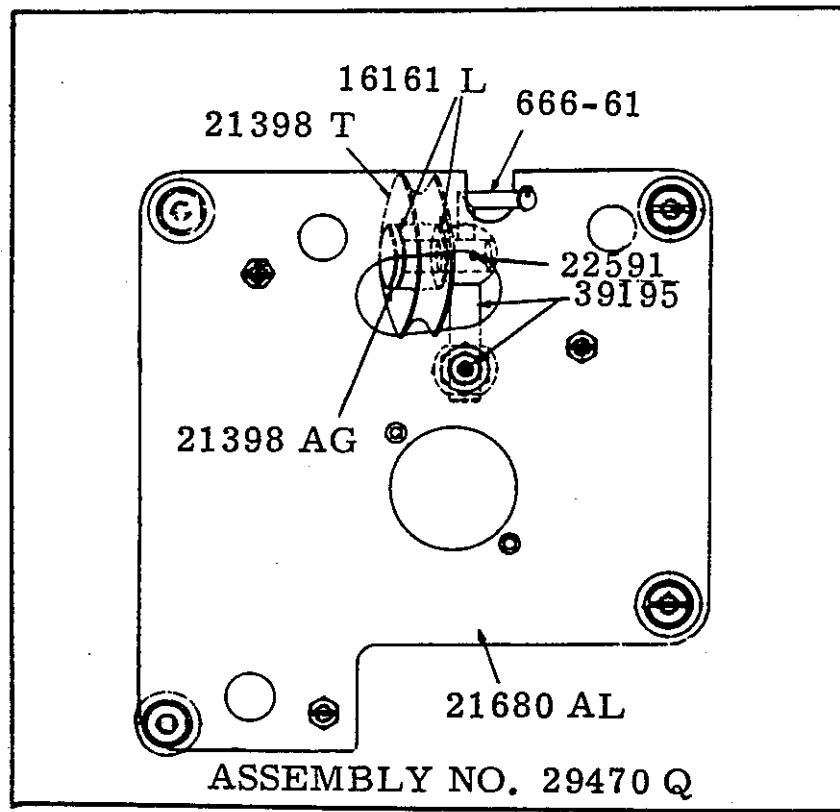
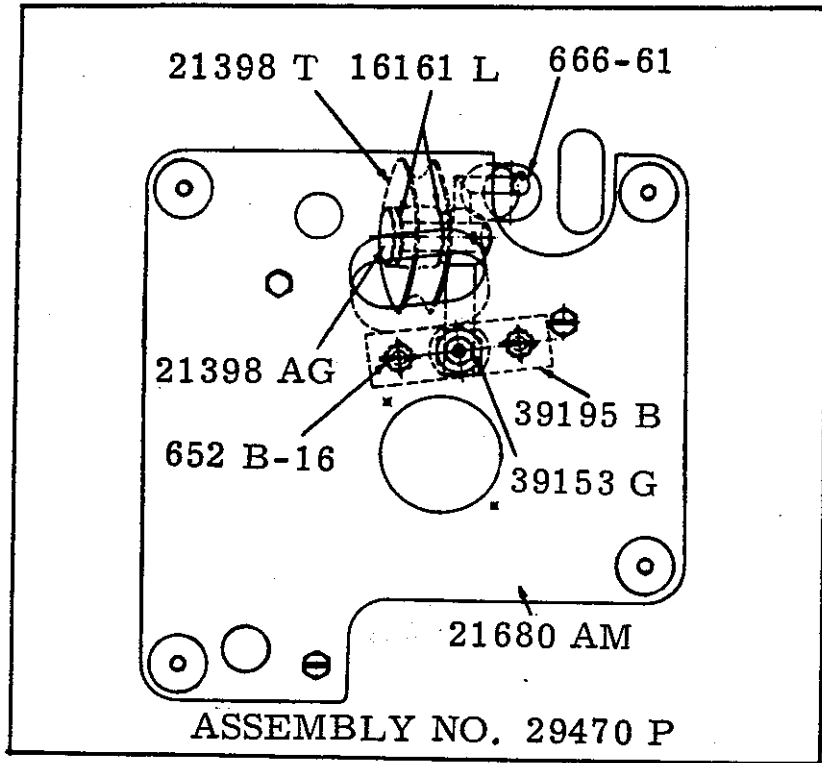
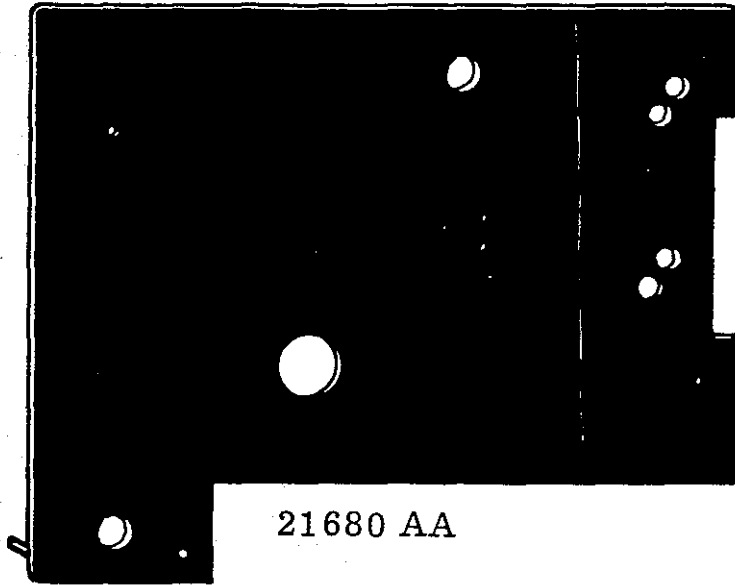
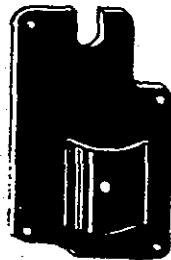

Plate 21 - One-fourth Size



21680 AA



43262



43261

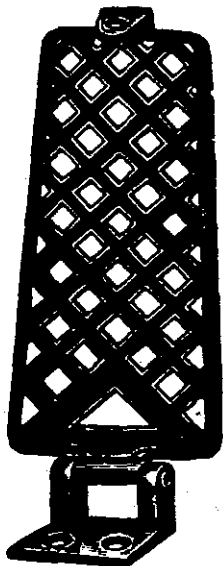

29402

Plate 22 - One Fourth Size

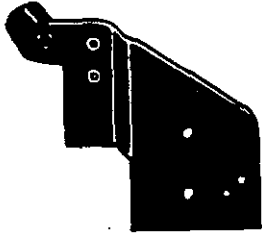

43281 M

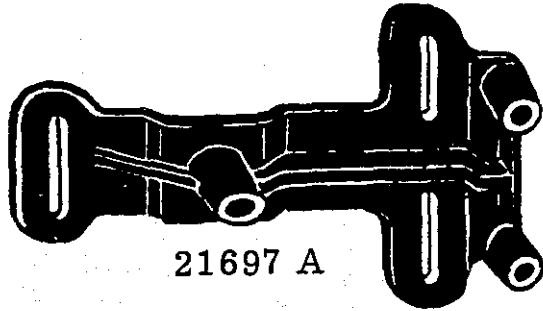

21697 A

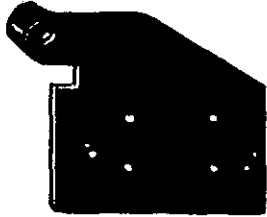

43281 H

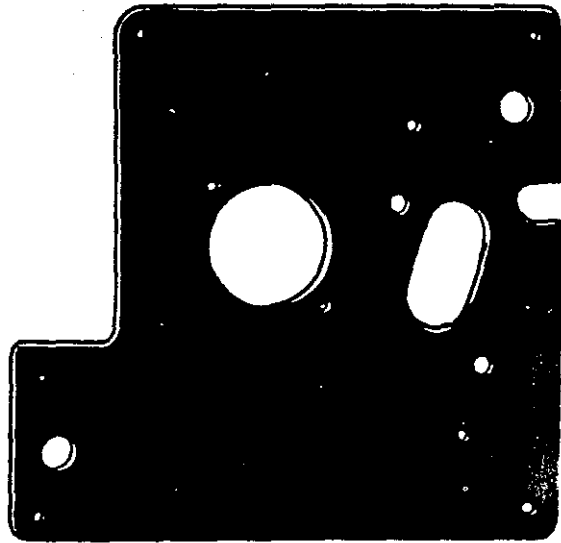

21680 AL

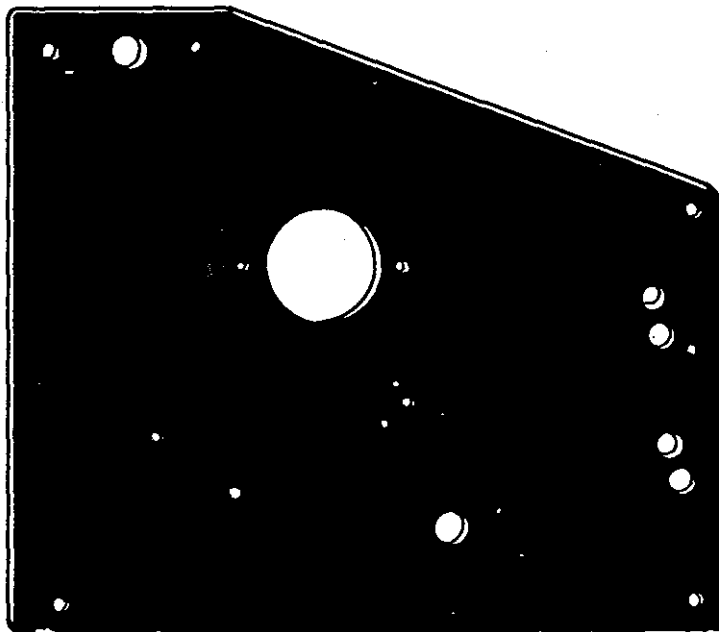

21680 AF

Plate 23 - One Fourth Size

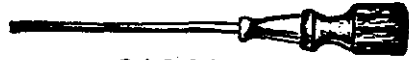

21201

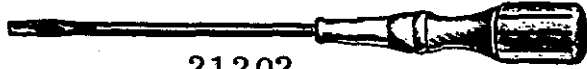

21202



21203



21204



21205 A

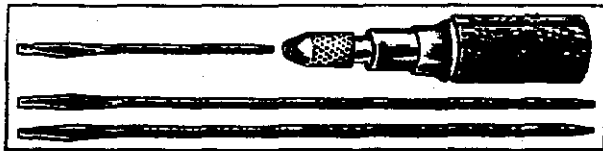

21208



100 B

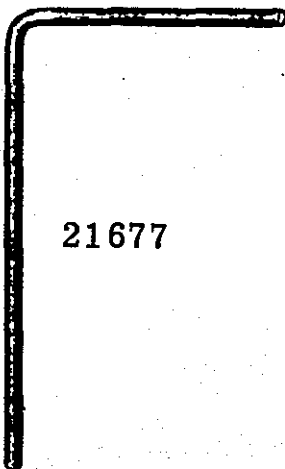

21677

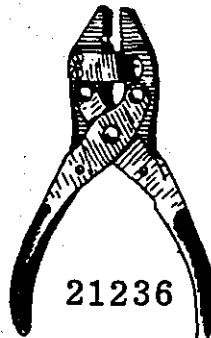

21236



43222 F



43222

Plate 24 - One Fourth Size



21104 B

Specify Length

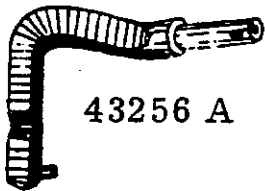
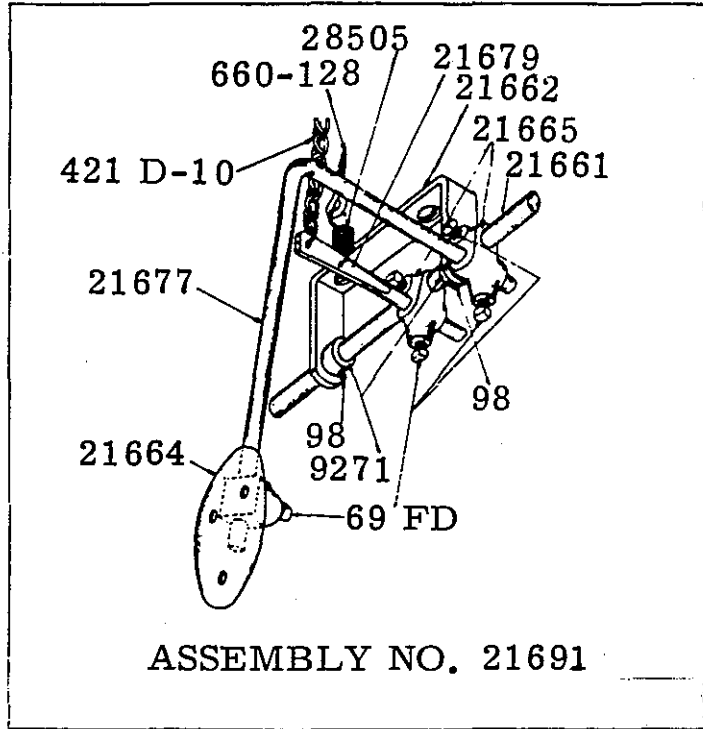

21664



21662

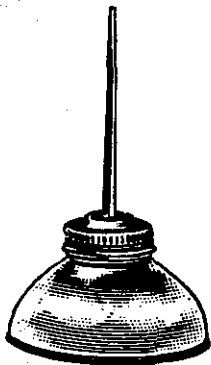

413

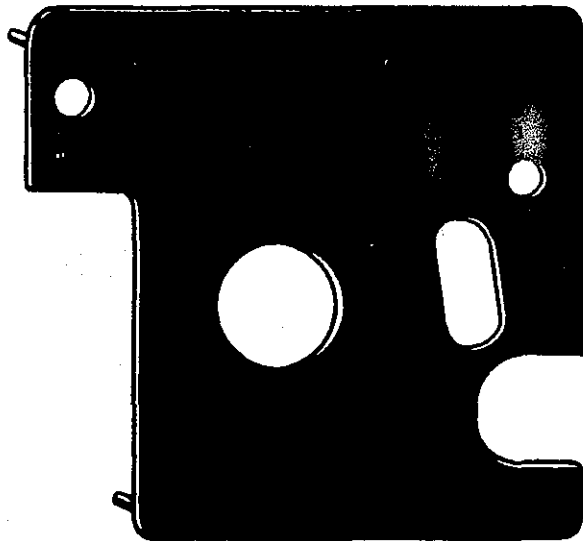

21680 AM

Plate 25 - One Eight Size

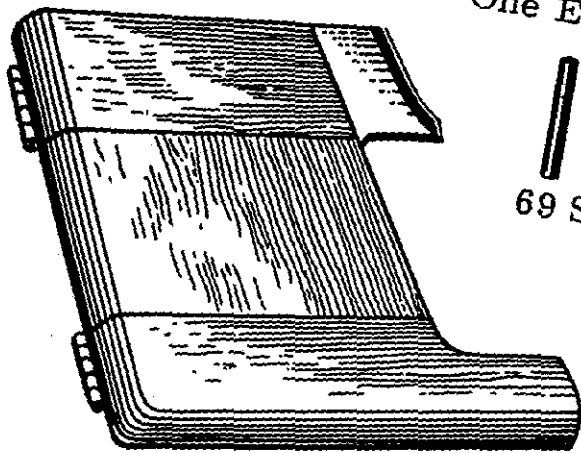

69 S

21376 K

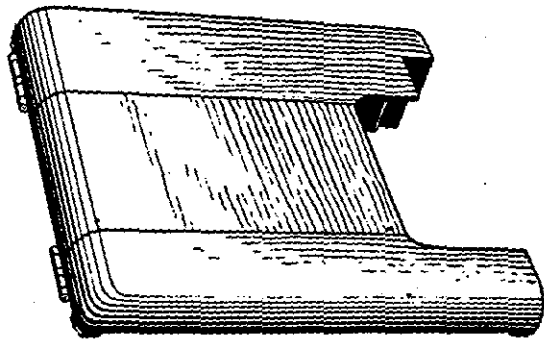

21376 H



43262 J

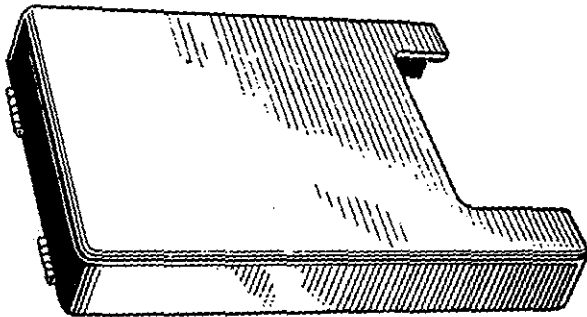

21376 G



39162 C



21375 AB

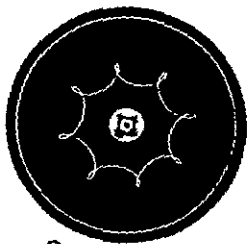

21169 E



21169 F

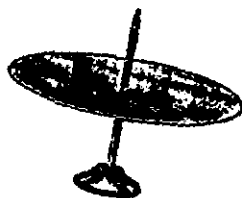

21169 D



43201

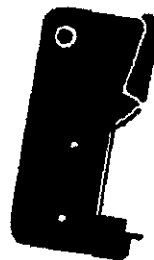

43201 B

Plate 26 - One Fourth Size

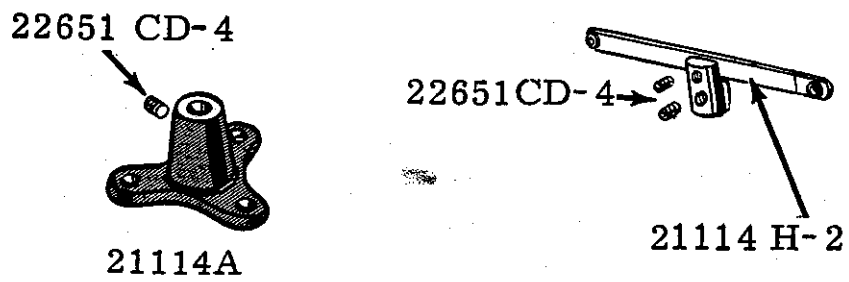
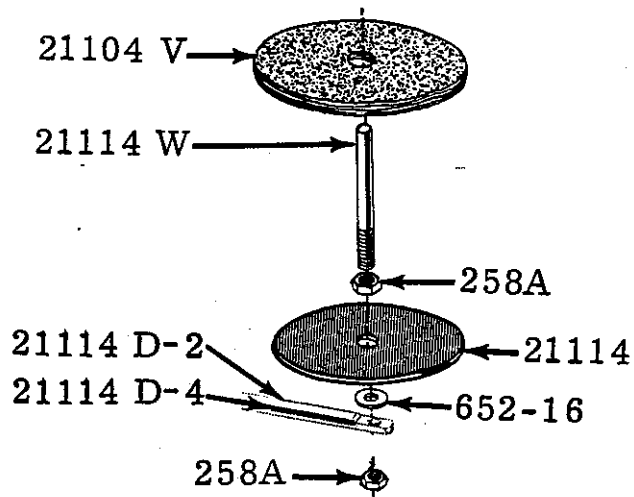
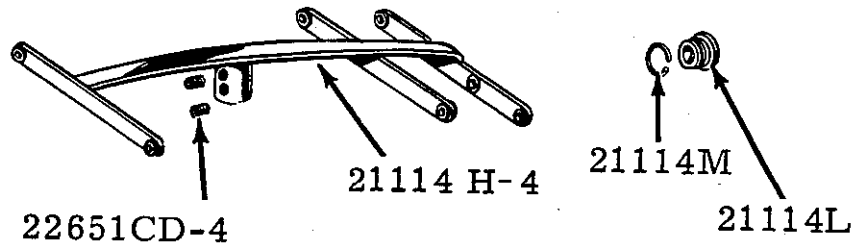
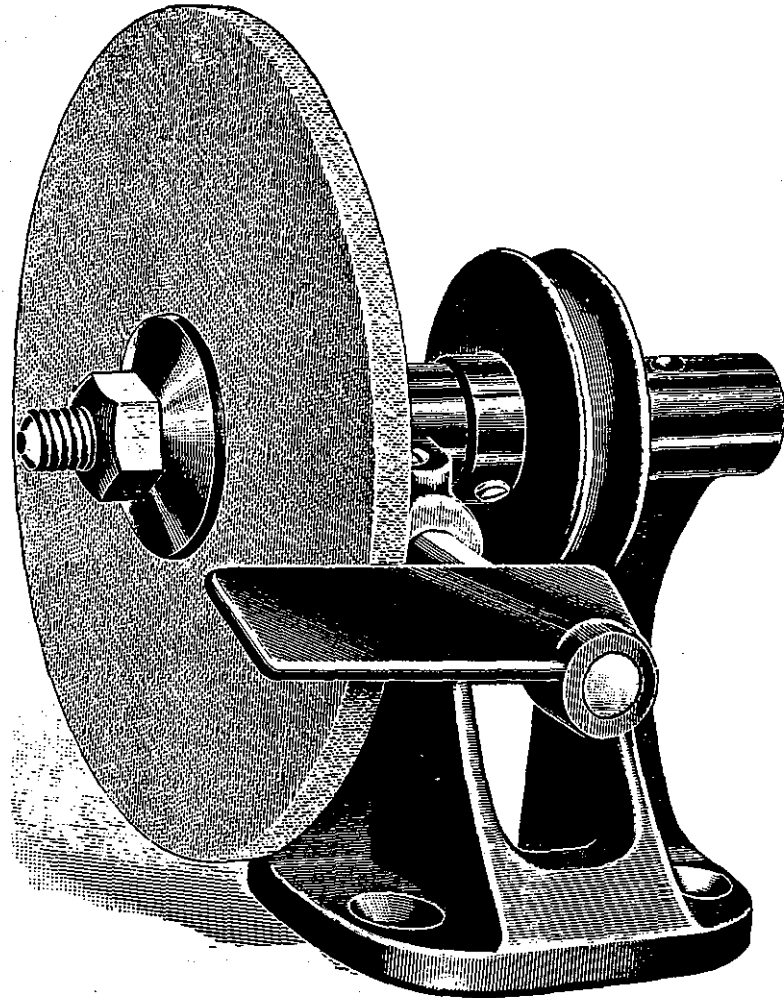

Plate 27 - One Half Size



21394 K
Utility Grinder

LIST OF PARTS

Symbol to Order By	The figures in the last column refer only to the plates illustrating the parts and are not to be used in ordering. Prices furnished on application.	Plate No.
WA15 A	Stop Watch -----	10
18	Connecting Rod Nut, right thread, for Nos. 39141, 41047, 43236, 43244, 43246, 51240 D, 51741 B, 55241 N -----	7
20	Needle Guard Washer, for Style 43200 F-----	7
24 X	Edge Guide, for Styles 43200 C, 43200 F(screw No. 25 or 25 U) -----	13
HS24 C	Screw, fillister head, for swinging plate spring---	5
25	Thumbscrew, with detachable washer, for edge guide No. 24 X on Style 43200 C, for No. 43203 D on Style 43200 D -----	6
25 C	Screw, fillister head, for attachment, No. 23410 A-3/8, K48195; also for No. 43279 A -----	5
28	Screw, for throat plate -----	5
36 G	Needle Guard Washer, for Styles 43200 B, 43200 C, 43200 D, 43200 E, 43800 A; also for No. 51741 B	7
42 A	Cloth Plate Latch Pin and Lifter Lever Stop Pin; also for No. 43455 -----	6
50-256 Blk.	Oil Tube, 7/16 inch long, for needle bar link-----	8
TA55	Hand Tachometer, four speed type, 90 to 1200 R. P. M. -----	17
57 WB	Nipper Spring Plate, for Style 43200 F -----	4
57 WD	Screw, for No. 57 WB on Style 43200 F-----	4
HA61 D	Attaching Screw, for belt guard on assembly No. 29470 L -----	5
69 S	Spool Pin, 4 inches long, for old style thread stand -----	25
69 FD	Set Screw, square head, cup point, 5/16 inch dia., 18 threads to the inch, 5/8 inch long for Nos. 21664, 21665, 21677, 21679 -----	6
73	Set Screw, for looper-----	5
73 A	Screw, for looper needle guard; also for No. 43264 R -----	5
87	Screw, for pin tension on Styles 43200 A, 43200 B	5
87 A	Screw, for throw-out edge guide slide plate on glove closing machines -----	5
87 U	Screw, for needle thread eyelet on needle bar link; also for No. 43264 E -----	5
88	Screw, for adjustable frame looper thread eyelet; also for Nos. 161, 14649, 29126 D, 29126 K, 29126 N, 29126 P, 29126 S, 29126 V, 29126 W, 29126 AJ, 39117, 39152, 43264 V, 43817-12, 43864 N -----	5
89	Set Screw, for feed bar shaft; also for No. 43818-12	5
90	Screw, for fabric guard on Style 43200 F; also for No. 23215 BC, 23322 AB, 23444 A, 23444 N, 43278 C, 43279 B -----	5
91	Clamp Screw, for presser feet shank -----	5
91 A	Screw, 3/32 inch long, for presser foot chain knife on Styles 43200 E, 43200 F -----	5

LIST OF PARTS

Symbol to Order By	The figures in the last column refer only to the plates illustrating the parts and are not to be used in ordering. Prices furnished on application.	Plate No.
93	Screw, 7/16 inch long, for feed dog; also for No. 33189 C, 43455 -----	6
95	Stop Screw, for adjusting binder support sliding plate bracket on Styles 43200 A, 43200 B -----	5
96	Spot Screw, for looper rocker frame; also for Nos. 39121, 43221 G -----	5
97	Stop Screw, for maintaining height of feed dog --	5
97 A	Screw, for looper drive ball joint, also for 43241 D -----	5
98	Set Screw, for looper rocker frame; also for Nos. 2339 F, 9271, 39121, 43221 G -----	5
98 A	Screw, for frame looper thread guide -----	5
100 B	Thread Stand Wire, 16 inches long (screw No. 22632 F-24) for old style thread stand -----	23
109	Tension Disc -----	4
116	Wrench, 9/32 inch opening, for needle clamp nut	17
161	Binding Holder Disc Support Collar (screw No. 88)	7
187 A	Screw, for fabric guard on Styles 43200 A, 43200 B, 43200 C, 43200 D, 43200 E, 43800 A -	5
258 A	Looper Rocker Stud Nut; also for No. 21114 W --	7
269	Connecting Rod Nut, left thread, for No. 39141, 41047, 43236, 43244, 43246, 51240 D -----	7
358 A	Cloth Plate Supplement Plate Screw Washer, for Styles 43200 C, 43200 F -----	7
376	Screw, for throat plate support-----	5
413	Oil Can, with sprout -----	24
421 D-10	Chain, 10 inches long, for knee press assembly No. 21691 -----	17
421 D-34	Lifter Lever Chain, 34 inches long -----	17
423	Lifter Treadle Base, for No. 29402-----	12
424	Lifter Treadle Pin, for No. 29402 (screw No. 22813) -----	16
525	Thumbscrew, for swinging plate spring -----	6
531	Screw, for feed rocker shaft bushing; also for Nos. 14546, 43232 N -----	5
604	Screw, for needle bar cross head thread eyelet on Styles 43200 A, 43200 B, 43200 C, 43200 D, 43200 E, 43200 F-----	5
605	Screw, 5/32 inch long, for binder support sliding plate latch spring on Styles 43200 A, 43200 B; also for 1741 B, 43230 B -----	5
605 A	Screw, 3/16 inch long, for needle bar cross head thread eyelet on Styles 43800 A -----	5
650 G-10	Adapter Plate Attaching Bolt, for "Electro Drive" with either three or four point suspension; also for Nos. 29470 P, 29470 Q -----	6
652-16	Washer, for spool pin -----	7
652-20	Adapter Plate Attaching Bolt Washer, for "Electro Drive" with either three or four point suspension; also for Nos. 29470 P, 29470 Q ---	7
652 B-16	Shake-proof Lock Washer, 1/4 inch, external teeth, for stove bolt on idler assembly No. 29470 P -----	7

LIST OF PARTS

Symbol to Order By	The figures in the last column refer only to the plates illustrating the parts and are not to be used in ordering. Prices furnished on application.	Plate No.
652 B-24	Shake-proof Lock Washer, 3/8 inch, external teeth, for carriage bolt on idler assemblies Nos. 29470 P, 29470 Q -----	7
652 C-9	Swinging Plate Spring Washer -----	7
660-112	Spring and Catch, for holding trays to table top----	10
660-118	Cork Insulating Pad, for side cover, left -----	-
660-127	Isolated Insulator Height Adjusting Felt Washer (set of 8) for isolated insulated installation -----	9
660-128	Screw Eye, 1 1/4 inches long, for knee press assembly No. 21691 -----	24
660-168	Knee Press Pad (rubber) -----	18
660-240	Thread Tweezers -----	10
660-264	"S" Hook, for treadle chain -----	17
666-1	Elbow Oil Cup, for main shaft bearing-----	9
666-11	Looper Avoid Shaft Oil Cup; also for Nos. 39262 E, 43265 B -----	9
666-24	Looper Drive Shaft Oil Cup, for 29470 L, 29470 M	9
666-31	Oil Wick, with spring, for main shaft bearing ----	9
666-37	Needle Bar Cross Head Link Wick (screw No. 22560) -----	10
666-51	Oil Tube, for rear mainshaft bearing -----	13
666-53	Presser Arm Wick -----	9
666-61	Oil Tube, for pulley on idler assemblies Nos. 29470 P, 29470 Q -----	13
666-90	Oil Cup, for lead-in thread eyelet and oil reservoir cover No. 43165 -----	9
666-122	Felt Wick, for oil drain reservoir -----	-
666-166	Oil Drain Reservoir (glass) -----	18
666-229	Retaining Ring, for No. 666-166 -----	-
668-9	Thread Tube, porcelain, for looper thread -----	4
668-23	Steel Insert Eyelet, for side cover, left, (locking ring No. 21114 M) -----	-
668-27	Lead-in Thread Eyelet, and for reservoir cover (locking ring No. 21114 M) -----	13
Y676	Expansion Reamer, for main shaft, size .437 inch-	18
719	Set Screw, for looper lever shaft bushing; also No. 43455 -----	5
907	Cloth Plate Spring Screw Lock Nut, also Nos. 22707, 39243 H -----	7
1741 A	Pin, for presser foot chain knife, for Styles 43200 D, 43200 F-----	3
1741 B	Presser Foot Chain Knife, for Styles 43200 D, 43200 E (screw 605, 91 A) -----	3
2339 F	Looper Drive Shaft Collar (screw No. 98)-----	7
6042 A	Looper Drive Shaft Arm Stud Washer, front-----	7
6405 W	Feed Dog, for Style 43200 C (screw No. 93)-----	2
6420 W	Presser Foot, for Styles 43200 B, 43200 C -----	3
6430	Presser Foot Shank, for Styles 43200 B, 43200 C (clamp screw No. 91) -----	-
6430 A	Presser Foot Bottom, for Styles 43200 B, 43200 C -	-

LIST OF PARTS

Symbol to Order By	The figures in the last column refer only to the plates illustrating the parts and are not to be used in ordering. Prices furnished on application.	Plate No.
8372 A	Locking Stud Washer, for looper drive ball joint---	7
9271	Shaft Collar, for knee press assembly No. 21691 (screw No. 98)-----	14
12934 A	Nut, for lifter lever arm-----	6
12990	Idler Pulley Shaft Arm Support Nut, for No. 29470 Q	7
14546	Feed Rocker Shaft (set screw No. 531) -----	16
14649	Looper Rocker Shaft Collar -----	7
14775 A	Throw-out Edge Guide Spring, for closing gloves --	9
15438 C	Nipper Spring, for Style 43200 F-----	7
15465 F	Looper Rocker Cone (screw No. 22894 W) -----	8
16161 L	Idler Pulley Fiber Washer, for idler assemblies --	7
16241	Binder Support Sliding Plate Latch Spring for Styles 43200 A, 43200 B (screw No. 605) -----	9
16675	Throw-out Edge Guide Roller, for closing gloves --	8
16676	Throw-out Edge Guide Roller Pin-----	5
21104 B-20	Thread Stand Rod, 20 inches long (screw No. 22651 CD-4) -----	24
21104 H	Nut, for No. 22871 on assembly No. 29470 M, 29470 Q -----	7
21104 V	Pad, 5 inch diameter; for spool seat disc -----	26
21114	Thread Stand Spool Seat Disc -----	26
21114 A	Thread Stand Base (screw No. 22651 CD-4) -----	26
21114 D-2	Thread Stand Seat, two cones (screw No. 22651 CD-5) -----	26
21114 D-4	Thread Stand Seat, four cones (screw No. 22651 CD-5) -----	26
21114 H-2	Thread Stand Eyelet Support, two cones (screw No. 22651 CD-4) -----	26
21114 H-4	Thread Stand Eyelet Support, four cones (screw No. 22651 CD-4) -----	26
21114 L	Steel Insert, for No. 21114 D, 21114 H -----	26
21114 M	Locking Ring, for steel insert eyelet -----	23
21114 W	Spool Pin (washer No. 652-16, nut No. 258 A)-----	26
21169 D	Binding Holder Assembly, for Styles 43200 A, 43200 B; includes one each Nos. 161, 21169 E, 21169 F. Specify component parts when ordering -	25
21169 E	Binding Holder Disc, for Styles 43200 A, 43200 B -	25
21169 F	Binding Holder Base, for Styles 43200 A, 43200 B -	25
21201	Screw Driver, 9/64 inch round blade, length over all 7 11/16 inches -----	23
21202	Screw Driver, 3/16 inch round blade, length over- all 10 3/4 inches -----	23
21203	Screw Driver, 3/16 inch round blade, length over- all 11 3/8 inches -----	23
21204	Screw Driver, 7/32 inch round blade, length over- all 15 inches -----	23
21205 A	Screw Driver, 3/8 inch round blade, length over- all 14 5/8 inches -----	23
21207	Screw Driver, 7/64 inch round blade, length over- all 2 1/2 inches -----	17
21208	Screw Driver Set, three detachable blades -----	23
21210	Looper Collar, .040 inch thick -----	7

LIST OF PARTS

Symbol to Order By	The figures in the last column refer only to the plates illustrating the parts and are not to be used in ordering. Prices furnished on application.	Plate No.
21210 A	Looper Collar, .020 inch thick -----	7
21211	Looper Collar, .054 inch thick -----	7
21225-1/8	Looper Adjusting Gauge, 1/8 inch measurement--	9
21225 A	Looper Gauge, universal adjustment -----	9
21236	Belt Plier, for 3/8 inch and smaller round belting	23
21260	Emery Cord, 3/64 inch diameter, grade No. 120, fifty yard spool -----	-
21260 A	Emery Cord, 3/64 inch diameter, grade No. 150, fifty yard spool -----	-
21260 B	Emery Cord, 1/32 inch diameter, grade No. 180, fifty yard spool -----	-
21260 C	Emery Cord, .030 inch diameter, grade No. 200, fifty yard spool -----	-
21260 D	Emery Tape, 3/32 inch wide, grade No. 180, fifty yard spool -----	-
21260 E	Emery Cord, .018 inch diameter, grade No. 200, fifty yard spool -----	-
21262 D-66	Leather Belt, round, 3/8 inch diameter, 66 inches long, for connecting line shaft pulley and transmitter; includes belt hook No. 21351 A-----	-
21262 E-72	Leather Belt, round, 1/4 inch diameter, for idler assemblies Nos. 29470 L, 29470 M; includes belt hook No. 21351 B -----	19
21300 B-3 1/2	Carriage Bolt, 3/8 x 3 1/2 inches, for "Electro Drive" -----	-
21300 B-4	Carriage Bolt, 3/8 x 4 inches long, for Nos. 29470 P, 29470 Q -----	-
21300 B-5	Carriage Bolt, 3/8 x 5 inches -----	-
21351	Wire Belt Hook, for 9/32 inch round belt -----	9
21351 A	Wire Belt Hook, for 3/8 inch round belt -----	9
21351 B	Wire Belt Hook, for 1/4 inch round belt -----	9
21355	Chair Leg Extension, 4 inches long -----	13
21365 A	Flat Head Stove Bolt, 1/4 x 2 1/4 inches, for idler pulley shaft arm support plate on idler assembly No. 29470 P -----	-
21369 C	Spring, for tray No. 21376 G -----	17
21369 D	Spring Catch, for tray No. 21376 G -----	17
21371 BT-42	Blank Table Top, 42 inches long -----	-
21371 BV-48	Table Top, 48 inches long, for semi-submerged installation on open line shaft tables and Singer Safety Tables having one line shaft -----	-
21371 BW-48	Table Top, 48 inches long, for semi-submerged installation on American Safety Tables and Singer Safety Tables having two line shafts -----	-
‡21375 AB	Belt Guard, for idler assembly No. 29470 L (attaching screw No. HA61 D) -----	25
21376 G	Tray, bakelite, for non-submerged installations -	25

‡See Page 6

LIST OF PARTS

Symbol to Order By	The figures in the last column refer only to the plates illustrating the parts and are not to be used in ordering. Prices furnished on application.	Plate No.
21376 H	Tray, wood, for semi-submerged installations of machines with small handwheel -----	25
21376 J	Idler Pulley Cover, wood, for idler assembly No. 29470 M (spring and catch No. 660-112) ---	-
21376 K	Tray, wood, for semi-submerged installations of machines with large handwheel -----	25
21377 AM	Tray, wood, pivoted, for right side of Style 43200 D -----	-
21387 G	Cloth Plate Supplemental Plate, for Styles 43200 C, 43200 F (screw No. 22585, washer No. 358 A, nut No. 41071 G) -----	13
21388	Wrench, single end, 3/8 inch opening -----	17
21388 N	Wrench, double end, 3/16 and 5/16 inch openings	17
21388 R	Wrench, double end, 3/8 and 1/2 inch openings -	17
21388 U	Wrench, single end, 3/4 inch opening for needle bar bearing nut -----	17
21393 P	Spring, for No. 666-166 -----	18
21394 G	Emery Wheel, 5 inches diameter, 1/4 inch face, 3/8 inch hole, grade "M" emery 60 -----	-
21394 H	Emery Wheel, 5 inches diameter, 1/2 inch face, 3/8 inch hole, grade "M" emery 60 -----	-
21398 T	Idler Pulley, for idler assemblies -----	14
21398 AG	Idler Pulley Shaft, for idler assemblies No. 29470 L, 29470 M, 29470 P, 29470 Q plug screw No. 22586, set screw No. 22591, leather wiper No. 21398 V -----	13
21657 E	Washer, for No. 51292 G, for Style 43800 A ----	7
21661	Shaft, for knee press assembly No. 21691 -----	18
21662	Bracket, for knee press assembly No. 21691----	24
21664	Plate, for knee press assembly No. 21691 (set screw No. 69 FD) -----	24
21665	Rod Connection, for knee press assembly No. 21691 (set screw No. 69 FD)-----	18
21677	Plate Rod, for knee press assembly No. 21691 (set screw No. 69 FD) -----	23
21679	Chain Rod, for knee press assembly No. 21691 (set screw No. 69 FD) -----	18
21680 AA	Base Plate, for idler assembly No. 29470 L ----	21
21680 AF	Base Plate, for idler assembly No. 29470 M ----	22
21680 AL	Base Plate, for idler assembly No. 29470 Q ----	22

LIST OF PARTS

Symbol to Order By	The figures in the last column refer only to the plates illustrating the parts and are not to be used in ordering. Prices furnished on application.	Plate No.
21680 AM 21691	Base Plate, for idler assembly No. 29470 P----- Knee Press Assembly, for Style 43200 D; includes one each Nos. 421 D-10, 660-128, 21661, 21662, 21664, 21677, 21679, 28505; two each Nos. 9271, 21665. Specify component part when ordering -----	24 24
21697 A	Electro Drive Adjustment Bracket, for idler assemblies Nos. 29470 P, 29470 Q (bolt No. 21300 B-4) -----	22
21698-2	Vibration Insulator, two inches long, for tables--	12
21698-4	Vibration Insulator, four inches long -----	12
21698-5	Vibration Insulator, five inches long -----	12
21698-6	Vibration Insulator, six inches long ----- Note: Special lengths will be furnished on request. Part of the table leg is shown in the illustration for clarity	12
22508	Set Screw, square head, cup point, 1/4 inch diameter, 20 threads to inch, 1/2 inch long ----	6
22516	Adjusting Screw, for feed dog holder -----	6
22537	Set Screw, for looper drive shaft -----	5
22542	Screw, for presser spring tube clamp; also for No. 43455 -----	5
22560	Screw, for needle bar cross head link wick and needle set screw on Style 43800 A -----	5
22560 B	Set Screw, for feed bar bushing -----	5
22564	Screw, for swinging plate spring latch -----	5
22571 A	Plug Screw, for presser arm wick chamber -----	6
22571 B	Pipe Plug, 3/8 inch long, 1/8 inch pipe thread---	5
22582	Shoulder Screw, for pulley assembly on Style 43200 F -----	6
22585	Screw, for needle bar cross head guide block; also for No. 21387 G on Styles 43200 C, 43200 F	5
22586	Plug Screw, for idler pulley shaft on idler assemblies Nos. 29470 L, 29470 M, 29470 P, 29470 Q -----	5
22586 A	Screw, hollow, for rear end of looper drive shaft	5
22587 E	Screw, 19/32 inch long, for looper drive eccentric bearing; also for No. 29126 K, 29126 N, 29126 P, 29126 S, 29126 V, 29126 W, 29126 AJ -	6
22588 A	Screw, 11/32 inch long, hexagonal head for cloth plate spring (lock nut No. 907) -----	6
22591	Set Screw, for idler pulley shaft on idler assemblies Nos. 29470 L, 29470 M, 29470 P, 29470 Q -----	5
22593	Screw, for binder support sliding plate guide spring on Styles 43200 A, 43200 B -----	5
22596	Screw, 5/8 inch long, for feed dog; also for Nos. 43294 A, 43425 B, 43459 -----	6
22597 A	Lock Screw, for feed lift ball joint -----	5
22632 F-24	Set Screw, square head, cup point, 3/16 inch diameter, 3/8 inch long, 24 threads to inch, for thread stand wire -----	5
22651 CD-3	Set Screw, headless socket type, cup point 3/16 inch long, 1/4-28 NF thread -----	5

LIST OF PARTS

Symbol to Order By	The figures in the last column refer only to the plates illustrating the parts and are not to be used in ordering. Prices furnished on application.	Plate No.
22651 CD-4	Screw, for thread stand base; also for No. 21114 H-2, 21114 H-4 -----	26
22651 CD-5	Screw, headless, for thread stand seat-----	5
22707	Screw, 5/64 inch long, hexagonal head, for cloth plate spring; also for No. 43281 H, 43281 M, 43853 -----	6
22711	Screw, for right side cover -----	5
22726	Screw, for throw-out edge guide lever on glove closing machines -----	5
22729 C	Screw, for feed lift ball joint bearing -----	-
22747	Screw, for ball joint fork No. 39144 V, 41255 B--	5
22760	Screw, for binder support sliding plate latch on Styles 43200 A, 43200 B -----	5
22764	Spot Screw, for main shaft eccentrics-----	5
22764 A	Screw, for lifter lever arm -----	6
22766	Screw, for lead-in thread eyelet and oil reservoir cover -----	5
22768	Screw, for frame needle thread pull-off -----	5
22791 B	Screw Pin, cone point, for main shaft crank pin--	6
22799 B	Hinge Screw, 37/64 inch long, for presser foot on Styles 43200 A, 43200 E, 43200 F, 43800 A --	5
22799 E	Hinge Screw, 41/64 inch long, for presser foot on Styles 43200 B, 43200 C -----	-
22799 F	Screw, 5/16 inch long, for separating needle threads, Style 43800 A -----	-
22799 G	Hinge Screw, 25/64 inch long, for presser foot on Style 43200 D -----	5
22806 A	Screw, for looper avoid adjusting arm-----	6
22813	Screw, headless, for lifter treadle pin No. 424---	5
22823 A	Screw, for attaching machine to metal base plate -	6
22829	Lock Screw, for looper rocker cone; also for No. 43201 -----	5
22834	Screw, for adjusting needle guard on Style 43200 F	5
22840 A	Stop Screw, for presser foot on Style 43200 A, 43200 B, 43200 C (lock nut No. 51430 F) -----	5
22843	Thumbscrew, for regulating presser spring-----	6
22848	Screw, for left side cover; also for Nos. 23444, 23444 E, 23444 F, 39262 E, 43225, 43262 J, 43281 J, 43825-----	5
22871	Screw, for base plate on idler assemblies Nos. 29470 M, 29470 Q (nut No. 21104 H)-----	13
22872	Screw, for frame needle thread eyelet on Style 43800 A -----	6
22894 W	Screw, for looper rocker cone -----	6
23215 BC-5/8	Binder, 5/32 inch capacity for body fabric, for selvage edge and prefolded binding 5/8 inch wide, on Style 43200 B (screw No. 90) -----	15
23215 BC-3/4	Binder, for selvage edge and prefolded binding 3/4 inch wide (screw No. 90) -----	15
23215 BC-7/8	Binder, for selvage edge and prefolded binding 7/8 inch wide (screw No. 90) -----	15
23322 AB-3/4	Binder, 1/8 inch capacity for body fabric, for cut edge binding 3/4 inch wide, 7/32 inch finish, on Style 43200 A (screw No. 90) -----	15

LIST OF PARTS

Symbol to Order By	The figures in the last column refer only to the plates illustrating the parts and are not to be used in ordering. Prices furnished on application.	Plate No.
23322 AB-7/8	Binder, 1/8 inch capacity for body fabric, for cut edge binding 7/8 inch wide, 1/4 inch finish -----	15
23322 AB-1	Binder, 1/8 inch capacity for body fabric, for cut edge binding 1 inch wide, 9/32 inch finish -----	15
23322 AB-1 1/8	Binder, 5/32 inch capacity for body fabric, for cut edge binding 1 1/8 inches wide, 11/32 inch finish -	15
23322 AB-1 1/4	Binder, 5/32 inch capacity for body fabric, cut edge binding 1 1/4 inches wide, 13/32 inch finish (screw No. 90) -----	15
23410 A-3/8	Hemmer, for No. 12 gauge, Style 43800 A (screw No. 25 C) -----	15
23439 A	Pin Tension, for Styles 43200 A, 43200 B (screw No. 87) -----	14
23444	Binder Support Sliding Plate Assembly, for Styles 43200 A, 43200 B; includes one each Nos. 605, 16241, 22760, 23444 B, 23444 C, 23444 D, 23444 E, 23444 H; two No. 22593 (attaching screw No. 22848, adjusting stop screw No. 95) -----	14
23444 A	Binder Support, for Style 43200 A (screw No. 90) --	14
23444 B	Binder Support Sliding Plate, for assembly No. 23444 -----	-
23444 C	Binder Support Sliding Plate Guide, for assembly No. 23444 -----	-
23444 D	Binder Support Sliding Plate Guide Spring, for assembly No. 23444 (screw No. 22593) -----	-
23444 E	Binder Support Sliding Plate Bracket, for assembly No. 23444 (attaching screw No. 22848, adjusting stop screw No. 95) -----	-
23444 F	Swinging Plate Bracket, for Styles 43200 A, 43200 B (screw No. 22848) -----	14
23444 G	Swinging Plate Bracket Washer -----	7
23444 H	Binder Support Sliding Plate Latch, for assembly No. 23444 (screw No. 22760) -----	-
23444 N	Binder Support, for Style 43200 B (screw No. 90) --	14
28505	Chain Rod Spring, for knee press assembly No. 21691 -----	17
‡29126 D	Looper Drive Eccentric Assembly; includes eccentric No. 43448, throw .160 inch, for Styles 43200 A, 43200 B, 43200 C, 43200 D, 43200 E, 43200 F, 43800 A (set screw No. 88, spot screw No. 22764, bearing screw No. 22587 E) -----	12
‡29126 K	Looper Avoid Eccentric Assembly; includes eccentric No. 43214 K, throw .160 inch, for Style 43800 A (set screw No. 88, spot screw No. 22764, bearing screw No. 22587 E) -----	12
‡29126 N	Feed Drive Eccentric Assembly; includes eccentric No. 39140 D, throw .066 inch, for Styles 43200 A, 43200 F (set screw No. 88, spot screw No. 22764, bearing screw No. 22587 E) -----	12

‡See Page 6

LIST OF PARTS

Symbol to Order By	The figures in the last column refer only to the plates illustrating the parts and are not to be used in ordering. Prices furnished on application.	Plate No.
‡29126 P	Looper Avoid Eccentric Assembly; includes eccentric No. 39340, throw .140 inch, for Styles 43200 A, 43200 B, 43200 C, 43200 D, 43200 E, 43200 F (set screw No. 88, spot screw No. 22764, bearing screw No. 22587 E)-----	12
‡29126 S	Feed Drive Eccentric Assembly; includes eccentric No. 43440 G, throw .096 inch, for Styles 43200 B, 43200 C, 43200 D, 43200 E, 43800 A (set screw No. 88, spot screw No. 22764, bearing screw No. 22587 E)-----	12
‡29126 V	Feed Lift Eccentric Assembly; includes eccentric No. 39306, throw .080 inch, for Styles 43200 E, 43800 A (set screw No. 88, spot screw No. 22764, bearing screw No. 22587 E)-----	12
‡29126 W	Feed Lift Eccentric Assembly; includes eccentric No. 39206, throw .110 inch, for Styles 43200 A, 43200 B, 43200 C, 43200 D (set screw No. 88, spot screw No. 22764, bearing screw No. 22587 E)-----	12
‡29126 AJ	Feed Lift Eccentric Assembly; includes eccentric No. 43206, throw .080 inch, for Style 43200 F (set screw No. 88, spot screw No. 22764, bearing screw No. 22587 E)-----	12
29192	Looper Rocker Assembly, for Styles 43200 A, 43200 B, 43200 C, 43200 D, 43200 E, 43200 F; includes one each Nos. 51213, 258 A, 15465 F, 22829, 51745-----	14
29192 A	Looper Rocker Assembly, for Style 43800 A; includes one each Nos. 51413, 258 A, 15465 F, 22829, 51745-----	14
29402	Lifter Treadle Assembly; includes one each Nos. 423, 424, 22813-----	21
29470 L	Idler Assembly and Base Plate, for non-submerged group, isolated installation on American Safety Table and Singer Safety Table having two line shafts; includes one each Nos. 660-127, 21262 E-72, 21375 AB, 21680 AA; two each Nos. 666-24, 21398 T, 21398 AG, 39153 G, 39195, 39195 A; three No. 22823 A; four each Nos. HA61 D, 16161 L, 22591, 51295 A-----	19
29470 M	Idler Assembly and Base Plate, for semi-submerged group, isolated installation on American Safety Table and Singer Safety Table having two line shafts; includes one each Nos. 93, 21262 E-72, 21376 J, 21680 AF, 33189 C; two each Nos. 666-24, 21398 T, 21398 AG, 39153 G, 39195, 39195 A; three No. 22823 A; four each Nos. 16161 L, 22591, 22871, 51295 A; eight No. 21104 H-----	19

‡See Page 6

LIST OF PARTS

Symbol to Order By	The figures in the last column refer only to the plates illustrating the parts and are not to be used in ordering. Prices furnished on application.	Plate No.
29470 P	Adjustable Idler Assembly and Base Plate, for non-submerged line assembly installation with "Electro Drive"; includes one each Nos. 666-61, 21398 T, 21398 AG, 21680 AM, 21697 A, 39153 G, 39195, 39195 A, 39195 B; two each Nos. 652 B-16, 16161 L, 21365 A, 22591; three each Nos. 650 G-10, 652-20, 652 B-24, 21300 B-4, 22823 A; four No. 51295 A -----	20
29470 Q	Adjustable Idler Assembly and Base Plate, for semi-submerged, line assembly installation with "Electro Drive"; includes one each Nos. 666-61, 12990, 21398 T, 21398 AG, 21680 AL, 21697 A, 39195, 39195 A; two each Nos. 16161 L, 22591; three each Nos. 650 G-10, 652-20, 652 B-24, 21300 B-4, 22823 A; four each Nos. 22871, 51295 A; eight No. 21104 H -----	20
29477 EB	Feed Lift Eccentric Connecting Rod Assembly, for Style 43200 F; one each Nos. 29126 AJ, 18, 269, 22597 A, 43235, 43235 F, 43236. Assembly is set to gauge before shipment. The approximate distance between centers is 3 39/64 inches -----	11
29477 EC	Feed Drive Eccentric Connecting Rod Assembly, for Styles 43200 A, 43200 F; one each Nos. 29126 N, 18, 269, 22747, 39141, 41255 B, 43241 D. Assembly is set to gauge before shipment. The approximate distance between centers is 4 1/32 inches -----	11
29477 ED	Looper Avoid Connecting Rod Assembly, for Styles 43200 A, 43200 B, 43200 C, 43200 D, 43200 E, 43200 F; one each Nos. 29126 P, 18, 269, 22747, 41255 B, 43241 D, 43246. Assembly is set to gauge before shipment. The approximate distance between centers is 5 11/64 inches -----	11
29477 EE	Looper Drive Connecting Rod Assembly, for Styles 43200 A, 43200 B, 43200 C, 43200 D, 43200 E, 43200 F, 43800 A; one each Nos. 29126 D, 18, 269, 22747, 39144 V, 43243 H, 43244. Assembly is set to gauge before shipment. The approximate distance between centers is 5 3/8 inches -----	11
29477 FB	Feed Lift Eccentric Connecting Rod Assembly, for Styles 43200 E, 43800 A; one each Nos. 29126 V, 18, 269, 41047, 43235, 43235 G. Assembly is set to gauge before shipment. The approximate distance between centers is 3 17/32 inches -----	11
29477 FC	Feed Lift Eccentric Connecting Rod Assembly, for Styles 43200 A, 43200 B, 43200 C, 43200 D; one each Nos. 29126 W, 18, 269, 41047, 43235, 43235 G. Assembly is set to gauge before shipment. The approximate distance between centers is 3 1/2 inches -----	11

LIST OF PARTS

Symbol to Order By	The figures in the last column refer only to the plates illustrating the parts and are not to be used in ordering. Prices furnished on application.	Plate No.
29477 FD	Feed Drive Eccentric Connecting Rod Assembly, for Styles 43200 B, 43200 C, 43200 D, 43200 E, 43800 A; one each Nos. 29126 S, 18, 269, 22747, 39141, 41255 B, 43241 D. Assembly is set to gauge before shipment. The approximate distance between centers is 4 1/64 inches -----	11
29477 FE	Looper Avoid Eccentric Connecting Rod Assembly, for Style 43800 A; one each Nos. 29126 K, 18, 269, 22747, 41255 B, 43241 D, 43246. Assembly is set to gauge before shipment. The approximate distance between centers is 5 5/32 inches -----	11
31562	Tension Post Ferrule, for oil reservoir cover ----	4
33189 C	Stop Washer, for lifter lever on machines installed with idler assembly No. 29470 M (screw No. 93) -	7
35737 A	Front Swinging Plate Bushing -----	8
39117	Needle Bar, .257 inch diameter; includes clamp nut No. 39151, for all Styles in Class 43200 (set screw No. 88)-----	16
39121	Pulley, working diameter 2 1/4 inches, for Styles 43200 A, 43200 B, 43200 C, 43200 D, 43200 E, 43800 A (spot screw No. 96, set screw No. 98) ---	14
39135	Feed Bar Shaft, standard diameter .319 inch (screw No. 89) -----	16
39140 V	Feed Rocker Shaft Bushing, right (screw No. 531) -	8
39141	Feed Drive Eccentric Connecting Rod, for all Styles in Class 43200 and 43800 A (nut, right thread No. 18; nut, left thread No. 269) -----	16
39142 H	Looper Drive Shaft Bushing -----	8
39144 V	Looper Drive Ball Joint Fork (screw No. 22747)---	10
39151	Needle Clamp Nut, for all Styles in Class 43200 ---	7
39152	Needle Bar Cross Head (screw No. 88)-----	10
39152 U-4	Needle Bar Cross Head Guide Block Shim, .004 inch thick -----	12
39152 U-5	Needle Bar Cross Head Guide Block Shim, .005 inch thick -----	12
39152 U-6	Needle Bar Cross Head Guide Block Shim, .006 inch thick -----	12
39152 U-7	Needle Bar Cross Head Guide Block Shim, .007 inch thick -----	12
39152 U-8	Needle Bar Cross Head Guide Block Shim, .008 inch thick -----	12
39152 U-9	Needle Bar Cross Head Guide Block Shim, .009 inch thick -----	12
39153 G	Needle Bar Bearing Nut, 5/32 inch thick, for all Styles in Class 43200; also for Nos. 29470 L, 29470 M, 29470 P -----	7
39155 N	Lifter Lever Spring -----	9
39157	Presser Spring (regulating screw No. 22843)-----	9
39157 G	Presser Spring Plunger -----	16
39157 H	Presser Bar Spring Bushing, including nuts, for Styles 43200 A, 43200 C, 43200 D, 43200 E, 43200 F, 43800 A (nut No. 39157 K) -----	16

LIST OF PARTS

Symbol to Order By	The figures in the last column refer only to the plates illustrating the parts and are not to be used in ordering. Prices furnished on application.	Plate No.
39157 J	Presser Spring Tube Clamp (screw No. 22542)----	10
39157 K	Presser Spring Tube Nut, for No. 39157 H, 43457 -----	7
39162 C	Belt Guard (screw No. 22848)-----	25
39190	Main Shaft Bushing, front, 57/64 inch long -----	8
39190 G	Main Shaft Bushing, rear, 1 17/64 inches long----	8
39191 G	Main Shaft Crank Pin (screw No. 22791 B)-----	8
39193 A	Oil Reservoir Glass Tube Cover-----	8
39195	Idler Pulley Shaft Arm, for idler assemblies Nos. 29470 L, 29470 M, 29470 P, 29470 Q (set screw No. 22591) -----	13
39195 A	Idler Pulley Shaft Arm Support (set screw No. 22591) -----	13
39195 B	Idler Pulley Shaft Arm Support Plate, for idler assembly No. 29470 P (bolt No. 21365 A, washer No. 652 B-16) -----	14
39243 H	Locking Stud, for looper drive ball joint on Styles 43200 A, 43200 F (nut No. 907, washer No. 8372 A) -----	10
39252 N	Needle Bar Cross Head Guide Block (screw No. 22585) -----	10
39253	Needle Bar Bearing, for all Styles in Class 43200 (nut No. 39153 G) -----	12
39262 E	Assembled Oil Reservoir (screw No. 22848)-----	18
41047	Feed Lift Eccentric Connecting Rod, for Styles 43200 A, 43200 B, 43200 C, 43200 D, 43200 E, 43800 A (nut, right thread No. 18; nut, left thread No. 269) -----	10
41071 G	Cloth Plate Supplemental Plate Screw Nut, for Styles 43200 C, 43200 F -----	7
41255 B	Looper Avoid and Feed Drive Ball Joint Fork (screw No. 22747) -----	8
43140	Feed Rocker -----	12
43140 U	Feed Rocker Shaft Bushing, left (screw No. 531) --	8
43165	Lead-in Thread Eyelet and Oil Reservoir Cover (screw No. 22766)-----	-
43201	Cloth Plate, for Styles 43200 C, 43200 D, 43200 E, 43200 F, 43800 A -----	25
43201 B	Cloth Plate, for Styles 43200 A, 43200 B -----	25
43203 D	Edge Guide, for Style 43200 D (screw No. 25)-----	13
43205 B	Feed Dog, for Style 43200 B (screw No. 93) -----	2
43208 D	Looper, for all Styles in Class 43200 (screw No. 73)	3
43210 D	Looper Needle Guard, for all Styles in Class 43200 (screw No. 73 A)-----	3
43220 A	Presser Foot Assembly, for Style 43200 A -----	3
43220 D	Presser Foot Assembly, for Style 43200 D -----	3
43220 E	Presser Foot Assembly, for Style 43200 E -----	3
43220 F	Presser Foot Assembly, for Style 43200 F -----	3
‡43221 G	Pulley Assembly, working diameter 2 1/4 inches for Style 43200 F (spot screw No. 96, set screw No. 98, shoulder screw No. 22582) -----	14

‡See Page 6

LIST OF PARTS

Symbol to Order By	The figures in the last column refer only to the plates illustrating the parts and are not to be used in ordering. Prices furnished on application.	Plate No.
43222	Main Shaft, including crank pin No. 39191 G, for Styles 43200 A, 43200 B, 43200 C, 43200 D, 43200 E, 43800 A -----	23
43222 F	Main Shaft, including crank pin No. 39191 G, for Style 43200 F-----	23
43224	Throat Plate, for Style 43200 D (screw No. 28) ---	1
43224 C	Throat Plate, for Style 43200 C (screw No. 28) ---	1
43224 F	Throat Plate, for Styles 43200 E, 43200 F (screw No. 28) -----	1
43225	Needle Guard, for Styles 43200 A, 43200 B, 43200 C, 43200 D, 43200 E (screw No. 22848) ---	3
43228 A	Throat Plate, for Style 43200 A (screw No. 28) ---	1
43228 B	Throat Plate, for Style 43200 B (screw No. 28) ---	2
43230	Presser Foot Shank, for Style 43200 D -----	-
43230 A	Presser Foot Bottom, for Style 43200 A-----	-
43230 B	Presser Foot Finger Guard, for Style 43200 D (screw No. 605)-----	3
43230 D	Presser Foot Bottom, for Style 43200 D -----	-
43230 E	Presser Foot Bottom, for Style 43200 E -----	-
43230 G	Presser Foot Shank, for Style 43200 E (clamp screw No. 91) -----	-
43230 H	Presser Foot Shank, for Style 43200 F (clamp screw No. 91) -----	-
43230 J	Presser Foot Bottom, for Style 43200 F-----	-
43230 U	Presser Foot Knife, for Style 43200 F (screw No. 91 A) -----	-
43232	Cloth Plate Spring (screw, short, No. 22588 A; screw long, No. 22707; nut No. 907) -----	4
43232 N	Cloth Plate Pivot Pin (screw No. 531)-----	8
43232 R	Cloth Plate Pivot Pin Spring Washer -----	7
43234	Feed Bar (screw No. 89) -----	13
43235	Feed Bar Bushing, threaded (set screw No. 22560 B and 22597 A)-----	8
‡43235 F	Feed Lift Ball Joint, for Style 43200 F (bearing screw No. 22729 C, lock screw No. 22597 A) ----	8
‡43235 G	Feed Lift Ball Joint, for Styles 43200 A, 43200 B, 43200 C, 43200 D, 43200 E, 43800 A (bearing screw No. 22729 C, lock screw No. 22597 A) ----	8
43236	Feed Lift Eccentric Connecting Rod, for Style 43200 F (nut, right thread, No. 18; nut, left thread, No. 269) -----	16
43237	Feed Drive and Looper Avoid Ball Joint Nut -----	7
43239	Feed Dog Holder (adjusting screw No. 22516, stop screw for maintaining height of feed dog No. 97) -	14
43239 G	Feed Dog Holder Adjusting Screw Nut -----	7
43241 A	Stitch Regulating Stop -----	10
‡43241 D	Feed Drive and Looper Avoid Ball Joint (bearing screw No. 97 A, nut No. 43237) -----	8
43242	Looper Drive Shaft Arm, front (clamp stud No. 43242 J, nut No. 51246, washer No. 6042 A) -----	14
43242 H	Looper Drive Shaft Arm, rear -----	16
43242 J	Front Looper Drive Shaft Arm Clamp Stud -----	6

‡See Page 6

LIST OF PARTS

Symbol to Order By	The figures in the last column refer only to the plates illustrating the parts and are not to be used in ordering. Prices furnished on application.	Plate No.
43243	Looper Drive Shaft (set screw No. 22537, rear end screw No. 22586 A) -----	16
‡43243 H	Looper Drive Ball Joint (bearing screw No. 97 A, locking stud 39243 H, locking stud washer 8372 A)	8
43243 N	Looper Lever Shaft Bushing (screw No. 719) -----	-
43244	Looper Drive Eccentric Connecting Rod (nut, right thread, No. 18; nut, left thread No. 269)---	16
43245	Looper Rocker Frame (spot screw No. 96, set screw No. 98) -----	10
43245 E	Looper Avoid Shaft -----	16
43245 H	Looper Avoid Adjusting Arm (clamp screw No. 22806 A)-----	14
43245 N	Looper Avoid Shaft Bushing -----	7
43246	Looper Avoid Eccentric Connecting Rod (nut, right thread, No. 18; nut, left thread No. 269)---	16
43254	Needle Bar Link (screw No. 22560) -----	16
43255 A	Lifter Lever, for Style 43200 F -----	13
43255 B	Lifter Lever, for Styles 43200 A, 43200 B, 43200 C, 43200 D, 43200 E, 43800 A (stop pin No. 42 A)-----	13
43256 A	Presser Arm -----	24
43256 G	Presser Arm Bushing -----	8
43261	Needle Bar Cover -----	21
43261 D	Needle Bar Cover Hinge Pin-----	16
43262	Side Cover, right (screw No. 22711) -----	21
43262 J	Side Cover, left (screw No. 22848)-----	25
43264	Needle Bar Link Thread Eyelet, for needle thread (screw No. 87 U)-----	4
43264 E	Needle Bar Link Thread Eyelet, for looper thread on Styles 43200 A, 43200 B, 43200 C, 43200 D, 43200 E, 43200 F (screw No. 87 U) -----	4
43264 R	Frame Needle Thread Pull-off Eyelet (screw No. 73 A) -----	4
43264 V	Frame Looper Thread Eyelet, adjustable, for Styles 43200 A, 43200 B, 43200 C, 43200 D, 43200 E, 43200 F (screw No. 88) -----	4
43266	Tension Post Nut -----	7
43268	Frame Looper Thread Guide (screw No. 98 A) ---	4
43278	Fabric Guard, for Styles 43200 A, 43200 B, 43200 C, 43200 D, 43200 E (screw No. 187 A)---	15
43278 A	Fabric Guard, for Style 43800 A (screw No. 187 A)	15
43278 C	Fabric Guard, for Style 43200 F (screw No. 90) --	15
43279 A	Supplemental Plate, right, for cloth plate on Styles 43200 A, 43200 B (screw No. 25 C) -----	15
43279 B	Supplemental Plate, left, for cloth plate on Styles 43200 A, 43200 B (screw No. 90) -----	18
43280 A	Throat Plate Support (screw No. 376) -----	15
43281 H	Swinging Plate, front, for Styles 43200 C, 43200 D, 43200 E, 43200 F, 43800 A (screw No. 22707, nut No. 907)-----	22

‡See Page 6

LIST OF PARTS

Symbol to Order By	The figures in the last column refer only to the plates illustrating the parts and are not to be used in ordering. Prices furnished on application.	Plate No.
43281 J	Swinging Plate Bracket, for Styles 43200 C, 43200 D, 43200 E, 43200 F, 43800 A (screw No. 22848) -----	12
43281 K	Swinging Plate Spring (fillister head screw No. HS24 C, thumbscrew No. 525, washer No. 652 C-9) -----	4
43281 M	Swinging Plate, front, for Styles 43200 A, 43200 B (screw No. 22707, nut No. 907) -----	22
43294 A	Oil Drain Support (screw No. 22596) -----	18
43294 C	Oil Drain Pipe, 1 3/8 inches long -----	13
43294 D	Oil Drain Pipe, 3 3/8 inches long -----	13
43295	Plug, sheet metal, for right side of bed -----	-
43296	Nipper Spring Base, for Style 43200 F -----	-
43297	Needle Thread Take-up Spring, for Style 43200 D-	9
43297 A	Needle Thread Take-up Spring Stop, for Style 43200 D -----	4
43403 B	Throw-out Edge Guide, for closing gloves ----- Attaching Screw No. 25 C Throw-out Edge Guide Base No. 43495 Throw-out Edge Guide Slide No. 43495 B Throw-out Edge Guide Slide Plate No. 43495 A (screw No. 87 A) Throw-out Edge Guide Lever No. 43495 C (screw No. 22726) Throw-out Edge Guide Spring No. 14775 A	13
43425 B	Needle Guard, for Style 43200 F (attaching screw No. 22596, adjusting screw No. 22834, washer No. 20) -----	3
43455	Lifter Lever Arm (attaching screw No. 22764 A, clamp screw No. 93, stop screw No. 719, nut No. 12934 A) -----	10
43457	Presser Bar Spring Bushing, including nuts, for Style 43200 B (nut No. 39157 K)-----	16
43459	Needle Guard Holder, for Style 43200 F (screw No. 22596) -----	8
43464	Needle Bar Cross Head Thread Eyelet, for Styles 43200 A, 43200 B, 43200 C, 43200 D, 43200 E, 43200 F (screw No. 604) -----	4
43464 B	Frame Needle Thread Pull-off (screw No. 22768)-	4
43495	Throw-out Edge Guide Base, for closing gloves (screw No. 25 C) -----	-
43495 A	Throw-out Edge Guide Slide Plate (screw No. 87 A)	-
43495 B	Throw-out Edge Guide Slide, including roller No. 16675 and roller pin No. 16676 -----	-
43495 C	Throw-out Edge Guide Lever (screw No. 22726)--	-
43805 A-12	Feed Dog, for No. 12 gauge Style 43800 A (screw No. 93) -----	2
43808-12	Looper, front, for No. 12 gauge Style 43800 A (screw No. 73) -----	3
43809	Looper, back, for Style 43800 A (screw No. 73)--	3
43817-12	Needle Bar, .257 inch diameter, marked "BB-12", for No. 12 gauge Style 43800 A (set screw No. 88)	16

LIST OF PARTS

Symbol to Order By	The figures in the last column refer only to the plates illustrating the parts and are not to be used in ordering. Prices furnished on application.	Plate No.
43820 A-12	Presser Foot Assembly, for No. 12 gauge Style 43800 A (clamp screw No. 91) -----	3
43825	Needle Guard, for Style 43800 A (screw No. 22848, washer 36 G) -----	11
43830	Presser Foot Shank, for Style 43800 A (clamp screw No. 91) -----	-
43830 A-12	Presser Foot Bottom, for No. 12 gauge Style 43800 A -----	-
43864	Needle Bar Cross Head Thread Eyelet, for Style 43800 A (screw No. 605 A) -----	4
43864 E	Needle Bar Link Thread Eyelet, for looper thread on Style 43800 A (screw No. 87 U) -----	4
43864 G	Frame Needle Thread Eyelet, for Style 43800 A (screw No. 22872) -----	4
43864 N	Frame Looper Thread Eyelet, adjustable, for Style 43800 A (screw No. 88) -----	4
K48195	Hemmer, for 5/16" hem, for Style 43200 E (screw No. 25 C) -----	-
51205 A	Feed Dog, for Style 43200 A (screw No. 93)-----	2
51205 W	Feed Dog, for Style 43200 D (screw No. 93)-----	2
51213	Looper Rocker, marked "B", for all Styles in Class 43200 -----	14
51240 D	Looper Connecting Rod (nut, right thread, No. 18; nut, left thread, No. 269 -----	10
51242 M	Washer, for locking stud No. 52841 G (nut No. 52841 H)-----	7
51246	Looper Rocker Cone Stud Nut; also for Nos. 43242, 43242 J -----	7
51292	Tension Post -----	12
51292 A	Tension Post Ferrule-----	4
51292 C	Tension Regulating Nut -----	4
51292 D	Tension Thread Eyelet, for needle and looper thread -----	4
51292 F-1	Tension Spring, .016 inch diameter wire, for looper thread -----	9
51292 F-5	Tension Spring, .031 inch diameter wire, for needle thread -----	9
51292 G	Tension Post, 1 3/4 inches overall, for Styles 43200 B, 43200 C, 43200 D, 43200 E -----	13
51294 A	Oil Drain Clamp Spring -----	18
51295 A	Isolated Insulator, for machines mounted on base plate; also for No. 29470 L, 29470 M, 29470 P, 29470 Q -----	10

LIST OF PARTS

Symbol to Order By	The figures in the last column refer only to the plates illustrating the parts and are not to be used in ordering. Prices furnished on application.	Plate No.
51305 A	Feed Dog, for Styles 43200 E, 43200 F (screw 7/16 inch long No. 93; screw 5/8 inch long No. 22596)-----	2
51413	Looper Rocker, marked "C", for Style 43800 A -	14
51430 F	Presser Foot Stop Screw Lock Nut, for Styles 43200 A, 43200 B, 43200 C -----	7
‡51741 B	Looper Connecting Rod Ball Joint, right (bearing screw No. 97 A, nut No. 18, washer No. 36 G) -	8
51745	Looper Rocker Cone Stud (nut No. 258 A, screw No. 22829)-----	10
52841 G	Locking Stud, for looper drive ball joint on Styles 43200 B, 43200 C, 43200 D, 43200 E,	
52841 H	43800 A (nut No. 52841 H, washer No. 51242 M) Nut, for locking stud on Styles 43200 B, 43200 C,	10
53530	43200 D, 43200 E, 43800 A -----	5
55241 N	Presser Foot Shank, for Style 43200 A (screw No. 91)-----	-
‡55241 N	Looper Connecting Rod Joint, left, one each Nos. 55241 P, 55241 Q; two No. 22729 C (nut No. 18)-	8
57885 A	Swinging Plate Spring Latch (screw No. 22564) --	10

‡See Page 6

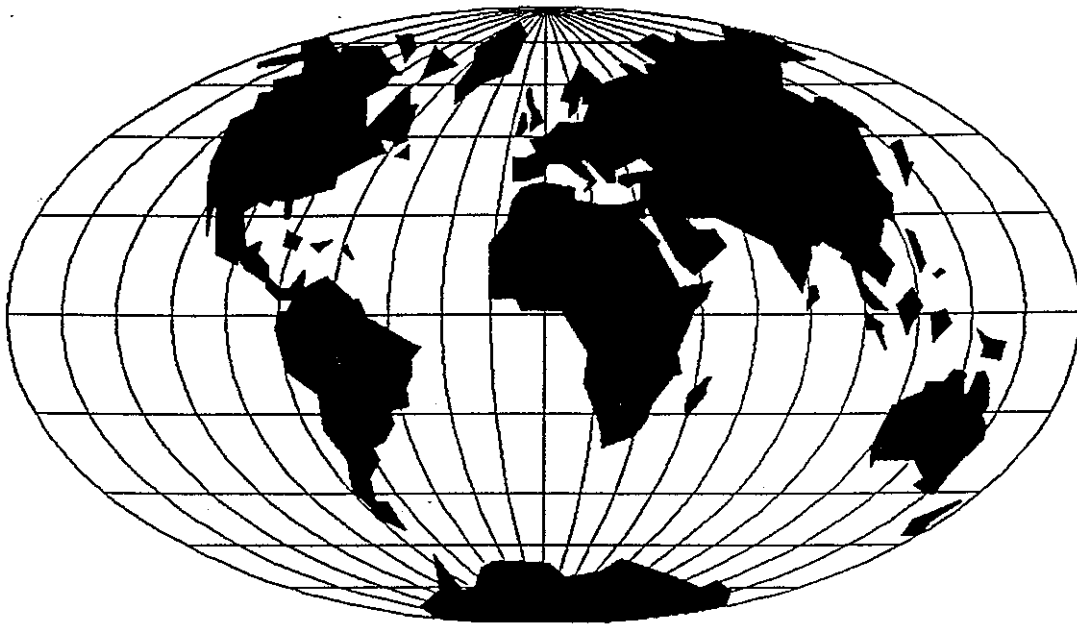

WORLDWIDE SALES AND SERVICE

Union Special Corporation maintains sales and service facilities throughout the world. These offices will aid you in the selection of the right sewing equipment for your particular operation. Union Special Corporation representatives and service technicians are factory trained and are able to serve your needs promptly and efficiently. Whatever your location, there is a qualified representative to serve you.

Corporate Office: One Union Special Plaza
Huntley, IL 60142
Phone: 847-669-5101
Fax: 847-669-4454

European Distribution Center: Union Special GmbH
Raiffeisenstrasse 3
D-71696 Möglingen, Germany
Tel: 49-07141-247-0
Fax: 49-7141-247-100

Brussels, Belgium
Charlotte, N.C.
El Paso, TX
Hong Kong, China
Huntley, IL
Leicester, England
Lille, France
Miami, FL
Milan, Italy
Möglingen, Germany
Montreal, Quebec
Osaka, Japan
Santa Fe Springs, CA

Other Representatives throughout all parts of the world.



Union Special
INDUSTRIAL SEWING EQUIPMENT