

**FIRST
EDITION**



Union Special
INDUSTRIAL SEWING EQUIPMENT

CATALOG NO. 103AB

STYLES

39500 AB

39500 AC

39500 AE

STREAMLINED HIGH SPEED OVERSEAMERS

Catalog No. 103 AB
(Supplement to Catalog No. 103 S)

INSTRUCTIONS

FOR

ADJUSTING AND OPERATING

LIST OF PARTS

CLASS 39500

Styles

39500 AB 39500 AC 39500 AE

First Edition

Copyright 1960

By

Union Special Corporation
Rights Reserved in All Countries

Union Special

CORPORATION

INDUSTRIAL SEWING MACHINES

CHICAGO

October , 1974

Printed in U.S.A.

IDENTIFICATION OF MACHINE

Each Union Special machine is identified by a Style number which is stamped into the name plate.

Machines similar in construction are grouped by a Class number, which contains no letters. Example: "39500". Letters suffixed to a Class number indicates the standard Style of a machine. Example: "39500 AB". The letter "Z" is reserved as a suffix to the standard Style identification to specify machine is of "Special" construction.

APPLICATION OF CATALOG

This catalog is a supplement to Catalog No. 103 S, Style 39500 A, and should be used in conjunction. Parts illustrated in this catalog represent parts not used in 39500 A, B, P or AF machines. For clarity, certain 39500 A, B, P and AF parts are shown in phantom to help locate 39500 AB, AC-045 and AE parts.

Opposite the illustration page, parts are identified by detail number, part number, description, and amount required.

Adjusting and operating instructions included represent only areas concerned with 39500 AB, AC-045 and AE.

This catalog applies specifically to the standard Styles of machine as listed herein and can also be applied with discretion to some Special machines of Class 39500. References to direction, such as right, left, front, back, etc., are taken from the operator's position while seated at the machine. Operating direction of handwheel is away from operator.

STYLES OF MACHINES

Two Needle, One Looper, One Spreader, Three Thread, Low Throw Overseaming Machine. Differential Feed, Trimming Mechanism with Spring Pressed Lower Knife, Automatic Lubricating System.

39500 AB For closing women's seamless nylon hosiery. Seam specification, Special SSa-1; standard seam width is approximately $3/32$ inch. Machine equipped with main feed driving eccentric No. 39540-100 and differential feed driving eccentric No. 39540-70. Stitch range 20 to 100 per inch; standard setting 80 per inch.

39500 AC-045 For closing men's hosiery. Seam specification, Special SSa-1; standard seam width approximately $1/8$ inch. Machine equipped with main feed driving eccentric No. 39540-60 and differential feed driving eccentric No. 39540-30. Stitch range 20 to 100 per inch; standard setting 35 per inch.

39500 AE For closing women's seamless hosiery. Prepared for Paramount Paramount Attachment. Seam specification, Special SSa-1; standard seam width is approximately $3/32$ inch. Machine equipped with main feed driving eccentric No. 39540-70 and differential feed driving eccentric No. 39540-70. Stitch range 20 to 100 per inch; standard setting 70 per inch.

OILING

CAUTION! Oil was drained from machine when shipped, so reservoir must be filled before beginning to operate. Oil capacity of Class 39500 is six ounces. A straight mineral oil of a Saybolt viscosity of 90 to 125 seconds at 100° Fahrenheit should be used.

Machine is filled with oil at spring cap in top cover. Oil level is checked at the sight gauge on front of machine. Red bulb on the oil level indicator should show between gauge lines.

OILING (Continued)

Machine is automatically lubricated. No oiling is necessary, other than keeping main reservoir filled. Check oil daily before the morning start. Add oil as required.

Drain plug screw is located at back of machine near bottom edge of base. It is a magnetic screw, designed to accumulate possible foreign materials which may have entered the crankcase. It should be removed and cleaned periodically.

NEEDLES

Each Union Special needle has both a type and size number. The type number denotes the kind of shank, point, length, groove, finish and other details. The size number, stamped on the needle shank, denotes largest diameter of blade, measured in thousandths of an inch, midway between shank and eye. Collectively, type and size number represent the complete symbol which is given on the label of all needles packaged and sold by Union Special.

39500 AB, AC and AE use a curved blade needle. The standard needle for these styles is Type 154 GCS. It is a slatted shank, round point, .046 inch double slab, standard length, curved blade, double groove, struck groove, spotted, chromium plated needle in sizes 022, 025, 027, 029, 032, 040.

To have needle orders promptly and accurately filled, an empty package, a sample needle, or the type and size number should be forwarded. Use description on label. A complete order would read: "1000 Needles, Type 154 GCS, Size 025".

Selection of proper needle size is determined by the size of thread used. Thread should pass freely through the needle eye in order to produce a good stitch formation.

Success in the operation of Union Special machines can be secured only by use of needles packaged under our brand name, *Union Special*, which is backed by a reputation for producing highest quality needles in materials and workmanship for more than three-quarters of a century.

CHANGING NEEDLES

Release pressure on presser foot by turning presser foot release bushing (N, Figs. 1 and 2) and swing presser arm (E) out of position. Turn handwheel in the operating direction until needles are at their lowest point of travel. Using hexagonal socket wrench No. 21388 AU, furnished with machine, loosen needle clamp nut about 1/4 turn. Again turn handwheel until needles are at high position. Withdraw needles.

To replace needles, leave needle holder at high position and, with the flats to the left, insert needles in holder until they rest against the stop pin. Keeping needles in this position, turn handwheel until holder is again at its low point of travel, then tighten nut. Return presser arm (E) to position; relock presser foot bushing (N).

THREAD STAND

39500 AC ONLY

After thread comes from thread cones (positioned on cone support (P)), it is brought up through BACK thread eyelet, then down through FRONT thread eyelet (R, Fig. 1). Next, thread is extended down through the right hand hole and up through left hand hole of the tension thread guide wire (A). Thread is then continued between tension discs (W), through slot (V), and on through thread guide (B).

39500 AB AND 39500 AE ONLY

After thread comes from cones (positioned on cone support (P)), it is brought up through the BACK thread eyelet, then continues between felt pads (X) through slot (V), and down through FRONT thread eyelet (R, Fig. 2). Next, thread is extended down through the left hand hole in the tension thread guide wire (A), through holes in the thread guide (B).

THREADING

Only parts involved in threading are shown in threading diagrams (Figs. 1 and 2). Parts are presented in their relative positions for clarity.

The following recommended procedure simplifies threading: Beginning with complete threading of upper looper, progress to complete threading of right needle, and conclude by complete threading for left needle. Steps for threading are given below.

Prior to threading, swing cloth plate open, turn handwheel in operating position to bring needles (M) into high position. Release pressure on presser foot by a counterclockwise turn of the release bushing (N), and then swing presser arm (E) out of position.

CAUTION! Make sure the threads, as they extend from the tension thread guide wire (A, Figs. 1 and 2), are between tension discs (W) and in diagonal slots (V) of the tension posts (U).

TO THREAD UPPER LOOPER

Turn handwheel until point of upper looper (L) is all the way left. Lead thread through auxiliary looper thread eyelet (C) from back to front, then through both eyes of upper looper thread eyelet (D) from left to right. **NOTE:** Thread must pass in front of looper thread pull-off (F). After pulling up upper looper thread tube assembly (K), lead the thread under neck of top cover casting and down through thread tube assembly (K). This is easily accomplished by using the forked end of the threading wire, supplied with each machine. Pull thread out bottom of tube using hooked end of tweezers, also supplied with each machine. Push tube down, and then insert thread through upper looper eye from front to back.

CAUTION! Be sure upper looper thread is under the needle threads when passing from tube assembly to upper looper eye.

TO THREAD NEEDLES

Turn handwheel in operating direction until needles (M) are at their highest position. Insert both needle threads from right to left, through BOTH eyes of needle thread eyelet (H), under neck of top cover casting and then down through holes in top cover needle thread eyelet (J). The right needle thread should be threaded in the right hole and the left needle thread through the left hole of the top cover needle thread eyelet. Thread needles from the front.

THREAD TENSION

The amount of tension on the needle and looper threads is regulated by three knurled tension nuts (S, Figs. 1 and 2). Tension on threads should be only sufficient to secure proper stitch formation.

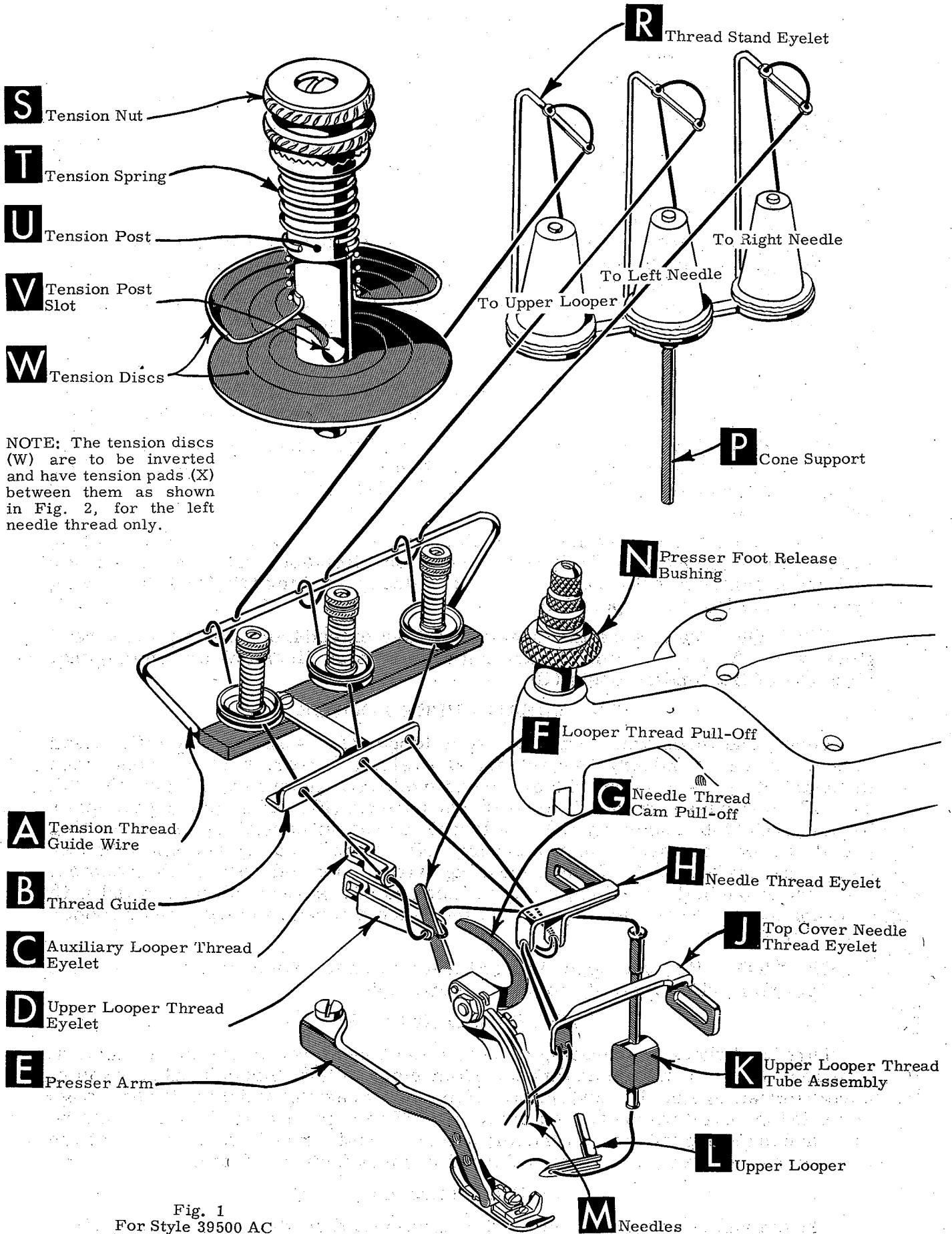

Fig. 1
For Style 39500 AC

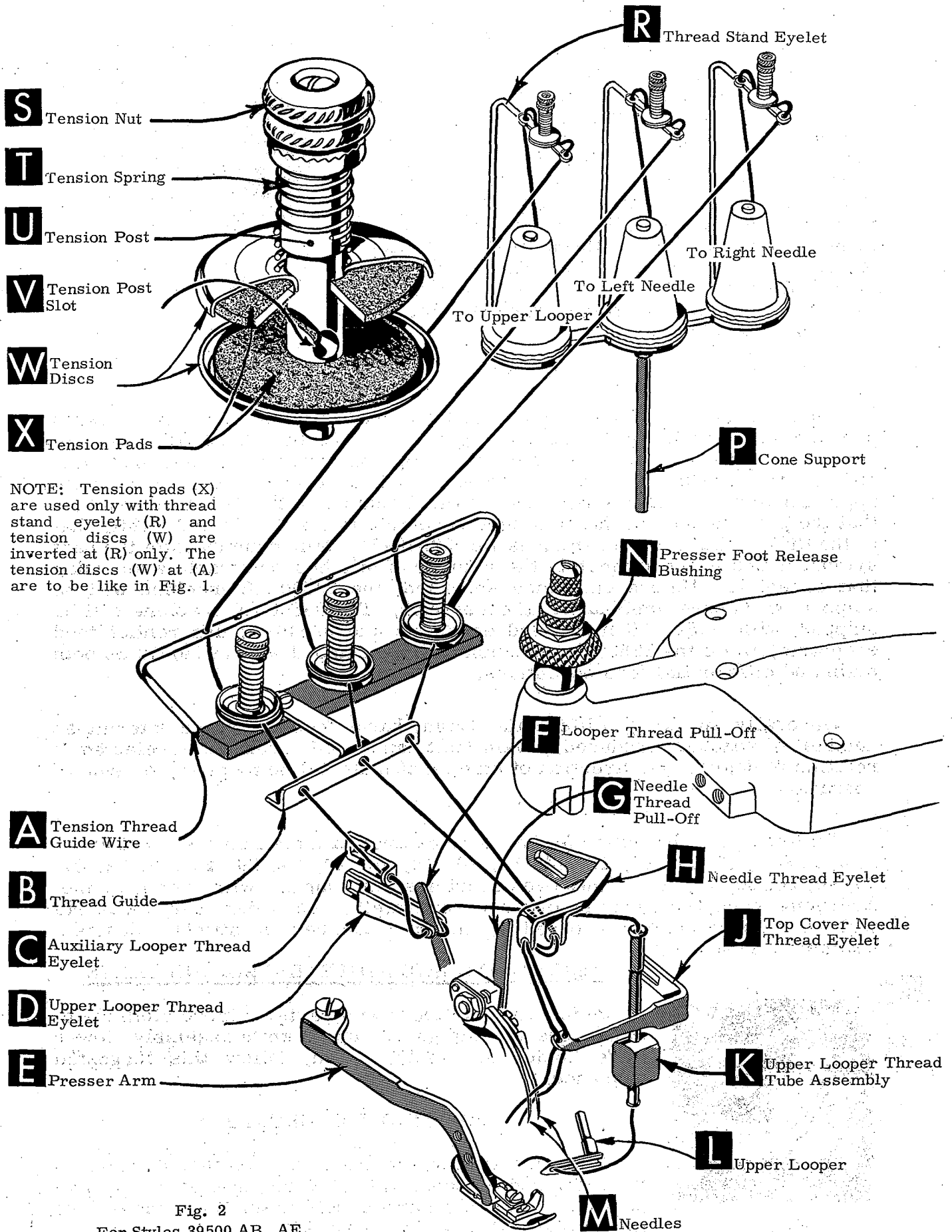

Fig. 2
For Styles 39500 AB, AE

PRESSER FOOT PRESSURE

Sufficient pressure to feed the work uniformly should be maintained. Should it be necessary to increase or decrease amount of pressure on presser foot, loosen lock nut (A, Fig. 3), and turn adjusting screw (B). Adjusting screw has a right hand thread; tightening will increase pressure, loosening decreases the pressure. When pressure adjusting screw (B) has been properly set, tighten the lock nut (A). With presser foot resting on throat plate, position locking nut (C) so that its under surface is approximately 1/32 inch to 1/16 inch from the top surface of the adjusting screw (B). Set cap (D) against locking nut (C).

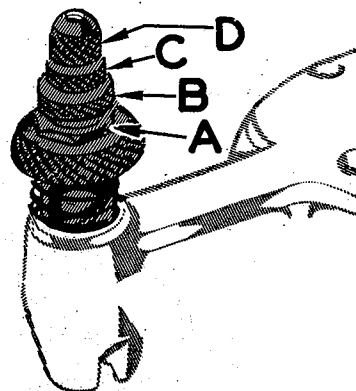

Fig. 3

FEED ECCENTRICS

Feed eccentrics used in the 39500 AB machine have been selected to produce approximately 80 stitches per inch. On the 39500 AC machine, eccentrics have been selected to produce approximately 35 stitches per inch, and on the 39500 AE machine, eccentrics have been selected to produce approximately 70 stitches per inch. It will be noted on the 39500 AB machine that the part number of the main feed eccentric is No. 39540-100, while that of the differential feed eccentric is No. 39540-70. Minor numbers of the part symbol indicate approximately the number of stitches obtainable when using that eccentric. Unless otherwise specified, the 39500 AB machine will be shipped with above combination of eccentrics. The 39500 AC machine will be shipped with 39540-60 main feed eccentric and 39540-30 differential feed eccentric, while the 39500 AE machine will be shipped with 39540-70 as both main and differential feed eccentrics.

Generally speaking, differential (right hand) feed eccentric determines number of stitches produced. Main (left hand) feed eccentric is selected in relation to degree and direction of stretch of material being sewn, or type of operation.

Following stitch number feed eccentrics are available under No. 39540- 4, 5, 6, 7, 8, 9, 10, 11, 12, 13, 14, 15, 16, 18, 20, 22, 24, 26, 28, 30, 32, 34, 36, 40, 50, 60, 70, 100. Only two eccentrics are supplied with each machine. Additional eccentrics may be ordered separately. To order, use No. 39540 with a minor number suffixed to indicate number of stitches desired. Example: 39540-70.

ASSEMBLING AND ADJUSTING SEWING PARTS

Before assembling sewing parts, remove cloth plate, fabric guard, chip guard, upper knife assembly, lower knife holder assembly. Then, follow this suggested sequence:

SETTING THE NEEDLE

With throat plate in position, needles should center in the front end of needle slot. When needles are at high position, the needle points should be set 15/32 inch above throat plate (Fig. 4) for 39500 AC.

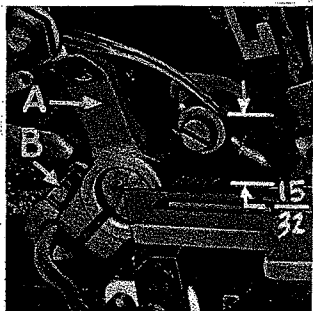

Fig. 4

SETTING THE NEEDLE (Continued)

For 39500 AB, 39500 AE the needle points should be set $7/16$ inch above the throat plate. Move needle driving arm (A, Fig. 4) by loosening clamp screw (B). Remove throat plate.

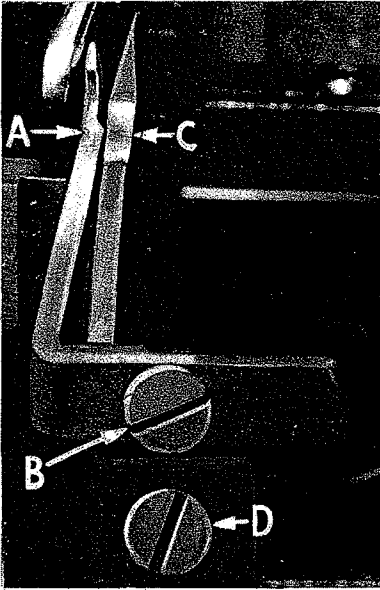

Fig. 6

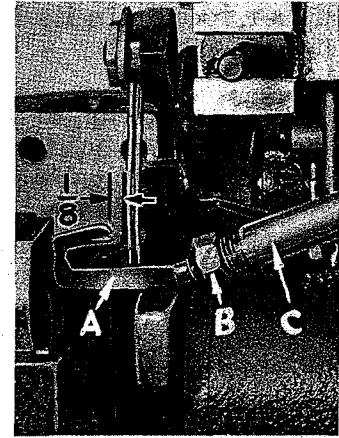

Fig. 5

At this point, insert lower spreader (A, Fig. 5) into bar (C). With lower spreader at the left end of its stroke, set the spreader point $1/8$ inch from center of left needle, using looper gauge No. 21225 G- $1/8$. Do not have lower spreader deflecting the needles. Tighten nut (B).

SETTING THE REAR NEEDLE GUARD

Set rear needle guard as high as possible (A, Fig. 6) without interfering with either lower spreader or movement of lower knife holder, but still in position to deflect needle forward, .002 to .004 inch. Screw (B) is used to set the rear needle guard. Make sure there is no interference between the rear needle guard and lower spreader.

SETTING THE LOWER SPREADER

Now, finish lower spreader adjustment. As spreader moves to the right, its point should be set into the needle scarfs (A, Fig. 7) until needles spring forward from rear guard surface another .002 to .004 inch.

SETTING THE FRONT NEEDLE GUARD

Assemble front needle guard (C, Fig. 6). When lower spreader is springing needle off back guard, set the front needle guard as close as possible to needles without touching. Screw (D) is used to adjust and set front needle guard. After this setting, make sure there is no interference between the needle guards and differential feed dog.

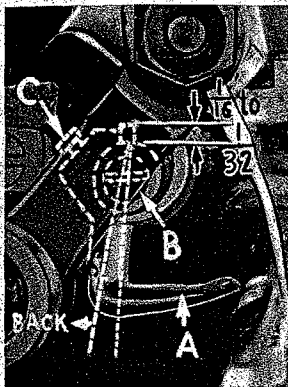

Fig. 8

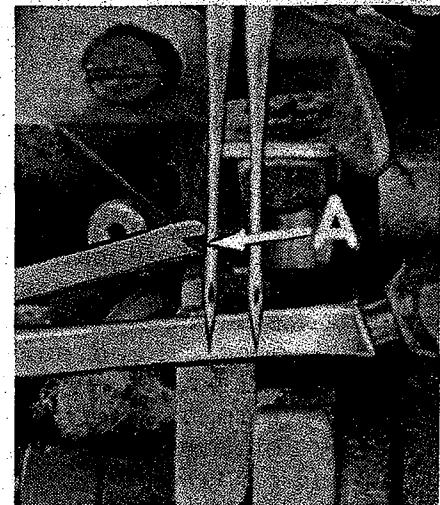

Fig. 7

SETTING THE UPPER LOOPER

Insert upper looper (A, Fig. 8) in its holder. Screw (B) holds upper looper in its holder and permits it to be pushed in or out or turned around its shank. Insert upper looper holder into upper looper shaft (if not already in place).

SETTING THE UPPER LOOPER (Continued)

Screw (C) on the clamp holds the upper looper holder in the shaft. Locate upper looper in its holder so that the shank extends $1/32$ to $1/16$ inch beyond holder (Fig. 8).

When the upper looper is at the right end of its stroke, upper looper holder should be set to position upper looper shank back of vertical.

Next, turn the handwheel until looper is at the left end of its travel. Check the dimensions of the upper looper point with respect to needle and throat plate (Fig. 9) and the following dimensions; distance from centerline of left needle to point of looper should be approximately $5/32$ inch and distance from throat plate to point of looper should be approximately $15/32$ inch on 39500 AC machine.

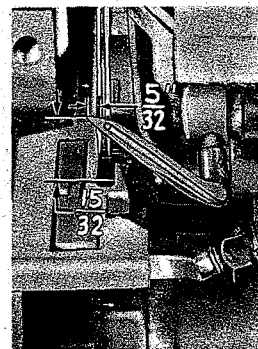

Fig. 9

NOTE: For Styles 39500 AB, 39500 AE, the dimensional setting of the upper looper point with respect to throat plate is approximately $7/16$ inch. If resetting is necessary, do so by moving the upper looper holder (A, Fig. 9).

When the correct setting is obtained, it can be checked quickly as follows: As upper looper is moving to the right, when upper looper eye centers on the right needle, the eyes of the upper looper and right needle should align (Fig. 10).

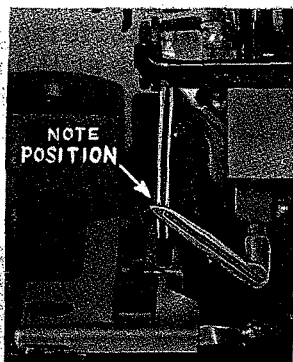

Fig. 10

Check setting to avoid interference between upper looper and needles on needle down stroke. If needles rub the back of upper looper, pull looper out of its holder slightly and rotate a short distance counterclockwise, looking from left end of machine. Reset to maintain dimensions suggested above and in Figs. 9 and 10.

SETTING THE FEED DOGS

Assemble and set the differential feed dog (A, Fig. 11) and main feed dog (B) so that top surfaces of the feeding surfaces all lay in the same plane. This can be checked by sighting across feeding surface with a straight edge. Feed surfaces should now be leveled with the throat plate surfaces by rotating feed tilting adjusting pin (D). This pin raises or lowers the back end of both feed bars at the same time.

The feeding surfaces should be set level at the time feeding surface first appears above the throat plate. Screw (E) locks feed tilting adjusting pin in place.

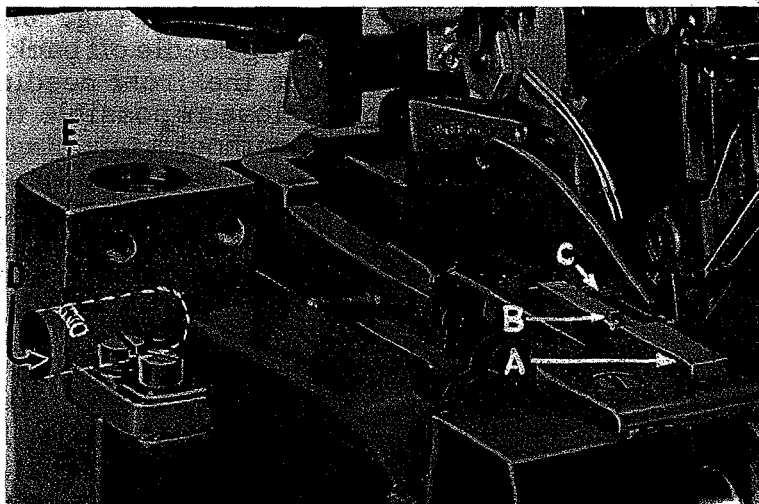

Fig. 11

SETTING THE FEED DOGS (Continued)

Now, set feeding surfaces so they rise about $3/64$ inch above throat plate.

Set chaining feed dog (C) level with top of throat plate when feed dog is at top of its travel.

SETTING THE LOWER KNIFE

Replace lower knife holder assembly. Lower knife (A, Fig. 12) should be set with cutting edge flush with throat plate surface. Adjustments are made with hexagonal head screw which holds lower knife. Lower knife is spring pressed against upper knife, so no lateral adjustment is necessary when width of trim is changed.

Lower knife may be secured in any position by tightening screw (B) and locking nut (C) against support bracket. Because screw (B) also serves as latch pin for the cloth plate latch spring, it should always be locked with nut (C) even when screw is not tightened against lower knife holder.

SETTING THE UPPER KNIFE

Replace upper knife assembly. Clamp upper knife (D, Fig. 12) in position, setting nut (E) to hold clamp (F) in its most clockwise position against upper knife. At bottom of its stroke, front cutting edge of upper knife should extend not less than $1/64$ inch below cutting edge of lower knife. The chain guard (J) should be set down against the upper knife and slightly back from the cutting edge.

After upper knife has been set for proper width of trim, screw (G) should be tightened to lock upper knife holding block (H) in place. This will simplify resetting when upper knife is replaced.

SETTING THE STITCH LENGTH

Length of stitch is determined by the combination of feed eccentrics used. Outer (left) eccentric (A, Fig. 13) actuates main (rear) feed dog; while the inner (right) eccentric (B) actuates the differential (front) feed dog.

In assembling feed eccentrics, be sure hubs are facing each other. Be careful not to damage shaft or key. Tighten nut (C) securely. Be sure wool yarn in oil tube (F) touches feed eccentric connections.

To change feed eccentrics, remove nut (C) from end of shaft (D). Turn handwheel in operating direction until key slot in eccentric is toward front. Using hooked eccentric extractor (E), supplied with machine, reach behind eccentrics as shown and withdraw eccentrics. It may be necessary to move hand wheel back and forth slightly during extraction.

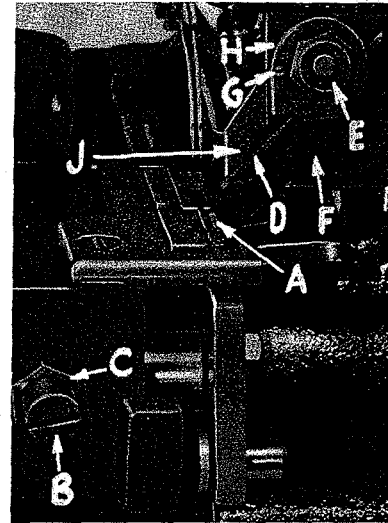

Fig. 12

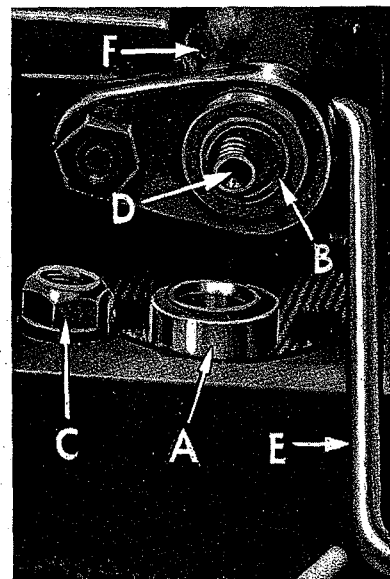

Fig. 13

SETTING THE STITCH LENGTH (Continued)

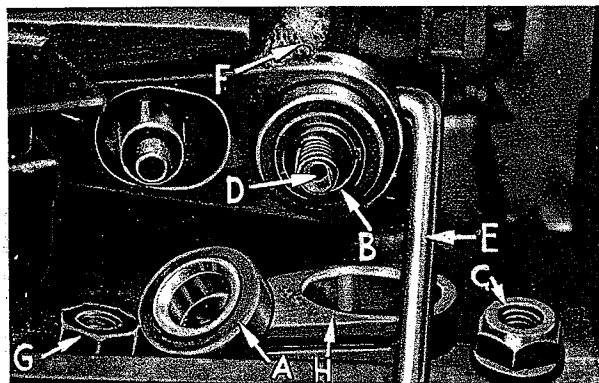

Fig. 14

If eccentrics are unusually tight fitting, in addition to removing nut (C, Fig. 14) from shaft (D), it may be helpful to remove nut (G) and feed driving connection (H). Then continue as originally suggested.

SETTING THE PRESSER FOOT

Assemble presser foot to presser arm. With needle in high position, swing presser arm into sewing position and lock in place. If necessary, presser foot can be realigned with

throat plate slots by shifting foot lifter lever shaft.

Foot lifter lever arm (A, Fig. 15) and collar (B) secure the shaft. Be sure presser arm does not bind and rise when presser foot release bushing is unlocked. To center presser foot and stitch tongue with respect to throat plate needle hole, loosen presser foot hinge screw.

Adjust lifter lever stop screw (C) so that presser foot can be raised no higher than upper looper will permit; then, lock nut (D). To find this maximum safe position, turn the handwheel so point of upper looper is directly over presser foot tongue. Raise presser foot by depressing the presser foot treadle and manually lower the toe of foot. Height adjustment is correct if presser foot tongue does not contact the upper looper. There should be from 1/16 to 1/8 inch free motion of foot lifter lever before presser foot begins to rise. This adjustment is made with screw (E), locked with nut (F).

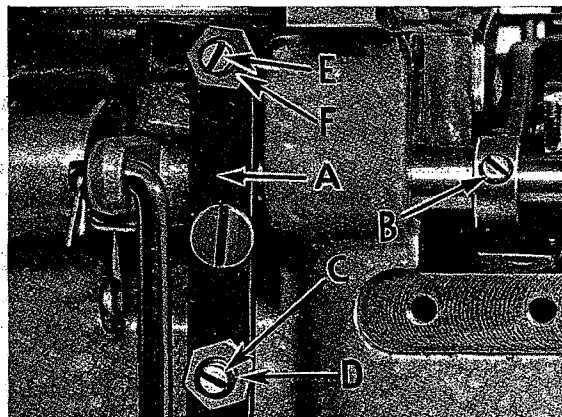

Fig. 15

Finally, re-assemble chip guard, fabric guard, cloth plate.

STARTING TO OPERATE

Be sure machine is threaded according to diagram for your style of machine (either Fig. 1 or Fig. 2). With thread tensions light, set looper thread eyelet (D, Figs. 1 and 2) about horizontal and back in its front to back location. Operate machine slowly, without presser foot in place, to make sure that chain forms and moves off the tongue freely. Swing presser foot into position, insert material, and sew slowly.

NEEDLE THREAD CONTROL

While sewing on material, check needle thread control as follows:

FOR 39500 AC

About 60% of needle thread is drawn from cones on needle down stroke. The remaining 40% is drawn on the upstroke. With needle at bottom of stroke, position needle thread eyelet (H, Fig. 1) so that needle thread cam pull-off (G) just contacts needle thread.

NEEDLE THREAD CONTROL (Continued)

The eyelet is adjusted correctly in its front to back position when the desired stitch is obtained with the least amount of needle thread tension when sewing over the complete speed range.

FOR 39500 AB AND 39500 AE

Usually, all needle thread is drawn on needle down stroke. At top of needle stroke, thread should be just tight enough to feed chain off stitch tongue. Needle threads tend to pull down slightly if excessive thread is pulled on the up stroke. With needles at bottom of stroke, position needle thread pull-off eyelet (H, Fig. 2) so that the needle thread pull-off (G) draws the proper amount of needle thread to satisfy the above conditions.

UPPER LOOPER THREAD CONTROL

During needle down stroke, forward stroke of looper thread pull-off (F, Fig. 1 or Fig. 2) will draw upper looper thread through the tension. When normal amount of looper thread is drawn, upper looper thread will have almost all slack taken up as looper thread pull-off reaches its most rearward position.

FOR 39500 AC

If upper looper thread has a loose appearance in the seam, move looper thread pull-off eyelet (D, Fig. 1) forward and raise slightly. If, however, the eyelet is raised too high and moved too far forward, the looper thread will tend to break excessively--even with a minimum amount of looper thread tension applied.

FOR 39500 AB AND 39500 AE

If upper looper thread has loose appearance in the seam, move looper thread pull-off eyelet (D, Fig. 2) forward slightly. If, however, the eyelet is too far forward, the looper thread will tend to break excessively--even with a minimum amount of looper thread tension applied.

CAUTION! Do not try to obtain a tight looper thread appearance on the seam by carrying high tensions.

POSITIONING THE PURL TO OBTAIN A FLAT SEAM

If the purl is at the top edge of the garment, the seam can be opened into a near butted appearance. If, however, the purl is under the edge, a less flat and tighter seam results when opened.

FOR 39500 AC

Raising and bringing the looper thread pull-off eyelet (D, Fig. 1) forward causes less thread to be pulled from the cones as the looper travels to the top of its stroke and causes the purl to form more on the top of the edge. If the eyelet is raised and brought too far forward, however, the thread becomes too tight, resulting in looper thread breakage. With a reasonable amount of looper thread tension to insure a flexible chain, the looper thread pull-off eyelet should be adjusted to position the purl as desired.

FOR 39500 AB AND 39500 AE

Moving the needle thread pull-off eyelet (H, Fig. 2) back causes less thread to be pulled from the cones as the needles travel to the top of their stroke and causes the purl to form more on the top of the edge. If the eyelet is moved back too far, however, the threads become slack at the top of the stroke and the chain will not feed off the throat plate tongue. With a reasonable minimum needle thread tension to insure uniformity, the needle thread pull-off eyelet should be adjusted to position the purl as desired.

THREAD TENSIONS WITH RESPECT TO STITCH

FOR 39500 AC

The needle thread tension required is a function of needle thread and the material being sewn. In general, upper looper thread tension should be set as high as possible without causing the needle threads to be pulled too far over the top of the seam and low enough to prevent looper thread breakage.

FOR 39500 AB AND 39500 AE

The needle threads and looper thread tensions should be set at a minimum to insure uniformity of stitch. **NOTE:** Tension applied to the threads at the thread stand tension pads (X, Fig. 2) should only be enough to prevent the threads from becoming slack between these tension pads and the tension discs mounted on the machine. All controlling tension settings to insure uniformity of stitch should be obtained by varying the tensions at the tension discs, which are mounted on the machine.

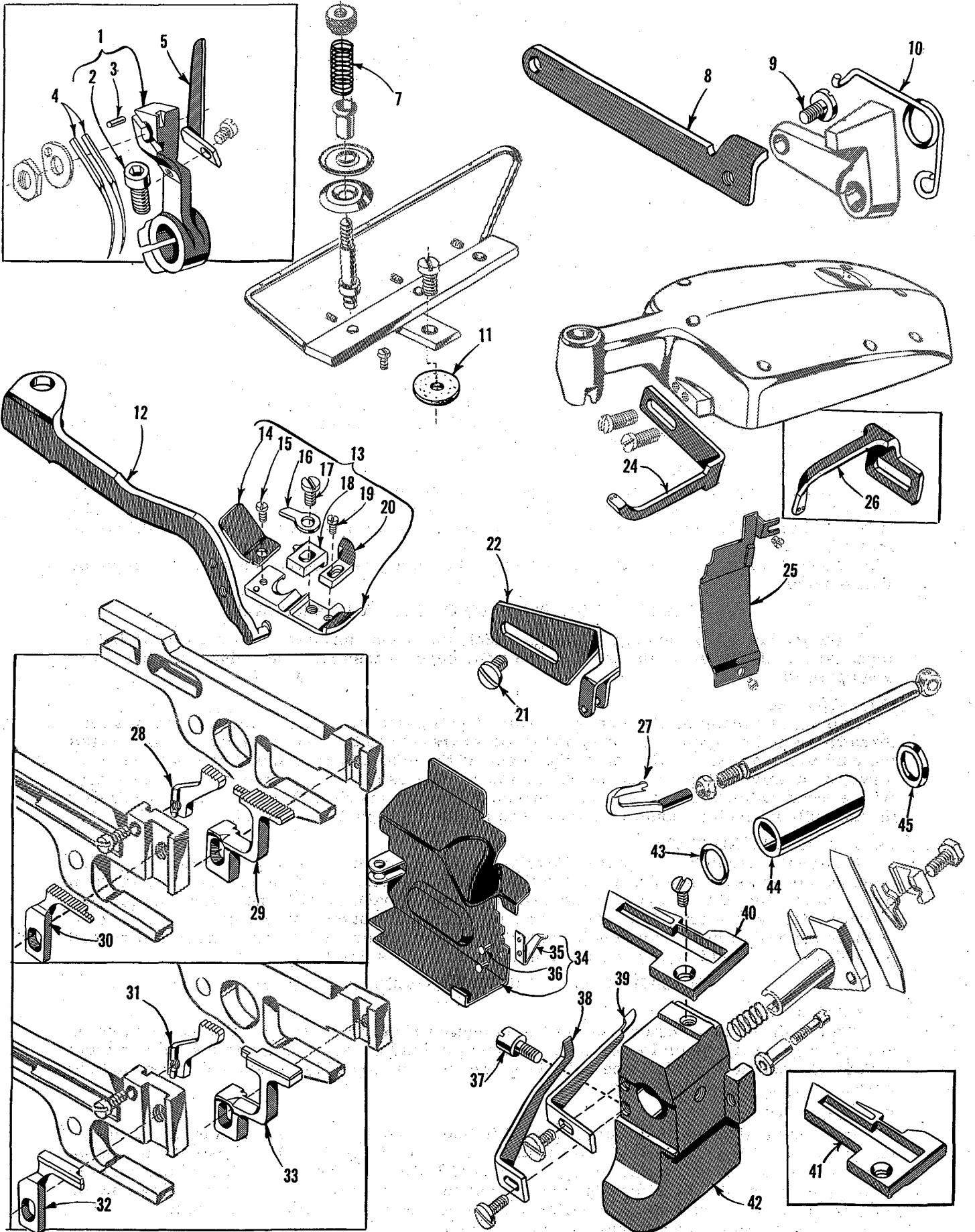

The parts illustrated on the preceding page and described on this page represent the parts used on Styles 39500 AB, AC-045, and AE, but not used on Styles 39500 A, B, P, or AF.

Parts shown in phantom views, bearing no reference numbers, are common to Styles 39500 A, B, P, and AF and 39500 AB, AC-045, and AE.

Use Catalog No. 103 S, Style A, for all parts not illustrated or described here.

Ref. No.	Part No.	Description	Amt. Req.
1	39552 G	Needle Driving Arm, marked "D" -----	1
2	22596 E	Screw -----	1
3	50-774 Blk.	Stop Pin -----	1
4	154 GCS	Needles-----	2
5	39563 P	Needle Thread Pull-off, for Styles 39500 AB, AE -----	1
7	51292 F-1	Looper Thread Tension Spring, for Styles 39500 AB, AE-----	1
	51292 F-1	Needle Thread Tension Spring-----	2
	51292 F-2	Looper Thread Tension Spring, for Style 39500 AC -----	1
8	39555 G	Presser Foot Lifter Extension, for Style 39500 AE -----	1
9	88 D	Screw - Presser Foot Lifter Extension, for Style 39500 AE -----	1
10	39555 H	Presser Foot Lifter Lever Spring, for Style 39500 AE -----	1
11	39592 E	Pad, for 39592 F -----	1
	39592 E	Tension Pad, for Style 39500 AC, left needle thread ----- only: Refer to Fig. 1 -----	2
12	39556 J	Presser Arm-----	1
13	39520 AB	Presser Foot, for Styles 39500 AB, AE-----	1
	39520 AC	Presser Foot, for Style 39500 AC -----	1
14	39530 R	Chain Shield, for presser foot No. 39520 AC-----	1
	39530 S	Chain Shield, for presser foot No. 39520 AB-----	1
15	22738	Screw - Chain Shield-----	1
16	39530 G	Hinge Spring -----	1
17	22768 B	Screw - Tongue and Spring-----	1
18	39597 AB	Presser Foot Stitch Tongue, marked "EK"-----	1
19	22738	Screw - Chip Guard -----	1
20	39530 P	Presser Foot Chip Guard -----	1
21	22569 D	Screw - Needle Thread Eyelet-----	1
22	39563 N	Needle Thread Eyelet, for Styles 39500 AB, AE-----	1
24	39563 X	Top Cover Needle Thread Eyelet, for Styles 39500 AB, AE-----	1
25	39578 BC	Chip Guard, for Styles 39500 AB, AE -----	1
	39578 BB	Chip Guard, for Style 39500 AC -----	1
26	39563 R	Top Cover Needle Thread Eyelet, for Style 39500 AC -----	1
27	39560 B	Lower Spreader -----	1
28	39505 E	Chaining Feed Dog, for Style 39500 AC-----	1
29	39526 AC	Differential Feed Dog, for Style 39500 AC -----	1
30	39505 AC	Main Feed Dog, for Style 39500 AC, marked "AM" -----	1
**31	39505	Chaining Feed Dog, for Styles 39500 AB, AE -----	1
32	39505 AB	Main Feed Dog, for Styles 39500 AB, AE, marked "AG" -----	1
33	39526 AB	Differential Feed Dog, for Styles 39500 AB, AE-----	1
34	39582 GG	Side Cover, for Style 39500 AE-----	1
35	39582 H	Spring -----	1
36	39582 J	Rivet -----	2
37	22585 G	Screw - Side Cover, for Style 39500 AE-----	1
38	39525 H	Needle Guard, front-----	1
39	39525 J	Needle Guard, rear -----	1
40	39524 AB-1/8	Throat Plate, for Styles 39500 AB-1/8, AE-1/8, marked "AX-1/8" -----	1
-	39524 AB-5/32	Throat Plate, for Styles 39500 AB-5/32, AE-5/32, marked "AX-5/32" -----	1
41	39524 AC	Throat Plate, for Style 39500 AC-045, marked "AV" -----	1
-	39528 AC	Throat Plate, for Style 39500 AC-060, marked "AY" -----	1
42	39580 AA	Throat Plate Support Bracket, for Style 39500 AE-----	1
43	660-207	Oil Seal Ring, for needle driving arm crank -----	1
44	39552 N	Bushing, for needle driving arm crank -----	1
45	39552 C	Thrust Washer, for needle driving arm crank-----	1
*	39568 Y	Looper Thread Pull-off Lever-----	1
*	39522 CC	Crankshaft-----	1
*	39590 T	Crankshaft Bushing, inner left -----	1
*	39501 AR	Cloth Plate, for Style 39500 AB; same as 39501 A except nickel plated-----	1

* Not Shown on picture plate.

** Not used on machines having throat No. 39524 AB with long stitch tongue.

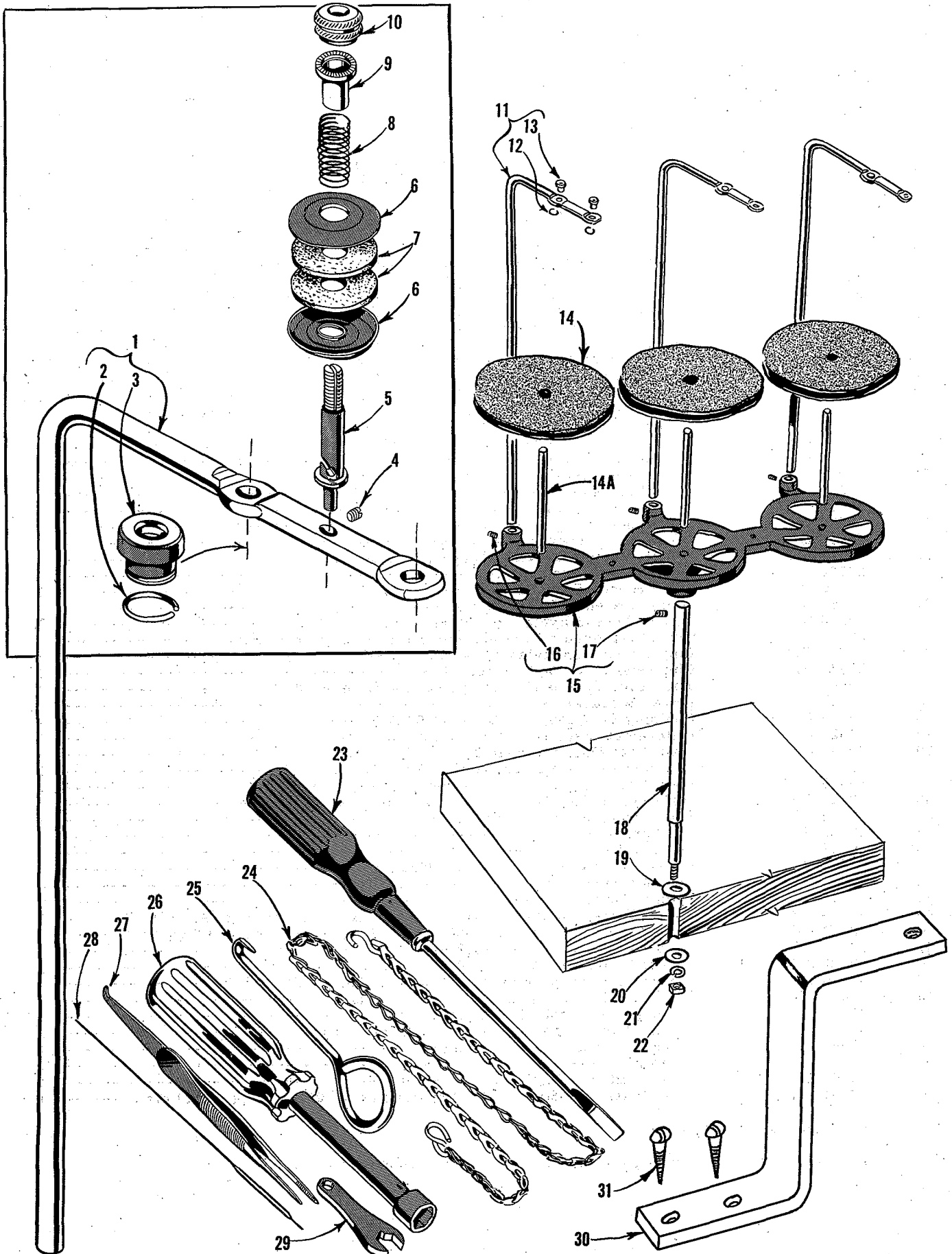

THREAD STAND AND MISCELLANEOUS TOOLS

<u>Ref. No.</u>	<u>Part No.</u>	<u>Description</u>	<u>Amt. Req.</u>
<u>For Styles 39500 AB and AE</u>			
1	21113 G	Thread Stand Eyelet and Support Rod -----	3
2	21114 M	Eyelet Locking Ring -----	6
3	21114 L	Eyelet -----	6
4	22565 C	Screw - Tension Post -----	3
5	39592 D	Tension Post -----	3
6	109	Tension Disc (inverted) -----	6
7	39592 E	Tension Spring Pad -----	6
8	51292 F-1	Tension Spring -----	3
9	107	Tension Post Ferrule -----	3
10	108	Tension Post Nut -----	3
<u>For Style 39500 AC-045</u>			
11	21113 F	Thread Stand Eyelet and Support Rod -----	3
12	21114 M	Eyelet Locking Ring -----	6
13	21114 L	Eyelet -----	6
<u>For Styles 39500 AB, AC and AE</u>			
14	21104 V	Pads -----	3
14A	69 S	Spool Pin -----	3
15	21130 W-3	Cone Support -----	1
16	22650 CB-4	Screw - Thread Stand Eyelet -----	3
17	22650 CE-6	Screw - Thread Stand Rod -----	1
18	21104 AA	Thread Stand Rod -----	1
19	652 J-24	Washer -----	1
20	652 J-16	Washer -----	1
21	WA9 A	Lock Washer -----	1
22	651 A-16	Nut -----	1
*23	21202	Screwdriver -----	1
24	421 D-34	Treadle Chain -----	1
25	21227 BF	Cam Extractor -----	1
26	21388 AU	Socket Wrench, for 3/8 inch nuts holding feed eccentrics -----	1
27	660-240	Thread Tweezers -----	1
28	39599 A	Threading Wire -----	1
29	116	Wrench, for 9/32 inch nuts -----	1
30	39592 J	Tension Post Bracket, for mounting on tableboard -----	1
31	SC333 A	Wood Screw, round head, #9 x 5/8 inch -----	2

* Not furnished with machine.

BOOST PRODUCTION WITH THESE WORK AIDS FROM UNION SPECIAL

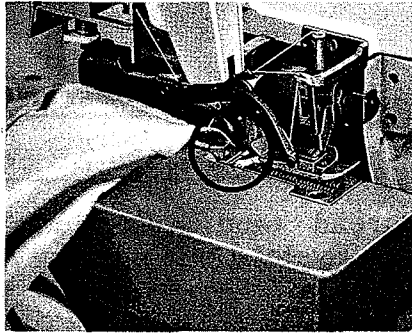

PNEUMATIC CHAIN-CUTTER—for use on conventional Class 39500 and 39600 is a durable scissor-action mechanism that makes a clean positive cut. Style 2899 A-1

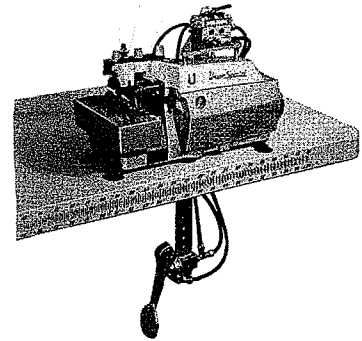

PNEUMATIC FOOT LIFTER—The air-operated foot lifter for use on Class 39500 machines allows the operator to raise the foot simply by knee-touching an actuating switch.

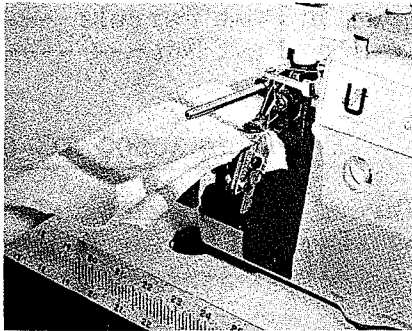

AIR FABRIC UNCURLER—This unit, designed for Class 39500 machines, uses air jets to remove curls from top and bottom plies of flat knit materials as fabric passes through sewing area. Style 2899 B-1

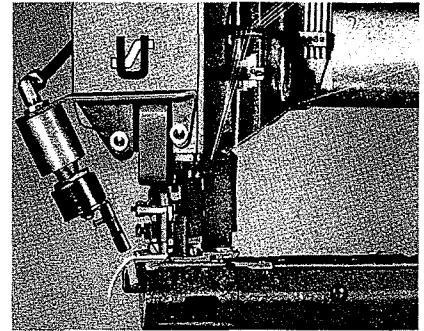

CHAIN CUTTER—The above photo shows the small pneumatic chain cutter that is available for installation as an accessory unit on Class 36200 Flatseamers. Style 2899 A-6

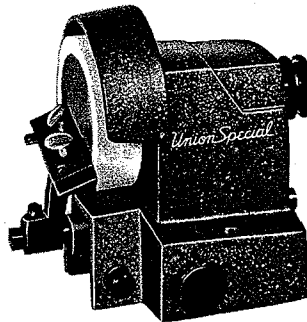
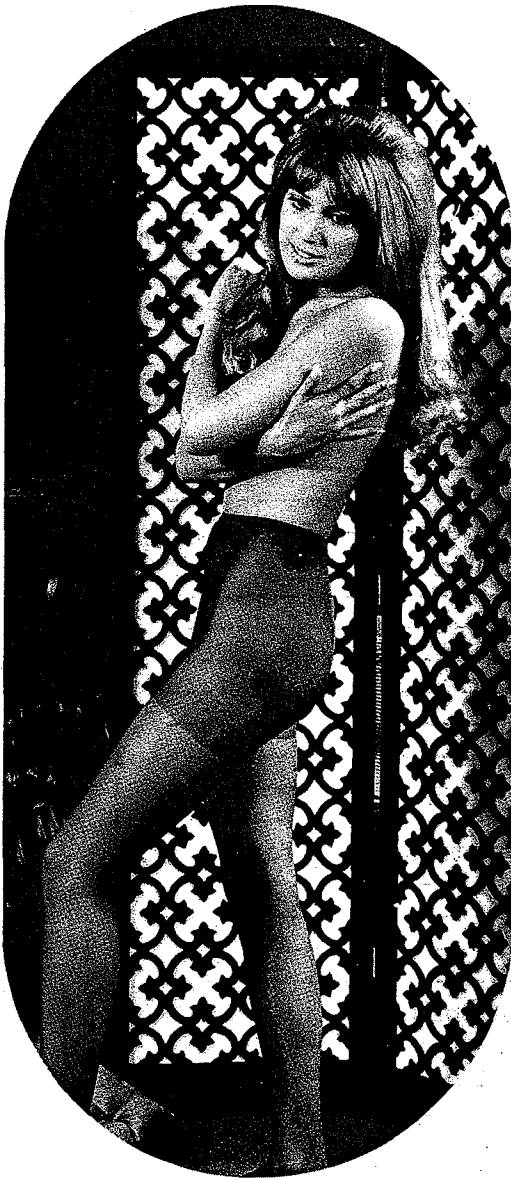

KNIFE GRINDER sharpens straight or angle type knives, is simple and easy to operate, eliminates defective garments caused by dull knives.

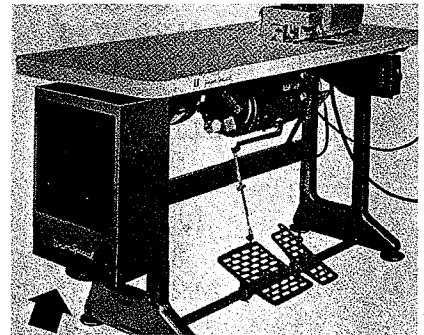

HEAT DISPELLER—Union Special's auxiliary unit (arrow) is an effective means for reducing oil temperature where heavy duty service requires it. Style 2899 E-1

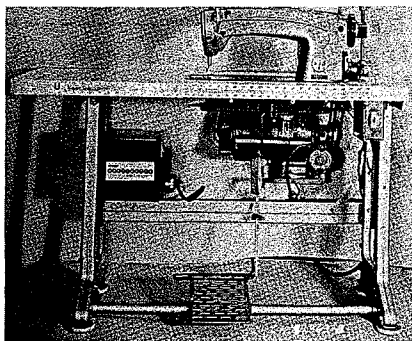

AMCO ELECTRONIC NEEDLE POSITIONERS eliminate the necessity of reaching for the hand-wheel to move the needle up or down . . . this allows the operator to keep both hands on the work, insuring better control, uniform quality and increased production.

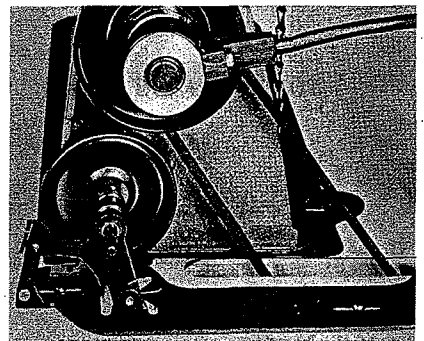

U *Union Special*[®]
FINEST QUALITY
CORPORATION

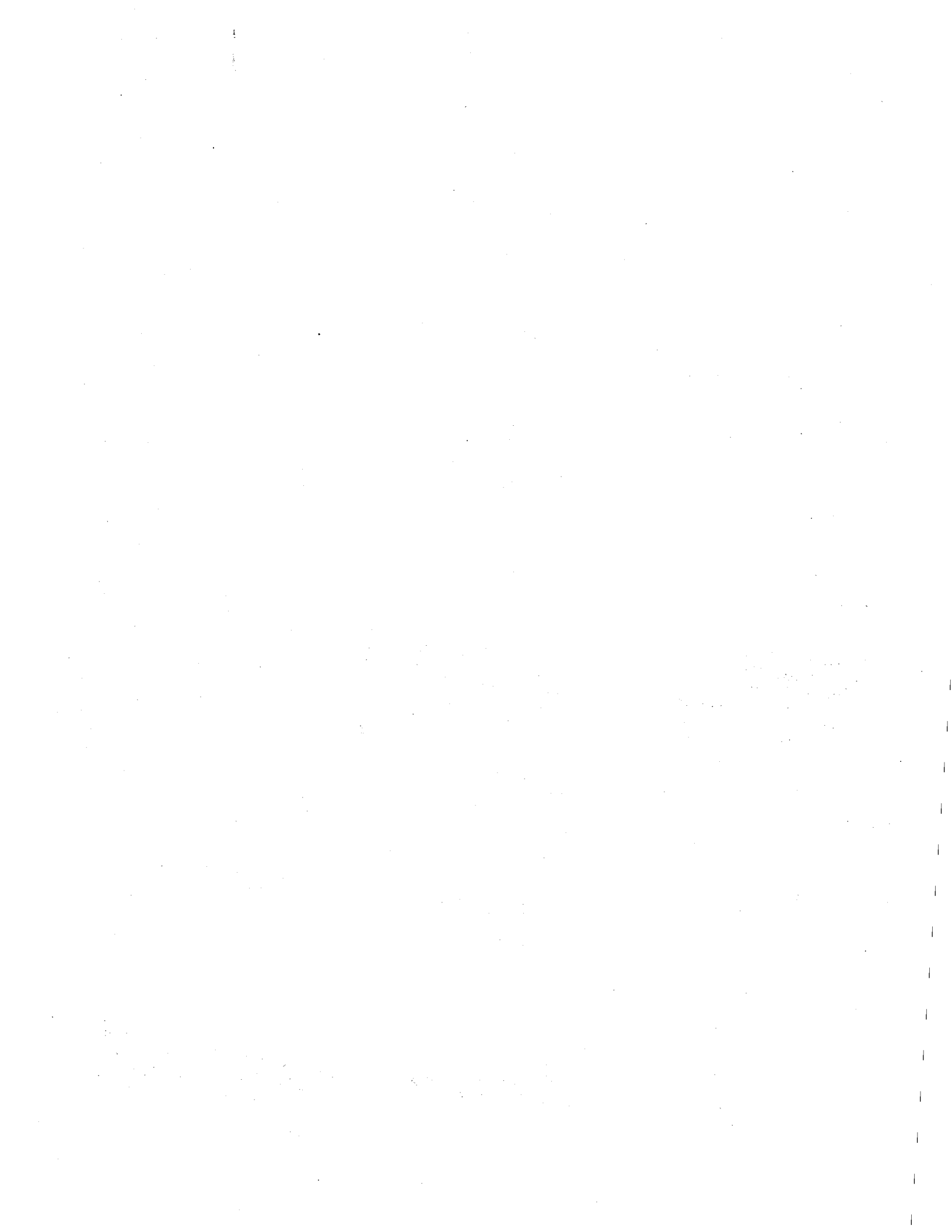

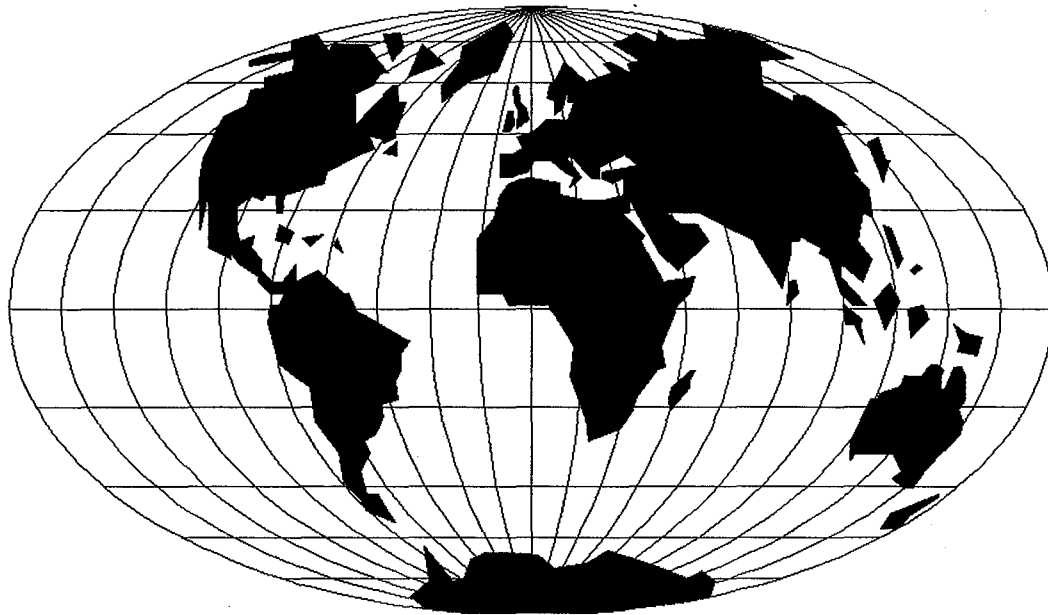

WORLDWIDE SALES AND SERVICE

Union Special Corporation maintains sales and service facilities throughout the world. These offices will aid you in the selection of the right sewing equipment for your particular operation. Union Special Corporation representatives and service technicians are factory trained and are able to serve your needs promptly and efficiently. Whatever your location, there is a qualified representative to serve you.

Corporate Office: One Union Special Plaza
Huntley, IL 60142
Phone: 847•669•5101
Fax: 847•669•1096

European Distribution Center: Union Special GmbH
Raiffeisenstrasse 3
D-71696 Möglingen, Germany
Tel: 49•07141•247•0
Fax: 49•7141•247•100

Brussels, Belgium
Charlotte, N.C.
El Paso, TX
Hong Kong, China
Huntley, IL
Leicester, England
Lille, France
Miami, FL
Milan, Italy
Möglingen, Germany
Montreal, Quebec
Osaka, Japan
Santa Fe Springs, CA

Other Representatives throughout
all parts of the world.



Union Special
INDUSTRIAL SEWING EQUIPMENT