



Union Special
INDUSTRIAL SEWING EQUIPMENT

STYLES

**ADJUSTING INSTRUCTIONS AND
ILLUSTRATED PARTS LIST**

39100

39200

39300

**FLAT BED SINGLE NEEDLE HEAVY DUTY
OVERSEAMING MACHINES WITH TRIMMER
AND UPPER ROTARY SHAFT**

**CATALOG
NO. 71L**

**SECOND
EDITION**

SECOND EDITION
© 1940

PRINTED 1996 IN USA

INFORMATION SUBJECT TO CHANGE WITHOUT NOTICE

© UNION SPECIAL CORPORATION ALL RIGHTS RESERVED IN ALL COUNTRIES.

FOREWORD

It is our constant aim to furnish carefully prepared information that will enable the customer to secure all possible economies and advantages from the use of UNION SPECIAL machines. On the pages which follow will be found illustrations and descriptions of the parts for styles in Classes 39100, 39200 and 39300.

Additional catalogs containing information relative to these machines, and which will be furnished upon request, are listed below.

Catalog No. 45 N
Form 357

Needle Manual
Engineering Department
Adjusting Instructions.
Specify the style number of
the machine for which the
adjusting instructions are
required.

In all manufacturing centers will be found Union Special representatives, who will cooperate with those who desire in planning and estimating their requirements.

UNION SPECIAL CORPORATION

Engineering Department

IDENTIFICATION OF MACHINES

Each UNION SPECIAL carries a style number which is stamped in the name plate on the machine. Style numbers are classified as standard and special. Those which are standard have one or more letters suffixed, but never contain the letter "Z". Example: 39200 AH. Style numbers which contain the letter "Z" are special. When only minor changes are made in a standard machine a "Z" is merely suffixed to the respective standard style number. Example: 39200 AHZ.

Styles of machines similar in construction are grouped under a class number which differs from the style numbers in that it contains no letters. Example: 39200.

APPLICATION OF CATALOG

This catalog applies only to the standard styles of machines as listed herein. It can also be applied with discretion to the special machines in the "Thirty Nine Thousand Series". The parts listed herein are furnished at list prices for repairs only.

STYLES OF MACHINES IN CLASS 39100

Flat Bed Single Needle Light Duty Overseaming Machines, with Trimmer, Upper Rotary Shaft.

39100 C-3/32 For seaming, without crossing elastic, on flat knit and warp knit fabrics made from rayon; Union Overseaming Stitch Type 504, standard width of seam 3/32 inch, tiltable feed, Type 153 A needle.

39100 C-1/8 For seaming and crossing elastics, on flat knit and warp knit fabrics made from rayon; standard width of seam 1/8 inch, otherwise same as 39100 C-3/32.

39100 M For overedging knitted and woven fabrics; two thread stitch Type 503, width of stitch ranges from 1/8 to 3/16 inch, standard width 1/8 inch, tiltable feed, Type 153 A needle.

39100 N For overedging knitted and woven fabrics; three thread square edge stitch Type 505, width of stitch ranges from 1/8 to 3/16 inch, standard width 5/32 inch, tiltable feed, Type 153 A needle.

39100 S For blind stitch hemming on flat knit and warp knit fabrics made from rayon, glove silk cotton, and wool; two thread stitch Type 503, tiltable feed, standard widths of hem 1/2, 3/4, 7/8 and 1 inch, Type 153 A needle.

39100 V For blind stitch hemming on stockings, two thread stitch Type 503, tiltable feed, Type 153 A needle.

STYLES OF MACHINES IN CLASS 39200

Flat Bed Single Needle Heavy Duty Overseaming Machines,
with Trimmer, Upper Rotary Shaft.

39200 B For seaming dresses and similar garments made from woven fabrics; Union Overseaming Stitch, Type 504, standard width of seam $3/16$ inch, tiltable feed, Type 150 A needle.

39200 C- $1/8$ For seaming and crossing elastic on flat knit and warp knit fabrics made from rayon; Union Overseaming Stitch, Type 504, standard width of seam $1/8$ inch, tiltable feed, Type 150 A needle.

39200 E For seaming all types and weights of flat knit, warp knit, and ribbed knit fabrics made from cotton, wool, rayon and silk; Union Overseaming Stitch Type 504, standard width of seam $1/8$ inch, rear differential feed, Type 150 A needle.

39200 F For seaming garment pockets and similar operations on heavy weight fabrics; Union Overseaming Stitch Type 504, standard width of seam $7/32$ inch, tiltable feed, Type 150 A needle.

39200 G For seaming dresses and similar garments made from woven fabrics; felled seam, Union Overseaming Stitch, Type 504, standard width of seam $1/8$ inch, standard width of bite $3/16$ inch, tiltable feed, Type 150 A needle.

39200 J For serging trousers and similar garments with reinforcements; two thread stitch Type 503, width of stitch ranges from $5/32$ to $3/16$ inch, tiltable feed, Type 150 A needle.

39200 K For overedging bed and crib blankets made from fabrics that do not fray readily; three thread square edge stitch, Type 505, width of stitch ranges from $7/32$ to $1/4$ inch, standard width $1/4$ inch, differential feed, Type 150 A needle.

39200 L For selvaging scallops of residence and store awnings; three thread square edge stitch, Type 505, width of stitch ranges from $7/32$ to $1/4$ inch, standard width $1/4$ inch, tiltable feed, Type 150 A needle.

39200 Q For turned edge scallop and straight overedging, without cord, on rayon bed spreads, bed blankets, towels, and other articles made from fabrics that fray readily; three thread square edge stitch, Type 505, standard trimming line $5/16$ inch to the right of the line of needle punctures, standard width of stitch $3/16$ inch, folder on presser foot, tiltable feed, Type 150 A needle.

STYLES OF MACHINES IN CLASS 39200 (Cont'd)

- 39200 R For hemming light and medium weight woven shirts and similar garments; Union Overseaming Stitch, Type 504, standard trimming line $5/32$ inch to the right of the line of needle punctures, standard width of stitch $3/32$ inch, folder on presser foot, tiltable feed, Type 150 A needle.
- 39200 AA For seaming knitted outerwear made from cotton and wool; two thread stitch, Type 502, standard width of seam $5/32$ inch, standard trimming line ranges from $5/16$ to $5/32$ inch to the right of the line of needle punctures, wrench adjustment front tandem differential feed, Type 150 A needle.
- 39200 AC- $3/32$ For seaming the lighter weights of flat knit, warp knit, and ribbed knit fabrics made from cotton, wool, rayon and silk, Union Overseaming Stitch, Type 504, standard width of seam $3/32$ inch, wrench adjustment front tandem differential feed, Type 150 A needle.
- 39200 AC- $1/8$ Standard width of seam $1/8$ inch; otherwise same as 39200 AC- $3/32$.
- 39200 AD- $3/32$ For seaming the lighter weights of flat knit, warp knit, and ribbed knit fabrics made from cotton, wool, rayon, and silk; two thread stitch, Type 503, standard width of seam $3/32$ inch, wrench adjustment front tandem differential feed, Type 150 A needle.
- 39200 AD- $1/8$ Standard width of seam $1/8$ inch; otherwise same as 39200 AD- $3/32$.
- 39200 AE- $1/8$ For seaming all types and weights of flat knit, warp knit, and ribbed knit fabrics made from cotton, wool, rayon, and silk; Union Overseaming Stitch, Type 504, standard width of seam $1/8$ inch, wrench adjustment front tandem differential feed, Type 150 A needle.
- 39200 AH For seaming knitted outerwear made from cotton, wool, rayon, and silk; Union Overseaming Stitch, Type 504, standard width of seam $5/32$ inch, standard trimming line ranges from $5/16$ to $5/32$ inch to the right of the line of needle punctures, wrench adjustment front tandem differential feed, Type 150 A needle.
- 39200 AJ For seaming, with automatically guided reinforcing tape, knitted outerwear made from cotton, wool, rayon, and silk; Union Overseaming Stitch, Type 504, standard width of seam $5/32$ inch, standard trimming line ranges from $5/16$ to $5/32$ inch to the right of the line of needle punctures, wrench adjustment front tandem differential feed, Type 150 A needle.

STYLES OF MACHINES IN CLASS 39200 (Cont'd)

- 39200 AN For overedging collars and fronts of knitted union suits and shaping ends of the collars; three thread square edge stitch, Type 505, width of stitch ranges from 5/32 to 7/32 inch, standard width 3/16 inch, knee press controlled front tandem differential feed, Type 150 A needle.
- 39200 AQ For seaming and intermittently gathering both plies of fabric on dresses, aprons, smocks, and similar garments made from woven materials, Union Overseaming Stitch, Type 504, standard width of seam 3/16 inch, knee press controlled front tandem differential feed, Type 150 A needle.
- 39200 AR For seaming and intermittently gathering and attaching ruffles on dresses, aprons, smocks, and similar garments made from woven materials; Union Overseaming Stitch, Type 504, standard width of seam 3/16 inch, knee press controlled front tandem differential feed, presser foot provided with a stripper blade and slot to separate the plies of fabric so that only the ply passing next to the feed dog is gathered, Type 150 A needle.
- 39200 AS For blind stitch welting or hemming on flat knit, rib knit, and warp knit fabrics made from rayon, glove silk, cotton or wool; two thread stitch, Type 503, wrench adjustment front tandem differential feed, cantilever throat plate mounting for tubular work and swing out cloth plate for flat work, guides for making 1/2, 3/4, and 7/8 inch welts, Type 150 A needle.
- 39200 AT A general utility, four way combination two thread stitch and three thread stitch machine for seaming and welting all types and weights of flat knit, warp knit and ribbed knit fabrics made from cotton, wool, rayon and silk; two thread seaming spec. 503-SSa-1; three thread seaming spec. 504-SSa-1, standard width of seam 1/8 inch; two thread welting spec. 503-EFc-1, three thread welting spec. 504-EFc-1, guides for making 1/2, 3/4 and 7/8 inch welts, wrench adjustment front tandem differential feed; cantilever throat plate mounting for tubular work and swing out cloth plate for flat work, Type 150 A needle.
- 39200 AU For blind stitch welting or hemming on knitted outerwear and all heavy weight knitted goods; two thread stitch, Type 503, wrench adjustment front tandem differential feed, front and rear throat plate mounting, guides for making 1 and 1 1/4 inch welts, Type 150 A needle.
- 39200 AV Equipped with knee operated retractable folded edge guide to simplify the crossing of seams; otherwise same as 39200 AS.

STYLES OF MACHINES IN CLASS 39200 (Cont'd)

39200 AW A general utility, two way combination three thread stitch machine Types 504 and 505 for seaming and welting all types and weights of flat knit, warp knit and ribbed knit fabrics made from cotton, wool, rayon and silk; three thread seaming spec. 504-SSa-1, standard width of seam $\frac{3}{32}$ inch; three thread welting spec. 505-EFc-1, Fig. 1, wrench adjustment front tandem differential feed; front and rear throat plate mounting, hand operated tension release for changing from stitch Type 504 to 505 and vice versa, Type 150 A needle.

STYLES OF MACHINES IN CLASS 39300

Flat Bed Single Needle Overedging Machines, Upper Rotary Shaft Without Trimmer

39300 A For serging trousers and similar garments; two thread stitch, Type 503, tiltable feed, maximum sewing thickness $\frac{5}{32}$ inch, Type 153 A needle.

39300 B For overedging bands and gauntlets of canvas gloves, mittens, and similar articles; two thread stitch, Type 503, tiltable feed, maximum sewing thickness $\frac{5}{32}$ inch, Type 153 A needle.

NEEDLES

TYPE NUMBERS AND SIZES

Each needle has a type number and size number. The former denotes the kind of shank, point, length, groove, finish, and other details. The latter denotes the largest diameter of the blade, measured in thousandths of an inch midway between the shank and eye, and is stamped in the needle shank. Collectively the type number and size number is the complete symbol.

To have orders promptly and accurately filled, the empty package, a sample needle, or the type and size numbers should be given. See marks on packages. An intelligent order would read as follows "100 Needles Type 150 A Size .036". The type numbers of the needles most commonly used in the styles of machines covered by this catalog are listed below. Set opposite each type number is the description of the needle and sizes available.

Type No.	Description
150 A	Round shank, round point, Class "R", double groove, spotted, long blade, long point, nickel plated- sizes 025, 027, 029, 032, 036, 040, 044, 049, 054
150 H	Same as Type 150 A, except ball point- sizes 029, 032, 036

NEEDLES (Cont'd)

Type No.	Description
150 GA	Same as Type 150 A, except chromium plated- size 044
153 A	Round shank, round point, Class "R", single groove, spotted, long blade, long point, nickel plated- sizes 019, 022, 025, 027, 029, 032, 036, 040, 044

APPLICATION OF TYPE NUMBERS TO MACHINES

The type of needle applicable to each style is listed in the description of each style.

ORDERING REPAIR PARTS

PLATES

Grouped, according to scale, will be found illustrations of parts similar in appearance, and, to some extent, component parts that go in the same subdivisions of the mechanism.

When a given design of part is made in two or more sizes, only one illustration is usually shown. In ordering these pieces, it is necessary that the additional information be furnished as requested under these illustrations.

LIST OF PARTS

Turning from the plates to the list of parts, the description of each part and its principal uses will be found. Always check the symbol against its description before ordering. It is not necessary to furnish the plate number.

When a part is used, or can be used, in all machines covered by this catalog, no specific use is mentioned in the description.

For convenience in ordering, minor parts such as screws, nuts and similar articles are repeated after each major part.

(-) A dash in the "plate number" column of the list of parts indicates the absence of an illustration.

(‡) A double dagger in the "symbol to order by" column indicates that the component parts cannot be furnished separately.

IDENTIFYING PARTS

Where the construction permits, each part is stamped with its part number. Some of the smaller parts are stamped with an identification letter to distinguish them from parts similar in appearance.

All part numbers represent the same part, regardless of the catalog in which they appear.

ORDERING REPAIR PARTS (Continued)

SUPPLIES

All supplies, including taps, reamers, belting, belt hooks, belt fasteners, screwdrivers, wrenches and powdered oil stone will be promptly furnished.

USE GENUINE NEEDLES AND REPAIR PARTS

Success in the operation of these machines can be secured only with genuine UNION SPECIAL Needles and Repair Parts as furnished by the Union Special Corporation, its subsidiaries and authorized distributors. They are designed according to the most approved scientific principles, and are made with utmost precision. Maximum efficiency and durability are assured.

Genuine needles are packaged with labels marked *Union Special*. Genuine repair parts are stamped with a reproduction of the familiar Union Special trademark, U S Emblem. Each trademark is your guarantee of the highest quality in materials and workmanship.

TERMS

Prices are net cash and subject to change without notice. All shipments are forwarded f.o.b. shipping point. Parcel Post shipments are insured unless otherwise directed. A charge is made to cover postage and insurance.

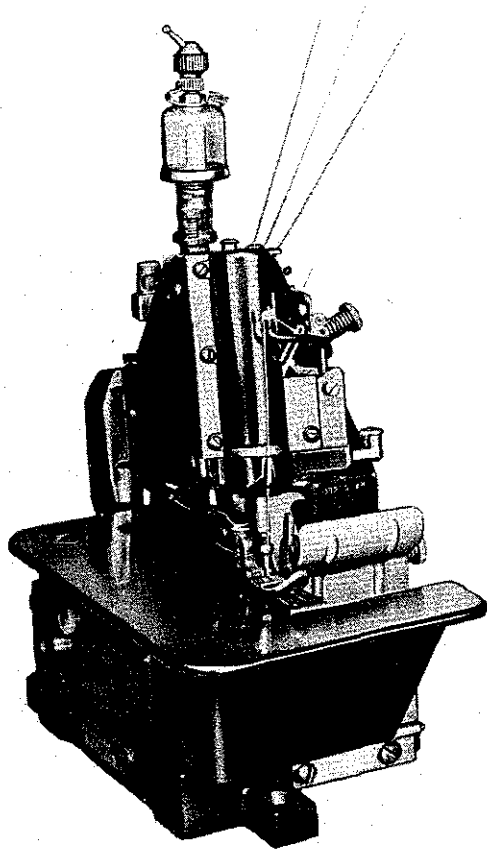

Style 39200 AH

Plate No. 1 - Full Size

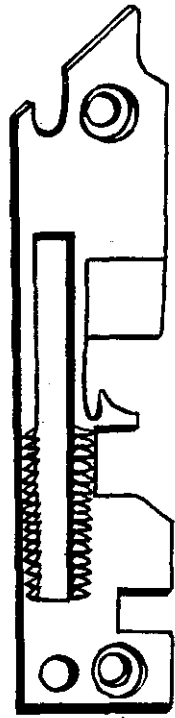

39124T

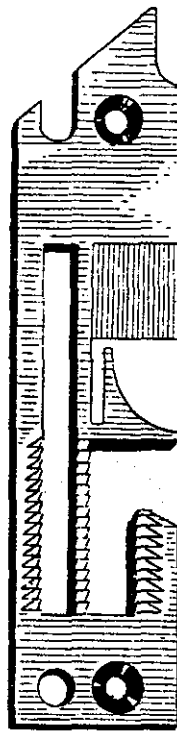

39124D



39124C

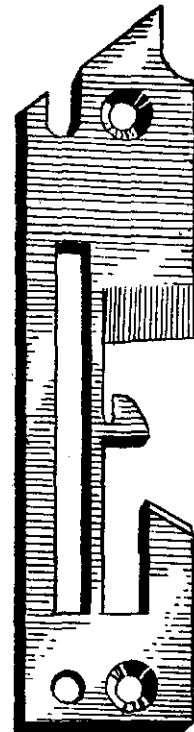

39124P

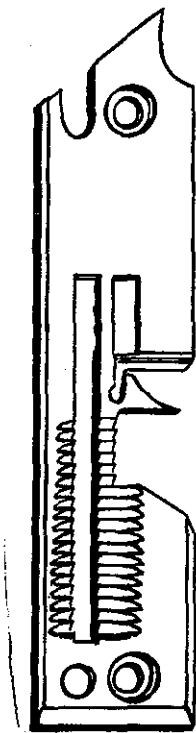

K55505



39124F



39124G

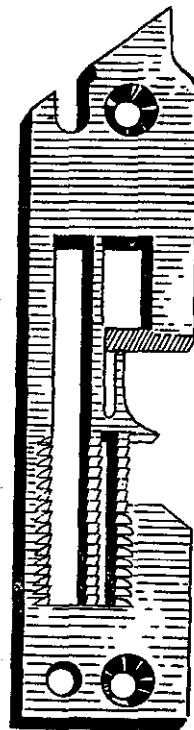

39124R

Plate No. 2 - Full Size

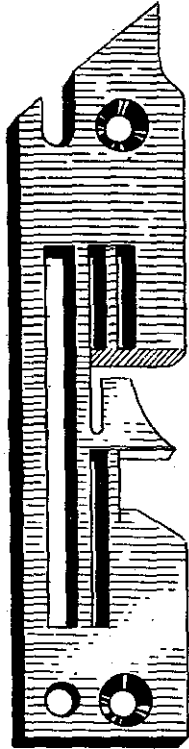

39224A

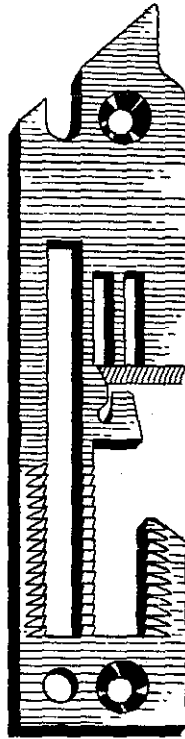

39224B

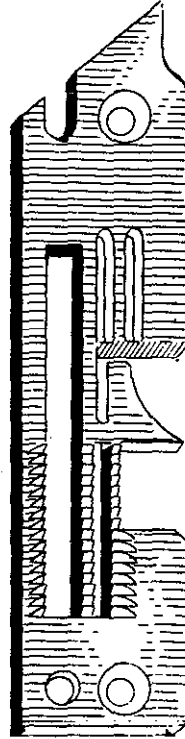

39224J



39324A

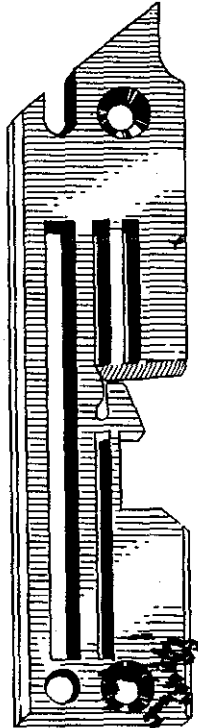

39224AN

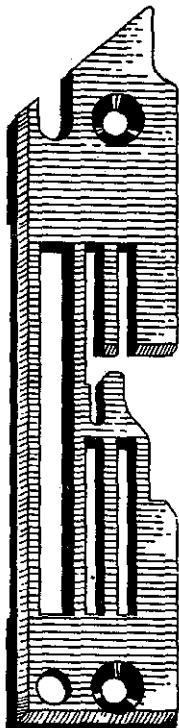

39224Q



39224

Plate No. 3 - Full Size

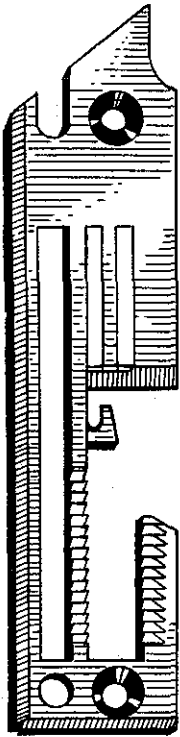

39224AE

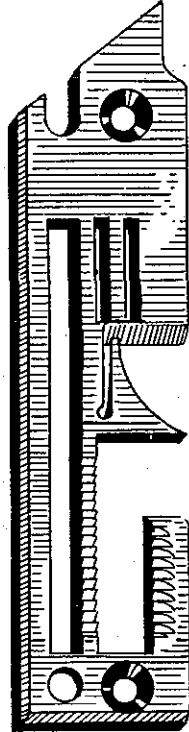

39224AC
Specify
Seam
Width

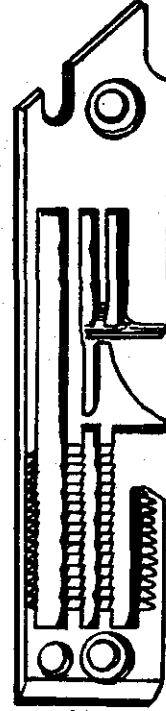

39224AR

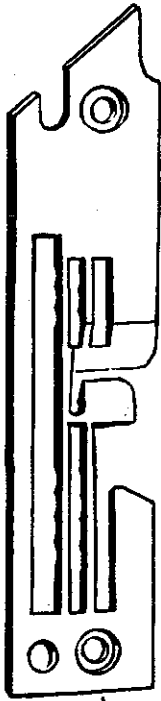

39224K

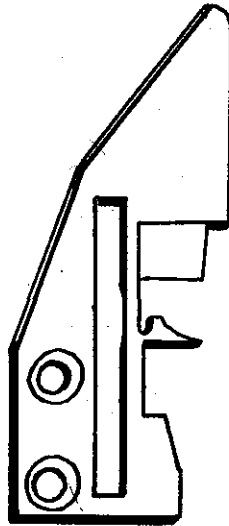

39124V

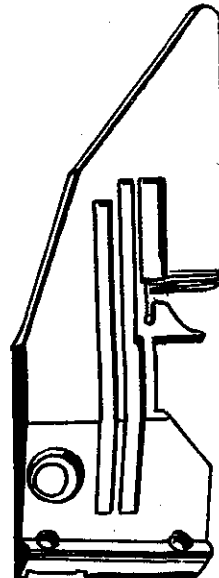

39228AS

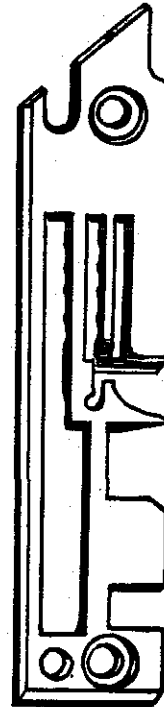

39224AV

Plate No. 4 - Full Size

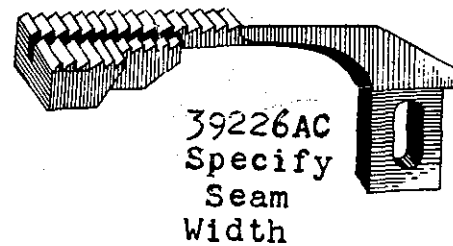
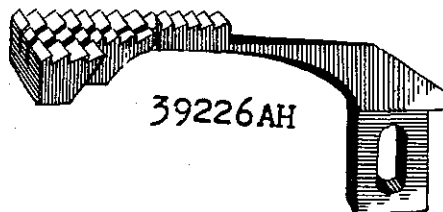
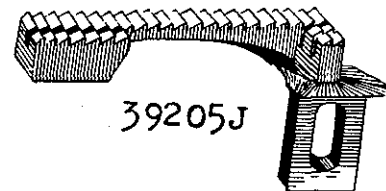
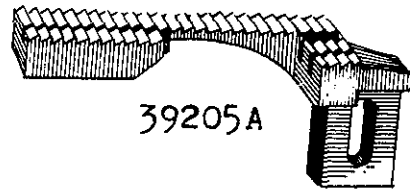
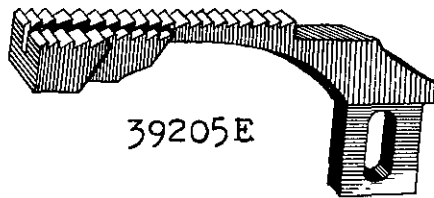
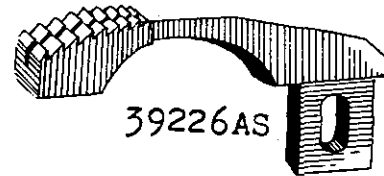
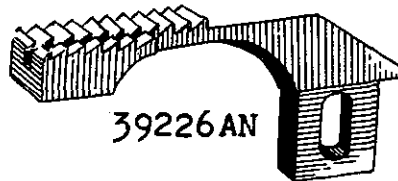
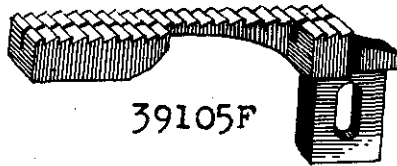
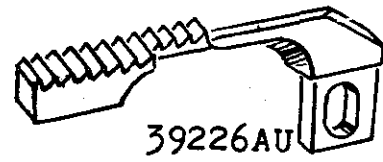
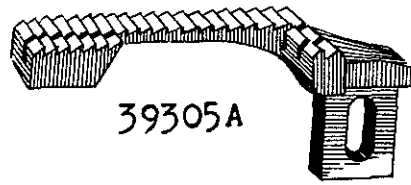

Plate No. 5 - Full Size

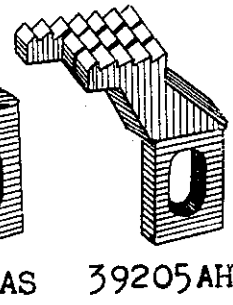
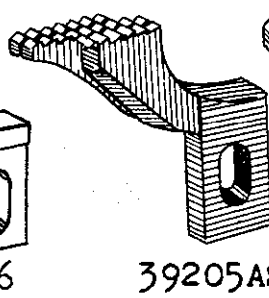
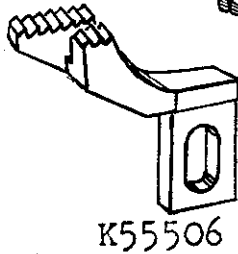
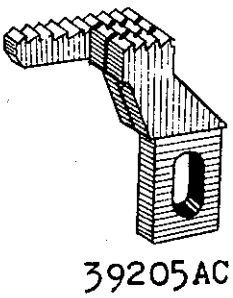
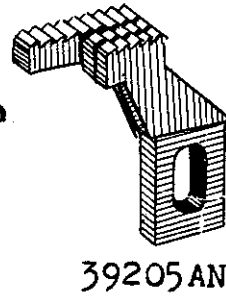
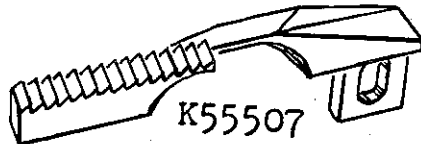
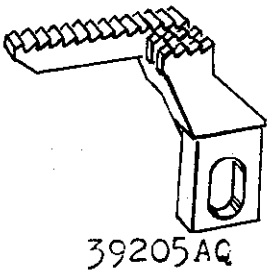
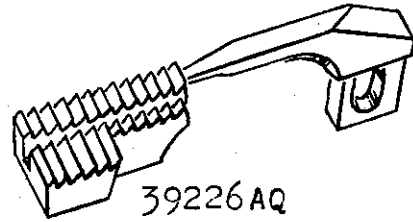
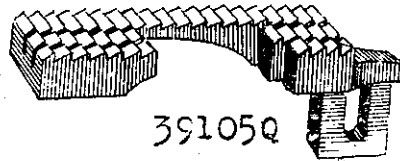
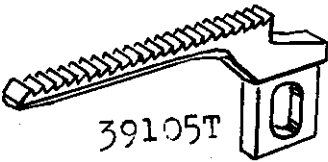
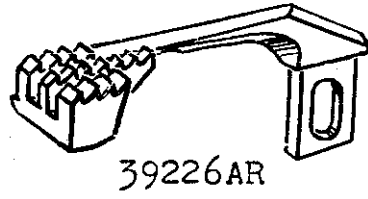
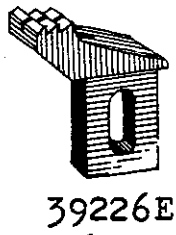
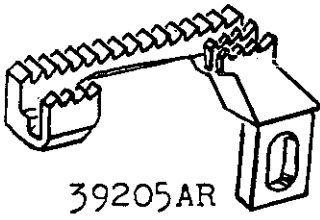
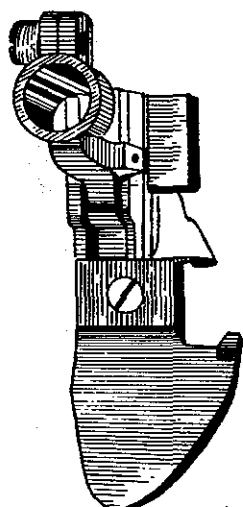
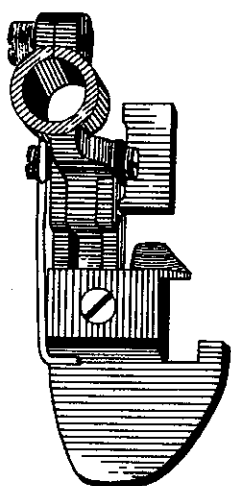

Plate No. 6 - Full Size



39220



39220F

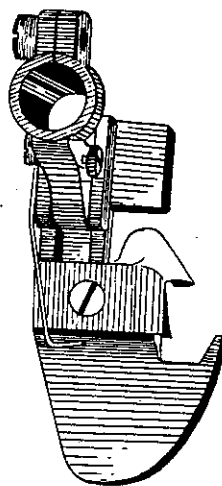

39220Q

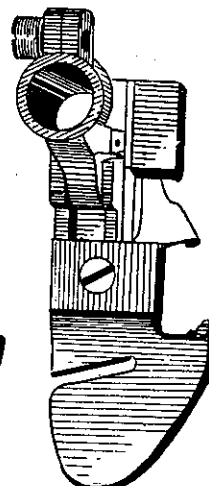

39220AH

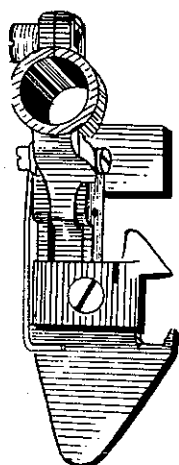

39120R

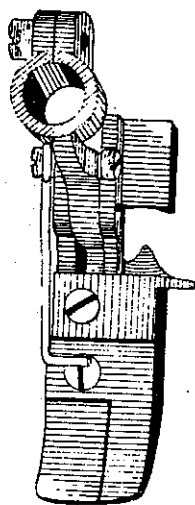

39320A

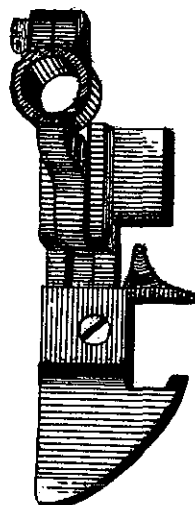

39220AE

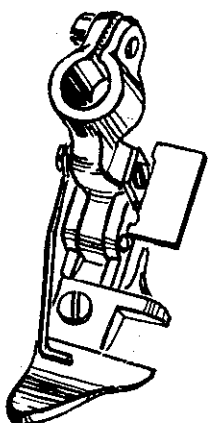

39120T

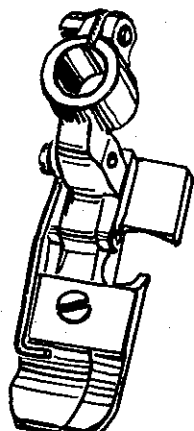

39320B

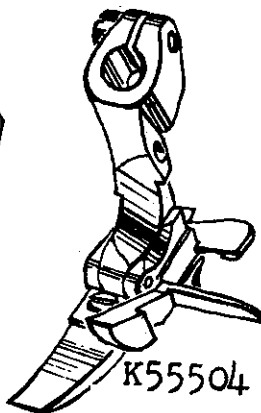

K55504

Plate No. 7 - Full Size

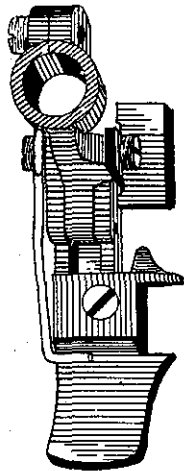

39120B

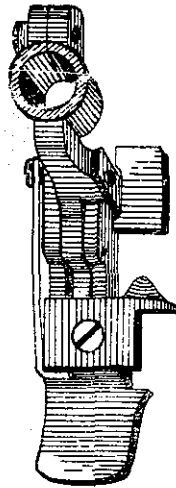

39120C

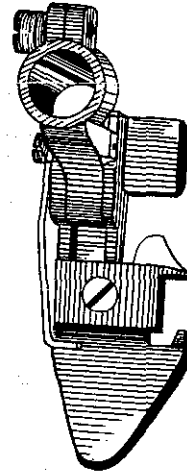

39120G

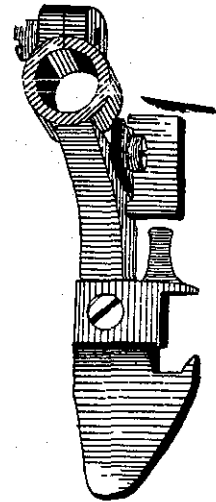

39120M

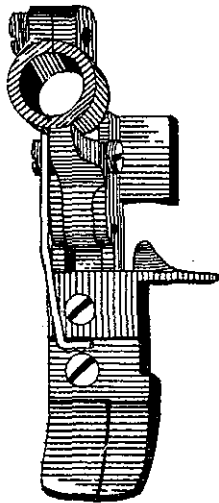

39220J

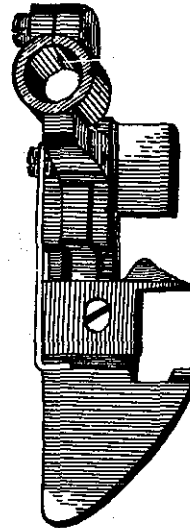

39220AC

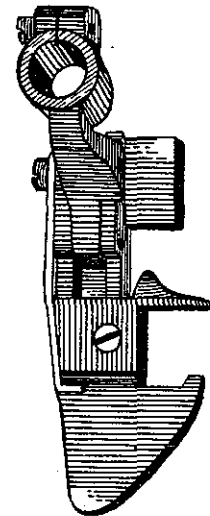

39220AD

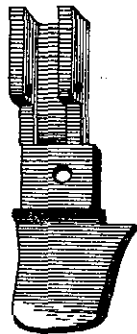

39130C

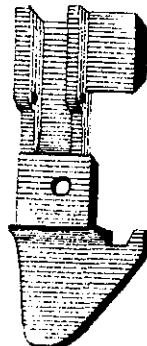

39130F

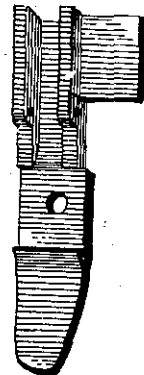

39230AN

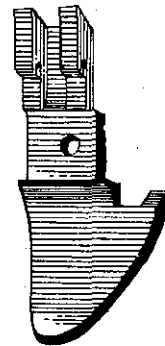

39230E

Plate No. 8 - Full Size

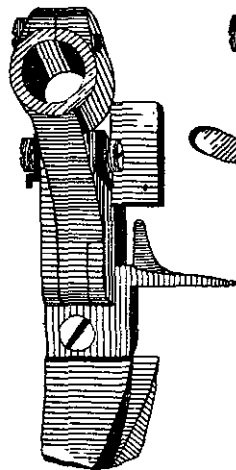

39220AS

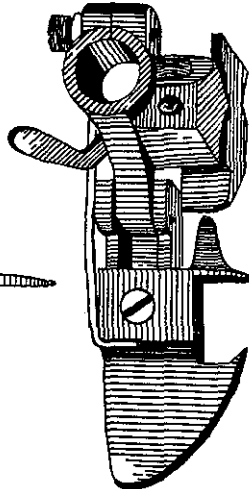

39220E

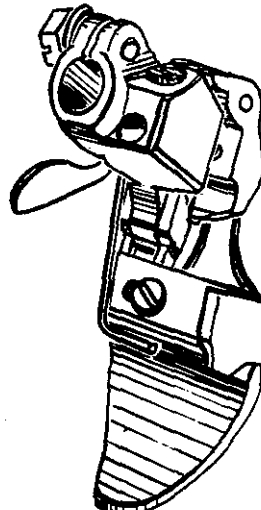

39220K

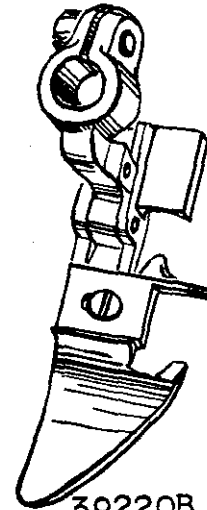

39220B

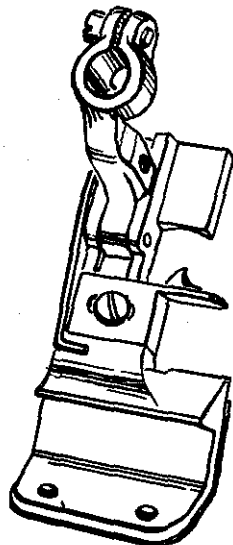

39220AR

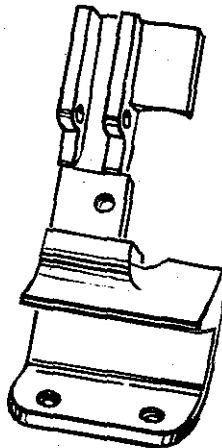

39230AR

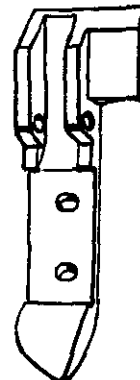

39230AU

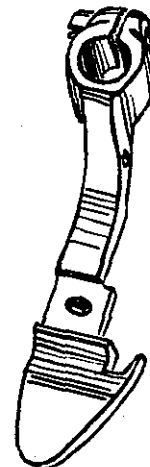

39130M

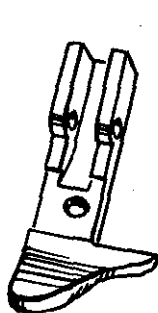

39130T

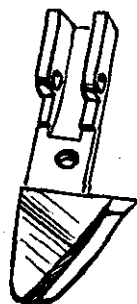

39130V

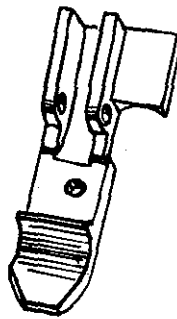

39330B

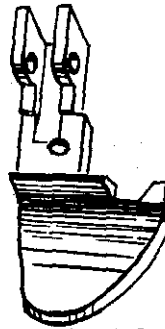

39230K

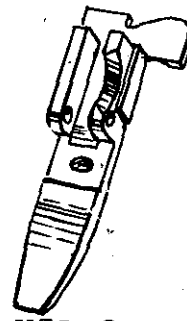

K57185

Plate No. 9 - Full Size

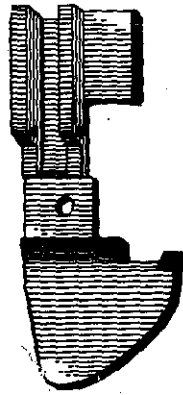

39230B

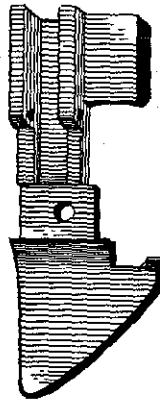

39230AE

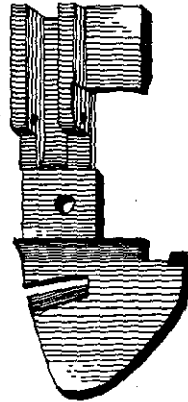

39230AH

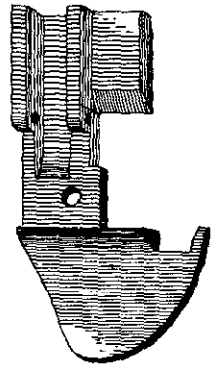

39230Q

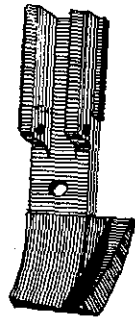

39230AS



39230F

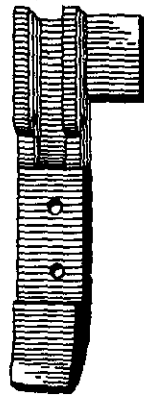

39330C

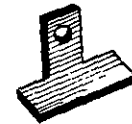

39130D



39130J



39197G

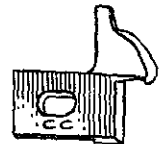

39297AH

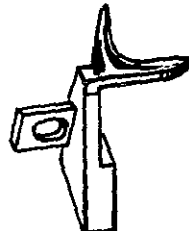

K55793



39397B

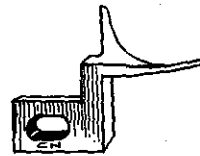

39297AS

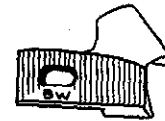

39297Q



39197R



39297AD



39397A

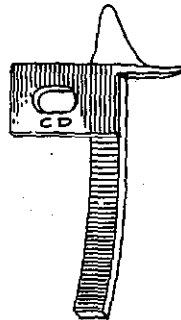

39297AN



39297J



39297F



39297AC

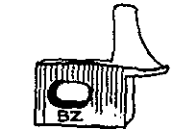

39197M



39197T

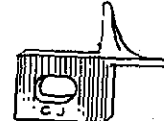

39297E

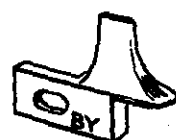

39297K



39297AU

Plate No. 10 - Full Size

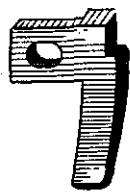

39230J



39330D



39130H



39230A



39130A

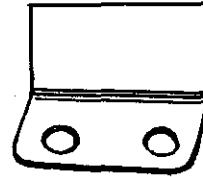

39230G



39130L

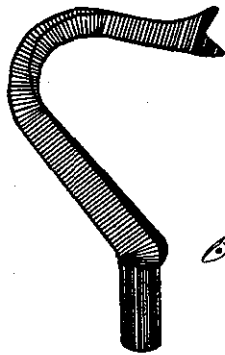

39160

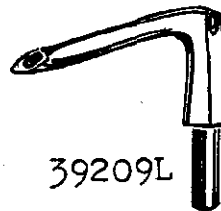

39209L

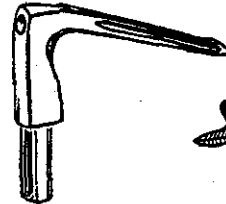

K57107

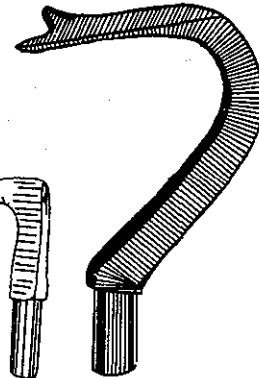

39260

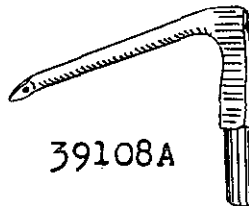

39108A

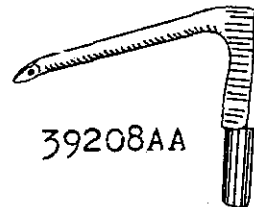

39208AA

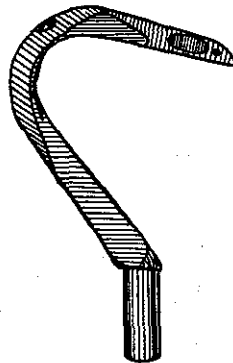

39108

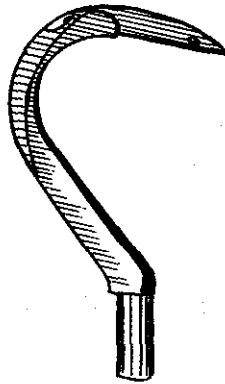

39208

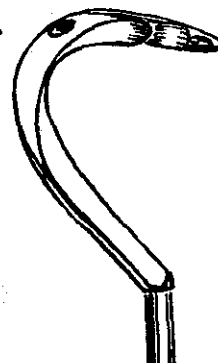

39208B

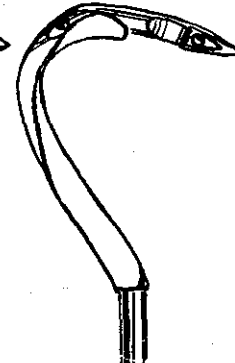

39208L

Plate No. 11 - Full Size



Plate No. 12 - Full Size

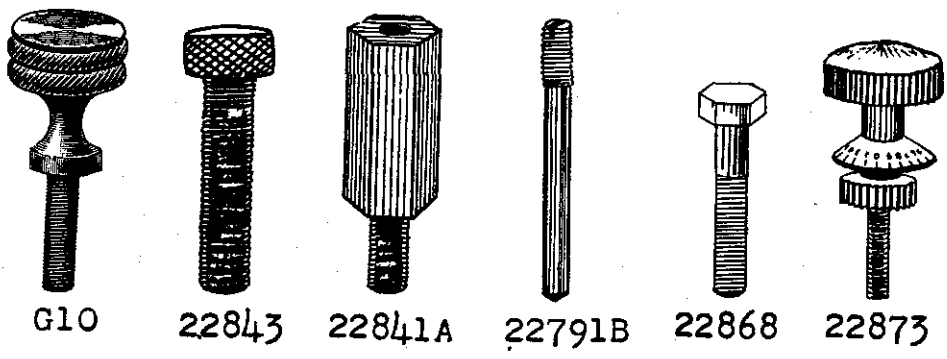
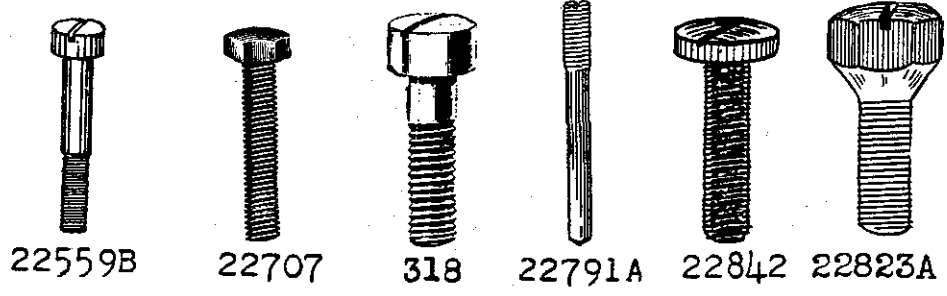
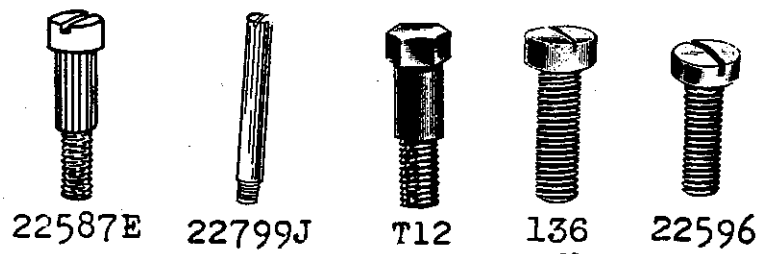
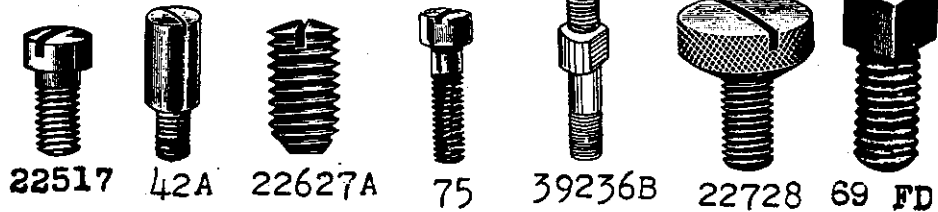
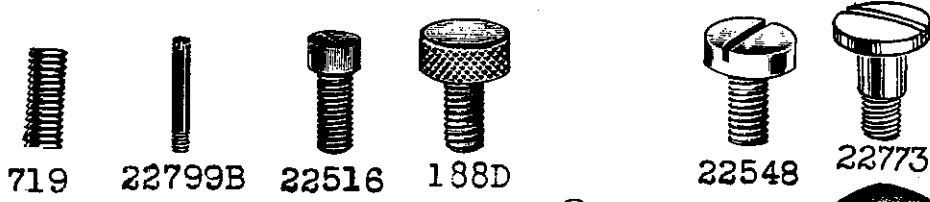
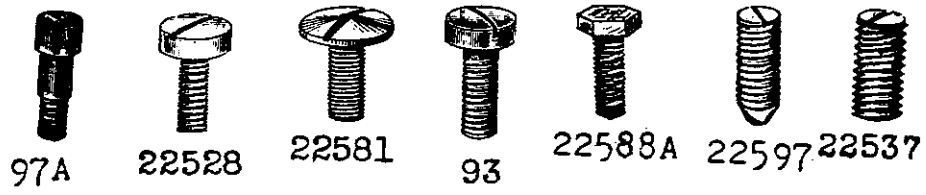

Plate No. 13 - Full Size

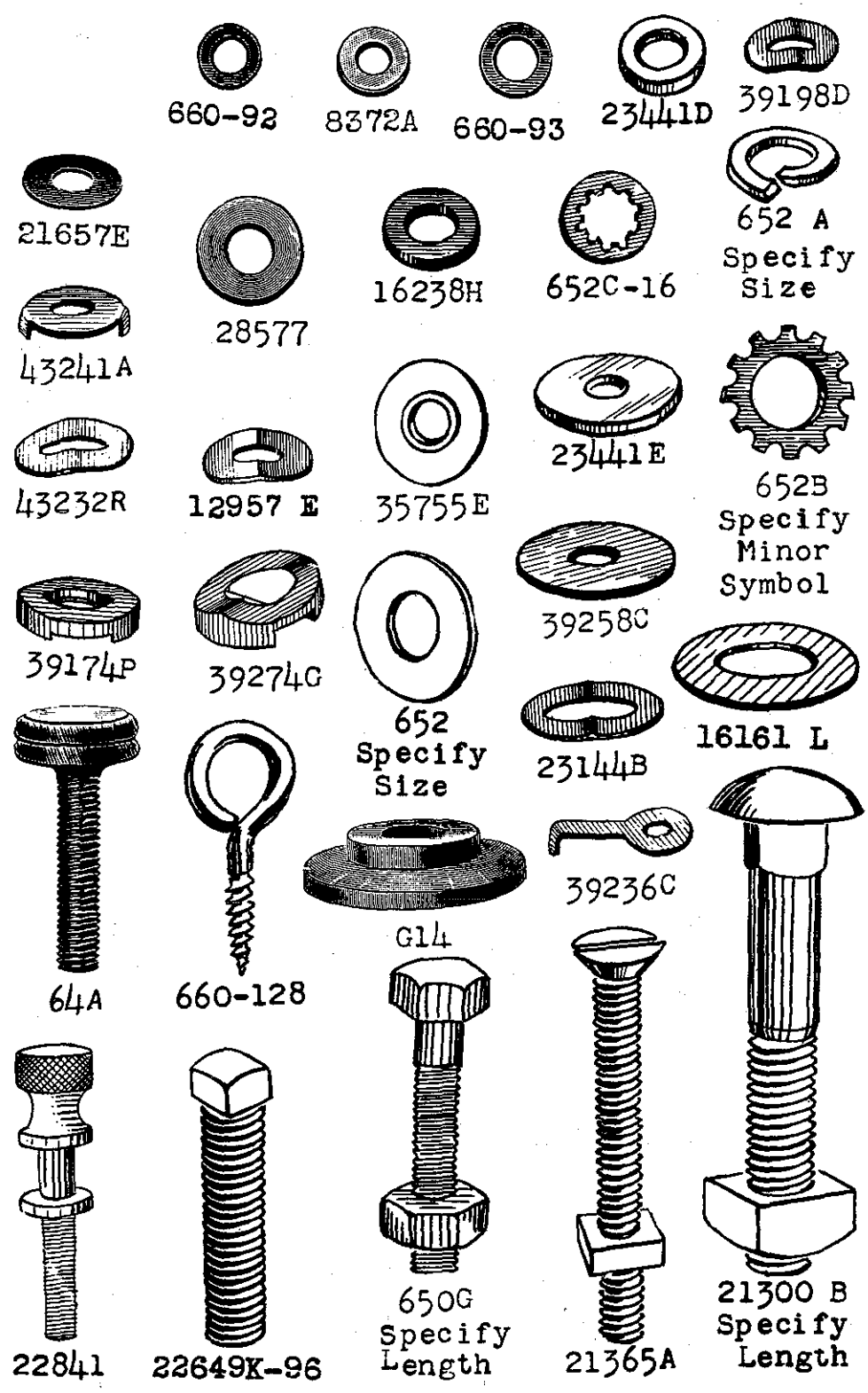

Plate No. 14 - Full Size

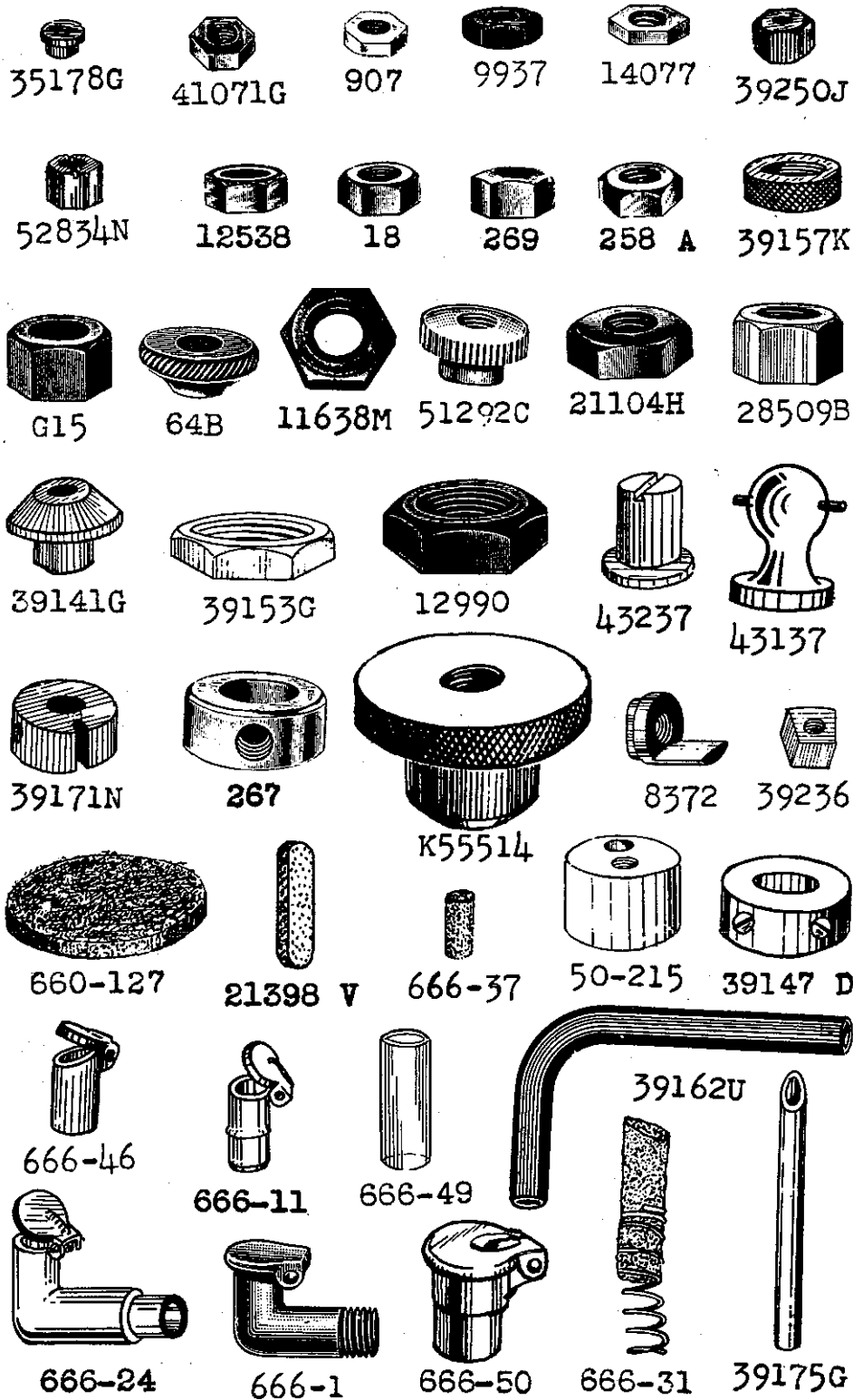
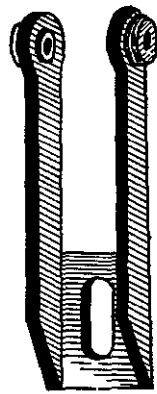
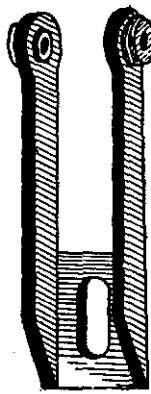

Plate No. 15 - Full Size



39167



39267

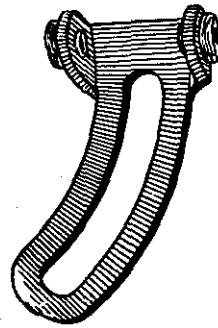

39268C

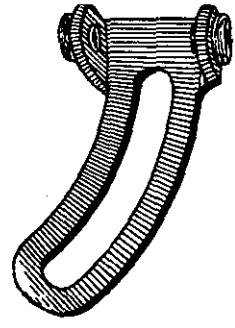

39168G

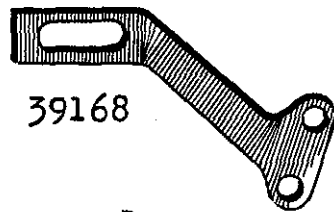

39168



39167G

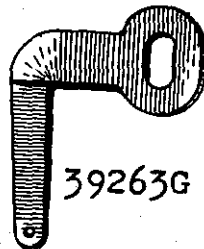

39263G

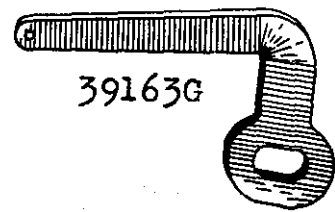

39163G



39168q



39168x

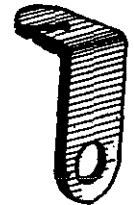

39179

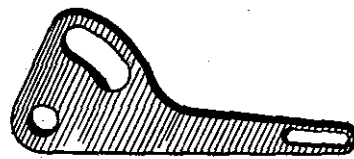

39164

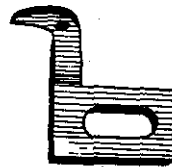

39268A

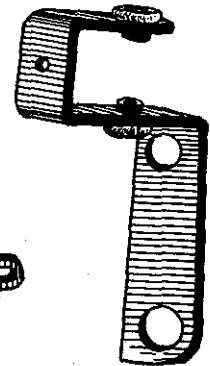

39268

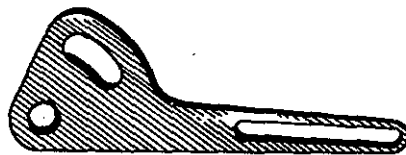

39264



43464A

Plate No. 16 - Full Size

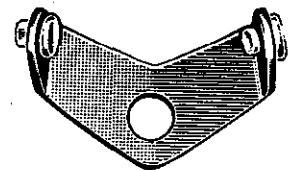
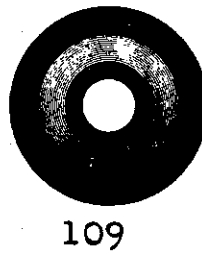
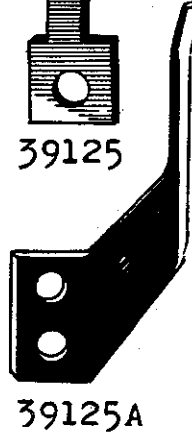
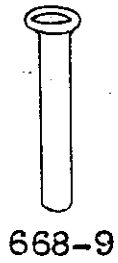
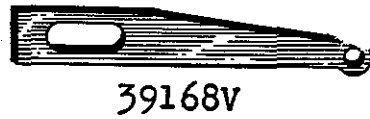
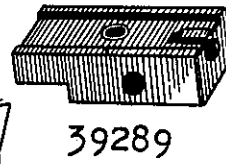
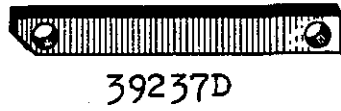
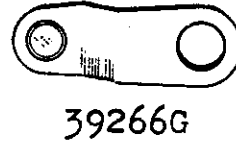
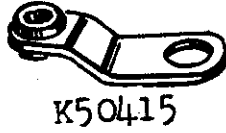
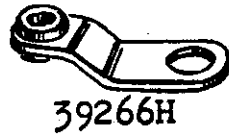
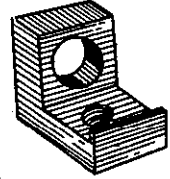
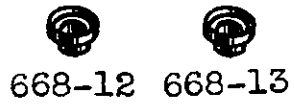
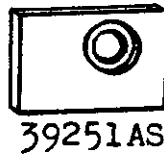
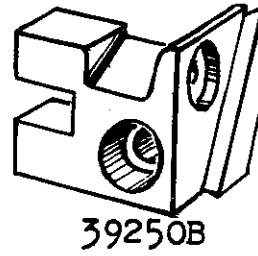
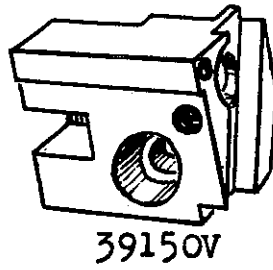

Plate No. 17 - Full Size



39270B

39270D 39250H

39250K

39171

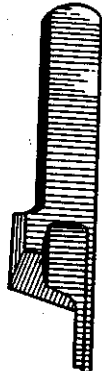

39270E

39270K

39270A



39249AU



39249K

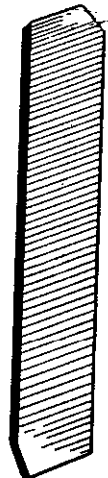

39249A

Plate No. 18 - Full Size

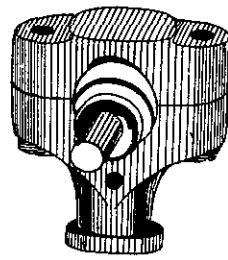

39145 E

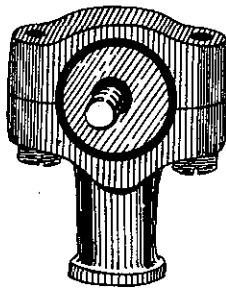

39145 G

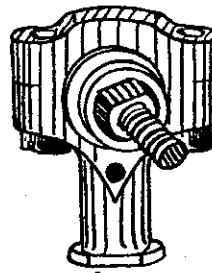

43141

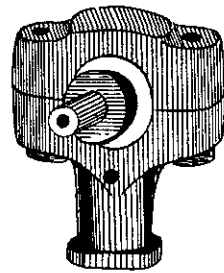

43243 H

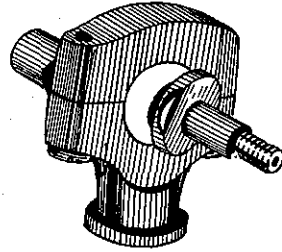

39274 N

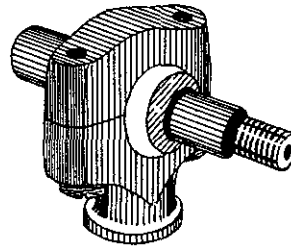

39174 U

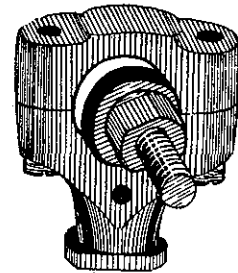

43241 D



39152 N



39252 N

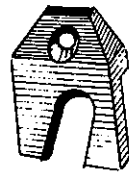

39144 U



41255 B



39144 V

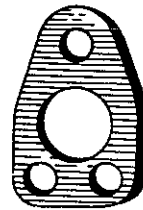

39240 E

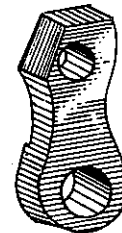

39236 N



39136 N

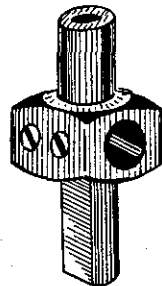

39237

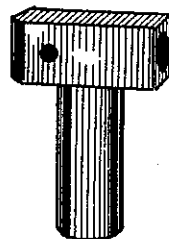

39137

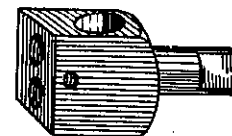

39152

Plate No. 19 - Full Size

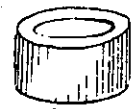

39135N



K57186



39180G



39236



50-214



51280K



39180W



39142G



39142H



39147G



35737A



39191G



39157J



39147N



21113 B



39136Q



39140U



39140V



39135G

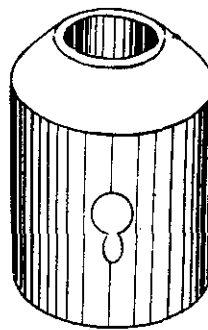

39190G

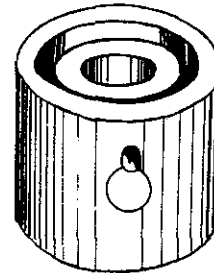

39190



39132 V



39171R

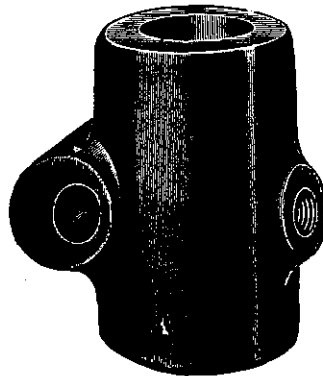

21217A

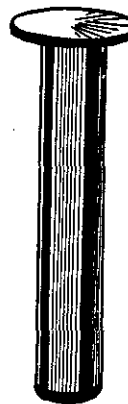

43232N



39142A

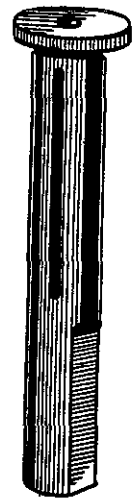

39174G

Plate No. 20 - Full Size

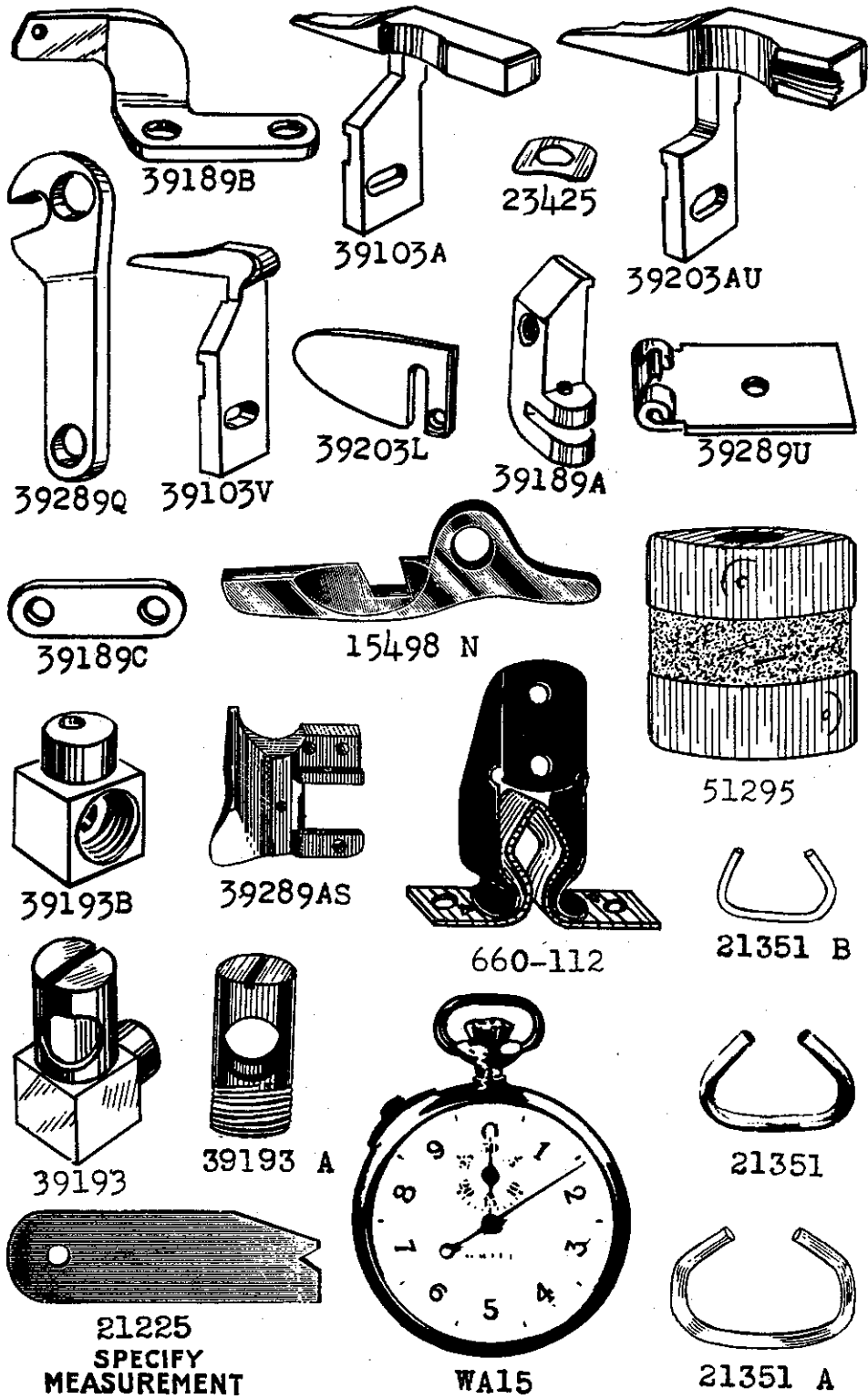
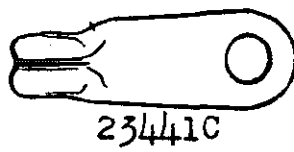
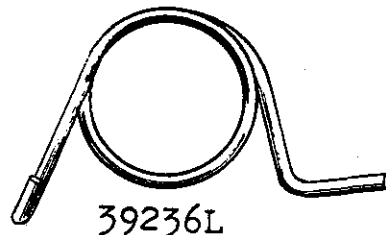

Plate No. 21 - Full Size



23441C



39236L



35587B



39155N

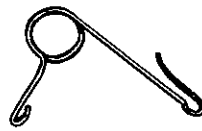

39268B

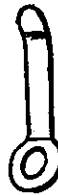

39289V

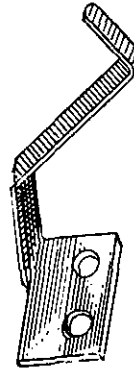

43232



15498H



39173



39173A



39130G

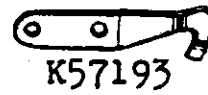

K57193

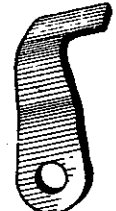

39289G



51292 F-2



51292 F-4



51292 F-1



3336



51292 F-5



51292 F-8

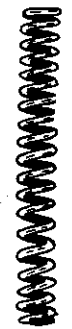

39158U



426



39157

Plate No. 22 - One-Half Size

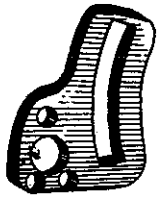

39240D



39240F

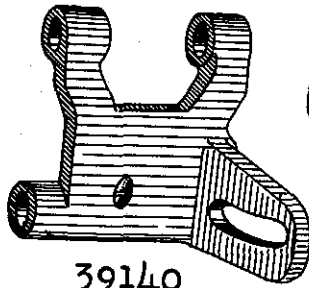

39140

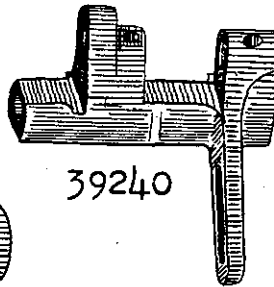

39240

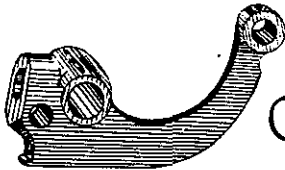

39243



28505



39152U
Specify
Minor
Symbol 39236H

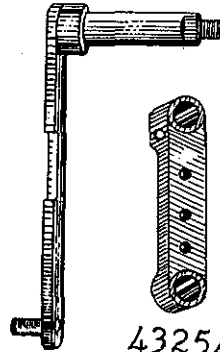

43254

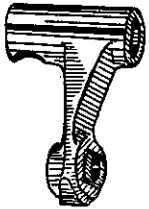

39374

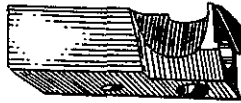

39250A

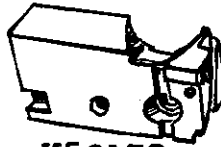

K50132



21398U

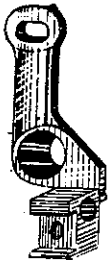

39139

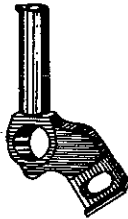

39134A

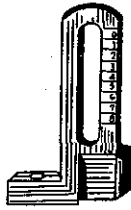

39236J



753



9271

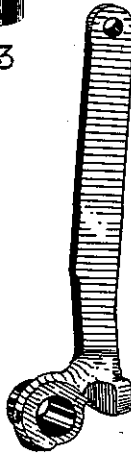

39155



43255B

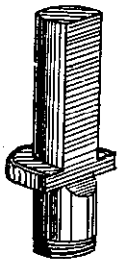

39253



39234A



39147



39236G

Plate No. 23 - One-Half Size

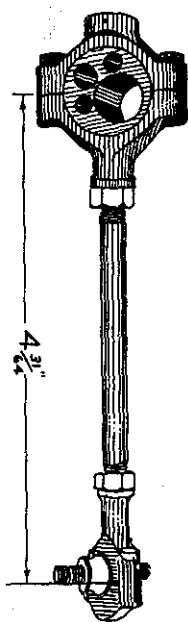

29477

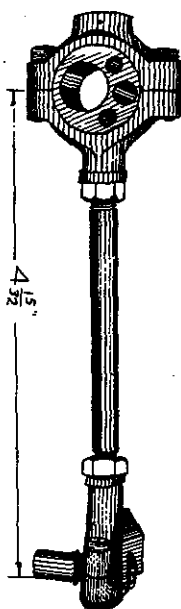

29477F

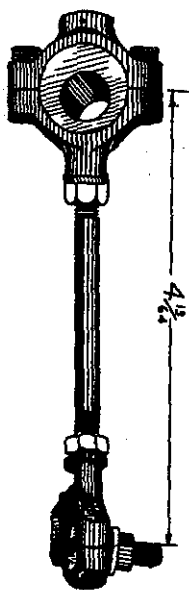

29477G

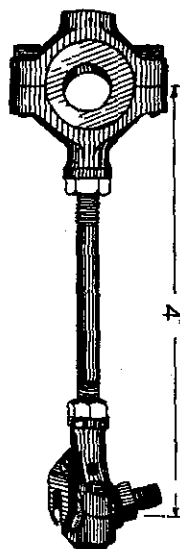

29477J

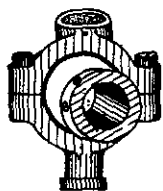

29126A

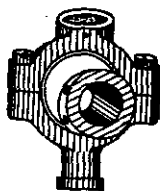

29126G

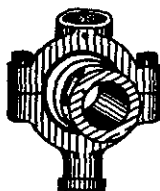

29126 N

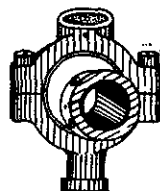

29126 P

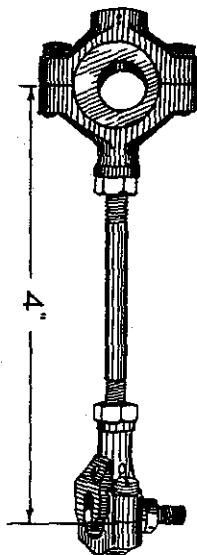

29477K

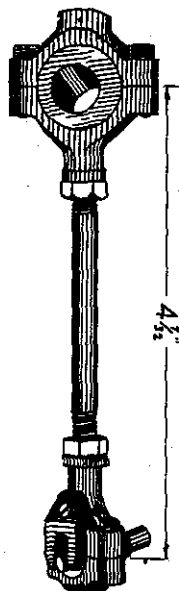

29477L

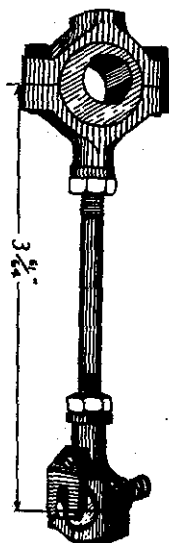

29477M

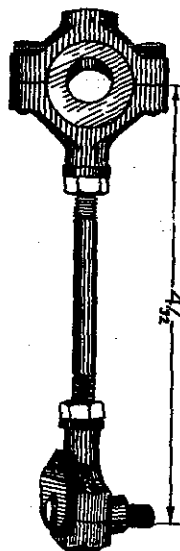

29477S

Plate No. 24 - One-Half Size

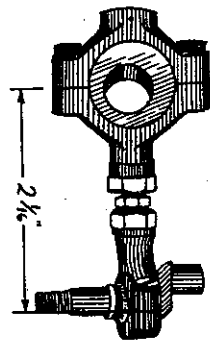

29477H

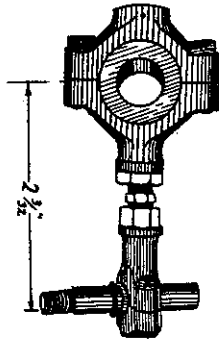

29477N

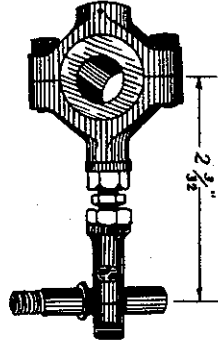

29477Q

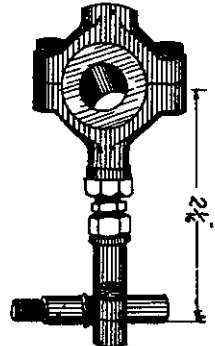

29477R

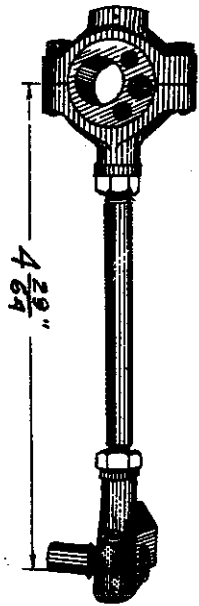

29477AB

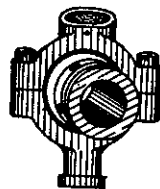

29126U

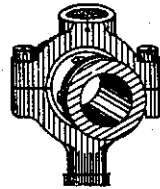

29126 V

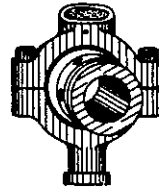

29126 W

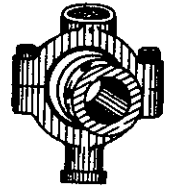

29126X

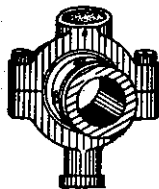

29126Z

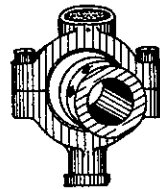

29126AB

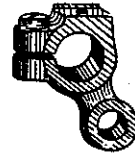

39142J



39142N

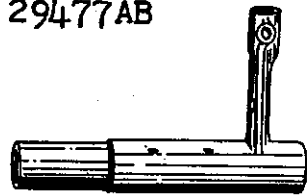

39113

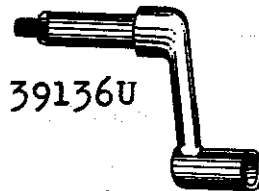

39136U

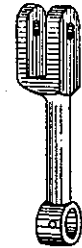

39236T



39238A



39138



39238



39238H



39236U

Plate No. 25 - One-Half Size



39195 A



39143G



39195



39158N



22871

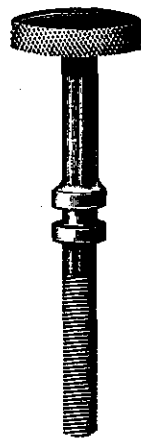

15498K



41064B



15498J



39144

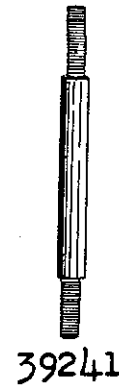

39241

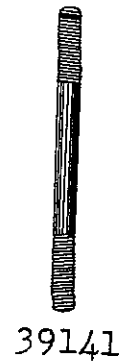

39141

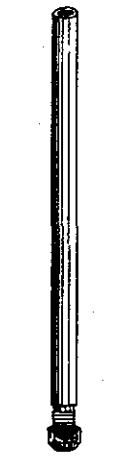

39117

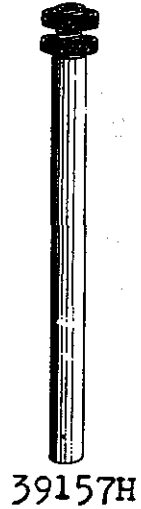

39157H



G12

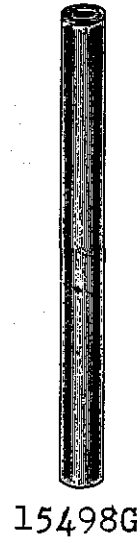

15498G



21113 A

Plate No. 26 - One-Half Size

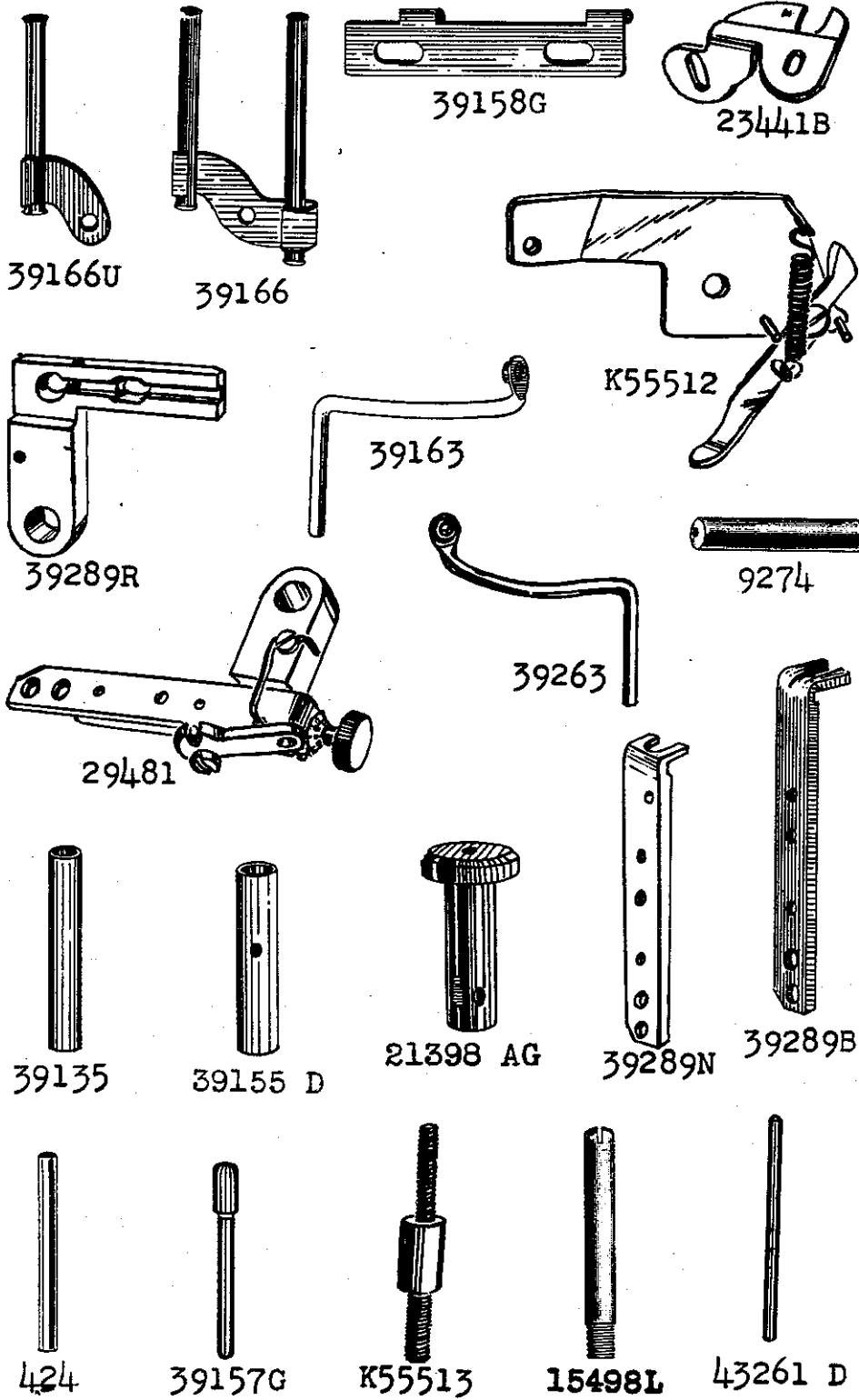
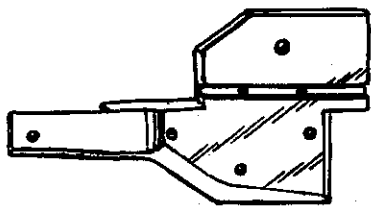
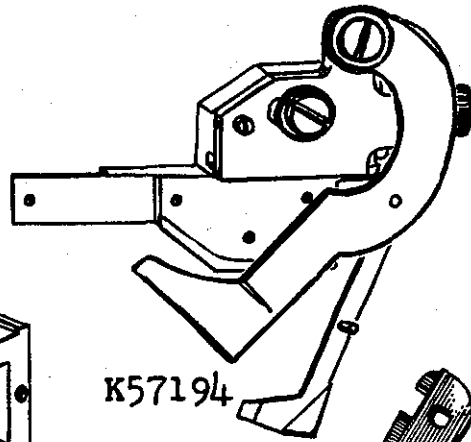

Plate No. 27 - One-Half Size



K55508



K57194

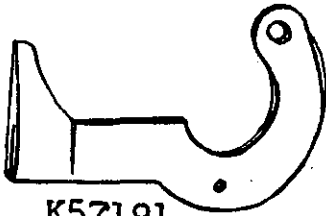

K57191



39180V



K57192

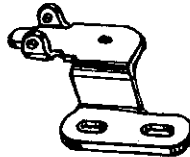

39289T

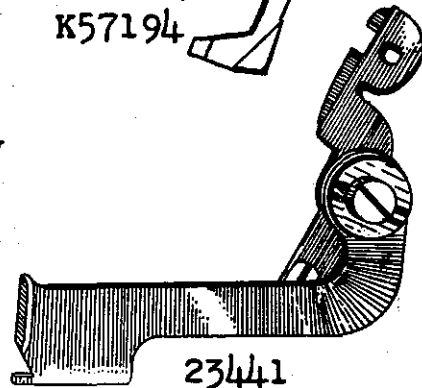

23441

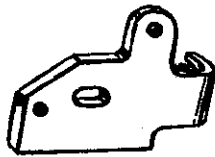

K57190

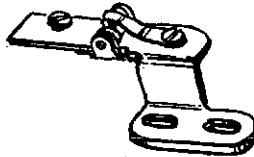

29481A

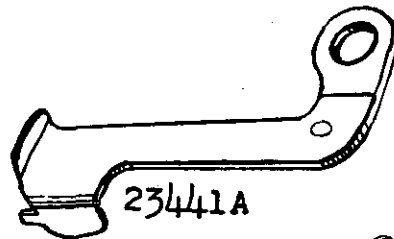

23441A



39303B

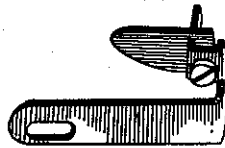

39203J

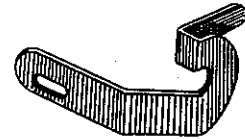

39303

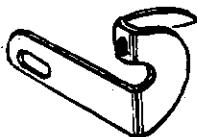

39203K



39289S
Specify
Width



39189
Specify
Width



39289H
Specify
Width

Plate no. 28 - One-Half Size

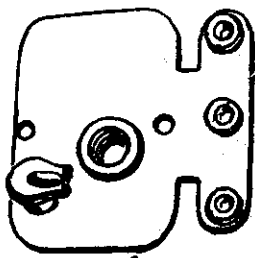

39165A

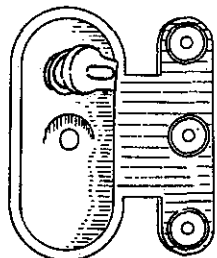

39165

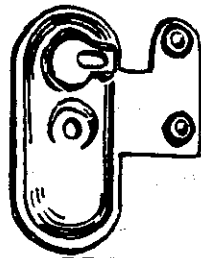

K55510

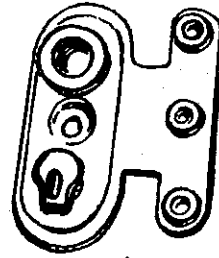

39165B

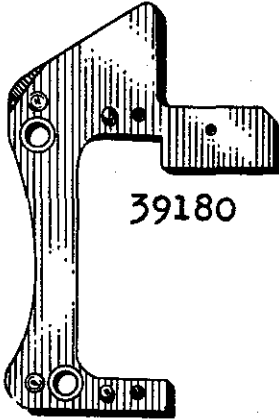

39180

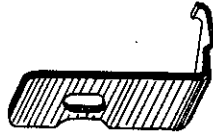

39278A

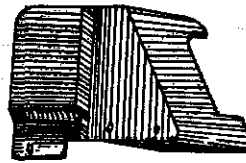

39178V

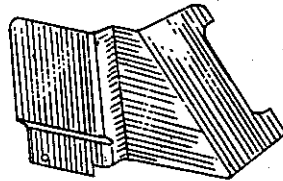

39178



21369 C

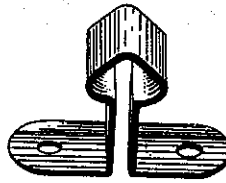

21369 D

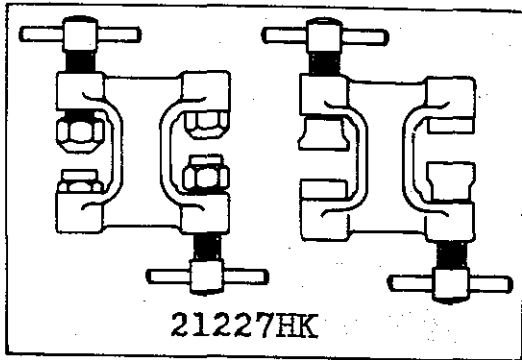

21227HK

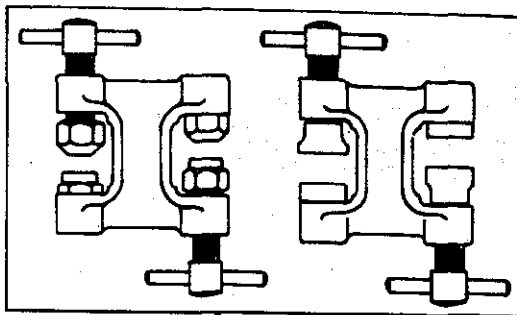

21227HH

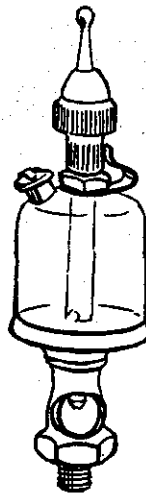

666-79

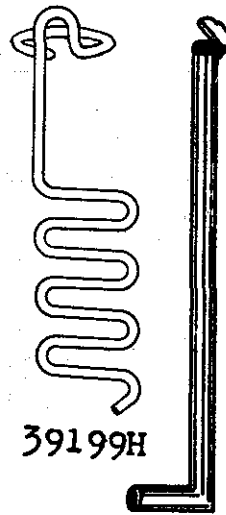

39199H

666-61

Plate No. 29 - One-Half Size

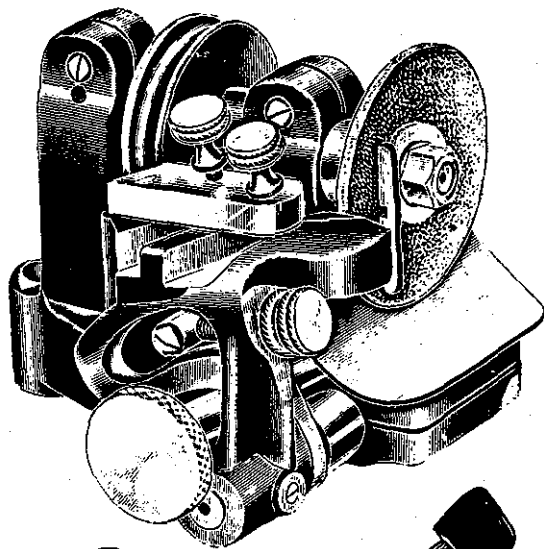

15498P

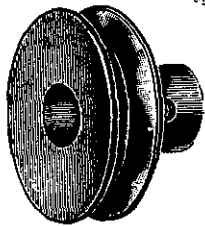
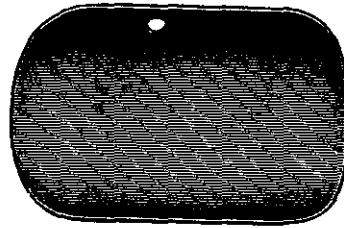

G11

39298

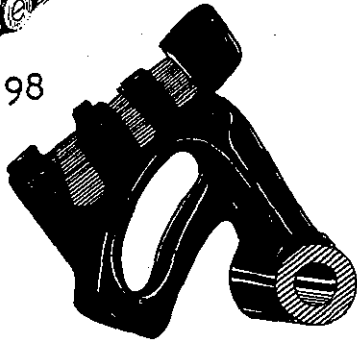

39198E

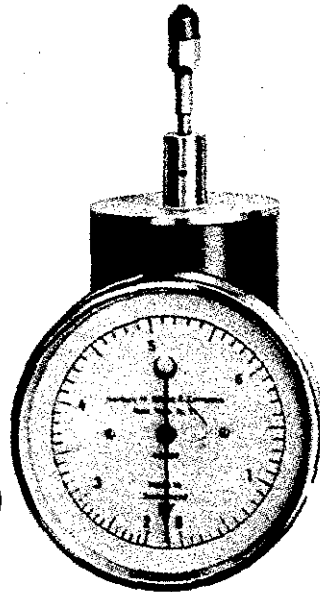

TA55

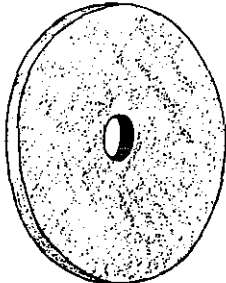

G16



39198F

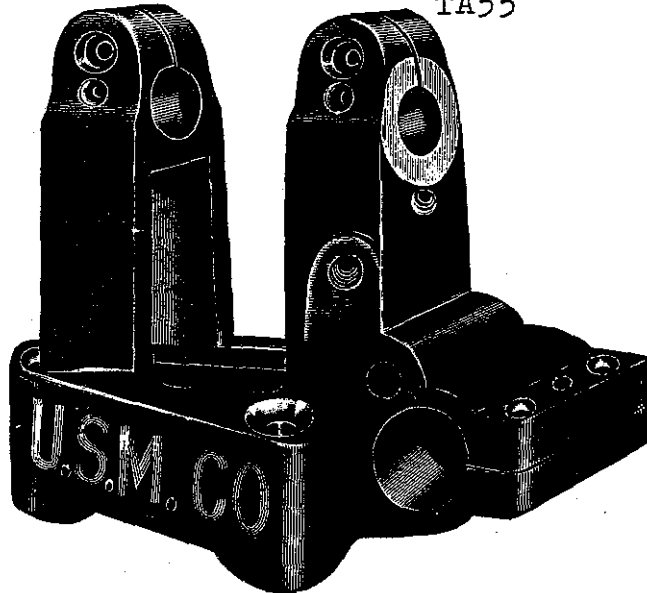

15498 E



39198C

Plate No. 30 - One-Half Size

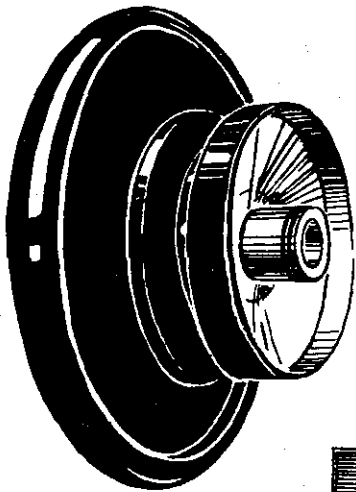

43221

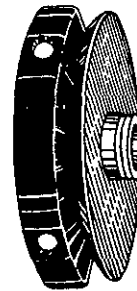

39121

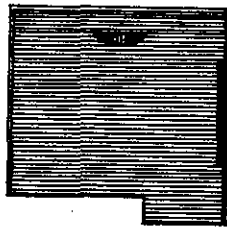

39161



23446



39195 B

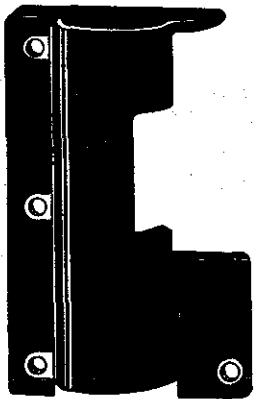

39162

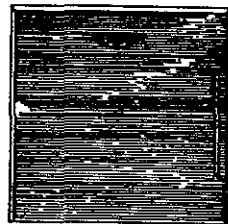

39161A



21398 T

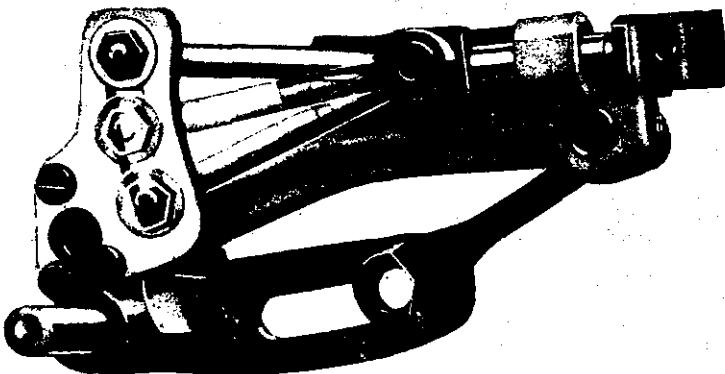

29459C

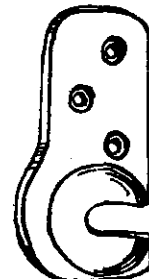

K55516

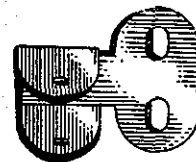

43281 J

Plate No. 32 - One-Fourth Size

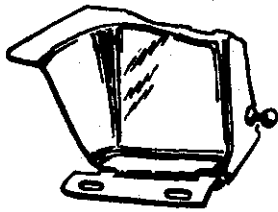

39258

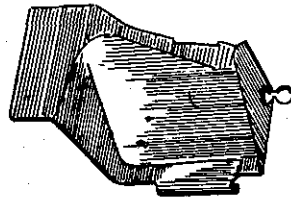

39258A



K55515

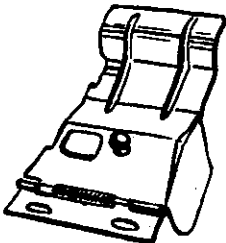

39158X



39222

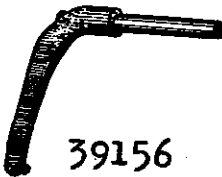

39156



39122



39134



39134B



39174



39234

Plate No. 33 - One-Fourth Size

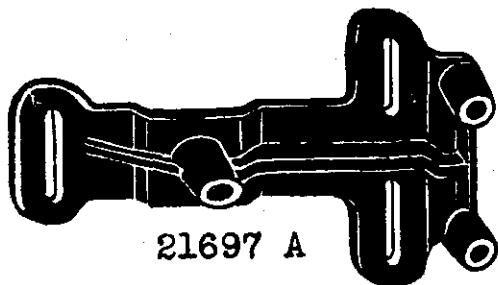

21697 A



21662



21664



21665

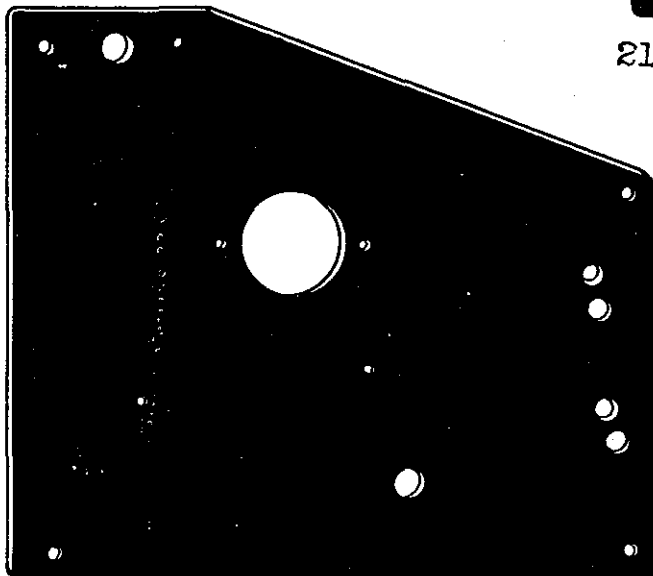

21680 AF

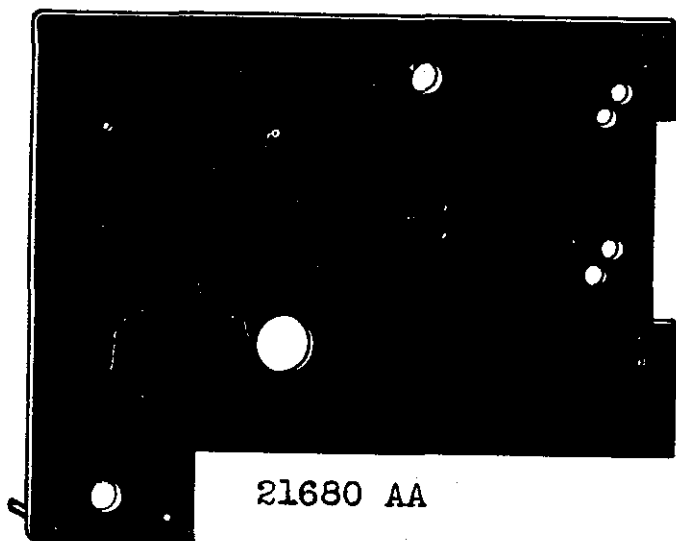

21680 AA

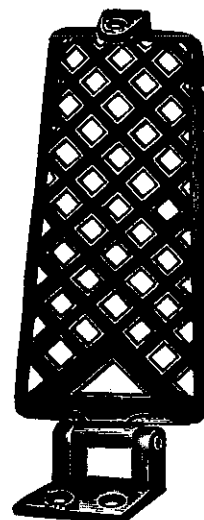

29402

Plate No. 34 - One-Fourth Size

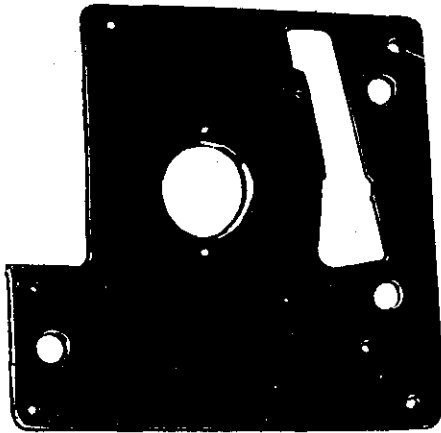

21680AQ

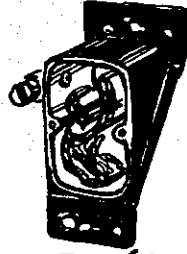

39162J

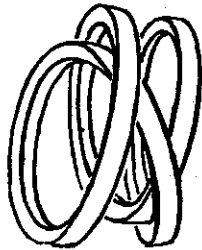

21262H
Specify
Length

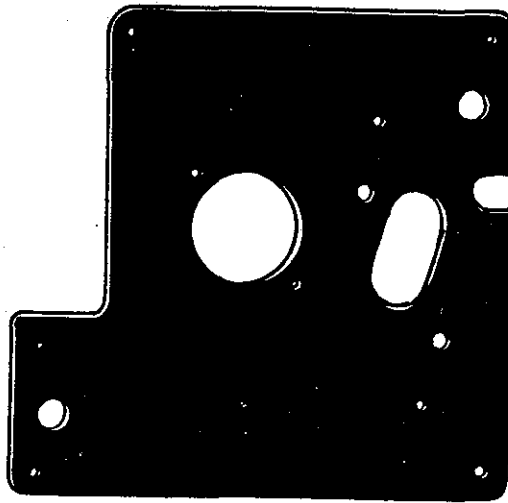

21680 AL

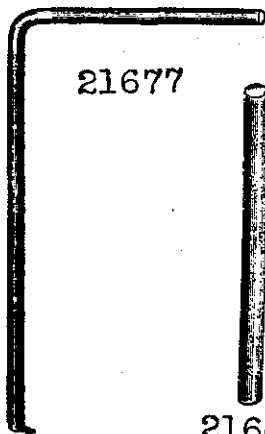

21677

21661

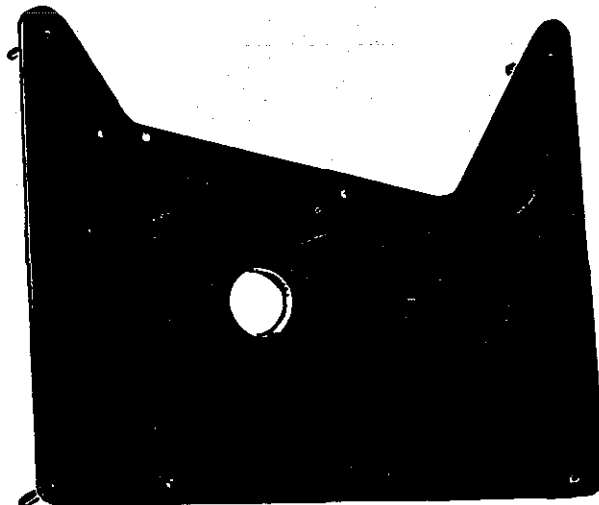

21680AR

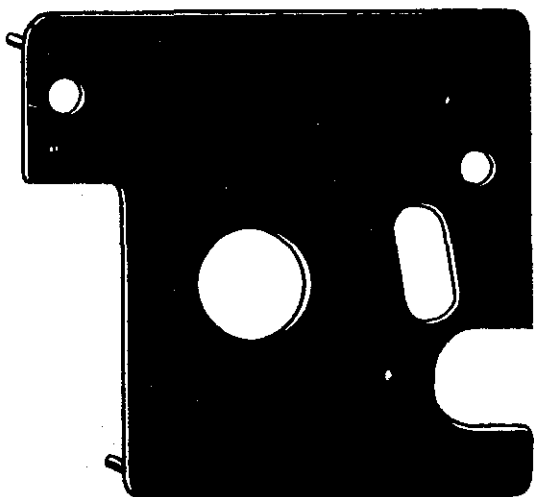

21680 AM

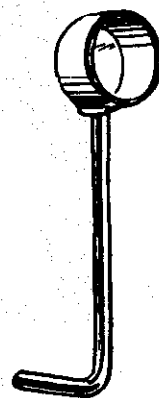

43294F



21679

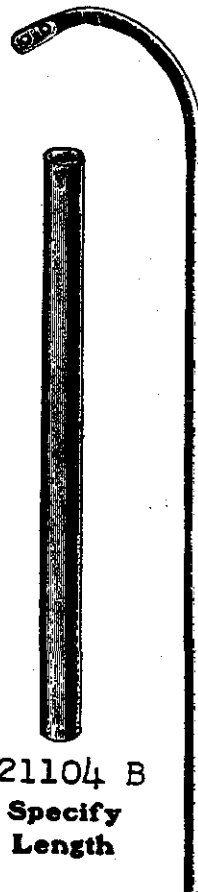
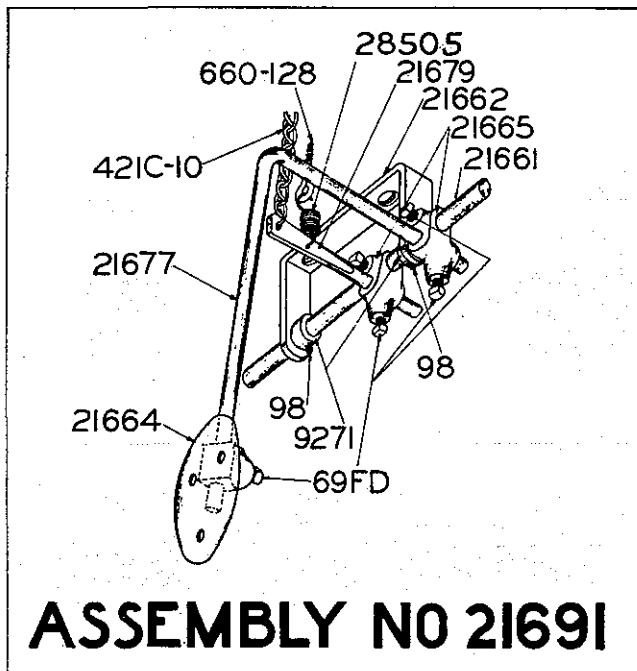

21104 B
Specify
Length

100 B

Plate No. 36 - One-Fourth Size

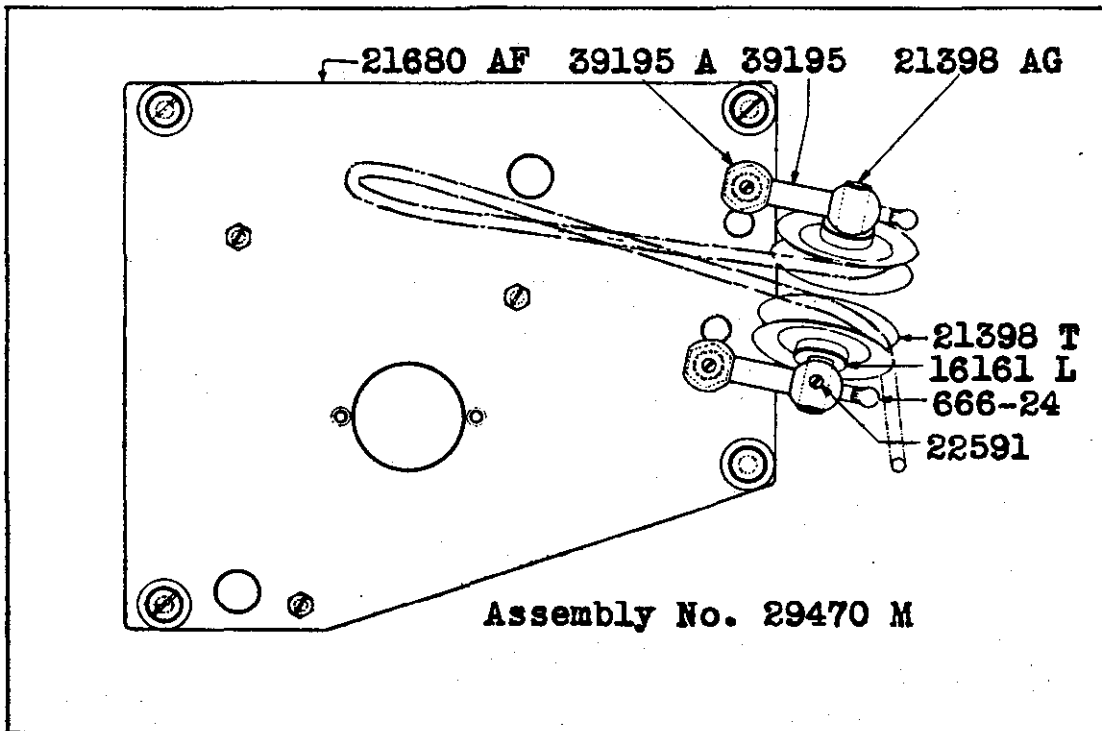
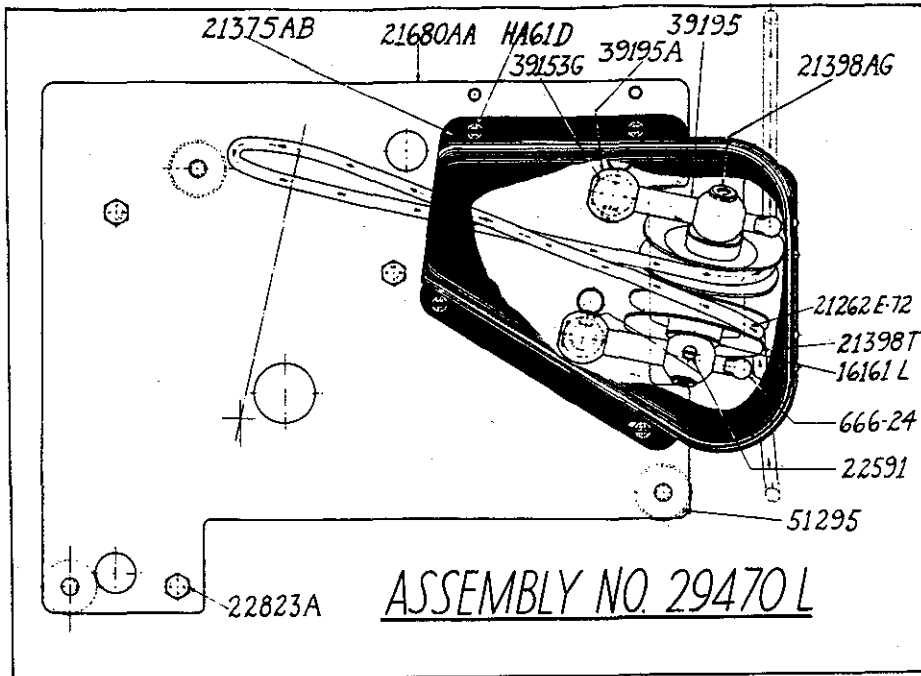

Plate No. 37 - One-Fourth Size

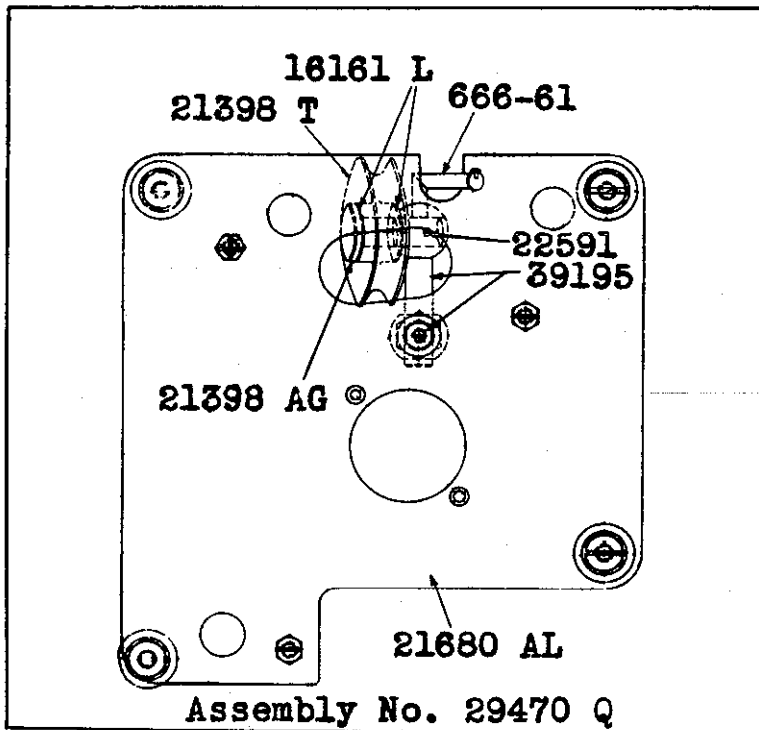
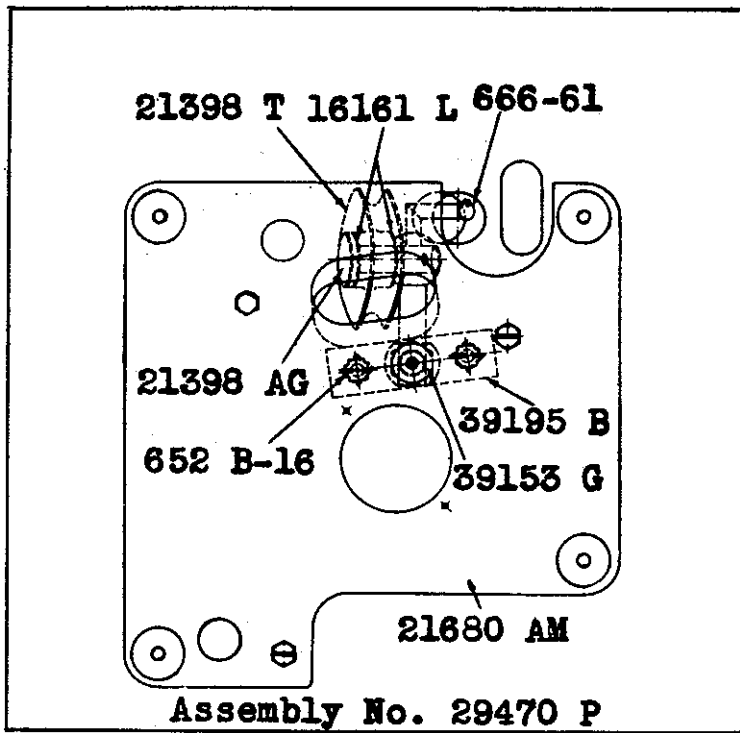
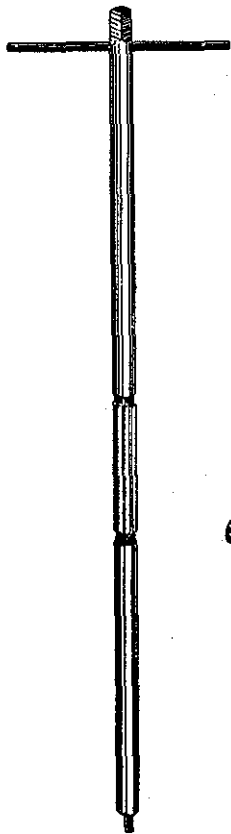

Plate No. 38 - One-Fourth Size



Y 676



21236

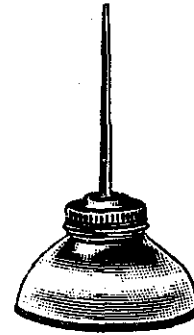

413

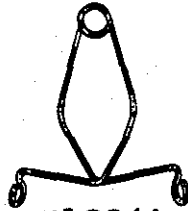

51294A

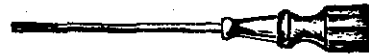

21201

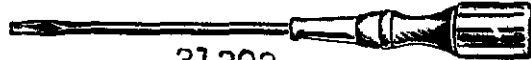

21202

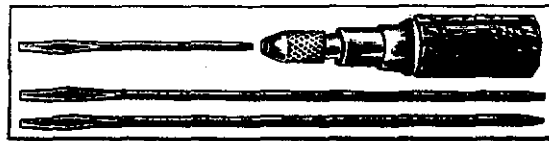

21208

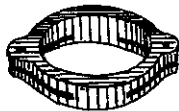

43294A



21205A

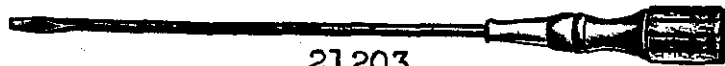

21203



21204

Plate No. 39 - One-Eighth Size

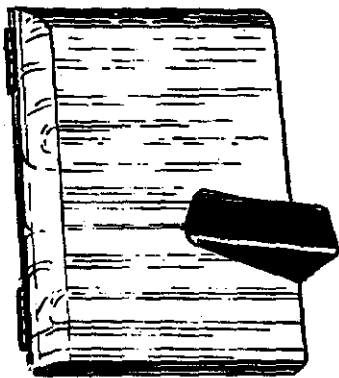

21376J



21375 AB



21114 A

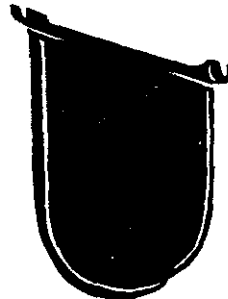

21375AP

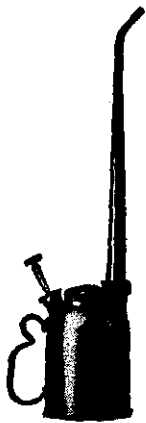

OI-19

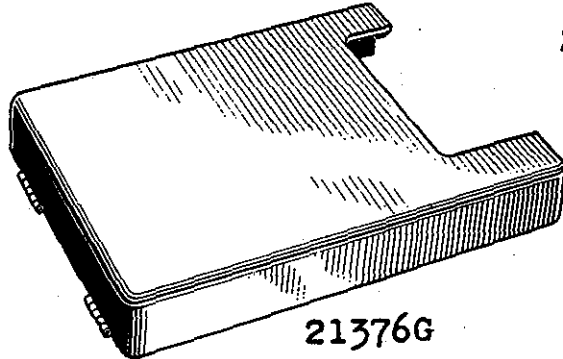

21376G



69 S



21697U



21220C

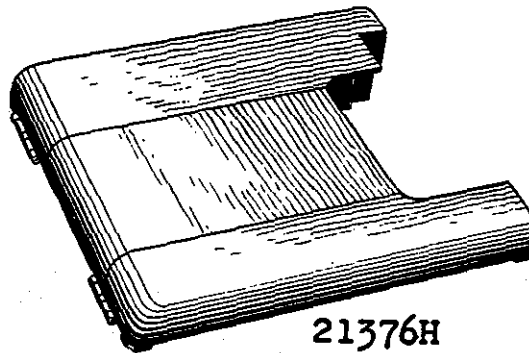

21376H

Plate No. 40 - One-Eighth Size



39101A



39201



K55511



39201A



39201AN



39201AR



39201AS



39162 C



39162N



39162NA



39162NB

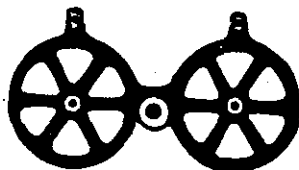

21130 A-2

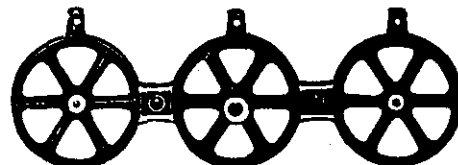

21130 A-3

LIST OF PARTS

Symbol to Order By	The figures in the last column refer only to the plates illustrating the parts and are not to be used in ordering. Refer to insert for prices.	Plate No.
G10	Thumbscrew, for holding knives in grinder No. 39298- - - - -	12
G11	Pulley, for knife grinder No. 39298 (screw No. 98)- - - - -	29
G12	Pulley Spindle, for knife grinder No. 39298 (clamp screw No. 136)- - - - -	25
T12	Cloth Plate Latch Pin, for Style 39200 J - - -	12
G14	Pulley Spindle Washer, for knife grinder No. 39298 - - - - -	13
G15	" " Nut, for knife grinder No. 39298	14
WA15	Stop Watch - - - - -	20
G16	Emery Wheel, for knife grinder No. 39298 - - -	29
18	Connecting Rod Nut, right thread - - - - -	14
OI-19	Pressure Pump Oil Can, 1 1/2 pints capacity- -	39
25 CC	Screw, for differential feed control lever stop on Style 39200 AN - - - - -	11
28	Screw, for top guide on gauge assembly No. 39203 J; also for No. K57194 - - - - -	11
42 A	Cloth Plate Latch Pin; also for Nos. 39155, 39278 A, 43255 B - - - - -	12
50-214	Cloth Plate Stop Pin, for Style 39200 AS - - -	19
50-215	Button, for sheet metal side cover on Style 39200 AS (screw No. 75)- - - - -	14
52 A	Upper Looper Rocker Thread Eyelet, left, for lower looper thread on Styles 39100 C, 39100 M, 39100 N, 39200 K, 39200 L, 39200 Q, 39200 AH, 39200 AN (screw No. 22768) - - - -	16
TA55	Hand Tachometer, 2000 to 8000 R.P.M. - - - -	29
57 WD	Screw, for edge guide on Style 39200 AU- - - -	11
HA61 D	" for attaching belt guard assembly on American Safety Table and Singer Safety Table with two line shafts- - - - -	11
64 A	Swinging Frame Adjusting Screw, for knife grinder No. 39298- - - - -	13
64 B	Swinging Frame Adjusting Screw Lock Nut, for knife grinder No. 39298- - - - -	14
69 S	Spool Pin, 4 inches long, for thread stand - -	39
69 FD	Set Screw, square head, cup point, 5/16 inch diameter, 18 threads per inch, 5/8 inch long, for thread stand seat; also for Nos. 21664, 21665, 21677, 21679 - - - - -	12
73 A	Screw, for fabric guard; also for Nos. 23441, 39268 B, 39281, K55793 - - - - -	11
HA73 B	Screw, for upper looper rocker link pin- - -	11
75	" for sheet metal side cover button on Style 39200 AS- - - - -	12
77	Set Screw, for looper and spreader; also for Nos. 39130 J, 39171 N- - - - -	11
86	Pivot Screw, for retractable hemming guide lever on Style 39200 AV; also for No. 15498 N- - - - -	11

LIST OF PARTS

Symbol to Order By	The figures in the last column refer only to the plates illustrating the parts and are not to be used in ordering. Refer to insert for prices.	Plate No.
87 U	Screw, for needle bar link thread guide; also for Nos. 39165, 39167 G, 39168 N, 39168 Q, 39168 U, 39168 V, 39168 X, 39168 Z, 39268 A-	11
88	Set Screw, for main shaft eccentrics; also for Nos. 21113 B, 39147 D, 39152-	11
89	Screw, 3/16 inch long, for feed lift link stud; also for Nos. 39134, 39134 B-	11
90	Screw, for front needle thread eyelet; also for Nos. 39163 G, 39167, 39168 G, 39251 AS, 39263 G, 39267, 39268 C, 39289 G, 39289 P, K57193-	11
91	Clamp Screw, fillister head, for presser feet	11
91 A	Screw, for presser foot stripper blade on Style 39200 AR	11
93	" 7/16 inch long, for feed dogs; also for Nos. 39113 A, 39155 A-	12
93 A	" 9/32 inch long, for feed dogs; also for Nos. 15498 G, 23441 B, 39139	11
94	" 1/4 inch long, for feed dogs; also for Nos. 39166, 39166 U, 39289 AS-	11
96	Spot Screw, for round belt pulley	11
97	Screw, for lower knife holder needle guard; also for No. 39239-	11
97 A	" for connecting rod ball joints	12
98	Set Screw, for pulley on knife grinder No. 39298; also for Nos. 267, 9271, 39121-	11
100 B	Thread Stand Wire, 16 inches long (screw No. 22632 F-24)	35
109	Tension Disc, with contact surface 5/64 inch wide, for machines using needle threads the equivalent in size of No. 50 or smaller	16
116	Wrench, 1/4 inch opening, for needle clamp nut-	31
136	Screw, for throat plate support on Style 39100 V; also for Nos. G12, 15498 J-	12
187 A	Screw, for overhanging guide on Style 39200 AU-	11
187 B	" for cloth plate spring on Styles 39100 V, 39200 AS, 39200 AT, 39200 AV; also for No. 39289 V-	11
188 D	Thumbscrew, for tape reel axle collar on Style 39200 AJ; also for No. 21220 C-	12
222 D	Screw, for oil reservoir cover and lead-in thread eyelet on Styles 39100 C, 39100 M, 39100 N, 39100 S, 39200 J, 39300 A, 39300 B-	11
258 A	Lower Looper Connecting Rod Ball Joint Nut-	14
267	Swinging Frame Pivot Pin Collar, for knife grinder No. 39298 (screw No. 98)-	14
269	Connecting Rod Nut, left thread	14
318	Screw, for throat plate support on Style 39200 AS	12
413	Oil Can, complete	38

LIST OF PARTS

Symbol to Order By	The figures in the last column refer only to the plates illustrating the parts and are not to be used in ordering. Refer to insert for prices.	Plate No.
421 C-10	Chain, 10 inches long, for knee press assembly No. 21691- - - - -	31
421 C-34	Lifter Lever Chain, 34 inches long - - - - -	31
423	" " Base- - - - -	31
424	" " Pin (set screw No. 22813) - - -	26
426	Spring, for retractable guide lever on Style 39200 AV - - - - -	21
531	Set Screw, for feed rocker shaft; also for Nos. 9274, 39135, 39142 G, 39142 H, 39162 U, 43232 N- - - - -	11
604	Screw, for presser foot tongue; also for Nos. 39230 J, 39230 L, 39330 D- - - - -	11
605	Screw, for needle bar cross head thread guide on Styles 39100 N, 39200 K, 39200 L, 39200 Q, 39200 AN- - - - -	11
650 G-10	Machine Bolt, hexagonal head, 5/16 x 1 1/4 inches, for attaching "Electro Drives" to bracket on sub-assemblies Nos. 29470 P, 29470 Q- - - - -	13
650 G-12	Machine Bolt, hexagonal head, 5/16 x 1 1/2 inches, for attaching "Electro Drives" to belt take-up and hanger on "V" belt installations (washer No. 652 A-20)- - - - -	13
650 G-18	Machine Bolt, hexagonal head, 5/16 x 2 1/4 inches, for attaching "Electro Drives" to belt take-up and hanger on "V" belt installations (washer No. 652 A-20)- - - - -	13
652-12	Washer, 3/16 inch, for belt guard on non-submerged isolated "Electro Drive" "V" belt installations- - - - -	13
652-20	Washer, 5/16 inch, for "Electro Drive" attaching bolts on round belt installations- - - - -	13
652-24	Washer, 3/8 inch, for belt take-up and hanger attaching bolts on "V" belt installations- - - - -	13
652 A-20	Lock Washer, 5/16 inch, for "Electro Drive" attaching bolts on "V" belt installations- - - - -	13
652 B-16	Shake-proof Lock Washer, 1/4 inch, for idler pulley bracket stove bolt on nonsubmerged installations with "Electro Drive" - - - - -	13
652 B-24	Shake-proof Lock Washer, 3/8 inch, for "Electro Drive" attaching bolts- - - - -	13
652 C-16	Shake-proof Lock Washer, for upper and lower looper connecting rod ball joints- - - - -	13
660-92	Washer, leather, 3/16 inch hole, for top of glass tube on main oil reservoir sight gauge	13
660-93	Washer, leather, 1/4 inch hole, for bottom of glass tube on main oil reservoir sight gauge	13
660-112	Spring and Catch, for tray No. 21376 H- - - - -	20
660-127	Isolated Insulator Height Adjusting Felt Washer (set of 8), for "II" installation- - -	14

LIST OF PARTS

Symbol to Order By	The figures in the last column refer only to the plates illustrating the parts and are not to be used in ordering. Refer to insert for prices.	Plate No.
660-128	Screw Eye, 1 1/4 inches long, for knee press assembly No. 21691- - - - -	13
666-1	Elbow Oil Cup, for main shaft bearing - - - - -	14
666-11	Oil Cup, for main oil reservoir on Styles 39200 J, 39300 A, 39300 B - - - - -	14
666-24	Elbow Oil Cup, for idler pulley shaft on American Safety Table installation- - - - -	14
666-31	Felt Wicking, including spring, for main shaft bearing - - - - -	14
666-37	Needle Bar Connection Link Wick (screw No. 22560)- - - - -	14
666-46	Lower Looper Rock Shaft Oil Cup - - - - -	14
666-49	Glass Tube, for main oil reservoir sight gauge	14
666-50	Oil Cup, for main oil reservoir cover - - - - -	14
666-61	" Tube, for idler pulley on round belt "Electro Drive" installations - - - - -	28
*666-79	" Cup Assembly, with sight feed and signal stop- - - - -	28
668-7	" " " for tension thread eyelet - - - - -	16
668-9	Thread Tube, porcelain, 7/8 inch long, for lower looper thread - - - - -	16
668-12	Porcelain Thread Eyelet Locking Ferrule, for tension thread eyelets- - - - -	16
668-13	Porcelain Thread Eyelet Locking Ferrule, for upper looper thread take-up eyelet- - - - -	16
668-14	Porcelain Thread Eyelet Locking Ferrule, for oil reservoir covers- - - - -	16
Y676	Expansion Reamer, for main shaft, size .437 inch- - - - -	38
719	Set Screw, for front upper looper lever shaft renewable bearing - - - - -	12
753	Tape Reel Axle Collar, for Style 39200 AJ (thumbscrew No. 188 D)- - - - -	22
907	Upper Looper Connecting Rod Ball Joint Locking Stud Nut; also for Nos. 29481, 39236 B, 39289 R, 43232- - - - -	14
3336	Needle Thread Tension Disc Separator Spring, for Style 39200 AW- - - - -	21
8372	Differential Feed Control Lever Stop, for Styles 39200 AN, 39200 AQ, 39200 AR - - - - -	14
8372 A	Differential Feed Control Lever Stop Screw Washer; also for Nos. 39243 G, 39303, 39303 B	13

*See Page 9

LIST OF PARTS

Symbol to Order By	The figures in the last column refer only to the plates illustrating the parts and are not to be used in ordering. Refer to insert for prices.	Plate No.
9271	Knee Press Shaft Collar, for knee press No. 21691 (screw No. 98) - - - - -	22
9274	Cloth Plate Pivot Pin, for Style 39100 V (screw No. 531) - - - - -	26
9937	Differential Feed Adjusting Arm Nut; also for No. 39236 H - - - - -	14
11638 M	Cloth Plate Locking Stud Nut, for Style 39200 AW - - - - -	14
12538	Upper Knife Lever Ball Joint Nut; also for No. 23441 - - - - -	14
12935 A	Lock Screw, for overhanging guide hinge block on Style 39200 AS - - - - -	11
12957 E	Spring Washer, for sewing line welt guide on Style 39200 AW; also for No. K57190 - - - - -	13
12990	Idler Pulley Shaft Arm Support Nut, for semi-submerged round belt line assembly installations - - - - -	14
14077	Nut, for cloth plate socket plate attaching screw on Style 39200 AW - - - - -	14
15498 E	Grinder Head, for knife grinder No. 39298 - - - - -	29
15498 G	Swinging Frame Pivot Pin, for knife grinder No. 39298 (friction washer screw No. 93 A) - - - - -	25
15498 H	Sewing Line Welt Guide Slide Friction Washer, for Styles 39200 AS, 39200 AV; also for No. 15498 G (attaching screw No. 22594, lock screw No. 22743) - - - - -	21
15498 J	Swinging Frame Adjusting Sleeve, for knife grinder No. 39298 (clamp screw No. 136) - - - - -	25
15498 K	Swinging Frame Adjusting Thumbscrew, for knife grinder No. 39298 - - - - -	25
15498 L	Swinging Frame Stop Pin, for knife grinder No. 39298 - - - - -	26
15498 N	Knife Positioning Lever, for knife grinder No. 39298 (screw No. 86) - - - - -	20
15498 P	Dust Guard, for knife grinder No. 39298 (screw No. 22570) - - - - -	29
16161 L	Idler Pulley Fibre Washer, for idler assembly	13
16238 H	Belt Guard Shim Washer, for Styles 39300 A, 39300 B - - - - -	13
21104 B-5	Belt Take-up Hanger Pivot Shaft, 5 inches long, for "V" belt installations (set screw No. 22627 A) - - - - -	35
21104 B-9	Thread Stand Rod, 9 inches long (set screw, square head, No. 22509, set screw, headless, No. 22591) - - - - -	35
21104 B-20	Tape Reel Vertical Rod, 20 inches long, for Style 39200 AJ (set screw No. 22509) - - - - -	35
21104 H	Base Plate Support Screw Nut, for semi-submerged installations - - - - -	14
21113 A	Thread Stand Wire Extension, 6 inches long (set screw No. 22632 F-24) - - - - -	25
21113 B	Thread Stand Wire Coupling (screw No. 88) - - - - -	19

LIST OF PARTS

Symbol to Order By	The figures in the last column refer only to the plates illustrating the parts and are not to be used in ordering. Refer to insert for prices.	Plate No.
21114 A	Thread Stand Base and Tape Reel Base (screw No. 22591)-----	39
21130 A-2	" " Seat, two spools (set screw No. 69 FD)-----	40
21130 A-3	" " Seat, three spools (set screw No. 69 FD)-----	40
21145	Cone, wood, for thread stand-----	31
21201	Screw Driver, 9/64 inch round blade, length overall 7 5/8 inches-----	38
21202	" " 7/32 inch round blade, length overall 11 1/4 inches-----	38
21203	" " 13/64 inch round blade, length overall 15 1/2 inches-----	38
21204	" " 9/32 inch round blade, length overall 15 inches-----	38
21205 A	" " 3/8 inch round blade, length overall 14 inches-----	38
21207	" " 7/64 inch round blade, length overall 2 1/2 inches-----	31
21208	Screw Driver Set, three detachable blades-----	38
21217 A	Tape Reel Axle Support, for Style 39200 AJ (thumbscrew No. 22728)-----	19
21220 C	Tape Reel Axle, 13 1/16 inches long, for Style 39200 AJ (thumbscrew No. 188 D)-----	39
21225-1/8	Looper Adjusting Gauge, 1/8 inch measurement	20
21227 HH	Porcelain Eyelet Replacement Tool Set, for assembling 1/16 inch internal diameter porcelain eyelet No. 668-7 and aluminum ferrule No. 668-12 in tension thread eyelet assembly. Ferrules should always be replaced-----	28
21227 HK	Porcelain Eyelet Replacement Tool Set, for assembling 1/8 inch internal diameter porcelain eyelets No. 668-1 and aluminum ferrules No. 668-14 in thread eyelet assemblies. Ferrules should always be replaced-----	28
21236	Belt Plier, for 3/8 inch and smaller round belt-----	38
21260	Emery Cord, 3/64 inch diameter, grade No. 120, fifty yard spool-----	---
21260 A	" " 3/64 inch diameter, grade No. 150, fifty yard spool-----	---
21260 B	" " 1/32 inch diameter, grade No. 180, fifty yard spool-----	---
21260 C	" " .025 inch diameter, grade No. 200, fifty yard spool-----	---
21260 D	" Tape, 3/32 inch wide, grade No. 180, fifty yard spool-----	---
21260 E	" Cord, .018 inch diameter, grade No. 200, fifty yard spool-----	---

LIST OF PARTS

Symbol to Order By	The figures in the last column refer only to the plates illustrating the parts and are not to be used in ordering. Refer to insert for prices.	Plate No.
21262 D-66	Leather Belt, round, 3/8 inch diameter, 66 inches long, for connecting line shaft pulley and transmitter; includes belt hook No. 21351 A - - - - -	---
21262 E-50	Leather Belt, round, 1/4 inch diameter, 50 inches long, for connecting transmitter and machine on open line shaft table; includes belt hook No. 21351 B - - - - -	---
21262 E-72	Leather Belt, round, 1/4 inch diameter, 72 inches long, for connecting transmitter and machine on American Safety Table; includes belt hook No. 21351 B - - - - -	---
21262 H-320	"V" Belt, No. 2 size, 32 inches outside circumference, for connecting "Electro Drive" and machine on "V" belt installations- - - - -	34
21262 H-330	"V" Belt, 33 inches outside circumference	34
21262 H-340	" " 34 inches outside circumference	34
21262 H-390	" " 39 inches outside circumference	34
21262 H-400	" " 40 inches outside circumference	34
21300 B-2 1/2	Carriage Bolt, 3/8 x 2 1/2 inches, for attaching belt take-up and hanger to table on "V" belt installations- - - - -	13
21300 B-4	Carriage Bolt, 3/8 x 4 inches, for attaching "Electro Drive" to table on round belt installations - - - - -	13
21351	Wire Belt Hook, for 9/32 inch round belt	20
21351 A	" " " for 3/8 inch round belt- -	20
21351 B	" " " for 1/4 inch round belt- -	20
21355	Chair Leg Extension, 4 inches long - - - -	31
21365 A	Stove Bolt, flat head, 1/4 x 2 1/4 inches, for idler pulley bracket support plate on nonsubmerged line assembly installations- - - - -	13
21369 C	Spring, for tray No. 21376 G - - - - -	28
21369 D	Spring Catch, for tray No. 21376 G - - - -	28
21371 Q	Table Drawer - - - - -	---
21371 BT-42	Blank Table Top, 42" x 16" x 1 3/4 inches	---
21371 BV-42	Table Top, 42" x 16" x 1 3/4 inches, for semisubmerged round belt open line shaft installations- - - - -	---
21371 BV-48	Table Top, 48 inches long- - - - -	---
21371 BV-60	" " 60 inches long- - - - -	---
21371 BW-42	" " 42" x 16" x 1 3/4 inches, for semisubmerged American Safety Table installations - - - - -	---
21371 BW-48	" " 48 inches long- - - - -	---

LIST OF PARTS

Symbol to Order By	The figures in the last column refer only to the plates illustrating the parts and are not to be used in ordering. Refer to insert for prices.	Plate No.
21371 HQ	Cover Strip, wood, for oil drain on non-submerged isolated "Electro Drive" "V" belt installations - - - - -	

LIST OF PARTS

Symbol to Order By	The figures in the last column refer only to the plates illustrating the parts and are not to be used in ordering. Refer to insert for prices.	Plate No.
*21375 AB	Belt Guard Assembly, for installations on American Safety Table and Singer Safety Table having two line shafts (screw No. HA 61 D)- - - - -	39
21375 AP	Belt Guard, for nonsubmerged isolated "Electro Drive" "V" belt installations- - -	39
21376 G	Tray, bakelite, 3 11/16 inches high, for nonsubmerged installations (spring No. 21369 C, spring catch No. 21369 D)- - -	39
21376 H	Tray, 1 7/16 inches high, for semisubmerged installations (spring and catch No. 660-112)- - - - -	39
*21376 J	Tray, right, including belt guard, for semisubmerged American Safety Table installations - - - - -	39
21388	Wrench, single end, 3/8 inch opening- - -	31
21388 N	" double end, 3/16 and 5/16 inch openings- - - - -	31
21388 R	" double end, 3/8 and 1/2 inch openings- - - - -	31
21388 U	" single end, 3/4 inch opening, for needle bar bearing nut- - - - -	31
21388 V	" for lower looper connecting rod ball joint- - - - -	31
21388 AF	" for stitch regulating stud nut on Styles 39200 J, 39300 A, 39300 B- -	31
21394 G	Emery Wheel, 5 inches diameter, 1/4 inch face, 3/8 inch hole, grade "M" emery 60	—
21394 H	Emery Wheel, 5 inches diameter, 1/2 inch face, 3/8 inch hole, grade "M" emery 60	—
21394 K	Utility Grinder, including emery wheel, 5 inches diameter, 1/2 inch face, round belt drive, recommended speed 3000 R.P.M.	—
21398 T	Idler Pulley, for round belt "Electro Drive" installations; also for installations on American Safety Table and Singer Safety Table having two line shafts - - -	30
21398 U	Idler Pulley Bushing, bronze- - - - -	22
21398 V	" " Shaft Leather Wiper- - - - -	14
21398 AG	Idler Pulley Shaft (plug screw No. 22586, set screw No. 22591, leather wiper No. 21398 V)- - - - -	26
21657 E	Washer, for edge guide assembly on Style 39200 AN- - - - -	13
21661	Shaft, for knee press assembly No. 21691- -	34
21662	Bracket, for knee press assembly No. 21691	33

*See Page 9

LIST OF PARTS

Symbol to Order By	The figures in the last column refer only to the plates illustrating the parts and are not to be used in ordering. Refer to insert for prices.	Plate No.
21664	Plate, for knee press assembly No. 21691 (set screw No. 69 FD) - - - - -	33
21665	Rod Connection, for knee press assembly No. 21691 (set screw No. 69 FD) - - - - -	33
21677	Plate Rod, for knee press assembly No. 21691 (set screw No. 69 FD) - - - - -	34
21679	Chain Rod, for knee press assembly No. 21691 (set screw No. 69 FD) - - - - -	35
21680 AA	Base Plate, for nonsubmerged, isolated, installations on American Safety Table and Singer Safety Table having two line shafts- -	33
21680 AF	Base Plate, for semisubmerged, isolated, installations on American Safety Table and Singer Safety Table with two line shafts- - -	33
21680 AL	Base Plate, for semisubmerged, isolated, round belt installations on line assembly individual power table - - - - -	34
21680 AM	Base Plate, for nonsubmerged, isolated, round belt installations on line assembly individual power table - - - - -	35
21680 AQ	Base Plate, for semisubmerged, isolated, "V" belt installations- - - - -	34
21680 AR	Base Plate, for nonsubmerged, isolated, "Electro Drive" "V" belt installations- - -	34
21691	Knee Press Assembly, for operating differential feed on Styles 39200 AN, 39200 AQ, 39200 AR; also operating retractable guide on Style 39200 AV; one each Nos. 421 C-10, 660-128, 21661, 21662, 21664, 21677, 21679, 28504; two each Nos. 9271, 21665. Specify component parts in ordering - - - - -	35
21697 A	Mounting Bracket, for round belt "Electro Drive" installations- - - - -	33
21697 U	Belt Take-up and Hanger Assembly, for "V" belt "Electro Drive" installations; one each Nos. 21104 B-5, 21697 V, 21697 W, 22627 A; two each Nos. 22649 X-96, 28509 B; three each Nos. 650 G-12, 652 A-20 - - - - -	39
21697 V	Belt Take-up and Hanger, lower section- - - - -	—
21697 W	" " " " upper section- - - - -	—
22503	Set Screw, for lifter lever arm - - - - -	11
22515	Clamp Screw, hexagonal head, for presser foot on Styles 39200 E, 39200 K- - - - -	11
22516	Screw, for feed rocker segment slot plate - - -	12
22517	" for upper looper rocker clamp- - - - -	12
22524	" countersunk head, for throat plates- - -	11
22526	" for socket plate on Style 39200 AW - - -	11

LIST OF PARTS

Symbol to Order By	The figures in the last column refer only to the plates illustrating the parts and are not to be used in ordering. Refer to insert for prices.	Plate No.
22528	Screw, for feed dog holder on Styles 39100 C, 39100 M, 39100 N, 39100 S, 39100 V, 39200 B, 39200 C, 39200 F, 39200 G, 39200 J, 39200 L, 39200 Q, 39200 R, 39300 A, 39300 B; also for Nos. 39150 V, 39250 B- - - - -	12
22537	Screw, for upper knife lever pivot stud- - - - -	12
22542	" for presser spring tube clamp; also for Nos. 39155 A, 39156, 39157 J- - - - -	11
22548	Pivot Screw, for edge guide assembly on Style 39200 AN - - - - -	12
22559 B	Screw, for pulley rim on Style 39200 J equipped with "V" belt- - - - -	12
22560	Screw, for needle bar connection link wick - - -	11
22560 A	" for cloth plate pivot pin, when pin journals in bed - - - - -	11
22560 B	" for main feed bar on Styles 39200 AA, 39200 AC, 39200 AD, 39200 AE, 39200 AH, 39200 AJ, 39200 AN, 39200 AQ, 39200 AR, 39200 AS, 39200 AT, 39200 AU, 39200 AV, 39200 AW- - - - -	11
22561	" fillister head, for throat plate; also for No. 23446 - - - - -	11
22570	" for dust guard on knife grinder No. 39298	11
22570 A	Screw, for throat plate support on styles in Class 39100; also Styles 39200 B, 39200 C, 39200 E, 39200 F, 39200 G, 39200 J, 39200 K, 39200 L, 39200 Q, 39200 R, 39200 AA, 39200 AC, 39200 AD, 39200 AE, 39200 AH, 39200 AJ, 39200 AN, 39200 AQ, 39200 AR, 39200 AU, 39200 AW, 39300 A, 39300 B - - - - -	11
22571 B	Plug Screw, for sight feed oiler hole in main oil reservoir- - - - -	11
22580	Plug Screw, for looper lever shaft; also for No. 39147- - - - -	11
22581	Screw, for tape tension on Style 39200 AJ- - -	12
22585	" for needle bar cross head guide block; also for Nos. 39125 A, 39198 F- - - - -	11
22586	Plug Screw, front, for upper looper rock shaft; also for No. 21398 AG- - - - -	11
22586 A	Plug Screw, rear, for upper looper rock shaft- -	11
22587 E	Screw, for main shaft eccentric bearing- - - -	12
22588 A	" fillister head, for cloth plate spring on machines equipped with cloth plate No. 39201 - - - - -	12
22591	Set Screw, for thread stand rods; also for Nos. 21114 A, 21398 AG, 39195, 39195 A, 39198 E - -	11
22593	Screw, for differential feed bar guide plate - -	11
22594	Attaching Screw, for sewing line welt guide slide friction washer on Styles 39200 AS, 39200 AV - - - - -	11
22596	Screw, fillister head, for oil drain support; also for Nos. 39150 V, 39236 J, 39250 B- - - -	12

LIST OF PARTS

Symbol to Order By	The figures in the last column refer only to the plates illustrating the parts and are not to be used in ordering. Refer to insert for prices.	Plate No.
22597	Spot Screw, for pulleys Nos. 39221, 43221-	12
22597 A	Set Screw, for pulley No. 39221-	11
22627 A	" " for belt take-up hanger pivot shaft	12
22632 F-24	Set Screw, square head, cup point, 3/16 inch diameter, 3/8 inch long, 24 threads to inch, for thread stand wire; also for No. 21113 A-	11
22649 K-96	Adjusting Screw, square head, 5/16 inch diameter, 1 1/2 inches long, 18 threads to inch, for belt take-up hanger (nut No. 23509 B)	13
22707	Pivot Screw, hexagonal head, for sewing line welt guide slide swinging support on Style 39200 AS; also for Nos. 29481, 43232	12
22711	Screw, for front cover	11
22726 A	Pivot Screw, for swing-out gauge on assembly No. K57194	11
22728	Thumbscrew for tape reel axle on Style 39200 AJ	12
22733	Stop Screw, for overhanging guide hinge block on Style 39200 AS-	11
22733 A	Plug Screw, for cloth plate pivot screw hole on Style 39100 V	11
22738	Screw, for presser foot bottom spring on Styles 39100 C, 39100 S, 39100 V, 39200 C, 39200 F, 39200 G, 39200 J, 39200 L, 39200 Q, 39200 R, 39200 AC, 39200 AD, 39200 AQ, 39200 AR, 39200 AS, 39200 AT, 39200 AU, 39200 AV, 39300 A, 39300 B; also for No. 39130 D-	11
22743	Screw, for differential feed bar guide on Styles 39200 AA, 39200 AC, 39200 AD, 39200 AE, 39200 AH, 39200 AJ, 39200 AN, 39200 AQ, 39200 AR, 39200 AS, 39200 AT, 39200 AU, 39200 AV, 39200 AW; also for Nos. 15498 H, K57186	11
22747	Screw, for lower looper connecting rod ball joint fork; also for Nos. 39144 V, 39289 J, 41255 B	11
22748	Adjusting Screw, for overhanging guide on Styles 39200 AS, 39200 AT, 39200 AV-	11
22758	Pivot Stud, for needle thread tension disc separator on Style 39200 AW; also for No. K57191	11
22764	Spot Screw, for main shaft eccentrics-	11
22766	Screw, for overhanging guide on Style 39100S	11

LIST OF PARTS

Symbol to Order By	The figures in the last column refer only to the plates illustrating the parts and are not to be used in ordering. Refer to insert for prices.	Plate No.
22768	Screw, 7/32 inch long, for upper looper rocker thread eyelet, right, on Styles 39100 C, 39100 M, 39100 N, 39100 S, 39100 V, 39200 K, 39200 L, 39200 Q, 39200 AH, 39200 AN; also for Nos. 52 A, 39103 A, 39103 V- - - - -	11
22773	Stud, for sewing line welt guide support on Style 39200 AW - - - - -	12
22791 A	Screw Pin, 1 1/8 inches long, cone point, for main shaft crank pin on styles in Classes 39100, 39300 - - - - -	12
22791 B	Screw Pin, 1 9/32 inches long, cone point, for main shaft crank pin on styles in Class 39200	12
22799 B	Hinge Screw, for overhanging guide on Style 39200 AU - - - - -	12
22799 F	Hinge Screw, for presser feet; also for No. 39189 A- - - - -	11
22799 J	Hinge Screw, for overhanging guide hinge block on Styles 39200 AS, 39200 AT, 39200 AV - - - -	12
22812	Screw, for knife positioning lever on knife grinder No. 39298- - - - -	11
22813	Set Screw, headless, for lifter treadle pin- - -	11
22823 A	Screw, hexagonal head, for attaching machines to metal base plate - - - - -	12
22829	Side Screw, for sheet metal cloth plates - - - -	11
22841	Thumbscrew, for adjusting differential feed on Styles 39200 E, 39200 K- - - - -	13
22841 A	Socket Stud, for adjusting differential feed on Styles 39200 E, 39200 K- - - - -	12
22842	Screw, for lower knife holder on Styles 39100 C, 39100 M, 39100 N, 39100 S, 39200 B, 39200 C, 39200 E, 39200 F, 39200 G, 39200 J, 39200 K, 39200 L, 39200 Q, 39200 R, 39200 AA, 39200 AC, 39200 AD, 39200 AE, 39200 AH, 39200 AJ, 39200 AN, 39200 AQ, 39200 AR, 39200 AU, 39200 AW; also for No. 39250 - - - - -	12
22843	Presser Spring Regulating Screw- - - - -	12
22845 A	Stud, for retractable guide operating lever on Style 39200 AV - - - - -	11
22845 B	Guide Screw, for sewing line welt guide slide on Styles 39200 AS, 39200 AT, 39200 AV- - - - -	11
22848	Screw, for side cover; also for Nos. 39162 C, 39162 G, 39162 J, 43281 J- - - - -	11
22849	Screw, for needle bar cover; also for Nos. 39165 B, 39189 B, 39289 T, K55510- - - - -	11
22856	Hinge Screw, for presser foot yielding section on Styles 39200 E, 39200 K; also for No. 39130 L- - - - -	11
22862	Attaching Screw, for overhanging guide on Styles 39200 AS, 39200 AT, 39200 AV; also for Nos. 39103 A, 39103 V, 39150 T, 39203 AU, K50132- -	11
22868	Screw, for regulating differential feed on Styles 39200 AN, 39200 AQ, 39200 AR- - - - -	12

LIST OF PARTS

Symbol to Order By	The figures in the last column refer only to the plates illustrating the parts and are not to be used in ordering. Refer to insert for prices.	Plate No.
22871	Screw, for base plate on semisubmerged in- stallations- - - - -	25
22873	Thumbscrew, for adjusting welt guide slide on Styles 39200 AS, 39200 AT, 39200 AV; also for No. K57190 - - - - -	12
23144 B	Sewing Line Welt Guide Slide Swinging Support Spring Washer, for Styles 39200 AS, 39200AT, 39200 AV - - - - -	13
23425	Washer Plate, for edge guide on Style 39200 AU	20
23441	Edge Guide Assembly, for Style 39200 AN; one each Nos. 12538, 21657 E, 22548, 23441 A, 23441 B, 23441 C, 23441 D, 23441 E - - - - -	27
23441 A	Swinging Arm, for assembly No. 23441 (pivot screw No. 22548) - - - - -	27
23441 B	Swinging Arm Support, for assembly No. 23441 (screw No. 93 A) - - - - -	26
23441 C	Swinging Arm Spring, for assembly No. 23441-	21
23441 D	" " Bushing, for assembly No. 23441	13
23441 E	" " Pivot Screw Washer, for assembly No. 23441 - - - - -	13
23446	Fabric Guide Plate, for Styles 39200 AS, 39200 AT, 39200 AV (screw No. 22561) - - - - -	30
28505	Chain Arm Spring, for knee press assembly No. 21691- - - - -	22
28509 B	Lock Nut, for adjusting screw on belt take-up and hanger - - - - -	14
28577	Washer, for sewing line welt guide support on Style 39200 AW - - - - -	13
*29126 A	Upper Looper and Spreader Eccentric Assembly; includes eccentric No. 39146, throw .276 inch (set screw No. 88, spot screw No. 22764, bearing screw No. 22587 E) - - - - -	23
*29126 G	Lower Looper Eccentric Assembly; includes eccentric No. 39148, throw .276 inch (set screw No. 88, spot screw No. 22764, bearing screw No. 22587 E) - - - - -	23
*29126 N	Feed Rocker Eccentric Assembly; includes eccentric No. 39140 D, throw .066 inch, for Styles 39100 C, 39100 M, 39100 N, 39100 S, 39100 V, 39200 B, 39200 C, 39200 E, 39200 F, 39200 G, 39200 K, 39200 L, 39200 Q (set screw No. 88, spot screw No. 22764, bearing screw No. 22587 E) - - - - -	23
*29126 P	Feed Rocker Eccentric Assembly; includes eccentric No. 39340, throw .140 inch, for Styles 39200 J, 39200 AA, 39200 AC, 39200AD, 39200 AE, 39200 AH, 39200 AJ, 39200 AN, 39200 AQ, 39200 AR, 39200 AU, 39200 AW, 39300 A, 39300 B (set screw No. 88, spot screw No. 22764, bearing screw No. 22587 E)	23

LIST OF PARTS

Symbol to Order By	The figures in the last column refer only to the plates illustrating the parts and are not to be used in ordering. Refer to insert for prices.	Plate No.
#29126 U	Feed Lift Eccentric Assembly; includes eccentric No. 39106, throw .066 inch, for Styles 39100 C, 39100 M, 39100 N, 39100 S, 39100 V (set screw No. 88, spot screw No. 22764, bearing screw No. 22587 E) - - - - -	24
#29126 V	Feed Lift Eccentric Assembly; includes eccentric No. 39306, throw .080 inch, for Styles 39300 A, 39300 B (set screw No. 88, spot screw No. 22764, bearing screw No. 22587 E)	24
#29126 W	Feed Lift Eccentric Assembly; includes eccentric No. 39206, throw .110 inch, for Styles 39200 B, 39200 C, 39200 E, 39200 F, 39200 G, 39200 K, 39200 L, 39200 Q, 39200 R, 39200 AA, 39200 AC, 39200 AD, 39200 AE, 39200 AH, 39200 AJ, 39200 AN, 39200 AQ, 39200 AR, 39200 AS, 39200 AT, 39200 AV, 39200 AW (set screw No. 88, spot screw No. 22764, bearing screw No. 22587 E) - - - - -	24
#29126 X	Feed Rocker Eccentric Assembly; includes eccentric No. 39240 H, throw .110 inch, for Styles 39200 AS, 39200 AT, 39200 AV (set screw No. 88, spot screw No. 22764, bearing screw No. 22587 E) - - - - -	24
#29126 Z	Feed Lift Eccentric Assembly; includes eccentric No. 39206 A, throw .110 inch, for Style 39200 J (set screw No. 88, spot screw No. 22764, bearing screw No. 22587 E) - - - - -	24
#29126 AB	Feed Rocker Eccentric Assembly; includes eccentric No. 39140 R, throw .023 inch, for Style 39200 R (set screw No. 88, spot screw No. 22764, bearing screw No. 22587 E) - - - - -	24
29402	Lifter Treadle Assembly; one each Nos. 422, 423, 424, 22813 - - - - -	33
29459 C	Feed Assembly, for styles equipped with wrench adjustment front tandem differential feed; one each Nos. 97, 531, 39135, 39135 G, 39135 N, 39234, 39234 A, 39236 B, 39236 C, 39236 U, 39236 V, 39237, 39238 A, 39239, 39240, 39240 D, 39240 E; two each Nos. 907, 22743, 39236 A, 39237 D; three No. 22516 and four No. 22593) - - - - -	30
29470 L	Idler Assembly and Base Plate, for nonsubmerged group isolated installation on American Safety Table and Singer Safety Table having two line shafts; one each Nos. 660-127, 21262 E-72, 21375 AB, 21680 AA; two each Nos. 666-24, 21398 T, 21398 AG, 39153 G, 39195, 39195 A; three No. 22823 A; four each Nos. HA 61 D, 16161 L, 22591, 51295 - - - - -	36

#See Page 9

LIST OF PARTS

Symbol to Order By	The figures in the last column refer only to the plates illustrating the parts and are not to be used in ordering. Refer to insert for prices.	Plate No.
29470 M	Idler Assembly and Base Plate, for semisubmerged group isolated installation on American Safety Table and Singer Safety Table having two line shafts; one each Nos. 93, 21262 E-72, 21376 J, 21680 AF, 33189 C; two each Nos. 666-24, 21398 T, 21398 AG, 39153 G, 39195, 39195 A; three No. 22823 A; four each Nos. 16161 L, 22591, 22871, 51295; eight No. 21104 H - - -	36
29470 P	Adjustable Idler Assembly and Base Plate, for nonsubmerged, round belt "Electro Drive" installations on line assembly individual power table; one each Nos. 666-61, 21398 T, 21398AG, 21680 AM, 21697 A, 39153 G, 39195, 39195 A, 39195 B; two each Nos. 652 B-16, 16161 L, 21365 A, 22591; three each Nos. 650 G-10, 652-20, 652 B-24, 21300 B-4, 22823 A; four No. 51295- - - - -	37
29470 Q	Adjustable Idler Assembly and Base Plate, for semisubmerged round belt "Electro Drive" installations on line assembly individual power table; one each Nos. 666-61, 12990, 21398 T, 21398 AG, 21680 AL, 21697 A, 39195, 39195 A; two each Nos. 16161 L, 22591; three each Nos. 650 G-10, 652-20, 652 B-24, 21300 B-4, 22823 A; four each Nos. 22871, 51295; eight No. 21104 H - - -	37
29470 X	Transmission Accessories Assembly, for semi-submerged isolated "V" belt installation; one No. 21680 AQ; three each Nos. 652-24, 21300 B-2 1/2, 22823 A; four each Nos. 22871, 51295; eight No. 21104 H - - - - -	-
29470 Y	Transmission Accessories Assembly, for non-submerged isolated "Electro Drive" "V" belt installations; one each Nos. 21680 AR, 21371 HQ, 21375 AP, 43294 C, 43294 F; two No. 652-12; three each Nos. 652-24, 652 B-24, 21300 B-2 1/2, 22823 A, 51295- - - - -	-
29477	Lower Looper Eccentric Connecting Rod Assembly; one each Nos. 29126 G, 18, 269, 39144, 39145 E. Assembly is set to gauge before shipment. The approximate distance between centers is 4 31/64 inches - - - - -	23
29477 F	Upper Looper and Spreader Eccentric Connecting Rod Assembly, for styles in Class 39200; one each Nos. 29126 A, 18, 269, 22747, 39144, 39144 V, 43243 H. Assembly is set to gauge before shipment. The approximate distance between centers is 4 15/32 inches. This measurement is vital, as any error will alter the travel of the upper looper or spreader - - -	23

LIST OF PARTS

Symbol to Order By	The figures in the last column refer only to the plates illustrating the parts and are not to be used in ordering. Refer to insert for prices.	Plate No.
29477 G	Feed Rocker Eccentric Connecting Rod Assembly, for Styles 39200 AA, 39200 AC, 39200 AD, 39200 AE, 39200 AH, 39200 AJ, 39200 AN, 39200 AQ, 39200 AR, 39200 AU, 39200 AW; one each Nos. 29126 P, 18, 269, 22747, 39241, 41255 B, 43241 D. Assembly is set to gauge before shipment. The approximate distance between centers is 4 13/64 inches - - - - -	23
29477 H	Feed Lift Eccentric Connecting Rod Assembly, for Styles 39200 B, 39200 C, 39200 E, 39200 F, 39200 G, 39200 K, 39200 L, 39200 Q, 39200 R, 39200 AA, 39200 AC, 39200 AD, 39200 AE, 39200 AH, 39200 AJ, 39200 AN, 39200 AQ, 39200 AR, 39200 AS, 39200 AT, 39200 AV, 39200 AW; one each Nos. 29126 W, 18, 269, 39175, 39274 N. Assembly is set to gauge before shipment. The approximate distance between centers is 2 1/16 inches - - - - -	24
29477 J	Feed Rocker Eccentric Connecting Rod Assembly, for Styles 39100 C, 39100 N, 39100 S, 39200 E, 39200 F, 39200 G, 39200 K, 39200 L, 39200 Q; one each Nos. 29126 N, 18, 269, 22747, 39141, 41255 B, 43241 D. Assembly is set to gauge before shipment. The approximate distance between centers is 4 inches - - - - -	23
29477 K	Feed Rocker Eccentric Connecting Rod Assembly, for Style 39200 J; one each Nos. 29126 P, 18, 269, 22747, 39141, 41255 B, 43241 D. Assembly is set to gauge before shipment. The approximate distance between centers is 4 inches - - - - -	23
29477 L	Feed Rocker Eccentric Connecting Rod Assembly, for Styles 39200 AS, 39200 AT, 39200 AV; one each Nos. 29126 X, 18, 269, 22747, 39241, 41255 B, 43241 D. Assembly is set to gauge before shipment. The approximate distance between centers is 4 7/32 inches - - - - -	23
29477 M	Feed Rocker Eccentric Connecting Rod Assembly, for Styles 39300 A, 39300 B; one each Nos. 29126 P, 18, 269, 22747, 39141, 41255 B, 43241 D. Assembly is set to gauge before shipment. The approximate distance between centers is 3 61/64 inches - - - - -	23
29477 N	Feed Lift Eccentric Connecting Rod Assembly, for Styles 39100 C, 39100 M, 39100 N; one each Nos. 29126 U, 18, 269, 39174 U, 39175. Assembly is set to gauge before shipment. The approximate distance between centers is 2 3/32 inches - - - - -	24

LIST OF PARTS

Symbol to Order By	The figures in the last column refer only to the plates illustrating the parts and are not to be used in ordering. Refer to insert for prices.	Plate No.
29477 Q	Feed Lift Eccentric Connecting Rod Assembly, for Style 39200 J; one each Nos. 29126 Z, 18, 269, 39174 U, 39175. Assembly is set to gauge before shipment. The approximate distance between centers is 2 3/32 inches- - - -	24
29477 R	Feed Lift Eccentric Connecting Rod Assembly, for Styles 39300 A, 39300 B; one each Nos. 29126 V, 18, 269, 39174 U, 39175. Assembly is set to gauge before shipment. The approximate distance between centers is 2 1/16 inches- - - -	24
29477 S	Feed Rocker Eccentric Connecting Rod Assembly, for Style 39200 R; one each Nos. 29126 AB, 18, 269, 22747, 39141, 41255 B, 43241 D. Assembly is set to gauge before shipment. The approximate distance between centers is 4 1/32 inches - - - -	23
29477 AB	Upper Looper and Spreader Eccentric Connecting Rod Assembly, for Styles 39100 C, 39100 M, 39100 N, 39100 S, 39300 A, 39300 B; one each Nos. 29126 A, 18, 269, 22747, 39144, 39144 V, 43243 H. Assembly is set to gauge before shipment. The approximate distance between centers is 4 29/64 inches - - - -	24
29481	Edge Guide Assembly, with retractable lever, for Style 39200 AV; one each Nos. 86, 15498H, 22594, 22743, 22845 A, 22873, 39289 G, 39289 N, 39289 P, 39289 Q, 39289 R; two each Nos. 90, 22845 B (pivot screw No. 22707, nut No. 907, spring washer No. 23144 B) - - - -	26
29481 A	Overhanging Guide Support Assembly, for Style 39200 AU; one each Nos. 187 B, 22799 B, 39289 T, 39289 U, 39289 V - - - -	27
35178 G	Sewing Line Welt Guide Stop Nut, for Styles 39200 AS, 39200 AT, 39200 AV- - - -	14
35587 B	Cloth Plate Spring, for Styles 39200 AS, 39200 AT, 39200 AV (screw No. 187 B)- - - -	21
35737 A	Sewing Line Welt Guide Slide Support Bushing, for Styles 39200 AS, 39200 AT, 39200 AV - - -	19
35755 E	Stitch Regulating Ball Stud Washer, for Style 39100 V - - - -	13
39101 A	Cloth Plate, for Styles 39100 S, 39200 AU - - -	40
39103 A	Sewing Line Hem Guide, for Style 39100 S (attaching screw No. 22768, adjusting screw No. 22862)- - - -	20
39103 V	Sewing Line Welt Guide, for Style 39100 V (attaching screw No. 22768, adjusting screw No. 22862)- - - -	20
39105 C	Feed Dog, for Styles 39100 C, 39100 M, 39100 N	4

LIST OF PARTS

Symbol to Order By	The figures in the last column refer only to the plates illustrating the parts and are not to be used in ordering. Refer to insert for prices.	Plate No.
39105 F	Feed Dog, for Styles 39200 B, 39200 G, 39200 R	4
39105 Q	" " for Style 39200 Q - - - - -	5
39105 T	" " for Style 39100 S - - - - -	5
	Feed Dog Screw No. 93	
39108	Looper, upper, for Styles 39100 C, 39100 N (screw No. 77) - - - - -	10
39108 A	Looper, lower, for styles in Classes 39100, 39300 (screw No. 77) - - - - -	10
39113	Upper Looper Rocker and Spreader Rocker - - - - -	24
39117	Needle Bar, .257 inch diameter, includes clamp nut No. 39151 - - - - -	25
39120 B	Presser Foot Assembly, hinged bottom, for Style 39100 C-3/32; one each Nos. 39130 C, 91, 604, 22799 F, 39130, 39130 A, 39130 D, 39297 AD; two No. 22738 - - - - -	7
39120 C	Presser Foot Assembly, hinged bottom, for Styles 39100 C-1/8, 39200 C; one each Nos. 39130 C, 91, 604, 22799 F, 39130, 39130 A, 39130 D, 39297 AC; two No. 22738 - - - - -	7
39120 G	Presser Foot Assembly, hinged bottom, for Style 39200 G; one each Nos. 39130 F, 91, 604, 22799 F, 39130, 39130 A, 39197 G; two No. 22738 - - - - -	7
39120 M	Presser Foot Assembly, rigid bottom, for Styles 39100 M, 39100 N; one each Nos. 39130 M, 73 A, 91, 604, 39130 D, 39197 M - - - - -	7
39120 R	Presser Foot Assembly, hinged bottom, for Style 39200 R; one each Nos. 39130 F, 91, 604, 22799 F, 39130, 39130 A, 39197 R; two No. 22738 - - - - -	6
39120 T	Presser Foot Assembly, hinged bottom, for Style 39100 S; one each Nos. 39130 R, 91, 604, 22799 F, 39130, 39130 A, 39130 D, 39197 T; two No. 22738 - - - - -	6
39121	Pulley, grooved for round belt, working diameter 2 1/4 inches (spot screw No. 96, set screw No. 98) - - - - -	30
39122	Main Shaft, including crank pin, for styles in Classes 39100, 39300 - - - - -	32
39124 C	Throat Plate, for Styles 39100 C-1/8, 39200 C-1/8 (screw No. 22561) - - - - -	1
39124 D	Throat Plate, for Style 39100 C-3/32 (screw No. 22561) - - - - -	1
39124 F	" " for Style 39200 B (screw No. 22561) - - - - -	1

LIST OF PARTS

Symbol to Order By	The figures in the last column refer only to the plates illustrating the parts and are not to be used in ordering. Refer to insert for prices.	Plate No.
39124 G	Throat Plate, for Style 39200 G (screw No. 22561)	1
39124 P	" " for Styles 39100 M, 39100 N (screw No. 22561) - - - - -	1
39124 R	" " for Style 39200 R (screw No. 22561)	1
39124 T	" " for Style 39100 S (screw No. 22561)	1
39124 V	" " for Style 39100 V (screw No. 22524)	3
39125	Lower Knife Holder Needle Guard, front (screw No. 97) - - - - -	16
39125 A	Frame Needle Guard, rear (screw No. 22585) - - -	16
39130	Presser Foot Shank, for Styles 39100 C-3/32, 39100 C-1/8, 39100 S, 39100 V, 39200 B, 39200 C, 39200 F, 39200 G, 39200 J, 39200 L, 39200 Q, 39200 R, 39200 AA, 39200 AE, 39200 AH, 39200 AJ, 39200 AN, 39200 AR, 39200 AU, 39300 A, 39300 B (clamp screw No. 91) - - - - -	-
39130 A	Presser Foot Bottom Spring, for Styles 39100 C-3/32, 39100 C-1/8, 39100 S, 39100 V, 39200 C, 39200 F, 39200 G, 39200 J, 39200 L, 39200 Q, 39200 R, 39200 AC-3/32, 39200 AC-1/8, 39200 AD-3/32, 39200 AD-1/8, 39200 AU, 39300 A, 39300 B (screw No. 22738) - - - - -	10
39130 C	Presser Foot Bottom, for Styles 39100 C-3/32, 39100 C-1/8, 39200 C-1/8 (hinge screw No. 22799 F) - - - - -	7
39130 D	Presser Foot Chain Guard, for Styles 39100 C-3/32, 39100 C-1/8, 39100 M, 39100 N, 39100 S, 39100 V, 39200 C, 39200 F, 39200 L, 39200 AS, 39200 AT, 39200 AV (screw No. 22738)	9
39130 F	Presser Foot Bottom, for Styles 39200 G, 39200 R (hinge screw No. 22799 F) - - - - -	7
39130 G	Presser Foot Yielding Section Spring, for Styles 39200 E, 39200 K - - - - -	21
39130 H	Presser Foot Yielding Section, for Styles 39200 E, 39200 K (screw No. 22856) - - - - -	10
39130 J	Presser Foot Yielding Section Regulating Pin, for Styles 39200 E, 39200 K (set screw No. 77)	9
39130 L	Presser Foot Yielding Section Lever, for Styles 39200 E, 39200 K (screw No. 22856) - - - - -	10
39130 M	Presser Foot Main Section, for Styles 39100 M, 39100 N (clamp screw No. 91) - - - - -	8
39130 T	Presser Foot Bottom, for Style 39100 S (hinge screw No. 22799 F) - - - - -	8
39130 V	Presser Foot Bottom, for Style 39100 V (hinge screw No. 22799 F) - - - - -	8
39130 AC	Presser Foot Shank, for Styles 39200 AC-3/32, 39200 AC-1/8, 39200 AD-3/32, 39200 AD-1/8 (clamp screw No. 91) - - - - -	-
39132 V	Cloth Plate Spring Pin, for Style 39100 V - - - - -	19
39134	Main Feed Bar, for Styles 39200 E, 39200 K (screw No. 89) - - - - -	32

LIST OF PARTS

Symbol to Order By	The figures in the last column refer only to the plates illustrating the parts and are not to be used in ordering. Refer to insert for prices.	Plate No.
39134 A	Differential Feed Bar, for Styles 39200 E, 39200 K- - - - -	22
39134 B	Feed Bar, for Styles 39100 C, 39100 M, 39100 N, 39100 S, 39100 V, 39200 B, 39200 C, 39200 F, 39200 G, 39200 J, 39200 L, 39200 Q, 39200 R, 39300 A, 39300 B (screw No. 89)- - - - -	32
39135	Feed Bar Shaft, standard diameter .319 inch (screw No. 531)- - - - -	26
39135-322	" " " standard diameter plus .003 inch - - - - -	-
39135-328	" " " standard diameter plus .009 inch - - - - -	-
39135 G	Feed Lift Link Stud (screw No. 89) - - - - -	19
39135 N	Feed Bar Spacing Collar, for Styles 39200 AA, 39200 AC, 39200 AD, 39200 AE, 39200 AH, 39200 AJ, 39200 AN, 39200 AQ, 39200 AR, 39200 AS, 39200 AT, 39200 AU, 39200 AV, 39200 AW - - - - -	19
39136 N	Differential Feed Adjusting Arm, for Styles 39200 E, 39200 K (nut No. 9937)- - - - -	18
39136 Q	Differential Feed Lever Bushing, for Styles 39200 E, 39200 K - - - - -	19
39136 U	Differential Feed Adjusting Arm Lever, for Styles 39200 E, 39200 K- - - - -	24
39137	Differential Feed Bar Swivel, for Styles 39200 E, 39200 K - - - - -	18
39138	Feed Lift Link, for Styles 39100 C, 39100 M, 39100 N, 39100 S, 39100 V, 39300 A, 39300 B	24
39139	Feed Dog Holder, for Styles 39100 C, 39100 M, 39100 N, 39100 S, 39100 V, 39200 E, 39200 C, 39200 F, 39200 G, 39200 J, 39200 L, 39200 Q, 39200 R, 39300 A, 39300 B (screw No. 93 A)	22
39140	Feed Rocker, for Styles 39100 C, 39100 M, 39100 N, 39100 S, 39100 V, 39200 B, 39200 C, 39200 E, 39200 F, 39200 G, 39200 J, 39200 K, 39200 L, 39200 Q, 39200 R, 39300 A, 39300 B	22
39140 U	Feed Rocker Shaft Bushing, 7/8 inch long - - -	19
39140 V	" " " " 1 1/4 inches long	19
39141	Feed Rocker Eccentric Connecting Rod, for Styles 39100 C, 39100 M, 39100 N, 39100 S, 39100 V, 39200 B, 39200 C, 39200 E, 39200 F, 39200 G, 39200 J, 39200 K, 39200 L, 39200 Q, 39200 R, 39300 A, 39300 B (nut, right thread No. 18, nut, left thread No. 269)- - - - -	25
39141 G	Stitch Regulating Ball Joint Stud Nut, for Style 39100 V- - - - -	14

LIST OF PARTS

Symbol to Order By	The figures in the last column refer only to the plates illustrating the parts and are not to be used in ordering. Refer to insert for prices.	Plate No.
39142 A	Upper Looper Rock Shaft, 4 5/16 inches long, with oil hole, 3/16 inch diameter (plug screw, front, No. 22586, plug screw, rear, No. 22586 A) - - - - -	19
39142 G	Upper Looper Rock Shaft Bushing, 21/32 inch long (screw No. 531) - - - - -	19
39142 H	Upper Looper Lever Shaft Bushing (screw, front, No. 719, screw, rear, No. 531) - - -	19
39142 J	Upper Looper Rocker Clamp (screw No. 22517)	24
39142 N	" " " Link - - - - -	24
39143 G	" " Lever Shaft (plug screw No. 22580) - - - - -	25
39144	Upper and Lower Looper Connecting Rod (nut, left thread No. 18, nut, right thread No. 269) - - - - -	25
39144 U	Lower Looper Connecting Rod Ball Joint Fork (screw No. 22747) - - - - -	18
39144 V	Upper Looper Connecting Rod Ball Joint Fork (screw No. 22747) - - - - -	18
*39145 E	Lower Looper Connecting Rod Ball Joint (bearing screw No. 97 A, attaching nut No. 258A, attaching washer No. 652 C-16) - - - - -	18
*39145 G	Stitch Regulating Ball Joint, for Style 39100 V (bearing screw No. 97 A, ball stud washer No. 35755 E, nut No. 39141 G) - - - -	18
39147	Lower Looper Rock Shaft (plug screw No. 22580)	22
39147 D	" " " " Collar (screw No. 88)	14
39147 G	" " " " Bushing, front, 9/16 inch long - - - - -	19
39147 N	" " " " Bushing, rear, 11/16 inch long - - - - -	19
39150 V	Lower Knife Holder, for Style 39100 V (attaching screw No. 22596, set screw No. 22528) - - - - -	17
39152	Needle Bar Cross Head (screw No. 88) - - - - -	18
39152 N	Needle Bar Cross Head Guide Block (screw No. 22585) - - - - -	18
39152 U-4	Needle Bar Cross Head Guide Block Shim, .004 inch thick - - - - -	22
39152 U-5	Needle Bar Cross Head Guide Block Shim, .005 inch thick - - - - -	22
39152 U-6	Needle Bar Cross Head Guide Block Shim, .006 inch thick - - - - -	22
39152 U-7	Needle Bar Cross Head Guide Block Shim, .007 inch thick - - - - -	22
39152 U-8	Needle Bar Cross Head Guide Block Shim, .008 inch thick - - - - -	22

*See Page 9

LIST OF PARTS

Symbol to Order By	The figures in the last column refer only to the plates illustrating the parts and are not to be used in ordering. Refer to insert for prices.	Plate No.
39152 U-9	Needle Bar Cross Head Guide Block Shim, .009 inch thick - - - - -	22
39153 G	Needle Bar Bearing Nut; also for No. 39195 A	14
39155	Lifter Lever, for machines equipped for round belt (stop pin No. 42 A) - - - - -	22
39155 D	Lifter Lever Bushing, 1 29/32 inches long - -	26
39155 N	Lifter Lever Spring - - - - -	21
39156	Presser Arm (screw No. 22542) - - - - -	32
39157	Presser Spring- - - - -	21
39157 G	" " Plunger- - - - -	26
39157 H	" " Tube, including nuts - - - - -	25
39157 J	" " Tube Clamp (screw No. 22542)	19
39157 K	" " " Nut - - - - -	14
39158 G	" " Hinge; also for No. 39258 - - - - -	26
39158 N	" " Hinge Pin - - - - -	25
39158 U	" " Spring- - - - -	21
39160	Spreader, for Styles 39100 M, 39100 S, 39100V, 39300 A, 39300 B (screw No. 77) - - - - -	10
39161	Frame Slide, front, for styles equipped with two loopers - - - - -	30
39161 A	Frame Slide, rear; also frame slide, front, for styles equipped with one looper - - - - -	30
39162	Needle Bar Cover, bakelite (screw No. 22849)	30
39162 C	Belt Guard (screw, 11/32 inch long No. 22848, screw, 7/16 inch long No. 93) - - - - -	40
*39162 J	Oil Reservoir and Top Cover, for Styles 39200 J, 39300 A, 39300 B (screw No. 22848)	34
39162 N	Side Cover, bakelite, for styles in Classes 39100, 39200 (screw No. 22848) - - - - -	40
39162 U	Oiling Tube, for knife bar bearing (screw No. 531) - - - - -	14
39162 NA	Side Cover, bakelite, for Style 39300 A (screw No. 22848) - - - - -	40
39162 NB	Side Cover, bakelite, for Style 39300 B (screw No. 22848) - - - - -	40
*39163	Front Needle Thread Eyelet (attaching screw No. 90, porcelain insert No. 668-7, insert ferrule No. 668-12- - - - -	26

*See Page 9

LIST OF PARTS

Symbol to Order By	The figures in the last column refer only to the plates illustrating the parts and are not to be used in ordering. Refer to insert for prices.	Plate No.
39163 G	Frame Needle Thread Eyelet, for Styles 39100 C, 39100 M, 39100 S, 39100 V, 39300 A, 39300 B (screw No. 90) - - - - -	15
39164	Needle Bar Link Thread Guide, for Styles 39100 C, 39100 M, 39100 S, 39100 V, 39300 A, 39300 B (screw No. 87 U) - - - - -	15
*39165	Oil Reservoir Cover and Lead-in Thread Eyelet, for Style 39100 V (porcelain insert No. 668-1, insert ferrule No. 668-14, screw No. 87 U) - - - - -	28
*39165 A	Oil Reservoir Cover and Lead-in Thread Eyelet, for Styles 39200 J, 39300 A, 39300 B (porcelain insert No. 668-1, insert ferrule No. 668-14, screw No. 222 D) - - - - -	28
*39165 B	Oil Reservoir Cover and Lead-in Thread Eyelet, for Styles 39100 C, 39100 M, 39100 N, 39100 S, 39200 B, 39200 C, 39200 E, 39200 F, 39200 G, 39200 J, 39200 K, 39200 L, 39200 Q, 39200 R, 39200 AA, 39200 AC, 39200 AD, 39200 AE, 39200 AH, 39200 AJ, 39200 AN, 39200 AQ, 39200 AR, 39200 AS, 39200 AT, 39200 AU, 39200 AV (screw No. 22849) - - - - -	28
39166	Looper Thread Tube, double, for styles using two looper threads (screw No. 94) - - - - -	26
39166 U	Looper Thread Tube, single, for styles using one looper thread (screw No. 94) - - - - -	26
*39167	Looper Thread Pull-off Eyelet, for Styles 39100 C, 39100 N, 39200 B, 39200 C, 39200 E, 39200 F, 39200 G, 39200 J, 39200 K, 39200 Q, 39200 R, 39200 AC, 39200 AE, 39200 AH, 39200 AJ, 39200 AN, 39200 AQ, 39200 AR, 39200 AS, 39200 AT, 39200 AV, 39200 AW (porcelain insert No. 668-7, insert ferrule No. 668-13, screw No. 90) - - - - -	15
39167 G	Looper Thread Pull-off, for Styles 39100 C, 39100 M, 39200 B, 39200 C, 39200 E, 39200 F, 39200 G, 39200 J, 39200 K, 39200 L, 39200 Q, 39200 R, 39200 AC, 39200 AE, 39200 AH, 39200 AJ, 39200 AN, 39200 AQ, 39200 AR, 39200 AS, 39200 AT, 39200 AV, 39200 AW (screw No. 87 U) - - - - -	15
39168	Upper Looper Rocker Thread Eyelet, right, two eyes, for upper and lower looper threads on Styles 39100 C, 39100 N, 39200 B, 39200 C, 39200 E, 39200 F, 39200 G, 39200 J, 39200 K, 39200 L, 39200 Q, 39200 R, 39200 AC, 39200 AE, 39200 AH, 39200 AJ, 39200 AN, 39200 AQ, 39200 AR, 39200 AT, 39200 AW (screw No. 22768) - - - - -	15

*See Page 9

LIST OF PARTS

Symbol to Order By	The figures in the last column refer only to the plates illustrating the parts and are not to be used in ordering. Refer to insert for prices.	Plate No.
#39168 G	Upper Looper Thread Take-up Eyelet, for styles equipped with two loopers (screw No. 90, porcelain insert No. 668-7, insert ferrule No. 668-13)-----	15
39168 Q	Upper Looper Thread Take-up, with elongated thread slot, for Styles 39100 N, 39200 B, 39200 C, 39200 E, 39200 F, 39200 G, 39200 J, 39200 K, 39200 L, 39200 Q, 39200 R, 39200AC, 39200 AE, 39200 AH, 39200 AJ, 39200 AN, 39200 AQ, 39200 AR, 39200 AS, 39200 AT, 39200 AV, 39200 AW (screw No. 87 U)-----	15
39168 V	Spreader Rocker Thread Eyelet, right, one eye, for looper thread on Styles 39100 M, 39100S, 39100 V, 39200 J, 39200 AA, 39200 AD, 39200 AS, 39200 AT, 39200 AV, 39300 A, 39300 B (screw No. 87 U)-----	16
39168 X	Lower Looper Thread Take-up, with round thread eye, for Styles 39100 C, 39100 N, 39100 S, 39200 B, 39200 C, 39200 E, 39200 F, 39200 G, 39200 L, 39200 R, 39200 AC, 39200 AE, 39200 AH, 39200 AJ, 39200 AQ, 39200 AR, 39200 AW (screw No. 87 U)-----	15
39168 Y	Frame Looper Thread Take-up Eyelet, for Style 39100 V (porcelain insert No. 668-7, insert ferrule No. 668-12)-----	16
39168 Z	Lower Looper Thread Take-up, for Styles 39100 M, 39100 N, 39100 S, 39100 V, 39200 J, 39200 K, 39200 L, 39200 Q, 39200 AA, 39200 AD, 39200 AN, 39200 AU, 39300 A, 39300 B (screw No. 87 U)-----	16
39171	Upper Knife Holder, for Styles 39100 S, 39100 V, 39200 AU, 39200 AW-----	17
39171 N	Upper Knife Spring Adjusting Collar (screw No. 77)-----	14
39171 R	Upper Knife Spring Adjusting Collar Guide Pin	19
39173	Upper Knife Spring, .031 inch diameter wire, for Styles 39100 C, 39100 M, 39100 N, 39100 S, 39100 V-----	21
39173 A	Upper Knife Spring, .039 inch diameter wire, for styles in Class 39200-----	21
39174	Upper Knife Lever-----	32
39174 G	" " " Pivot Stud-----	19
39174 P	Upper Knife Lever Ball Joint Washer, for Styles 39100 C, 39100 M, 39100 N, 39100 S, 39100 V, 39200 J, 39300 A, 39300 B-----	13

LIST OF PARTS

Symbol to Order By	The figures in the last column refer only to the plates illustrating the parts and are not to be used in ordering. Refer to insert for prices.	Plate No.
*39174 U	Upper Knife Lever Ball Joint, for Styles 39100 C, 39100 M, 39100 N, 39100 S, 39100 V, 39200 J, 39300 A, 39300 B (bearing screw No. 97 A, nut No. 12538)-	18
39175 G	Oiling Tube, 1 1/2 inches long, for knife lever ball joint - - - - -	14
39178	Fabric Guard, for Styles 39100 C, 39100 M, 39100 N, 39100 S, 39200 B, 39200 C, 39200 E, 39200 F, 39200 G, 39200 J, 39200 K, 39200 L, 39200 Q, 39200 R, 39200 AA, 39200 AC, 39200 AD, 39200 AE, 39200 AH, 39200 AJ, 39200 AN, 39200 AQ, 39200 AR, 39200 AU, 39200 AW, 39300 A, 39300 B (screw No. 73 A) - - - - -	28
39178 V	Fabric Guard, for Styles 39100 V, 39200AS, 39200 AT, 39200 AV (screw No. 73 A) - - -	28
39179	Lower Looper Tension Post Thread Eyelet, horizontal - - - - -	15
39180	Throat Plate Support, for Styles 39100 C, 39100 M, 39100 N, 39100 S, 39200 B, 39200 C, 39200 E, 39200 F, 39200 G, 39200 J, 39200 K, 39200 L, 39200 Q, 39200 R, 39200 AA, 39200 AC, 39200 AD, 39200 AE, 39200 AH, 39200 AJ, 39200 AN, 39200 AQ, 39200 AR, 39200 AU, 39200 AW (screw No. 22570 A) - - - - -	28
39180 G	Throat Plate Dowel Pin, 7/32 inch long - -	19
39180 V	" " Support, for Style 39100 V (screw No. 136) - - - - -	27
39180 W	" " Support Dowel Pin, for Style 39100 V - - - - -	19
39189-1/2	Overhanging Guide, for 1/2 inch hem on Style 39100 S- - - - -	27
39189-3/4	Overhanging Guide, for 3/4 inch hem- - - -	27
39189-7/8	" " for 7/8 inch hem- - - -	27
39189 A	Overhanging Guide Screw No. 22766 Overhanging Guide Hinge Block, for Style 39100 S (adjusting screw No. 79077, hinge screw No. 22799 F) - - - - -	20
39189 B	Overhanging Guide Hinge Block Support, for Style 39100 S (screw No. 22849)- - - - -	20
39189 C	Overhanging Guide Hinge Block Support Screw Plate, for Styles 39100 S, 39200AU	20
39190	Main Shaft Bushing, front, 57/64 inch long	19
39190 G	" " " rear, 1 17/64 inches long - - - - -	19

*See Page 9

LIST OF PARTS

Symbol to Order By	The figures in the last column refer only to the plates illustrating the parts and are not to be used in ordering. Refer to insert for prices.	Plate No.
39191 G	Main Shaft Crank Pin (screw pin No. 22791 A, for styles in Classes 39100, 39300; screw pin No. 22791 B for styles in Class 39200)- -	19
39193	Main Oil Reservoir Sight Gauge Assembly; one each Nos. 660-92, 660-93, 666-49, 39193 A, 39193 B - - - - -	20
39193 A	Main Oil Reservoir Sight Gauge Glass Tube Cover	20
39193 B	" " " " " Base - - - - -	20
39195	Idler Pulley Shaft Arm, for American Safety-Table installations; also nonsubmerged round belt "Electro Drive" installations on line assembly individual power tables (screw No. 22591)- - - - -	25
39195 A	Idler Pulley Shaft Arm Support, for round belt installations (screw No. 22591, nut No. 39153 G)- - - - -	25
39195 B	Idler Pulley Bracket Support Plate, for non-submerged round belt "Electro Drive" installations on line assembly individual power tables (bolt No. 21365 A, washer No.652 B-16)	30
39197 G	Presser Foot Tongue, marked "BL", for Style 39200 G - - - - -	9
39197 M	Presser Foot Tongue, marked "BZ", for Styles 39100 M, 39100 N- - - - -	9
39197 R	Presser Foot Tongue, marked "BT", for Style 39200 R - - - - -	9
39197 T	Presser Foot Tongue, marked "BP", for Styles 39100 S, 39100 V- - - - -	9
39198 C	Presser Foot Tongue Screw No. 604 Knife Positioning Lever, for knife grinder No. 39298 (screw No. 22812) - - - - -	29
39198 D	Knife Positioning Lever Spring Washer, for knife grinder No. 39298 - - - - -	13
39198 E	Swinging Frame, for knife grinder No. 39298 (screw No. 22591) - - - - -	29
39198 F	Swinging Frame Top Plate, for knife grinder No. 39298 (screw No. 22585) - - - - -	29
39199 H	Tape Tension, for Style 39200 AJ (screw No. 22581)- - - - -	28
39201	Cloth Plate, steel, for nonsubmerged installations of Styles 39100 C, 39100 M, 39100 N, 39200 B, 39200 C, 39200 E, 39200 F, 39200 G, 39200 J, 39200 K, 39200 L, 39200 R, 39200 AA, 39200 AC, 39200 AD, 39200 AE, 39200 AH, 39200 AJ, 39200 AQ, 39300 A, 39300 B (side screw No. 22829 - - - - -	40

LIST OF PARTS

Symbol to Order By	The figures in the last column refer only to the plates illustrating the parts and are not to be used in ordering. Refer to insert for prices.	Plate No.
39201 A	Cloth Plate, steel, for semisubmerged installations of Styles 39100 C, 39100 M, 39100 N, 39200 B, 39200 C, 39200 E, 39200 F, 39200 G, 39200 J, 39200 K, 39200 L, 39200 R, 39200 AA, 39200 AC, 39200 AD, 39200 AE, 39200 AH, 39200 AJ, 39200 AQ, 39300 A, 39300 B (side screw No. 22829) - - - - -	40
39201 AN	Cloth Plate, for nonsubmerged installation of Styles 39200 AN, 39200 AR (side screw No. 22829) - - - - -	40
39201 AR	Cloth Plate, for semisubmerged installation of Styles 39200 AN, 39200 AR (side screw No. 22829) - - - - -	40
39201 AS	Cloth Plate, for Styles 39200 AS, 39200 AT, 39200 AV (side screw No. 22829, spring No. 35587 B, spring screw No. 187 B) - - - - -	40
39203 J	Cloth Gauge Assembly, for Style 39200 J; one each Nos. 28, 39203 K, 39203 L - - - - -	27
39203 K	Edge Guide, for gauge assembly No. 39203 J - - - - -	27
39203 L	Top Guide, for gauge assembly No. 39203 J (screw No. 28) - - - - -	20
39203 AU	Edge Guide, for welt on Style 39200 AU (adjusting screw No. 22862, attaching screw No. 57 WD) - - - - -	20
39205 A	Feed Dog, for Styles 39200 F, 39200 L (screw No. 93) - - - - -	4
39205 E	Main Feed Dog, for Style 39200 E (screw No. 93 A) - - - - -	4
39205 J	Feed Dog, for Style 39200 J (screw No. 93) - - - - -	4
39205 AC	Main Feed Dog, for Styles 39200 AC, 39200 AD (screw No. 94) - - - - -	5
39205 AH	Main Feed Dog, for Styles 39200 AA, 39200 AE, 39200 AH, 39200 AJ, 39200 AU (screw No. 94) - - - - -	5
39205 AN	Main Feed Dog, for Style 39200 AN (screw No. 94) - - - - -	5
39205 AQ	" " " for Style 39200 AQ (screw No. 94) - - - - -	5
39205 AR	" " " for Style 39200 AR (screw No. 94) - - - - -	5
39205 AS	" " " for Styles 39200 AS, 39200 AT, 39200 AV (screw No. 94) - - - - -	5
39208	Looper, upper, for Styles 39200 E, 39200 K (screw No. 77) - - - - -	10
39208 B	Looper, upper, for Styles 39200 B, 39200 C, 39200 F, 39200 G, 39200 Q, 39200 R, 39200 AC, 39200 AE, 39200 AH, 39200 AJ, 39200 AN, 39200 AQ, 39200 AR; 39200 AT, 39200 AW (screw No. 77) - - - - -	10
39208 L	Looper, upper, for Style 39200 L (screw No. 77) - - - - -	10

LIST OF PARTS

Symbol to Order By	The figures in the last column refer only to the plates illustrating the parts and are not to be used in ordering. Refer to insert for prices.	Plate No.
39208 AA	Looper, lower, for Styles 39200 B, 39200 C, 39200 E, 39200 F, 39200 G, 39200 J, 39200 K, 39200 Q, 39200 R, 39200 AA, 39200 AC, 39200 AD, 39200 AE, 39200 AH, 39200 AJ, 39200 AN, 39200 AR, 39200 AS, 39200 AT, 39200 AU, 39200 AV (screw No. 77) - - - - -	10
39209 L	Looper, lower, for Style 39200 L (screw No. 77)	10
39220	Presser Foot Assembly, hinged bottom, for Styles 39200 AA, 39200 AH; one each Nos. 39230 B, 91, 604, 22799 F, 39130, 39297 AH -	6
39220 B	Presser Foot Assembly, hinged bottom, for Style 39200 B; one each Nos. 39230 AE, 91, 604, 22799 F, 39130, 39297 AC - - - - -	8
39220 E	Presser Foot Assembly, hinged bottom, for Style 39200 E; one each Nos. 39230 E, 77, 91, 604, 22515, 22799 F, 22856, 39130 G, 39130 H, 39130 J, 39130 L, 39230, 39230 A, 39297 E - -	8
39220 F	Presser Foot Assembly, hinged bottom, for Styles 39200 F, 39200 L; one each Nos. 39230 F, 91, 604, 22799 F, 39130, 39130 A, 39130 D, 39297 F; two No. 22738 - - - - -	6
39220 J	Presser Foot Assembly, hinged bottom, for Style 39200 J; one each Nos. 39230 C, 91, 22799 F, 39130, 39130 A, 39230 J, 39297 J; two each Nos. 604, 22738 - - - - -	7
39220 K	Presser Foot Assembly, hinged bottom, for Style 39200 K; one each Nos. 39230 K, 77, 91, 604, 22515, 22799 F, 22856, 39130 G, 39130 H, 39130 J, 39130 L, 39230, 39230 A, 39297 K - -	8
39220 Q	Presser Foot Assembly, hinged bottom, for Style 39200 Q; one each Nos. 39230 Q, 91, 604, 22799 F, 39130, 39130 A, 39297 Q; two No. 22738 - - - - -	6
39220 AC	Presser Foot Assembly, hinged bottom, for Styles 39200 AC-1/8, 39200 AD-1/8, 39200 AQ; one each Nos. 39230 AE, 91, 604, 22738, 22799 F, 39130 A, 39130 AC, 39297 AC - - - -	7
39220 AD	Presser Foot Assembly, hinged bottom, for Styles 39200 AC-3/32, 39200 AD-3/32; one each Nos. 39230 AE, 91, 604, 22738, 22799 F, 39130 A, 39130 AC, 39297 AD - - - - -	7
39220 AE	Presser Foot Assembly, hinged bottom, for Style 39200 AE; one each Nos. 39230 AE, 91, 604, 22799 F, 39130, 39297 E - - - - -	6
39220 AH	Presser Foot Assembly, hinged bottom, for Style 39200 AJ; one each Nos. 39230 AH, 91, 604, 22799 F, 39130, 39297 AH - - - - -	6
		7

LIST OF PARTS

Symbol to Order By	The figures in the last column refer only to the plates illustrating the parts and are not to be used in ordering. Refer to insert for prices.	Plate No.
39220 AR	Presser Foot Assembly, hinged bottom, for Style 39200 AR; one each Nos. 39230 AR, 91, 604, 22738, 22799 F, 39130, 39230 G, 39230 M, 39297 AC; two No. 91 A- - - - -	8
39220 AS	Presser Foot Assembly, hinged bottom, for Styles 39200 AS, 39200 AT, 39200 AV; one each Nos. 39230 AS, 73 A, 91, 604, 22738, 22799 F, 39130 D, 39230 C, 39281, 39297 AS- - - - -	8
39222	Main Shaft, including crank pin, for styles in Class 39200 - - - - -	32
39224	Throat Plate, for Styles 39200 AH, 39200AJ	2
39224 A	" " for Styles 39200 F, 39200 L	2
39224 B	" " for Style 39200 E - - - - -	2
39224 J	" " for Style 39200 J - - - - -	2
39224 K	" " for Style 39200 K - - - - -	3
39224 Q	" " for Style 39200 Q - - - - -	2
39224 AC-3/32	" " for Styles 39200 AC-3/32, 39200 AD-3/32 - - - - -	3
39224 AC-1/8	" " for Styles 39200 AC-1/8, 39200 AD-1/8, 39200 AQ- - - - -	3
39224 AE	" " for Style 39200 AE- - - - -	3
39224 AN	" " for Style 39200 AN- - - - -	2
39224 AR	" " for Style 39200 AR- - - - -	3
39224 AU	" " for Style 39200 AU- - - - -	3
39226 E	Throat Plate Screw No. 22561 Differential Feed Dog, for Styles 39200E, 39200 K (screw No. 93 A)- - - - -	5
39226 AC-3/32	Differential Feed Dog, for Styles 39200 AC-3/32, 39200 AD-3/32 (screw No. 94) - - - - -	4
39226 AC-1/8	Differential Feed Dog, for Styles 39200 AC-1/8, 39200 AD-1/8 (screw No. 94) - - - - -	4
39226 AE	Differential Feed Dog, for Style 39200 AE (screw No. 94)- - - - -	4

LIST OF PARTS

Symbol to Order By	The figures in the last column refer only to the plates illustrating the parts and are not to be used in ordering. Refer to insert for prices.	Plate No.
39226 AH	Differential Feed Dog, for Styles 39200 AA, 39200 AH, 39200 AJ (screw No. 94) - - - - -	4
39226 AN	Differential Feed Dog, for Style 39200 AN (screw No. 94) - - - - -	4
39226 AQ	Differential Feed Dog, for Style 39200 AQ (screw No. 94) - - - - -	5
39226 AR	Differential Feed Dog, for Style 39200 AR (screw No. 94) - - - - -	5
39226 AS	Differential Feed Dog, for Styles 39200 AS, 39200 AT, 39200 AV (screw No. 94) - - - - -	4
39226 AU	Differential Feed Dog, for Style 39200 AU (screw No. 94) - - - - -	4
39228 AS	Throat Plate, for Styles 39200 AS, 39200 AT, 39200 AV (screw No. 22524) - - - - -	3
39230	Presser Foot Shank, for Styles 39200 E, 39200 K (clamp screw No. 91) - - - - -	-
39230 A	Presser Foot Bottom Spring, for Styles 39200 E, 39200 K (screw No. 22515) - - - - -	10
39230 B	Presser Foot Bottom, for Styles 39200 AA, 39200 AH (hinge screw No. 22799 F) - - - - -	9
39230 C	Presser Foot Shank, for Styles 39200 AS, 39200 AT, 39200 AV, 39200 AW (clamp screw No. 91) - - - - -	-
39230 E	Presser Foot Bottom, for Style 39200 E (hinge screw No. 22799 F) - - - - -	7
39230 F	Presser Foot Bottom, for Styles 39200 F, 39200 L (hinge screw No. 22799 F) - - - - -	9
39230 G	Presser Foot Stripper Blade, for Style 39200AR (screw No. 91 A) - - - - -	10
39230 J	Presser Foot Extension, right, for Style 39200 J (screw No. 604) - - - - -	10
39230 K	Presser Foot Bottom, for Style 39200 K (hinge screw No. 22799 F) - - - - -	8
39230 Q	Presser Foot Bottom, for Style 39200 Q (hinge screw No. 22799 F) - - - - -	9
39230 AE	Presser Foot Bottom, for Styles 39200 B, 39200 AC-3/32, 39200 AC-1/8, 39200 AD-3/32, 39200 AD-1/8, 39200 AE (hinge screw No. 22799 F) - - - - -	9
39230 AH	Presser Foot Bottom, for Style 39200 AJ (hinge screw No. 22799 F) - - - - -	9
39230 AN	Presser Foot Bottom, for Style 39200 AN (hinge screw No. 22799 F) - - - - -	7
39230 AR	Presser Foot Bottom, for Style 39200 AR (hinge screw No. 22799 F) - - - - -	8
39230 AS	Presser Foot Bottom, for Styles 39200 AS, 39200 AT, 39200 AV (hinge screw No. 22799 F)	9

LIST OF PARTS

Symbol to Order By	The figures in the last column refer only to the plates illustrating the parts and are not to be used in ordering. Refer to insert for prices.	Plate No.
39230 AU	Presser Foot Bottom, for Style 39200 AU (hinge screw No. 22799 F) - - - - -	8
*39234	Main Feed Bar, for Styles 39200 AA, 39200 AC, 39200 AD, 39200 AE, 39200 AH, 39200 AJ, 39200 AN, 39200 AQ, 39200 AR, 39200 AS, 39200 AT, 39200 AU, 39200 AV (screw No. 22560 B) - - - - -	32
39234 A	Differential Feed Bar, for Styles 39200 AA, 39200 AC, 39200 AD, 39200 AE, 39200 AH, 39200 AJ, 39200 AN, 39200 AQ, 39200 AR, 39200 AS, 39200 AT, 39200 AU, 39200 AV - - - - -	22
39236	Differential Feed Regulating Screw Sliding Block, for Styles 39200 AN, 39200 AQ, 39200 AR - - - - -	14
39236 B	Differential Feed Regulating Stud, for Styles 39200 AA, 39200 AC, 39200 AD, 39200 AE, 39200 AH, 39200 AJ, 39200 AS, 39200 AT, 39200 AU, 39200 AV, 39200 AW (nut No. 907) - - - - -	12
39236 C	Differential Feed Regulating Stud Stop - - - - -	13
39236 G	Differential Feed Control Lever, front, for Styles 39200 AN, 39200 AQ, 39200 AR - - - - -	22
39236 H	Differential Feed Control Lever, rear, for Styles 39200 AN, 39200 AQ, 39200 AR (nut No. 9937) - - - - -	22
39236 J	Differential Feed Control Front Lever Stop Support, for Styles 39200 AN, 39200 AQ, 39200 AR (screw No. 22596) - - - - -	22
39236 L	Differential Feed Control Rear Lever Spring, for Styles 39200 AN, 39200 AQ, 39200 AR - - - - -	21
39236 N	Differential Feed Control Rear Lever Link, for Styles 39200 AN, 39200 AQ, 39200 AR - - - - -	18
39236 T	Differential Feed Driving Link, for Styles 39200 AN, 39200 AQ, 39200 AR - - - - -	24
39236 U	Differential Feed Driving Link, for Styles 39200 AA, 39200 AC, 39200 AD, 39200 AE, 39200 AH, 39200 AJ, 39200 AS, 39200 AT, 39200 AU, 39200 AV, 39200 AW - - - - -	24
39236 V	Differential Feed Control Rear Lever Link Bushing, for Styles 39200 AA, 39200 AC, 39200 AD, 39200 AE, 39200 AH, 39200 AJ, 39200 AN, 39200 AQ, 39200 AR, 39200 AS, 39200 AT, 39200 AU, 39200 AV, 39200 AW - - - - -	19
39237	Differential Feed Bar Guide, for Styles 39200 AA, 39200 AC, 39200 AD, 39200 AE, 39200 AH, 39200 AJ, 39200 AN, 39200 AQ, 39200 AR, 39200 AS, 39200 AT, 39200 AU, 39200 AV, 39200 AW (screw No. 22743) - - - - -	18

*See Page 9

LIST OF PARTS

Symbol to Order By	The figures in the last column refer only to the plates illustrating the parts and are not to be used in ordering. Refer to insert for prices.	Plate No.
39237 D	Differential Feed Bar Guide Plate, for Styles 39200 AA, 39200 AC, 39200 AD, 39200 AE, 39200 AH, 39200 AJ, 39200 AN, 39200 AQ, 39200 AR, 39200 AS, 39200 AT, 39200 AU, 39200 AV, 39200 AW (screw No. 22593)- - - - -	16
39238	Feed Lift Link, for Styles 39200 B, 39200 C, 39200 E, 39200 F, 39200 G, 39200 K, 39200 L, 39200 Q, 39200 R- - - - -	24
39238 A	Feed Lift Link, for Styles 39200 AA, 39200 AC, 39200 AD, 39200 AE, 39200 AH, 39200 AJ, 39200 AN, 39200 AQ, 39200 AR, 39200 AS, 39200 AT, 39200 AU, 39200 AV, 39200 AW- - - - -	24
39238 H	Feed Lift Link, for Style 39200 J - - - - -	24
39239	Main Feed Dog Holder, for Styles 39200 AA, 39200 AC, 39200 AD, 39200 AE, 39200 AH, 39200 AJ, 39200 AN, 39200 AQ, 39200 AR, 39200 AS, 39200 AT, 39200 AU, 39200 AV, 39200 AW (screw No. 97) - - - - -	16
39240	Feed Rocker, for Styles 39200 AA, 39200 AC, 39200 AD, 39200 AE, 39200 AH, 39200 AJ, 39200 AN, 39200 AQ, 39200 AR, 39200 AS, 39200 AT, 39200 AU, 39200 AV, 39200 AW- - - - -	22
39240 D	Feed Rocker Segment Slot Plate, for Styles 39200 AA, 39200 AC, 39200 AD, 39200 AE, 39200 AH, 39200 AJ, 39200 AS, 39200 AT, 39200 AU, 39200 AV, 39200 AW (screw No.22516)	22
39240 E	Feed Rocker Segment Slot Plate Shim, for Styles 39200 AA, 39200 AC, 39200 AD, 39200 AE, 39200 AH, 39200 AS, 39200 AT, 39200 AU, 39200 AV, 39200 AW- - - - -	18
39240 F	Feed Rocker Segment Slot Plate, for Styles 39200 AN, 39200 AQ, 39200 AR (screw No.22516)	22
39241	Feed Rocker Eccentric Connecting Rod, for Styles 39200 AA, 39200 AC, 39200 AD, 39200AE, 39200 AH, 39200 AJ, 39200 AN, 39200 AQ, 39200 AR, 39200 AS, 39200 AT, 39200 AU, 39200 AV, 39200 AW (nut, right thread, No. 18, nut, left thread, No. 269) - - - - -	25
39243	Upper Looper Lever- - - - -	22
39249 A	Lower Knife, double end, for Styles 39100 C, 39100 M, 39100 N, 39100 S, 39100 V, 39200 B, 39200 C, 39200 E, 39200 F, 39200 G, 39200 K, 39200 L, 39200 Q, 39200 R, 39200 AA, 39200 AC, 39200 AD, 39200 AE, 39200 AH, 39200 AJ, 39200 AN, 39200 AS, 39200 AT, 39200 AV, 39200 AW- - - - -	17
39249 K	Lower Knife, for Style 39200 J- - - - -	17
39249 AU	Lower Knife, for Styles 39200 AQ, 39200 AR, 39200 AU- - - - -	17

LIST OF PARTS

Symbol to Order By	The figures in the last column refer only to the plates illustrating the parts and are not to be used in ordering. Refer to insert for prices.	Plate No.
39250 A	Lower Knife Holder, for Styles 39100 C, 39100 M, 39100 N, 39200 B, 39200 C, 39200 E, 39200 F, 39200 G, 39200 J, 39200 K, 39200 L, 39200 Q, 39200 R, 39200 AA, 39200 AC, 39200 AD, 39200 AE, 39200 AH, 39200 AN, 39200 AQ, 39200 AR, 39200 AW (screw No. 22842) - - - - -	22
39250 B	Lower Knife Holder, for Styles 39200 AS, 39200 AT, 39200 AV (attaching screw No. 22596, set screw No. 22528) - - - - -	17
39250 C	Lower Knife Holder Stud, for Styles 39200 AS, 39200 AT, 39200 AV - - - - -	17
39250 H	Upper Knife Holder Stud, for Styles 39100 S, 39100 V, 39200 AU, 39200 AW; also lower knife holder stud for Styles 39100 S, 39200AU	17
39250 J	Upper and Lower Knife Holder Stud Nut - - - - -	14
39250 K	Lower Knife Holder Stud, for Styles 39100 C, 39100 M, 39100 N, 39200 B, 39200 C, 39200 E, 39200 F, 39200 J, 39200 K, 39200 L, 39200 Q, 39200 R, 39200 AA, 39200 AC, 39200 AD, 39200 AE, 39200 AH, 39200 AJ, 39200 AN, 39200 AQ, 39200 AR, 39200 AU, 39200 AV - - - - -	17
39251 AS	Lower Knife Holder Plate (screw No. 90) - - - - -	17
39252 N	Needle Bar Cross Head Guide Block, for styles in Class 39200 (screw No. 22585) - - - - -	18
39253	Needle Bar Bearing, for styles in Class 39200 (nut No. 39153 G) - - - - -	22
39258	Sheet Metal Side Cover Assembly, for Styles 39200 AS, 39200 AT, 39200 AV; one each Nos. 39158 G, 39258 A, 43261 D (screw No. 22848)	32
39258 A	Sheet Metal Side Cover, for Styles 39200 AS, 39200 AT, 39200 AV - - - - -	32
39258 C	Sheet Metal Side Cover Washer, for Styles 39200 AS, 39200 AT, 39200 AV - - - - -	13
39260	Spreader, for Styles 39200 J, 39200 AA, 39200 AD, 39200 AS, 39200 AT, 39200 AU, 39200 AV (screw No. 77) - - - - -	10
39263	Needle Thread Eyelet, front, for Style 39200 L (porcelain insert No. 668-18, insert ferrule No. 668-19, screw No. 90) - - - - -	26
39263 G	Frame Needle Thread Eyelet, for Styles 39100N, 39200 B, 39200 C, 39200 E, 39200 F, 39200 G, 39200 J, 39200 L, 39200 Q, 39200 R, 39200 AA, 39200 AC, 39200 AD, 39200 AE, 39200 AH, 39200 AJ, 39200 AN, 39200 AQ, 39200 AR, 39200 AS, 39200 AT, 39200 AU, 39200 AV, 39200 AW (screw No. 90) - - - - -	15

*See Page 9

LIST OF PARTS

Symbol to Order By	The figures in the last column refer only to the plates illustrating the parts and are not to be used in ordering. Refer to insert for prices.	Plate No.
39264	Needle Bar Link Thread Guide, for Styles 39200 B, 39200 C, 39200 E, 39200 F, 39200 G, 39200 J, 39200 R, 39200 AA, 39200 AC, 39200 AD, 39200 AE, 39200 AH, 39200 AJ, 39200 AQ, 39200 AR, 39200 AS, 39200 AT, 39200 AU, 39200 AV, 39200 AW (screw No.87 U)	15
*39266 G	Lower Loper Tension Post Thread Eyelet, vertical, for styles equipped with front tandem differential feed (porcelain insert No. 668-7, insert ferrule No. 668-12)- - - -	16
*39266 H	Lower Loper Tension Post Thread Eyelet, for Style 39200 L (porcelain insert No. 668-18, insert ferrule No. 668-19) - - - - -	16
*39267	Looper Thread Pull-off Eyelet, for Style 39200 L (porcelain insert No. 668-18, insert ferrule No. 668-20, screw No. 90)- - - - -	15
*39268	Lower Loper Tension Post Thread Eyelet, horizontal, with two porcelain eyes, for Styles 39200 AS, 39200 AT, 39200 AV - - - - -	15
39268 A	Lower Loper Thread Take-up, for Styles 39200 AS, 39200 AT, 39200 AV (screw No.87 U)	15
39268 B	Lower Loper Thread Take-up Spring, for Styles 39200 AS, 39200 AT, 39200 AV (screw No.73 A)	21
39268 C	Looper Thread Take-up Eyelet, for Style 39200L (porcelain insert No. 668-18, insert ferrule No. 668-20, screw No. 90)- - - - -	15
39270 A	Upper Knife, for Style 39200 AU- - - - -	17
39270 B	" " for Styles 39100 S, 39100 V, 39200 AW- - - - -	17
39270 D	" " for Styles 39100 C, 39100 M, 39100 N, 39200 G, 39200 Q, 39200R, 39200 AS, 39200 AT, 39200 AV- - -	17
39270 E	Upper Knife, for Styles 39200 B, 39200 C-1/8, 39200 E, 39200 F, 39200 K, 39200 L, 39200 AA, 39200 AC, 39200 AD, 39200 AE, 39200 AH, 39200 AJ, 39200 AN, 39200 AQ, 39200 AR - - -	17
39270 K		17

*See Page 9

LIST OF PARTS

Symbol to Order By	The figures in the last column refer only to the plates illustrating the parts and are not to be used in ordering. Refer to insert for prices.	Plate No.
39274 G	Upper Knife Lever Ball Joint Washer, for Styles 39200 B, 39200 C, 39200 E, 39200F, 39200 G, 39200 K, 39200 L, 39200 Q, 39200 R, 39200 AA, 39200 AC, 39200 AD, 39200 AE, 39200 AH, 39200 AJ, 39200 AN, 39200 AQ, 39200 AR, 39200 AS, 39200 AT, 39200 AU, 39200 AV, 39200 AW - - - - -	13
*39274 N	Upper Knife Lever Ball Joint, for Styles 39200 B, 39200 C, 39200 E, 39200 F, 39200 G, 39200 K, 39200 L, 39200 Q, 39200 R, 39200 AA, 39200 AC, 39200 AD, 39200 AE, 39200 AH, 39200 AJ, 39200 AN, 39200 AQ, 39200 AR, 39200 AS, 39200 AT, 39200 AU, 39200 AV, 39200 AW (screw No. 97 A, nut No. 12538) - - - - -	18
39278 A	Chip Guard, for Styles 39100 C, 39100 M, 39100 N, 39200 B, 39200 C, 39200 E, 39200 F, 39200 G, 39200 J, 39200 K, 39200 Q, 39200 R, 39200 AA, 39200 AC, 39200 AD, 39200 AE, 39200 AH, 39200 AJ, 39200 AQ, 39200 AR, 39200 AW (screw No. 42 A) - - - - -	28
39281	Presser Foot Chain Cutting Knife, for Styles 39200 AS, 39200 AT, 39200 AU, 39200 AV (screw No. 73 A) - - - - -	16
39289	Hinge Block, for overhanging guide on Styles 39200 AS, 39200 AT, 39200 AV (hinge screw No. 22799 J, stop screw No. 22733, lock screw No. 12935 A) - - - - -	16
39289 B	Sewing Line Welt Guide Slide, for Styles 39200 AS, 39200 AT (guide screw No. 22845 B, adjusting screw No. 22873) - - - - -	26
39289 G	Sewing Line Welt Guide Slide Adjusting Screw Tension Spring, for Styles 39200 AS, 39200 AT, 39200 AV (screw No. 90) - - - - -	21
39289 H-1/2	Overhanging Guide, for 1/2 inch welt on Styles 39200 AS, 39200 AT, 39200 AV - - - - -	27
39289 H-5/8	Overhanging Guide, for 5/8 inch welt - - - - -	27
39289 H-3/4	" " for 3/4 inch welt - - - - -	27
39289 H-7/8	" " for 7/8 inch welt - - - - -	27
39289 H-1	" " for 1 inch welt - - - - -	27
	Overhanging Guide Attaching Screw No. 22862	
	Overhanging Guide Adjusting Screw No. 22748	

*See Page 9

LIST OF PARTS

Symbol to Order By	The figures in the last column refer only to the plates illustrating the parts and are not to be used in ordering. Refer to insert for prices.	Plate No.
39289 J	Sewing Line Welt Guide Stop, for Styles 39200 AS, 39200 AT, 39200 AV (screw No. 22747, nut No. 35178 G) - - - - -	16
39289 N	Sewing Line Welt Guide Slide, for Style 39200 AV (screw No. 22594) - - - - -	26
39289 Q	Operating Lever, for retractable hemming guide on Style 39200 AV (screw No. 86)	20
39289 R	Sewing Line Welt Guide Slide Swinging Support, for Styles 39200 AS, 39200 AT, 39200 AV (pivot screw No. 22707, lock nut No. 907, spring washer No. 23144 B)	26
39289 S-1	Overhanging Guide, for 1 inch welt on Style 39200 AU (screw No. 187 A) - - - - -	27
39289 S-1 1/4	Overhanging Guide, for 1 1/4 inch welt (screw No. 187 A) - - - - -	27
39289 T	Overhanging Guide Support Base, for Style 39200 AU (screw No. 22849) - - - - -	27
39289 U	Overhanging Guide Hinge, for Style 39200 AU (screw No. 22799 B) - - - - -	20
39289 V	Overhanging Guide Hinge Spring, for Style 39200 AU (screw No. 187 B) - - - - -	21
39289 AS	Sewing Line Welt Guide, for Styles 39200 AS, 39200 AT, 39200 AV (screw No. 94) - - - - -	20
39297 E	Presser Foot Tongue, marked "CJ", for Styles 39200 E, 39200 AE - - - - -	9
39297 F	Presser Foot Tongue, marked "CK", for Styles 39200 F, 39200 L - - - - -	9
39297 J	Presser Foot Tongue, marked "CL", for Style 39200 J - - - - -	9
39297 K	Presser Foot Tongue, marked "BY", for Style 39200 K - - - - -	9
39297 Q	Presser Foot Tongue, marked "BW", for Style 39200 Q - - - - -	9
39297 AC	Presser Foot Tongue, marked "CM", for Styles 39100 C-1/8, 39200 B, 39200 C, 39200 AC-1/8, 39200 AD-1/8, 39200 AR - -	9
39297 AD	Presser Foot Tongue, marked "CP", for Styles 39100 C-3/32, 39200 AC-3/32, 39200 AD-3/32 - - - - -	9
39297 AH	Presser Foot Tongue, marked "CC", for Styles 39200 AA, 39200 AH, 39200 AJ - - -	9
39297 AN	Presser Foot Tongue, marked "CD", for Style 39200 AN - - - - -	9
39297 AS	Presser Foot Tongue, marked "CN", for Styles 39200 AS, 39200 AT, 39200 AV - - -	9
39297 AU	Presser Foot Tongue, marked "CR", for Style 39200 AU - - - - -	9
39298	Presser Foot Tongue Screw No. 604	
39298	Knife Grinder, complete - - - - -	29

LIST OF PARTS

Symbol to Order By	The figures in the last column refer only to the plates illustrating the parts and are not to be used in ordering. Refer to insert for prices.	Plate No.
39303	Gauge, for Style 39300 A (washer No. 8372 A) - -	27
39303 B	" for Style 39300 B (washer No. 8372 A) - -	27
39305 A	Feed Dog, for Styles 39300 A, 39300 B (screw No. 93) - - - - -	4
39320 A	Presser Foot Assembly, hinged bottom, for Style 39300 A; one each Nos. 39330 C, 91, 22799 F, 39130, 39130 A, 39330 D, 39397 A; two each Nos. 604, 22738 - - - - -	6
39320 B	Presser Foot Assembly, hinged bottom, for Style 39300 B; one each Nos. 39330 B, 91, 604, 22738, 22799 F, 39130, 39130 A, 39397 B - - -	6
39324 A	Throat Plate, for Styles 39300 A, 39300 B (screw No. 22561) - - - - -	2
39330 B	Presser Foot Bottom, for Style 39300 B (hinge screw No. 22799 F) - - - - -	8
39330 C	Presser Foot Bottom, for Styles 39200 J, 39300 A (hinge screw No. 22799 F) - - - - -	9
39330 D	Presser Foot Extension, right, for Style 39300 A (screw No. 604) - - - - -	10
39374	Feed Rocker, for Styles 39300 A, 39300 B - - - -	22
39397 A	Presser Foot Tongue, marked "BN", for Style 39300 A (screw No. 604) - - - - -	9
39397 B	Presser Foot Tongue, marked "BQ", for Style 39300 B (screw No. 604) - - - - -	9
41064 B	Feed Rocker Shaft (set screw No. 531) - - - -	25
41071 G	Cloth Plate Spring Screw Nut, for Style 39100 V	14
41255 B	Stitch Regulating Ball Joint Fork, for right access (screw No. 22747) - - - - -	18
43137	Stitch Regulating Stud Nut, for Styles 39200 J, 39300 A, 39300 B - - - - -	14
*43141	Feed Rocker Connecting Rod Ball Joint, for Styles 39200 J, 39300 A, 39300 B (screw No. 97 A) - - - - -	18
*43221	Pulley, grooved for No. 2 "V" belt, for Style 39200 J (set screw No. 22597 A, spot screw No. 22597, rim screw No. 22559 B) - - - - -	30
43232	Cloth Plate Spring, for Styles 39100 C, 39100 M, 39100 N, 39100 S, 39200 B, 39200 C, 39200 E, 39200 F, 39200 G, 39200 J, 39200 K, 39200 L, 39200 Q, 39200 R, 39200 AA, 39200 AC, 39200 AD, 39200 AE, 39200 AH, 39200 AJ, 39200 AN, 39200 AQ, 39200 AR, 39200 AU, 39200 AW, 39300 A, 39300 B (screw, hexagonal head No. 22707, screw, fillister head No. 22588 A, nut No. 907) - - - - -	21
43232 N	Cloth Plate Pivot Pin, for styles equipped with steel cloth plate (set screw No. 531 when cloth plate journals on pin, set screw No. 22560 A when cloth plate pivot pin journals in bed) - - - - -	19
43232 R	Cloth Plate Pivot Pin Screw Washer - - - - -	13
43237	Stitch Regulating Ball Stud Nut, for left access - - - - -	14

*See Page 9

LIST OF PARTS

Symbol to Order By	The figures in the last column refer only to the plates illustrating the parts and are not to be used in ordering. Refer to insert for prices.	Plate No.
43241 A	Stitch Regulating Ball Joint Stop- - - - -	13
*43241 D	Stitch Regulating Ball Joint, for left access (screw No. 97 A, nut No. 43237) - -	18
*43243 H	Upper Looper Connecting Rod Ball Joint (bearing screw No. 97 A, locking stud No. 39243 G, locking stud nut No. 907, locking stud washer No. 8372 A) - - - - -	18
43254	Needle Bar Link- - - - -	22
43255 B	Lifter Lever, for machines equipped with "V" belt (stop pin No. 42 A) - - - - -	22
43261 D	Sheet Metal Side Cover Hinge Pin, for Styles 39200 AS, 39200 AT, 39200 AV - - - - -	26
43281 J	Welt Attachment Bracket, for Styles 39200 AS, 39200 AT, 39200 AV (attaching screw No. 22848) - - - - -	30
43294 A	Oil Drain Support (screw No. 22596)- - - - -	38
43294 C	" " Pipe, 1 1/4 inches long- - - - -	31
43294 D	" " " 3 inches long- - - - -	31
43294 F	Oil Drain, for nonsubmerged isolated "Electro Drive" "V" belt installation- - -	35
43464 A	Needle Bar Cross Head Thread Guide, for Styles 39100 N, 39200 K, 39200 L, 39200 Q, 39200 AN (screw No. 605) - - - - -	15
K50132	Lower Knife Holder, for Style 39200 AU (screw No. 22862)- - - - -	22
K50415	Lower Looper Tension Post Thread Eyelet, vertical, for Style 39200 AU (porcelain insert No. 668-18, insert ferrule No. 668-19)- - - - -	16
51280 K	Throat Plate Support Dowel Pin, 9/32 inch long - - - - -	19
51292	Tension Post - - - - -	16
51292 A	" " Ferrule - - - - -	16
51292 C	" " Regulating Nut - - - - -	14
51292 D	Tension Thread Eyelet, for needle thread (porcelain insert No. 668-7, insert locking ferrule No. 668-12)- - - - -	16
51292 F-1	Tension Spring, .016 inch diameter wire- - -	21
51292 F-2	" " .022 inch diameter wire- - -	21
51292 F-4	" " .026 inch diameter wire- - -	21
51292 F-5	" " .031 inch diameter wire- - -	21
51292 F-8	" " .037 inch diameter wire- - -	21
51294 A	Oil Drain Clamp Spring - - - - -	38
51295	Isolated Insulator, for "II" installation- -	20
52834 N	Differential Feed Regulating Stud Nut, for Styles 39200 AA, 39200 AC, 39200 AD, 39200 AE, 39200 AH, 39200 AJ, 39200 AS, 39200 AT, 39200 AU, 39200 AV, 39200 AW - -	14

*See Page 9

LIST OF PARTS

Symbol to Order By	The figures in the last column refer only to the plates illustrating the parts and are not to be used in ordering. Refer to insert for prices.	Plate No.
K55504	Presser Foot Assembly, hinged bottom, for Style 39200 AW; one each Nos. K57185, 73 A, 91, 22799 F, 39230 C, K55793- - - - -	6
K55505	Throat Plate, for Style 39200 AW (screw No. 22561)- - - - -	1
K55506	Main Feed Dog, for Style 39200 AW (screw No.94)	5
K55507	Differential Feed Dog, for Style 39200 AW (screw No. 94)- - - - -	5
K55508	Sewing Line Welt Guide Base, for Style 39200 AW (screw No. 28)- - - - -	27
K55510	Oil Reservoir Cover and Lead-in Thread Eyelet, for Style 39200 AW (porcelain insert No. 668-1, insert ferrule No. 668-14, screw No. 22849)- - - - -	28
K55511	Cloth Plate, for Style 39200 AW (side screw No. 22829)- - - - -	40
*K55512	Tension Post Bracket and Spring Actuated Ten- sion Release, complete, for Style 39200 AW (spring No. 3336, lever stud No. 22758) - - -	26
K55513	Cloth Plate Locking Stud (nut No. 11638 M)- - -	26
K55514	" " " " Nut- - - - -	14
*K55515	Front Cover, for Style 39200 AW (screw No. 22711)- - - - -	32
K55516	Cloth Plate Socket Plate, for Style 39200 AW (screw No. 22526, nut No. 14077)- - - - -	30
K55793	Presser Foot Tongue and Guide, for Style 39200 AW (screw No. 73 A) - - - - -	9
K57107	Lower Looper, for Style 39200 AW (screw No. 77)	10
K57185	Presser Foot Bottom, for Style 39200 AW (hinge screw No. 22799 F)- - - - -	8
K57186	Sewing Line Welt Guide Stop, for Style 39200 AW (set screw No. 22743) - - - - -	19
K57190	Sewing Line Welt Guide Support (adjusting screw No. 22873, stud No. 22773, plain washer No. 28577, spring washer No. 12957 E) - - - - -	27
K57191	Sewing Line Welt Guide, for Style 39200 AW (pivot screw No. 22758, spring washer No. 12957 E)- - - - -	27
K57192	Swing-out Gauge, for sewing line welt guide on Style 39200 AW (screw No. 22726 A)- - - - -	27
K57193	Sewing Line Welt Guide Adjusting Screw Tension Spring, for Style 39200 AW (screw No. 90) - -	21
K57194	Sewing Line Welt Guide Assembly, for Style 39200 AW; one each Nos. 22726 A, 22743, 22758, 22773, 22873, 28577, K55508, K57186, K57190, K57191, K57192, K57193; two each Nos. 90, 12957 E - - - - -	27
79077	Adjusting Screw, for overhanging guide hinge block on Style 39100 S- - - - -	11

*See Page 9

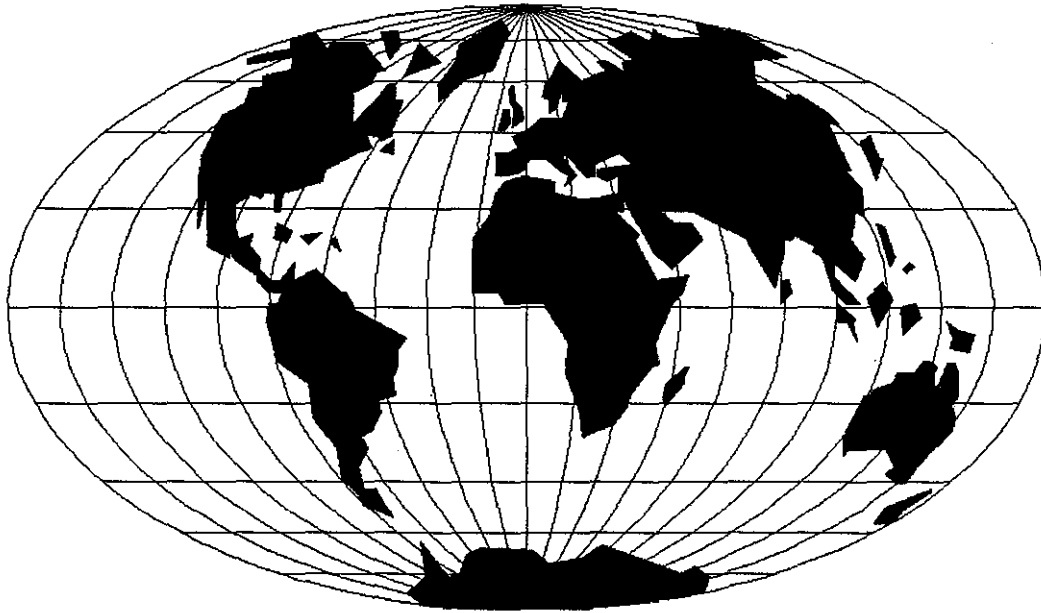

WORLDWIDE SALES AND SERVICE

Union Special Corporation maintains sales and service facilities throughout the world. These offices will aid you in the selection of the right sewing equipment for your particular operation. Union Special Corporation representatives and service technicians are factory trained and are able to serve your needs promptly and efficiently. Whatever your location, there is a qualified representative to serve you.

Corporate Office: One Union Special Plaza
Huntley, IL 60142
Phone: 708•669•5101
Fax: 708•669•1096

European Distribution Center: Union Special GmbH
Raiffelsenstrasse 3
D-71696 Möglingen, Germany
Tel: 49•07141•247•0
Fax: 49•7141•247•100

Brussels, Belgium
Charlotte, N.C.
~~Commerce, CA~~
El Paso, TX
Hong Kong, China
Huntley, IL
Leicester, England
Lille, France
Miami, FL
Milan, Italy
~~Mission, TX~~
Möglingen, Germany
Montreal, Quebec
Osaka, Japan
SANTA FE Springs CA

Other Representatives throughout all parts of the world.



Union Special
INDUSTRIAL SEWING EQUIPMENT

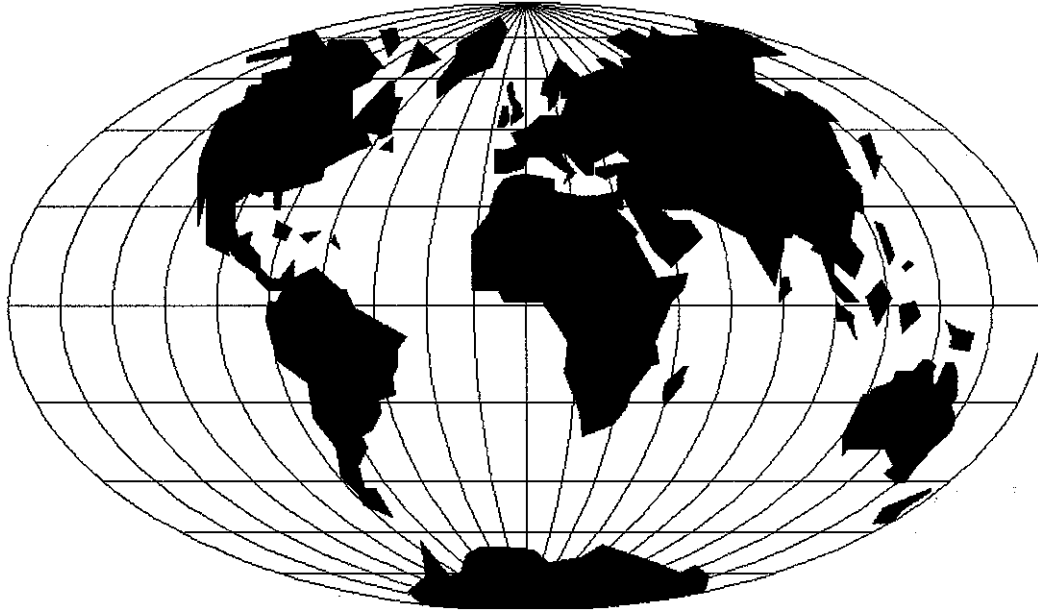

WORLDWIDE SALES AND SERVICE

Union Special Corporation maintains sales and service facilities throughout the world. These offices will aid you in the selection of the right sewing equipment for your particular operation. Union Special Corporation representatives and service technicians are factory trained and are able to serve your needs promptly and efficiently. Whatever your location, there is a qualified representative to serve you.

Corporate Office: One Union Special Plaza
Huntley, IL 60142
Phone: 847•669•5101
Fax: 847•669•1096

European Distribution Center: Union Special GmbH
Raiffeisenstrasse 3
D-71696 Möglingen, Germany
Tel: 49•07141•247•0
Fax: 49•7141•247•100

Brussels, Belgium
Charlotte, N.C.
El Paso, TX
Hong Kong, China
Huntley, IL
Leicester, England
Lille, France
Miami, FL
Milan, Italy
Möglingen, Germany
Montreal, Quebec
Osaka, Japan
Santa Fe Springs, CA

Other Representatives throughout
all parts of the world.



Union Special[®]
INDUSTRIAL SEWING EQUIPMENT