

**SECOND
EDITION**



Union Special
INDUSTRIAL SEWING EQUIPMENT

CATALOG NO. 58 L

STYLES

1900 K	2600 A
1200 A	2600 D
1700 A	5600 C
2300 A	5800 C

LIST OF PARTS AND INSTRUCTIONS



Catalog No. 58 L

LIST OF PARTS

STYLES IN CLASSES

1200	2600
1700	5600
2300	5800

and
Style 1900 K

First Edition

Copyright 1927

By

Union Special Corporation
Rights Reserved in All Countries

UNION SPECIAL CORPORATION

INDUSTRIAL SEWING MACHINES

CHICAGO

July, 1976

Printed in U.S.A.

APPLICATION OF CATALOG

This catalog applies only to the standard styles of machines listed below, but can be applied with discretion to the special machines in Classes 1200, 1700, 1900, 2300, 2600, 5600 and 5800. Information relative to transmitters is contained in Catalog No. 29. Needles are listed and fully described in Catalog No. 45. These catalogs will be furnished gratis on request.

1200 A	2300 P
1200 C	2300 Q
1200 G	2300 R
1200 O	2600 A
1200 Q	2600 D
1200 AA- $\frac{5}{8}$ -inch Finished Width	2600 F
1200 AA- $\frac{3}{4}$ -inch Finished Width	2600 G
1200 AC- $\frac{7}{16}$ -inch Hem	2600 H
1200 AD	2600 J
1700 A	5600 C- $\frac{5}{8}$ -inch Binding
1700 B	5600 C- $\frac{3}{4}$ -inch Binding
1700 F	5800 C- $\frac{1}{2}$ -inch Finished Width
1700 G	5800 C- $\frac{5}{8}$ -inch Finished Width
1700 H	5800 C- $\frac{3}{4}$ -inch Finished Width
1900 K	5800 H- $\frac{1}{2}$ -inch Finished Width
2300 A	5800 H- $\frac{5}{8}$ -inch Finished Width
2300 B	5800 H- $\frac{3}{4}$ -inch Finished Width
2300 M	5800 J- $\frac{1}{2}$ -inch Finished Width
2300 N	

IDENTIFICATION OF MACHINES

A machine equipped with specified parts and fitted for a specific operation is given a **STYLE NUMBER**, the symbol for which is a number evenly divisible by 100, with one or more letters suffixed. Example: 1200 A. Style numbers are classified as **STANDARD** and **SPECIAL**. Style numbers of standard machines do not include the letter "Z," while those including the letter "Z" are special. (See description of Style 1200 Z.) When only minor changes are made a "Z" is merely suffixed to the respective standard style number. Example: 1200 AZ.

Styles of machines similar in construction are grouped and given a **CLASS NUMBER**, the symbol for which is a number evenly divisible by 100, without a letter or letters suffixed. Example: 1200.

STYLES OF MACHINES IN CLASS 1200

Flat Bed One Needle Machines, 5½-inch Space to Right of Needle,
Bed 10 Inches Long, Double Locked Stitch, for Knitted Goods

- 1200 A For finishing knitted underwear and similar garments; feed surface on all four sides of needle, Type 121 needle.
- 1200 C Equipped with split front presser foot No. 65 A, otherwise same as Style 1200 A.
- 1200 G For finishing knitted undershirts; feed surface at left and rear of needle, Type 121 needle.
- 1200 O For finishing knitted drawers; feed surface at left and rear of needle, Type 121 needle.
- 1200 Q For jersey seaming; Type 121 needle.
- 1200 AA For attaching collarettes to knitted undergarments; strip used in long lengths, differential feed, Type 121 needle.
- 1200 AC For hemming bottoms of step-ins, chemises, union suit flaps and similar garments, Type 101 needle.
- 1200 AD For dividing a hem to permit the subsequent insertion of an elastic band, thus producing the elastic heading on bloomers and similar garments, Type 101 needle.
- 1200 Z A special style similar to the standard styles in Class 1200, having several of the standard parts substituted by corresponding parts or equipped with additional parts.

STYLES OF MACHINES IN CLASS 1700

Flat Bed One Needle Machines, 5½-inch Space to Right of Needle,
Bed 10 Inches Long for Glove Work

- 1700 A For pointing gloves, light weight work; Type 121 needle.
- 1700 B For pointing gloves, medium and heavy weight work; Type 121 needle.
- 1700 F For closing canton flannel gloves; DOUBLE LOCKED STITCH, Type 102 needle.
- 1700 G For closing light weight fabric gloves made from silk, chamoisette and similar fabrics, DOUBLE LOCKED STITCH, Type 101 needle.
- 1700 H For closing cotton jersey gloves; DOUBLE LOCKED STITCH; Type 101 needle.
- 1700 Z A special style similar to the standard styles in Class 1700, having several of the standard parts substituted by corresponding parts or equipped with additional parts.

STYLES OF MACHINES IN CLASS 1900

Flat Bed One Needle Machines, $5\frac{1}{2}$ -inch Space to Right of Needle,
Bed 10 Inches Long

- 1900 K For basting clothing, skirts, ladies' suits, dresses and similar garments; chain stitch, maximum length of stitch $\frac{1}{2}$ inch, gauge attached to cloth plate, Type 140 needle.
- 1900 Z A special style similar to the standard styles in Class 1900, having several of the standard parts substituted by corresponding parts or equipped with additional parts.

STYLES OF MACHINES IN CLASS 2300

Flat Bed One Needle Machines, Bed 10 Inches Long, Double Locked
Stitch, Dewees Trimmer, Type 121 Needle

- 2300 A For seaming knitted underwear; minimum width of seam $\frac{3}{32}$ inch.
- 2300 B For seaming knitted underwear; minimum width of seam $\frac{1}{8}$ inch.
- 2300 M For seaming sweaters and other heavy weight materials; minimum width of seam $\frac{1}{8}$ inch.
- 2300 N For closing toes of stockings; minimum width of seam $\frac{3}{32}$ inch.
- 2300 P For seaming knitted underwear; tandem differential feed, minimum width of seam $\frac{3}{32}$ inch.
- 2300 Q For seaming knitted underwear; tandem differential feed, minimum width of seam $\frac{1}{8}$ inch.
- 2300 R For seaming sweaters and other heavy weight materials; tandem differential feed, minimum width of seam $\frac{1}{8}$ inch.
- 2300 Z A special style similar to the standard styles in Class 2300, having several of the standard parts substituted by corresponding parts or equipped with additional parts.

STYLES OF MACHINES IN CLASS 2600

Flat Bed One Needle Machines, Bed 10 Inches Long, Double Locked
Stitch, for Shoe and Leather Work

- 2600 A For closing shoes; plain seam, upper and under feed, Type 501 needle.
- 2600 D For closing leather shoes; welt seam, using pre-folded welt, upper and under feed, Type 501 needle.
- 2600 F For closing shoes, plain seam, under feed only, flat presser foot, Type 501 needle.
- 2600 G For closing shoes; plain seam, under feed only, rolling presser foot, diameter of roller $1\frac{5}{16}$ inches, Type 501 needle.

STYLES OF MACHINES IN CLASS 2600 (Cont'd)

- 2600 H For French binding operations on oxfords, pumps, slippers, sandals and other irregular shaped articles; under feed only, Type 501 needle.
- 2600 J For "Gimp" or ornamental stitching on pumps, oxfords and similar articles; rolling presser foot, diameter of roller $\frac{13}{16}$ inch, Type 121 needle.
- 2600 Z A special style similar to the standard styles in Class 2600, having several of the standard parts substituted by corresponding parts or equipped with additional parts.

STYLES OF MACHINES IN CLASS 5600

Flat Bed One Needle Machines, Bed 10 Inches Long, Tandem Differential Feed, Double Locked Stitch, Type 121 Needle

- 5600 C For binding necks and fronts of knitted undershirts.
- 5600 Z A special style similar to the standard styles in Class 5600, having several of the standard parts substituted by corresponding parts or equipped with additional parts.

STYLES OF MACHINES IN CLASS 5800

Flat Bed One Needle Machines, Bed 10 Inches Long, Upper and Under Feed, Double Locked Stitch, Type 121 Needle for Miscellaneous Work

- 5800 C For attaching collarettes to knitted undergarments; long length cut edge strip.
- 5800 H For attaching extension button stays to knitted undergarments; long length cut edge strip.
- 5800 J For attaching split tube border to bottoms of step-ins, chemises and similar garments; long length cut edge strip.
- 5800 Z A special style similar to the standard styles in Class 5800, having several of the standard parts substituted by corresponding parts or equipped with additional parts.

NEEDLES

TYPE NUMBER Each needle has a type number and size number.

DESCRIPTIONS The former denotes the kind of point, shank, length, groove, finish and other details. The latter denotes the largest diameter of the blade measured in thousandths of an inch, midway between the shank and eye and is stamped on the needle shank. Collectively, the Type Number and Size Number represent the complete definition of the needle.

The Type Numbers of the needles used in the styles of machines covered by this catalog are listed on the following page. Set opposite each Type Number is the definition of the needles.

NEEDLES (Cont'd)

Type No.	Description
101	Round shank, round point, extra short, double groove, nickel plated.
102	Round shank, round point, extra short, double groove, short blade, nickel plated.
121	Round shank, round point, short, double groove, nickel plated.
140	Round shank, round point, long, double groove, nickel plated.
301	Round shank, stay point, extra short, double groove.
501	Round shank, rocked point, extra short, double groove.
701	Round shank, flat point, extra short, double groove.
1701	Round shank, twist centered point, extra short, double groove.

NOTE: For other types of needles refer to Catalog No. 45.

APPLICATION OF TYPE NUMBERS The styles of machines covered by this catalog are listed herewith. Set opposite each Style Number is the Type Number of the needle generally used.

Machine Style Number	Type No. of Needle Used	Machine Style Number	Type No. of Needle Used
1200 A	121	2300 P	121
1200 C	121	2300 Q	121
1200 G	121	2300 R	121
1200 O	121	2600 A	101, 301, 501, 701, 1701
1200 Q	121	2600 D	101, 301, 501, 701, 1701
1200 AA	121	2600 F	101, 301, 501, 701, 1701
1200 AC	101	2600 G	101, 301, 501, 701, 1701
1200 AD	101	2600 H	101, 301, 501, 701, 1701
1700 A	121	2600 J	101, 121
1700 B	121	5600 C	121
1700 F	102	5800 C	121
1700 G	101	5800 H	121
1700 H	101	5800 J	121
1900 K	140		
2300 A	121		
2300 B	121		
2300 M	121		
2300 N	121		

USE GENUINE NEEDLES Success in the operation of these machines can be secured only by the use of genuine Union Special Needles, as furnished by the Union Special Machine Company, or its subsidiaries. Obviously, it is to our interest to maintain the reputation of the machines by furnishing the very best needles obtainable. They are designed according to the most approved scientific principles and are made with the utmost precision. The maximum efficiency and durability are assured.

Genuine needles are put up in packages marked at the top "Trade 'UNION SPECIAL' mark." All other needles are bogus.

ORDERING To have orders promptly and accurately filled, the empty package, a sample needle, or the Type and Size Numbers should be given. See marks on package. An intelligible order would read as follows:

100 Needles Type 121 Size .040.

ORDERING REPAIR PARTS

PLATES Illustrations of parts similar in appearance and size are shown in groups.

LIST OF PARTS Turning from the plates to the list of parts, the definition of each part and its principal uses will be found. Always check the symbol against its definition before ordering. It is not necessary to furnish the plate number.

When a part is used or can be used in all machines covered by this catalog, no specific use is mentioned in the definition.

For convenience in ordering, minor parts, such as screws, nuts and similar articles are repeated after each major part.

(—) A dash in the "plate number" column of the list of parts indicates the absence of an illustration.

(□) A square in the "Symbol to order by" column indicates that the part is commercial and can be readily purchased in any machinists' supply house.

(‡) A double dagger in the "Symbol to order by" column indicates that the component parts cannot be furnished separately.

IDENTIFYING PARTS Where the construction permits, each part is stamped with its part number. Some of the smaller parts are stamped with an identification letter to distinguish them from parts similar in appearance.

All part numbers represent the same part regardless of the catalog in which they appear.

SUPPLIES All supplies, including taps, reamers, belting, belt hooks, belt fasteners, screw drivers and powdered oil stone will be promptly furnished.

TERMS Prices are strictly net cash and subject to change without notice. Express and freight shipments are forwarded at the buyer's risk F.O.B. shipping point. Parcel post shipments are insured unless otherwise directed. A charge is made to cover the postage and insurance.

Plate 1—Full Size

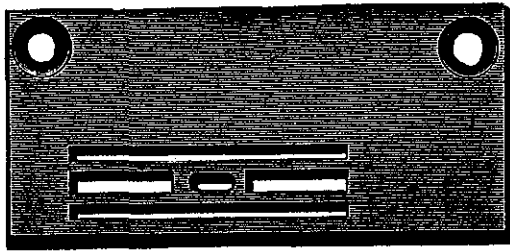

112

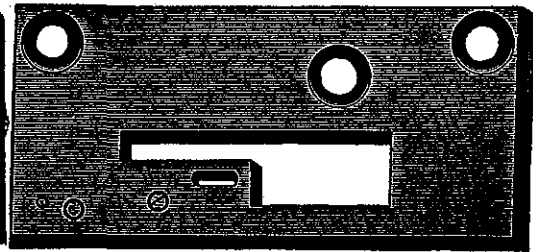

112 CC

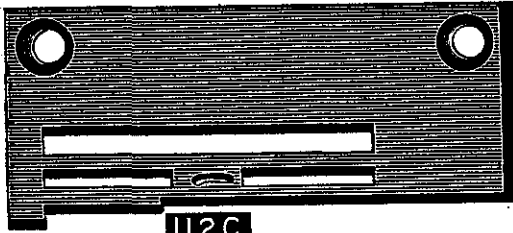

112 C

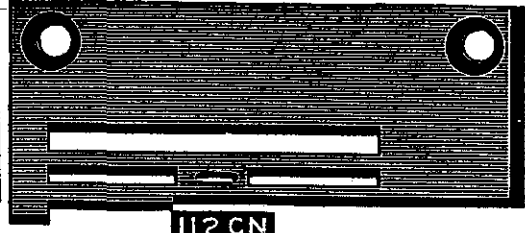

112 CN

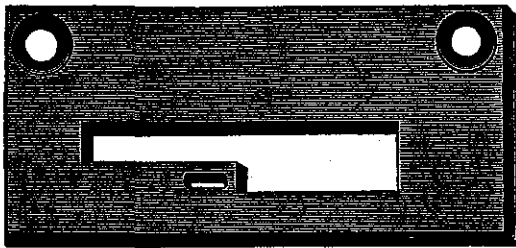

112 E

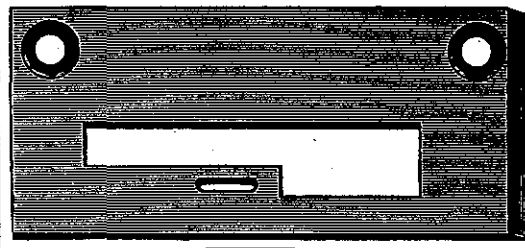

0 112

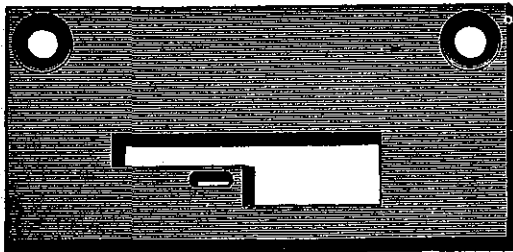

112 S

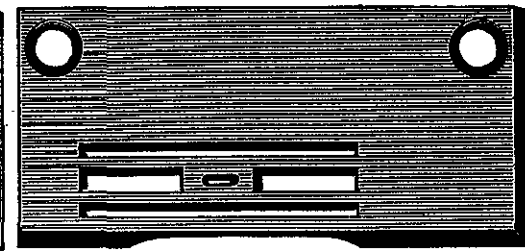

1228 A

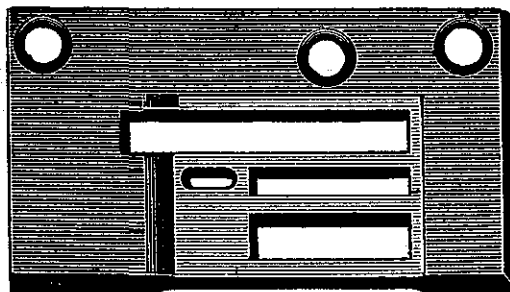

5828 A

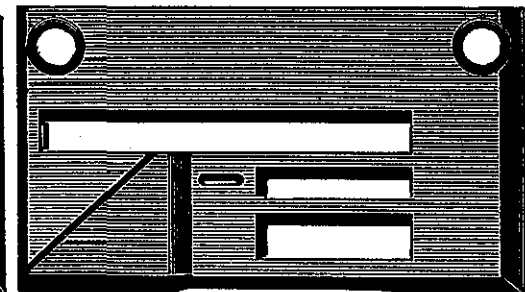

5624 C

Plate 2—Full Size

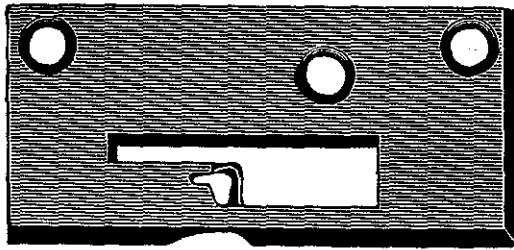

1728 B

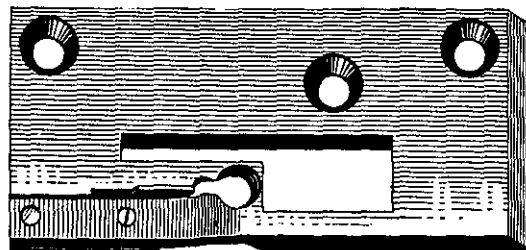

1728 D

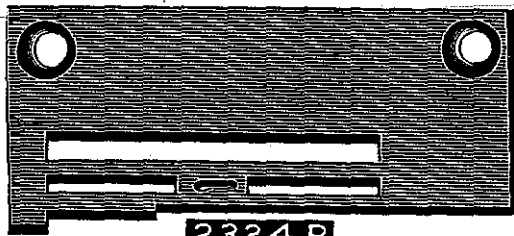

2324 P

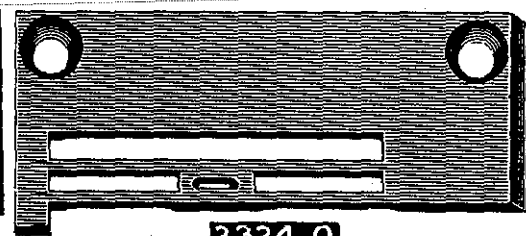

2324 Q

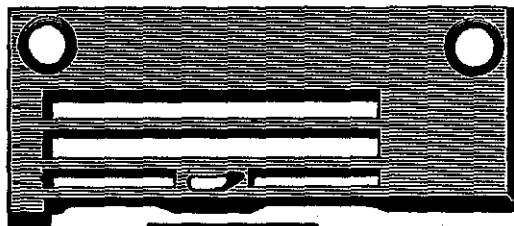

2324 R

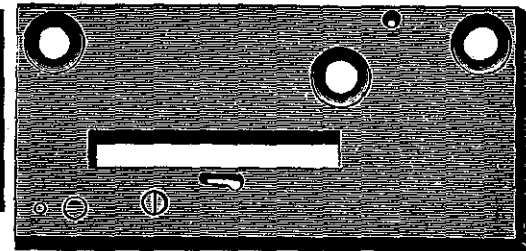

2524 B

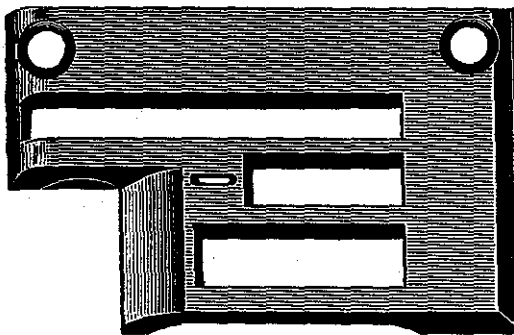

5824 J

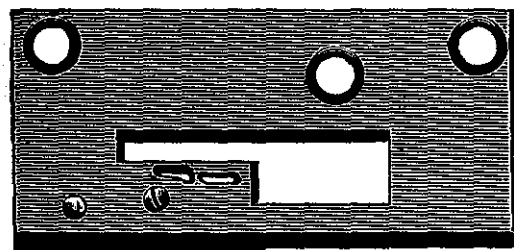

2524 J

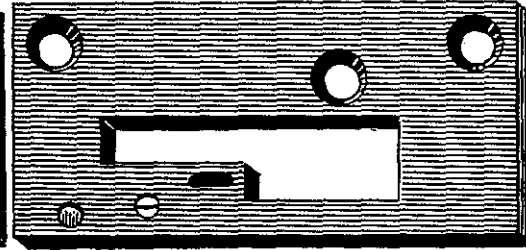

2624 A

Plate 3—Full Size

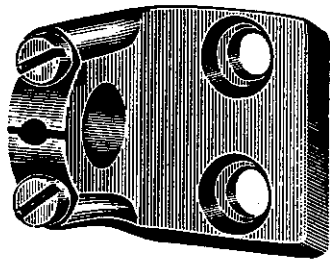

2398

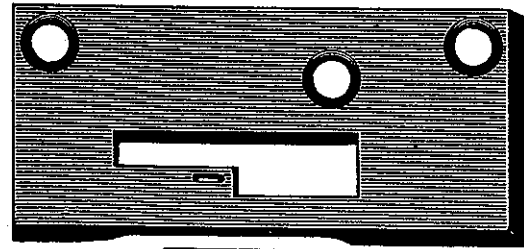

1724 A

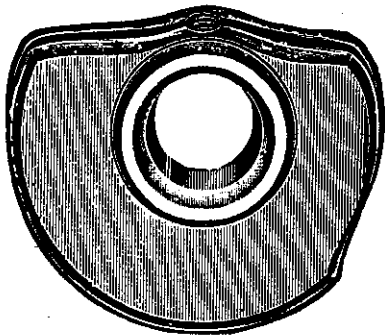

5723

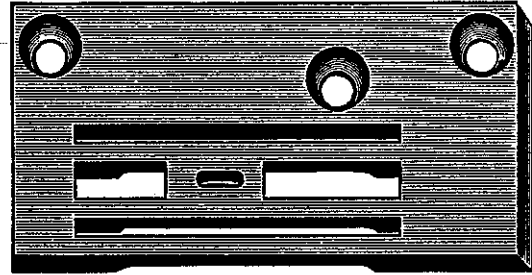

9224 E

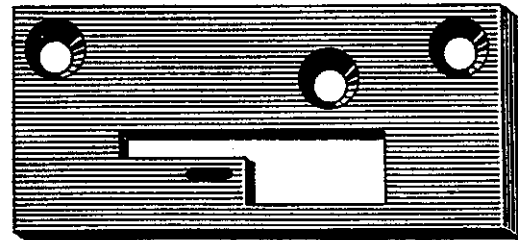

1724 F

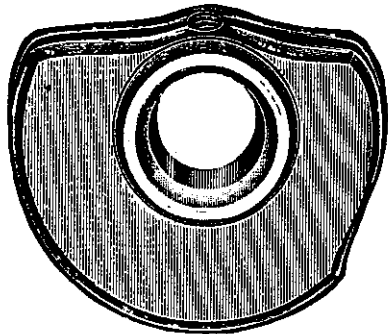

101 V

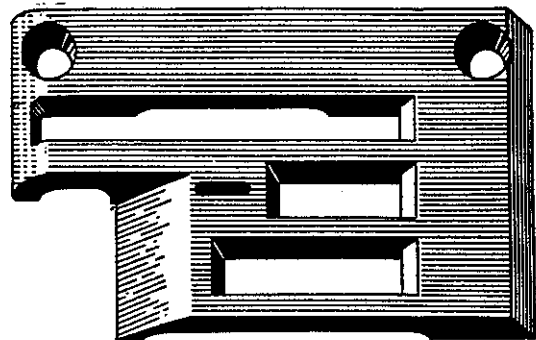

5824 C

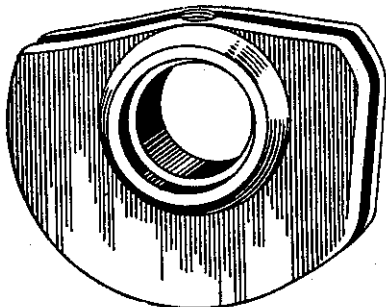

101

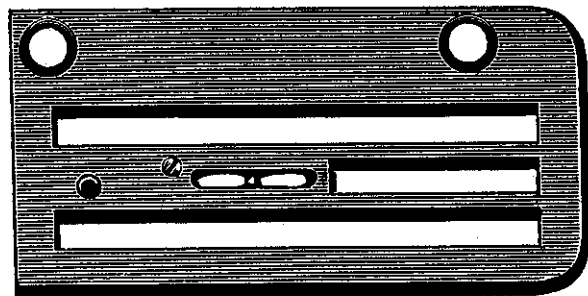

1924 J

Plate 4—Full Size

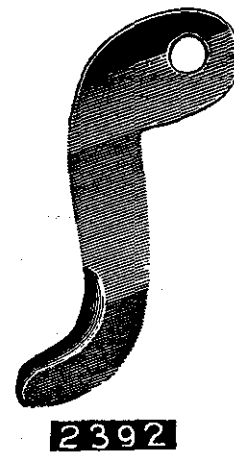
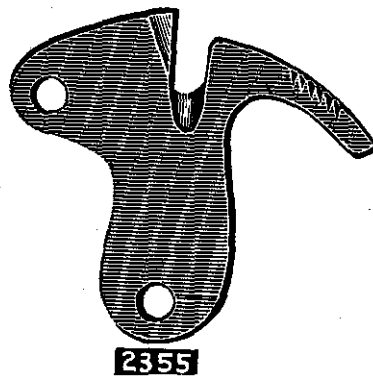
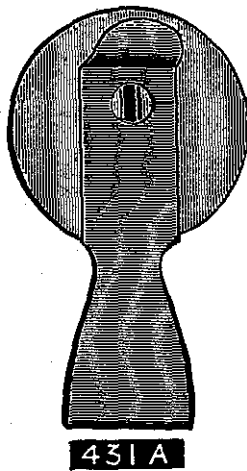
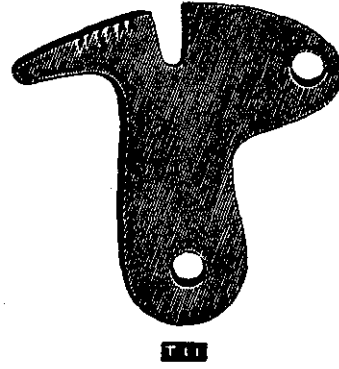
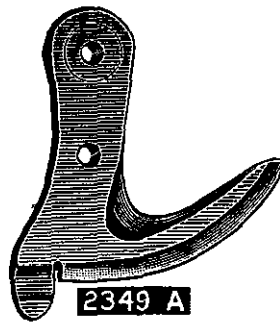
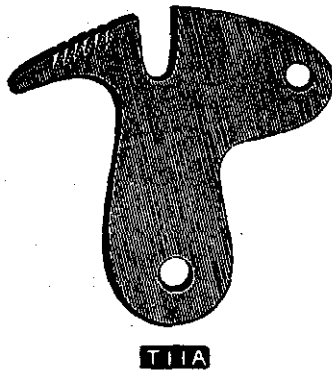
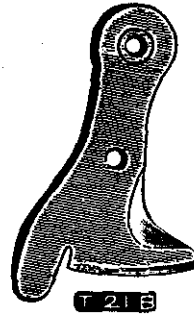
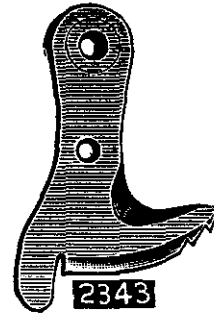
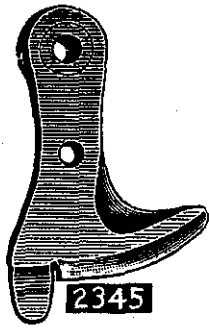

Plate 5—Full Size

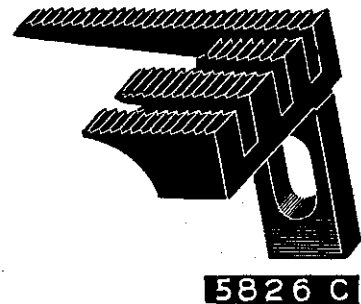
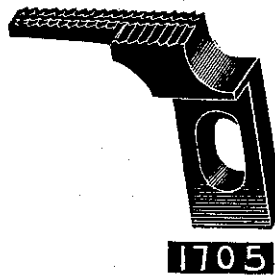
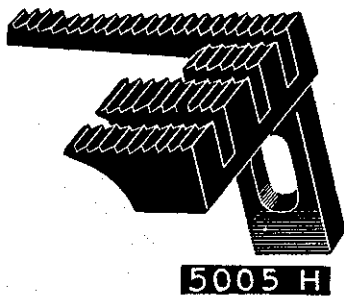
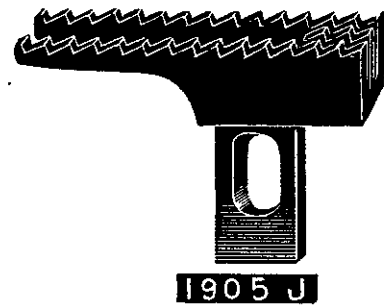
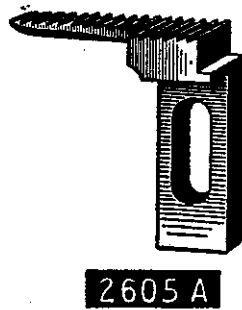
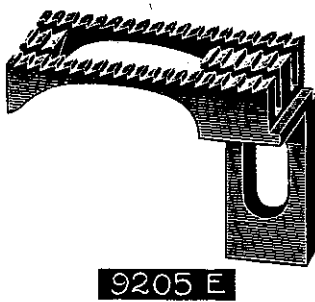
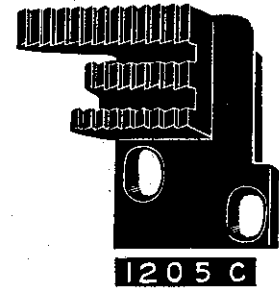
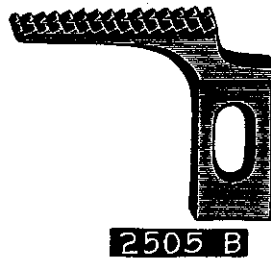
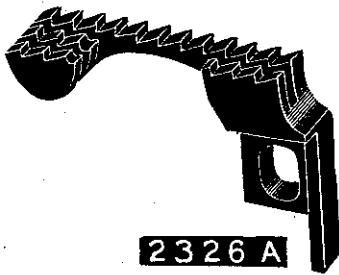
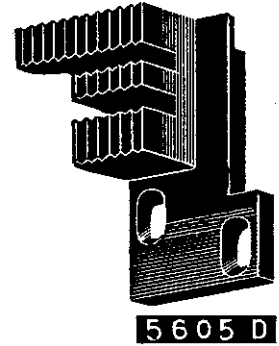
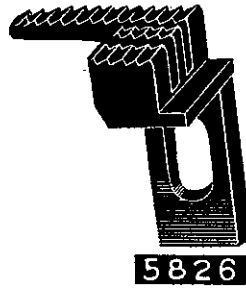
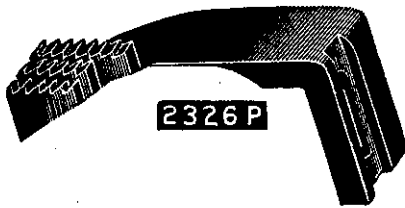
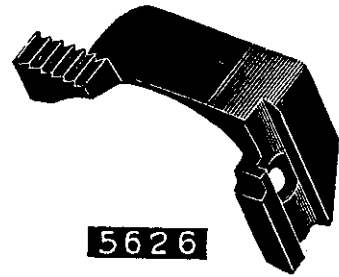
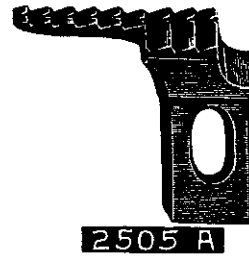
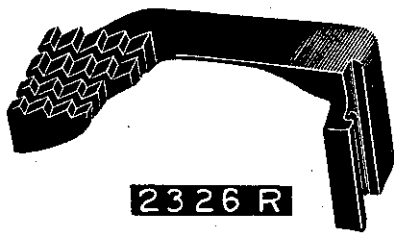

Plate 6—Full Size

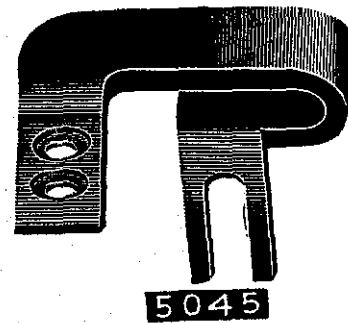
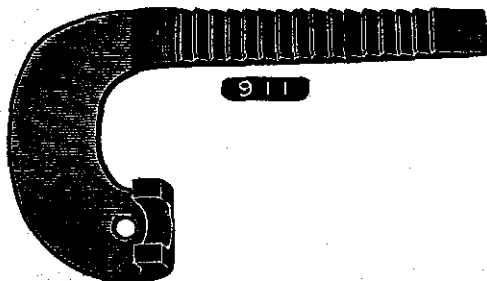
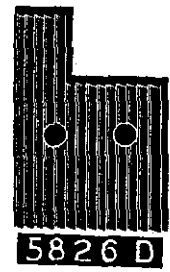
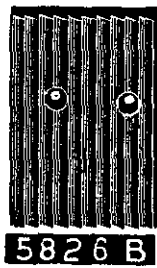
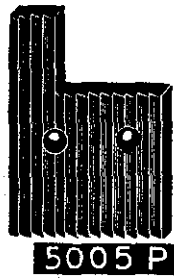
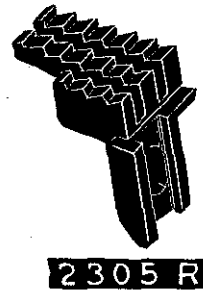
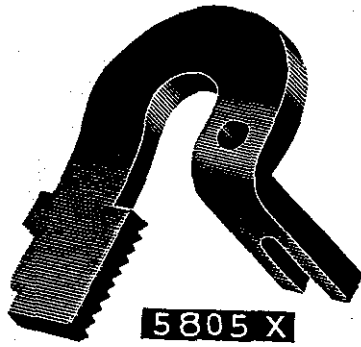
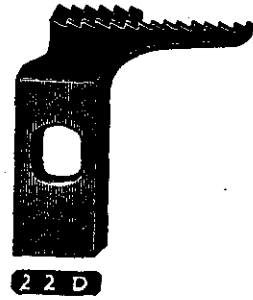
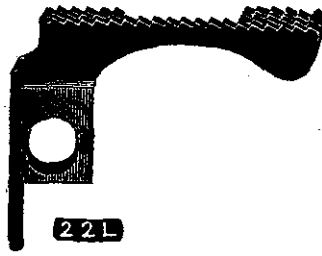
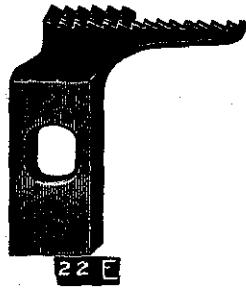
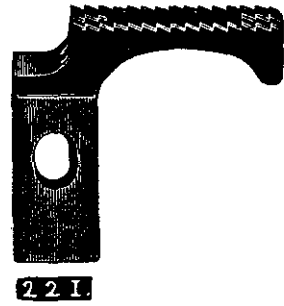
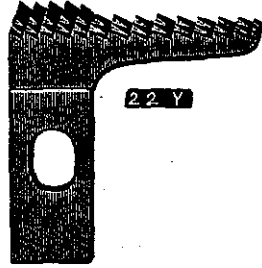
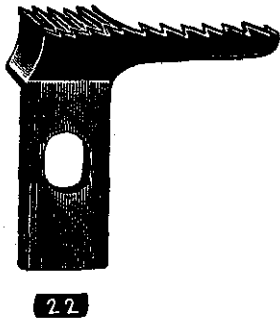

Plate 7—Full Size



65 T



65 A



65 H



65 G

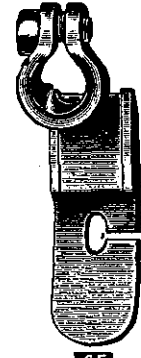

65

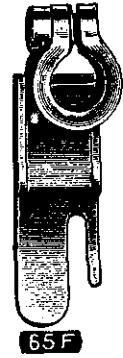

65 F



919



918



1720 B

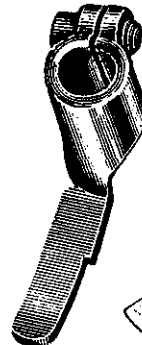

65 L

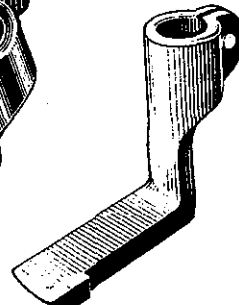

1727 D

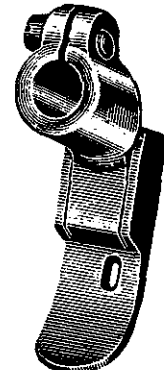

1727 A

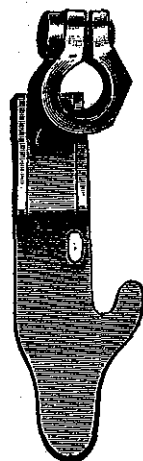

65 C

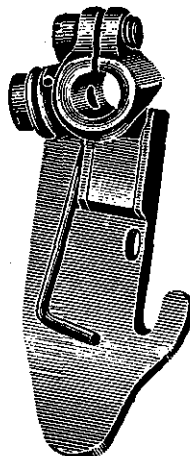

2320 R

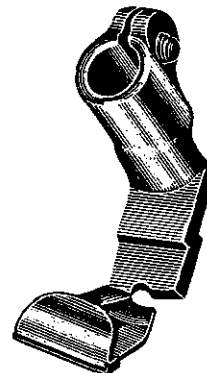

2527 D

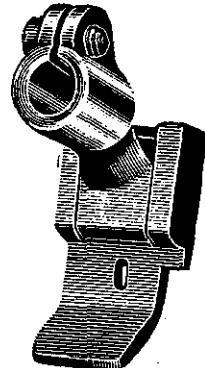

1220 AC

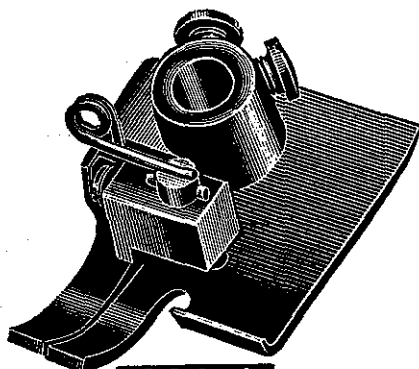

1920 J

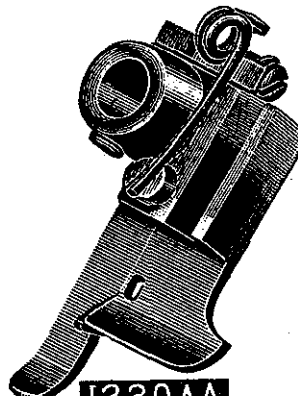

1220 AA

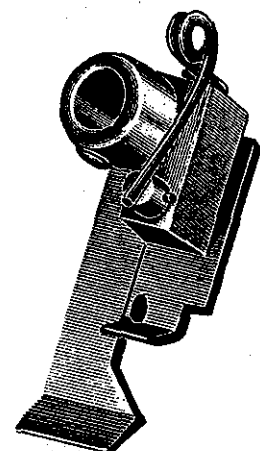

5620 C

Plate 8—Full Size

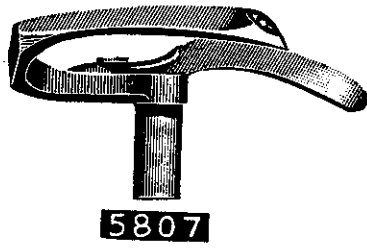

5807

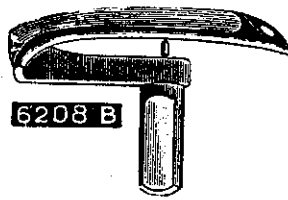

6208 B



A 2G

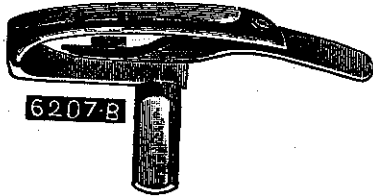

6207 B

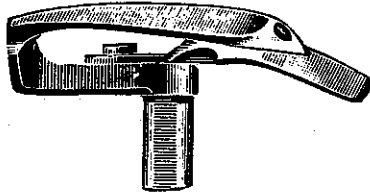

1707 G

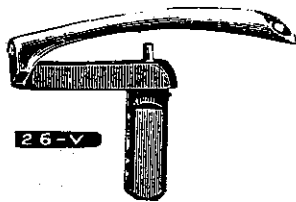

26-V

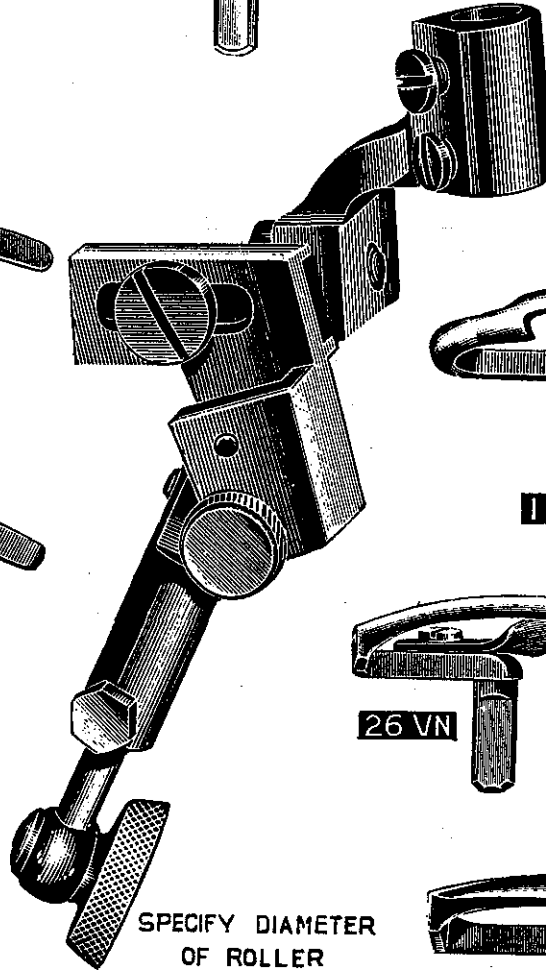

SPECIFY DIAMETER OF ROLLER

1520 M

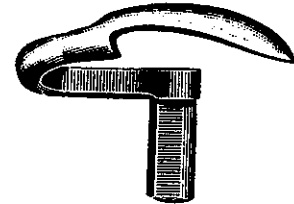

1908 A

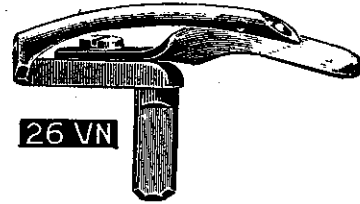

26 VN

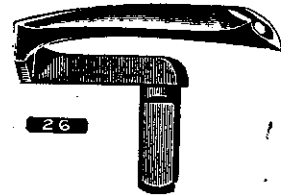

26

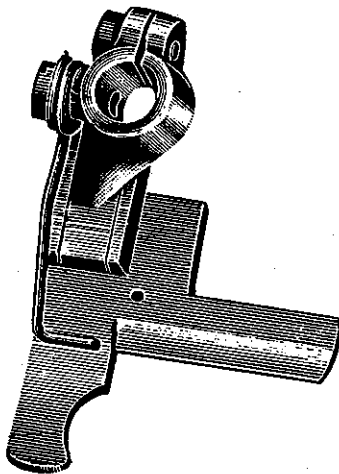

5827 B

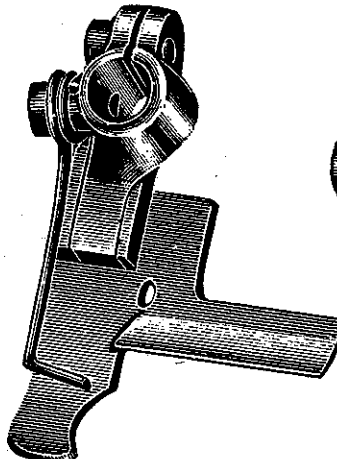

5820 C

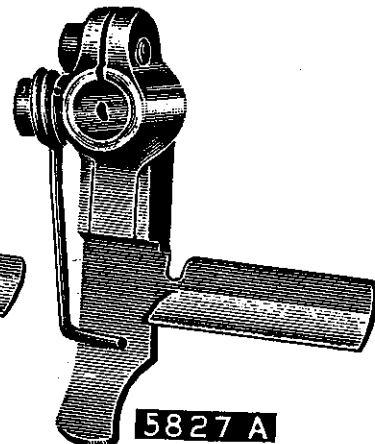

5827 A

Plate 9—Full Size



Plate 10—Full Size



Plate 11—Full Size

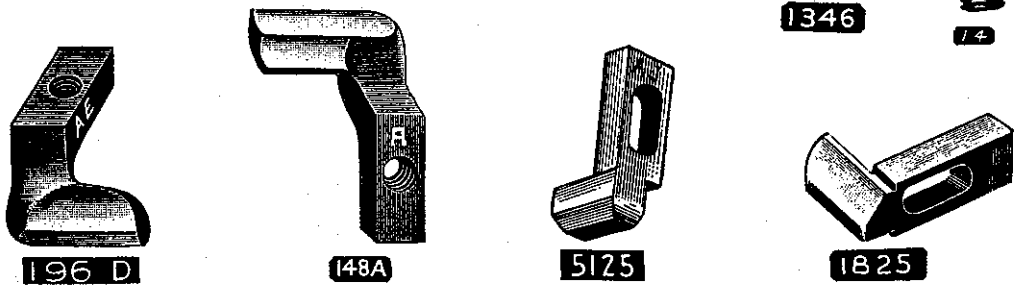
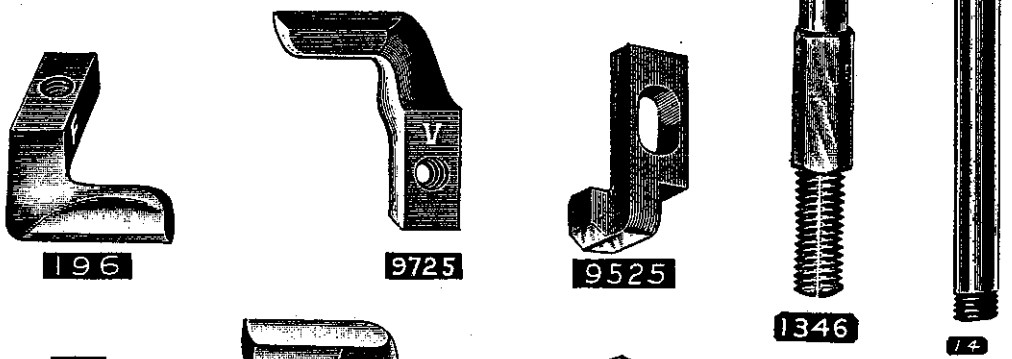
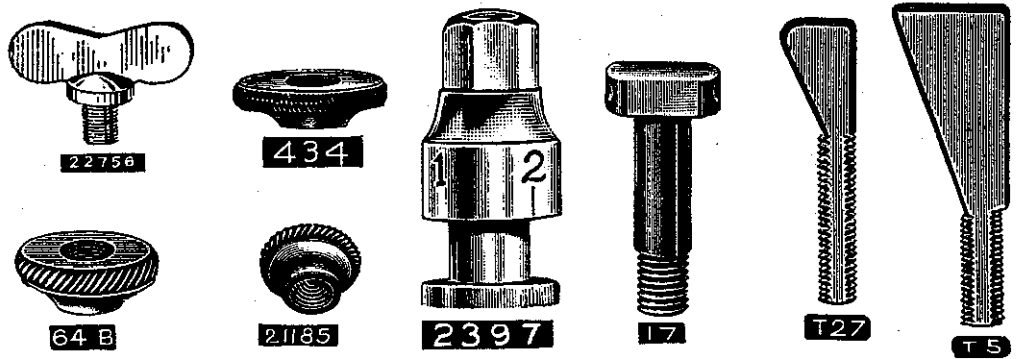
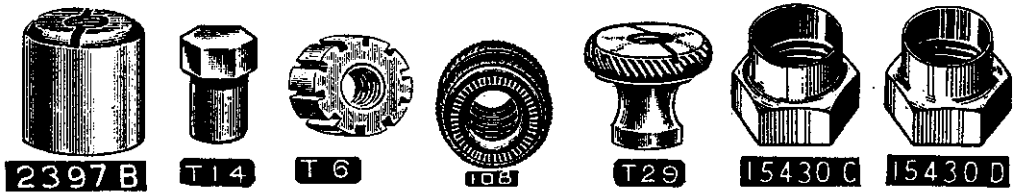
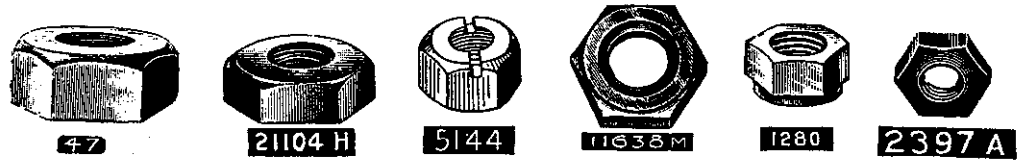
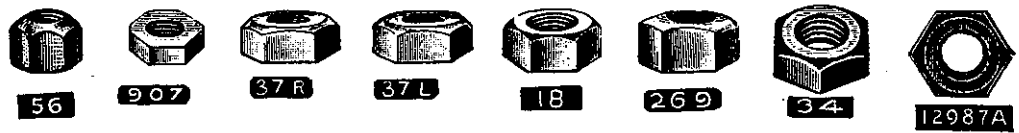

Plate 12—Full Size

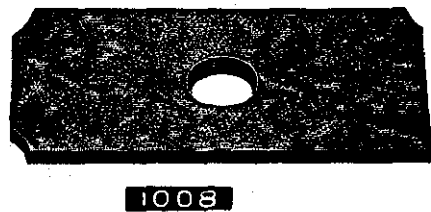
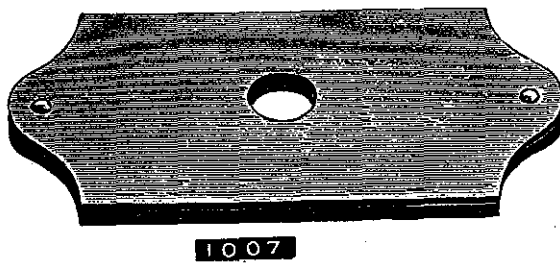
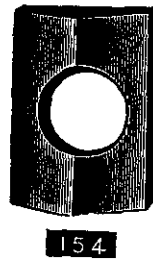
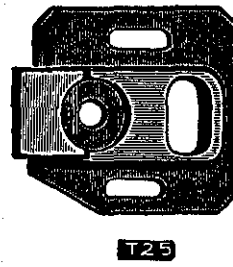
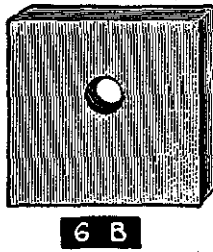
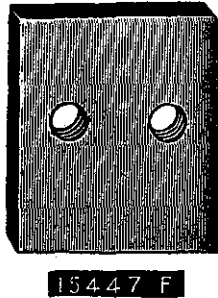
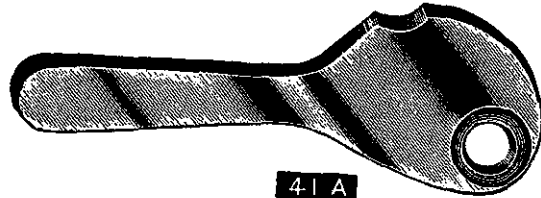
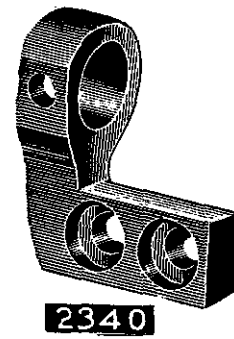
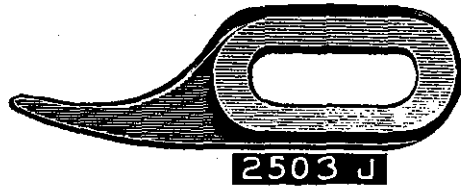
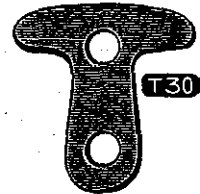
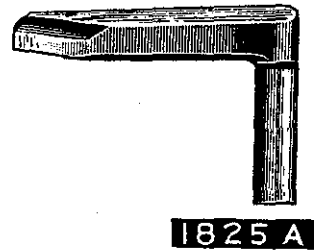
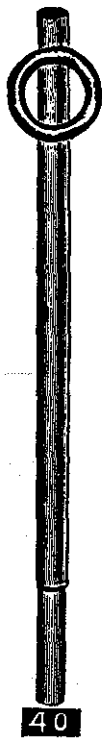
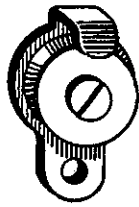

Plate 13—Full Size



21632



21624



52-A



137



53A

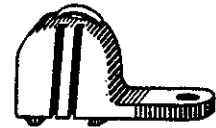

21610 A



57-W B

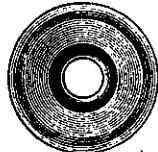

15438 B



1288

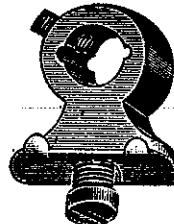

1287

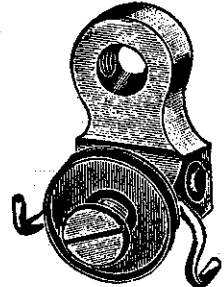

15437 A



27 V



27 X

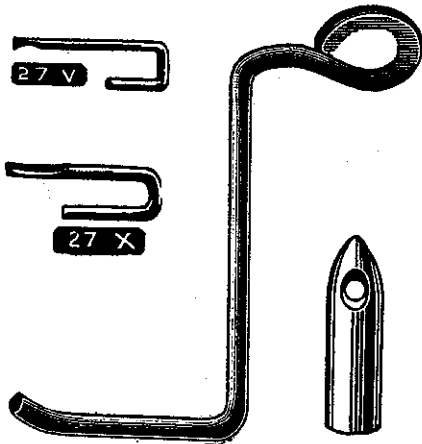

2389 B



334

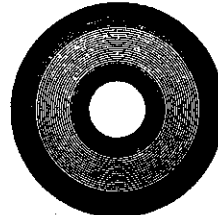

109

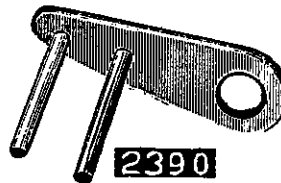

2390



202 A



111

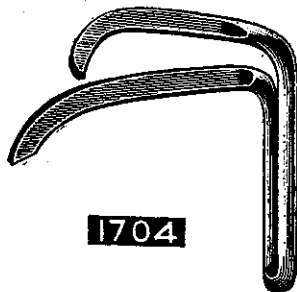

1704

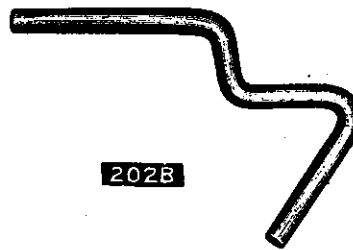

202B

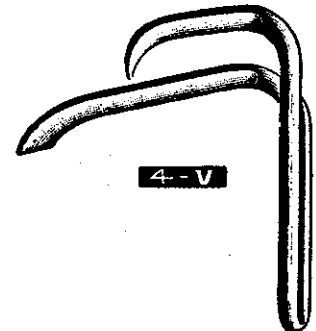

4-V

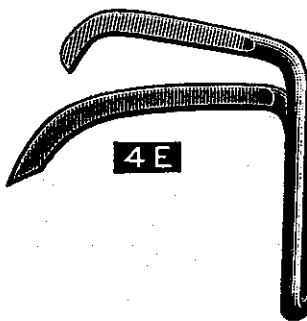

4E

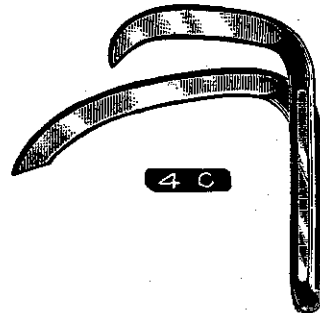

4C

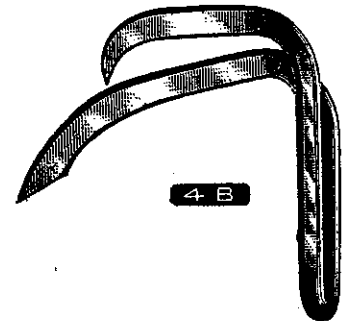

4B

Plate 14—Full Size

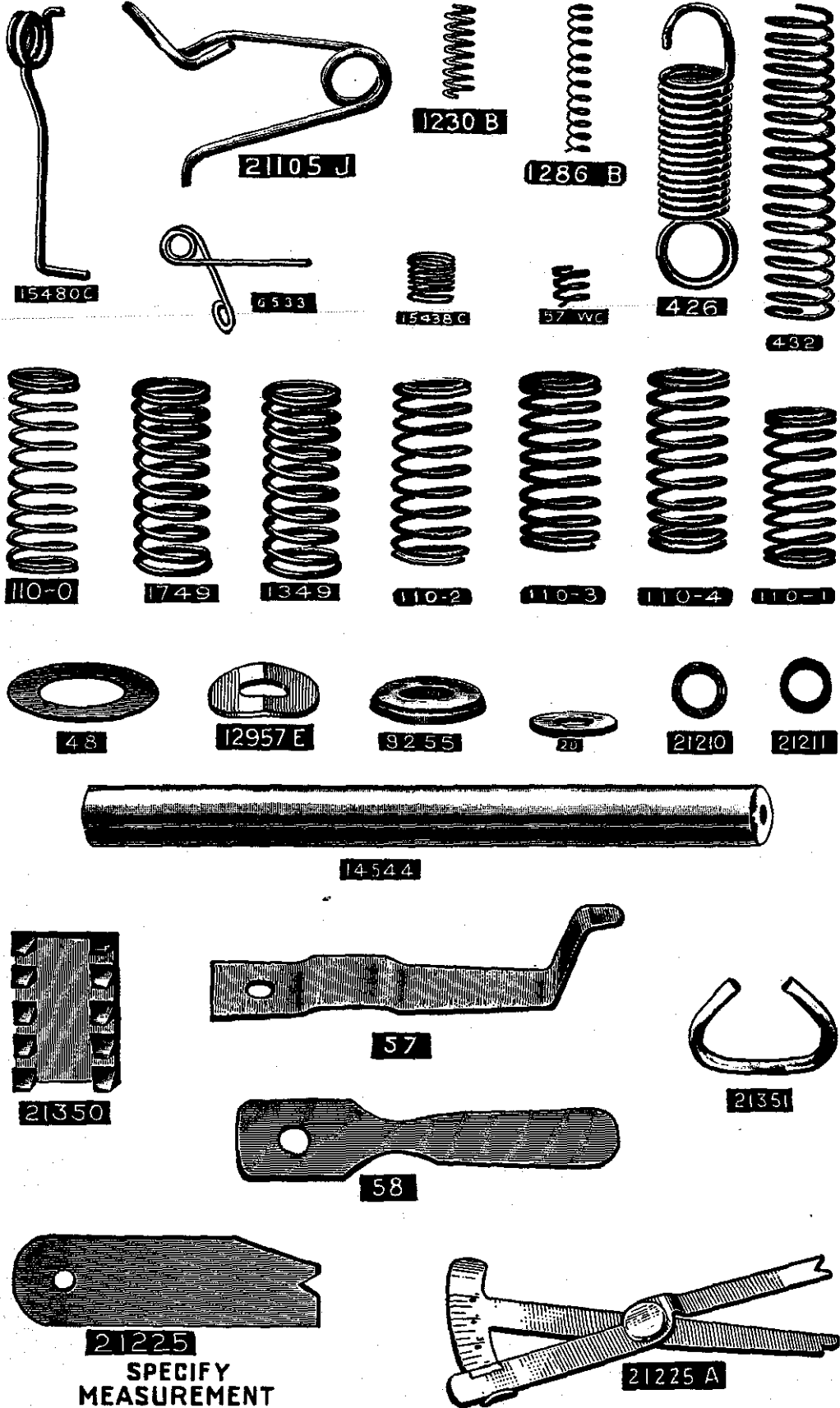
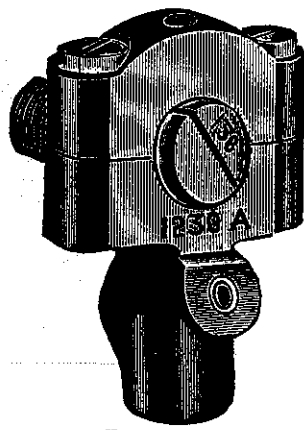
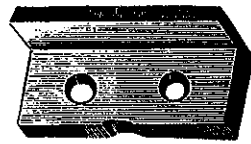

Plate 15—Full Size



29066 B



15447 L

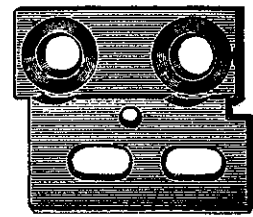

15447 K

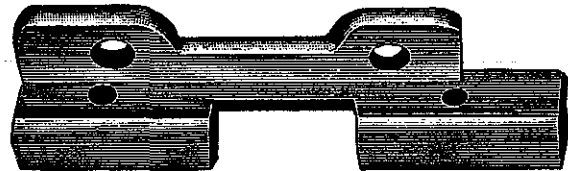

2336

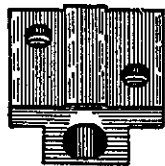

5150

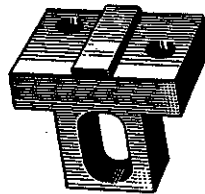

5650

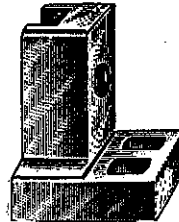

912

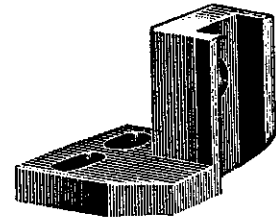

5842 A

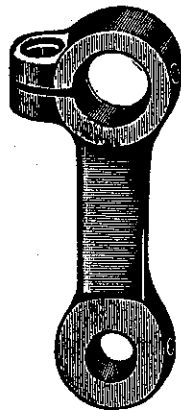

15446 D

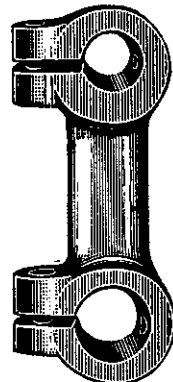

2334



15063



61 G

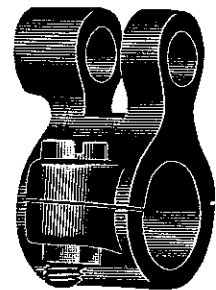

1939



2366 B



2366 E

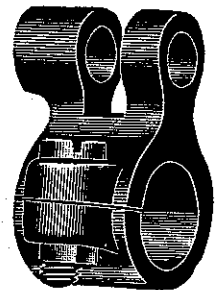

15

Plate 16—Full Size

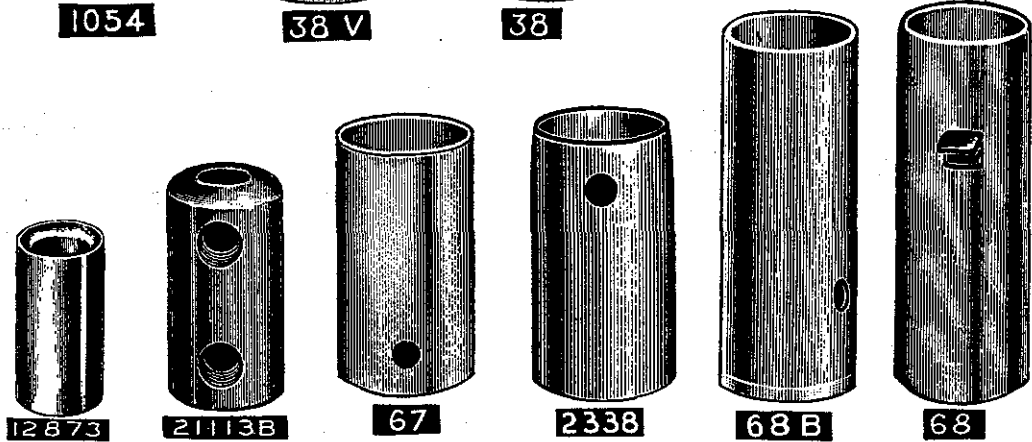
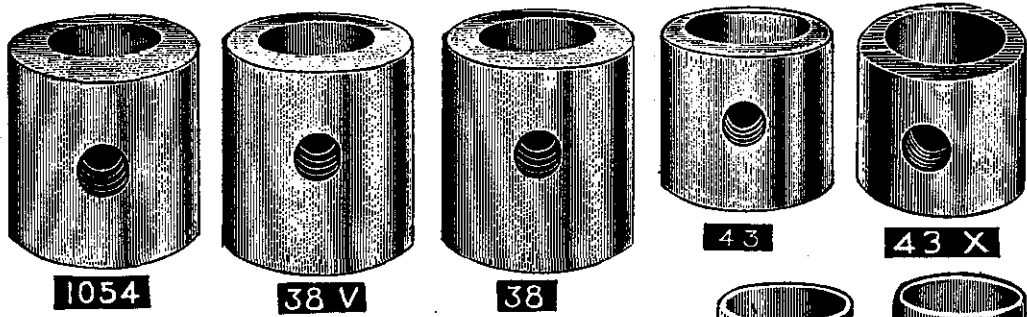
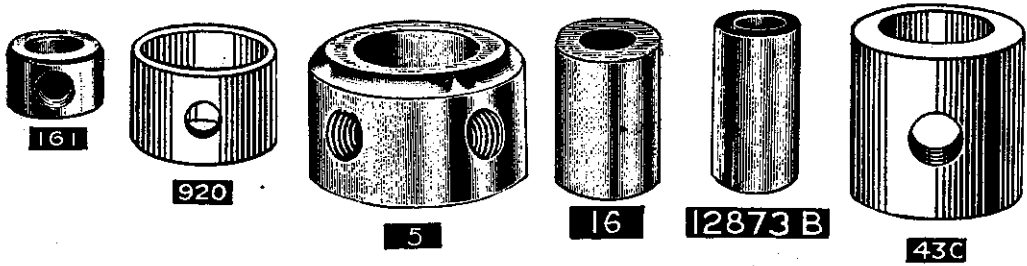
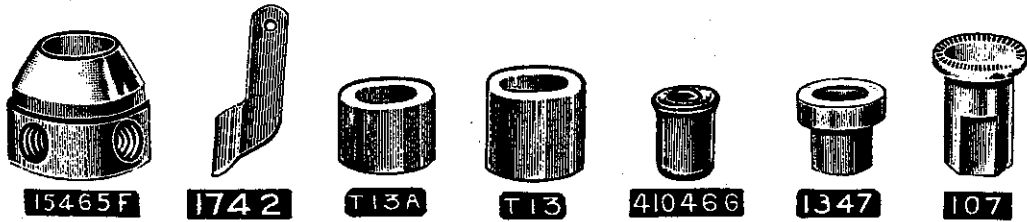
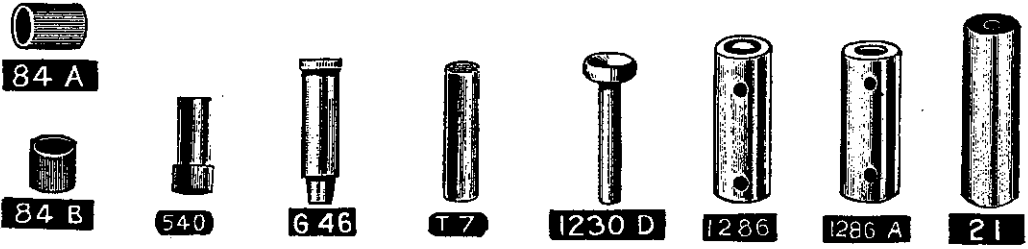

Plate 17—One-half Size

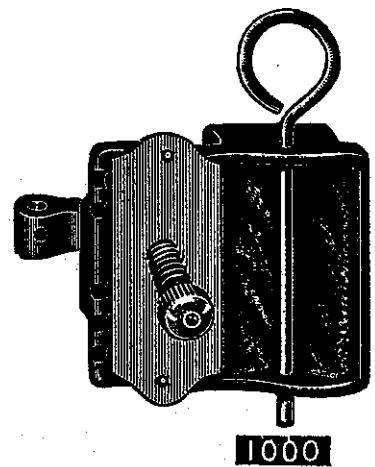
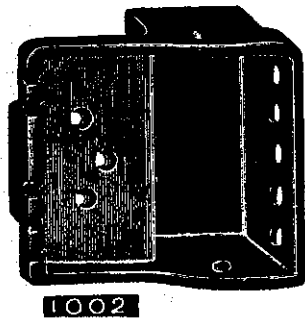
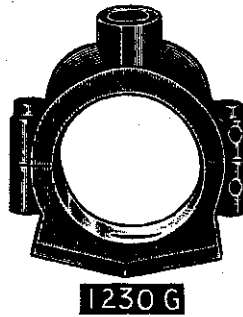
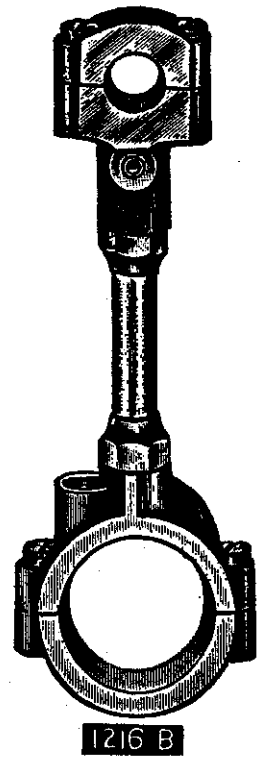
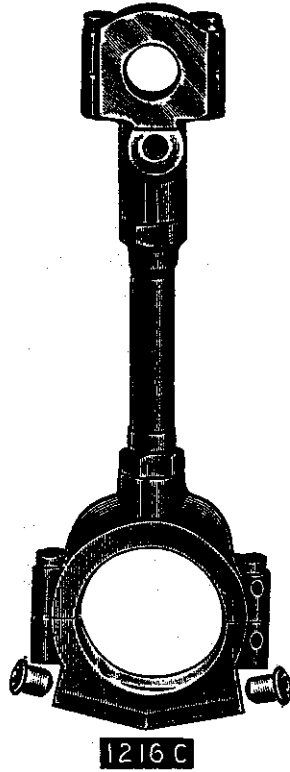
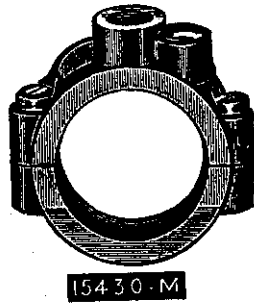
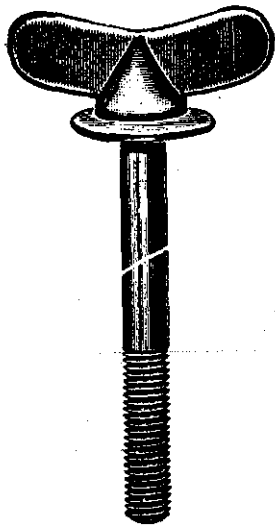
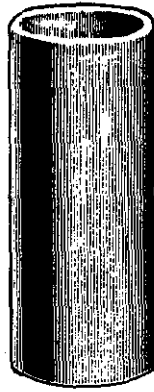

Plate 18—One-half Size



105
SPECIFY
MEASUREMENT



21355B

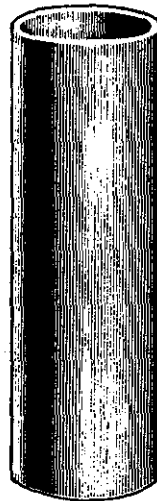

21355



21355 A



1755

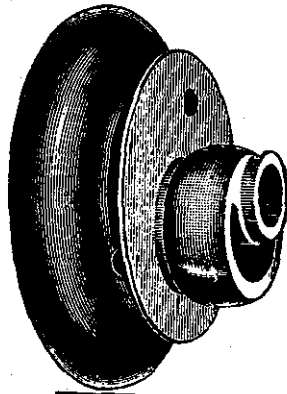

59X

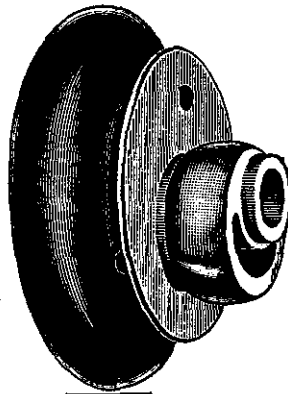

59V

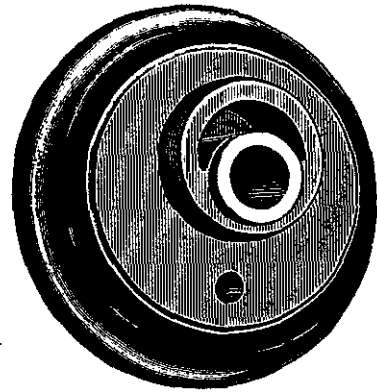

1721

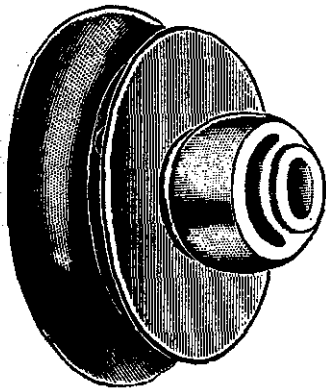

7421

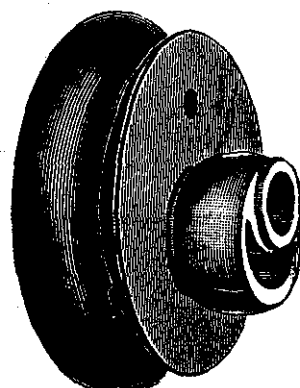

1221

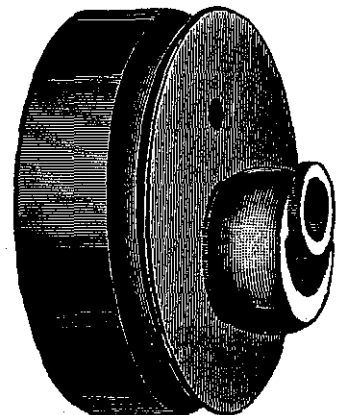

12821

Plate 19—One-half Size

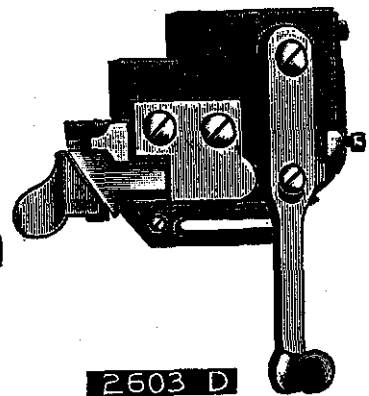
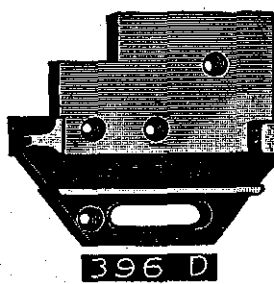
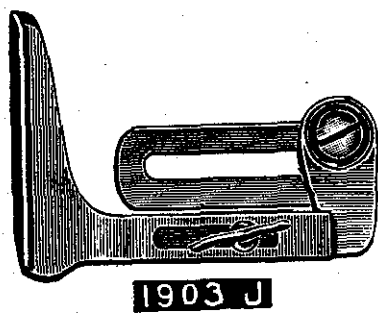
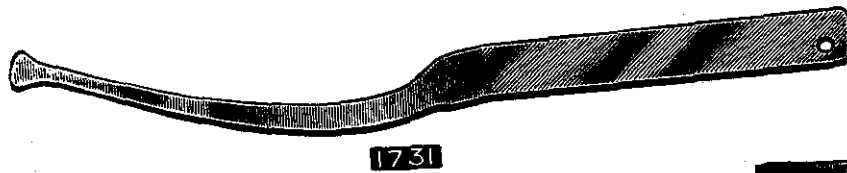
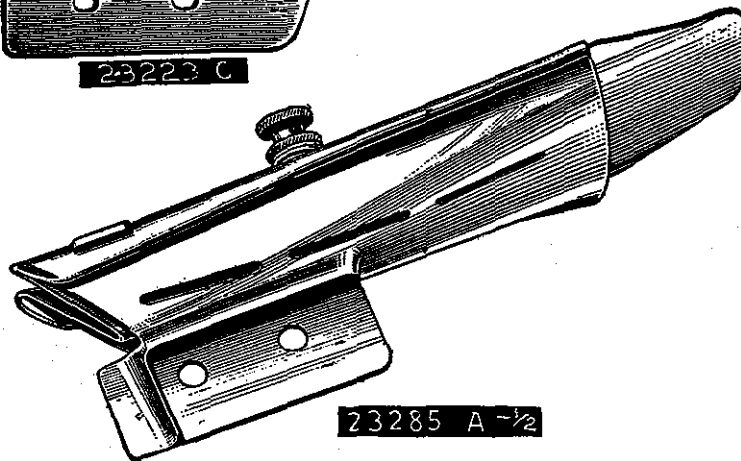
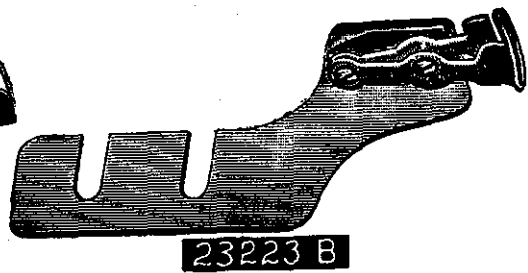
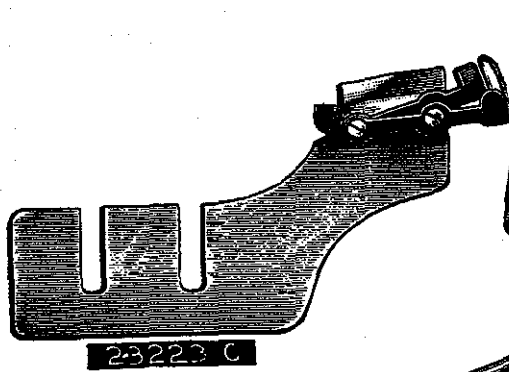
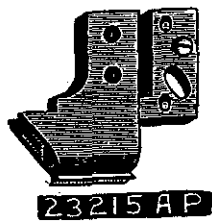

Plate 20—One-half Size



1275 A



2395

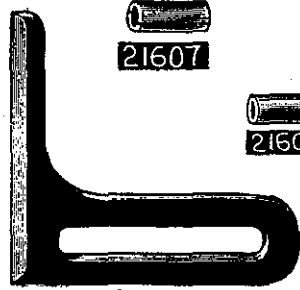

24



21607



21605

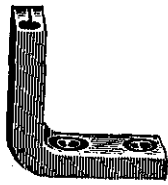

1859



2650



21606



245



118



116



2335

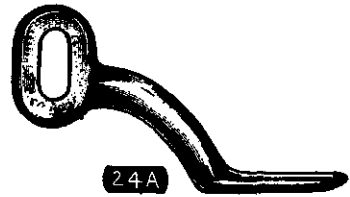

24A

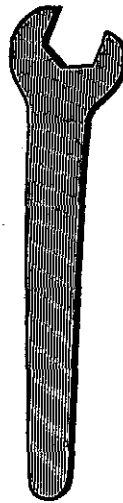

21388 B

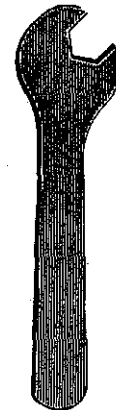

21388



118 B

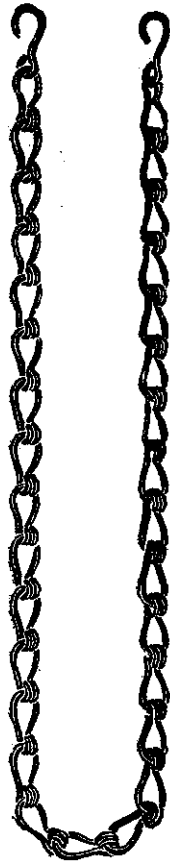

421



419 A



139A

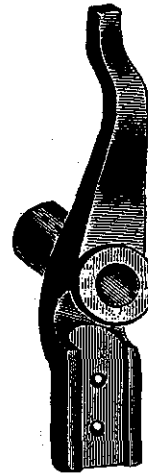

415 B



905

Plate 21—One-half Size

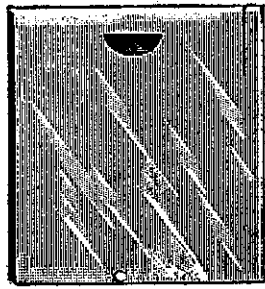

2

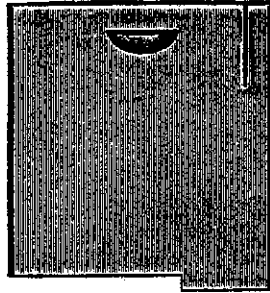

2C

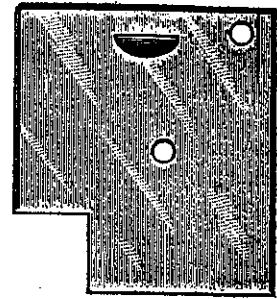

900

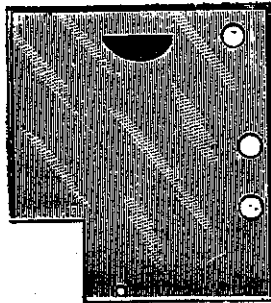

901

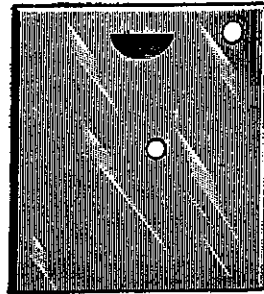

2 S

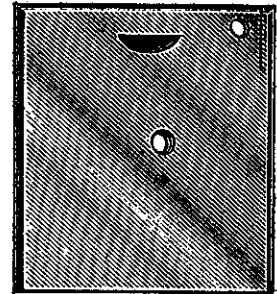

1702

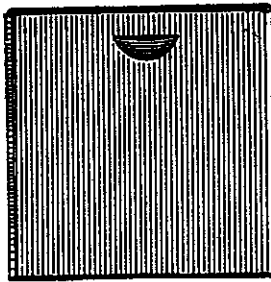

2A

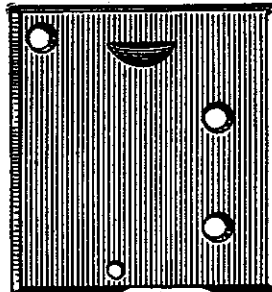

6502 P

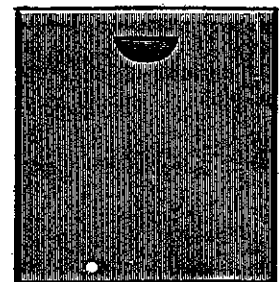

2CU



99

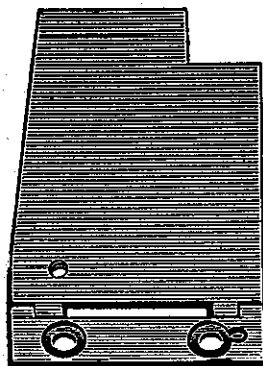

5002 J

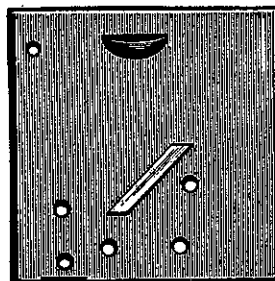

6402 F

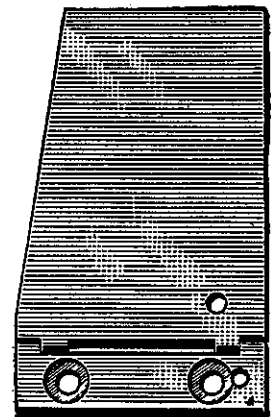

5002 L

Plate 22—One-half Size

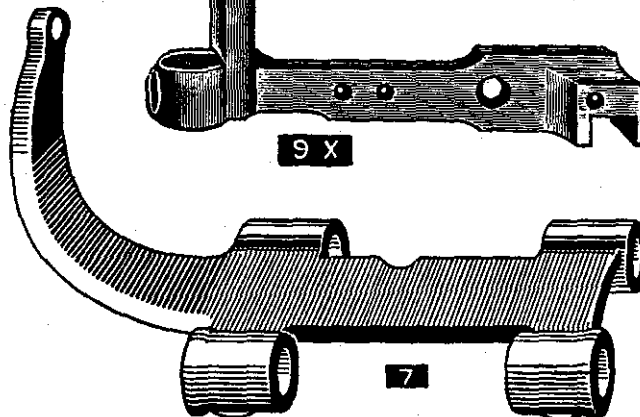
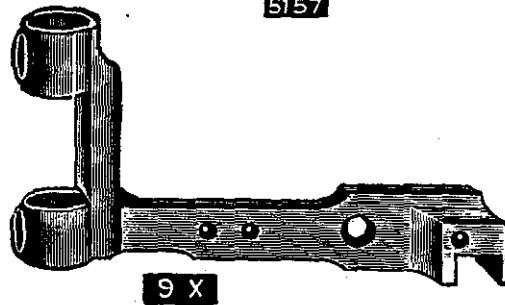
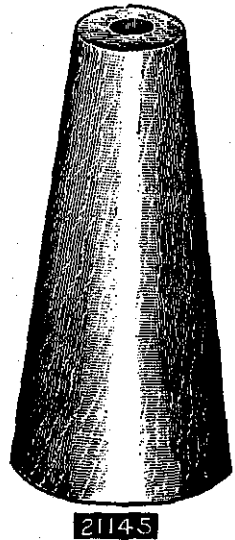
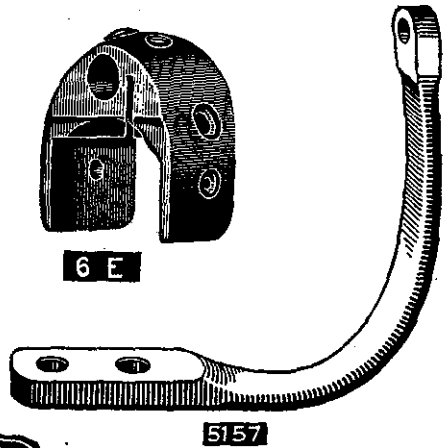
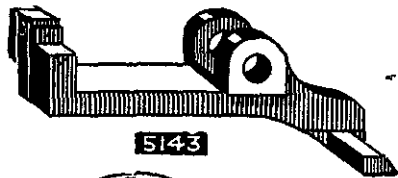
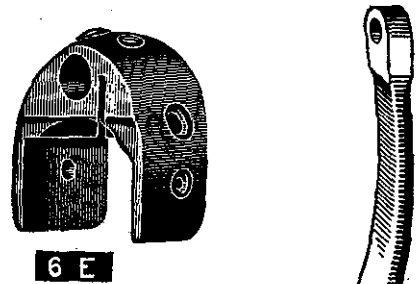
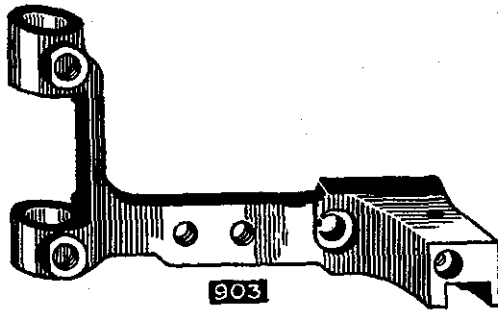
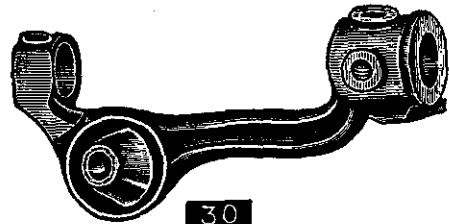
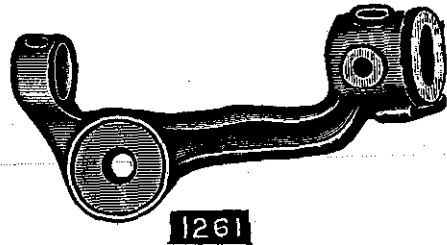
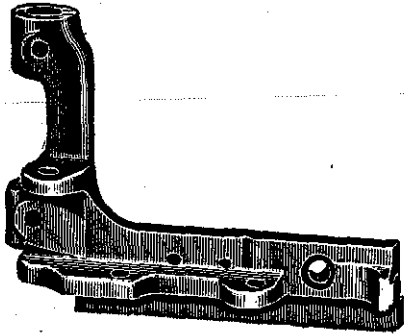
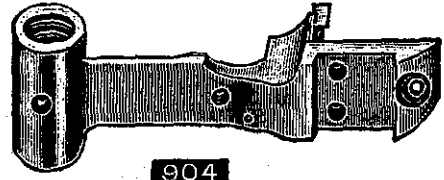
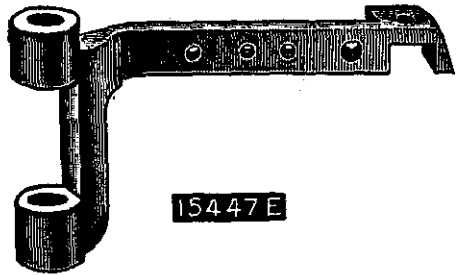

Plate 23—One-half Size

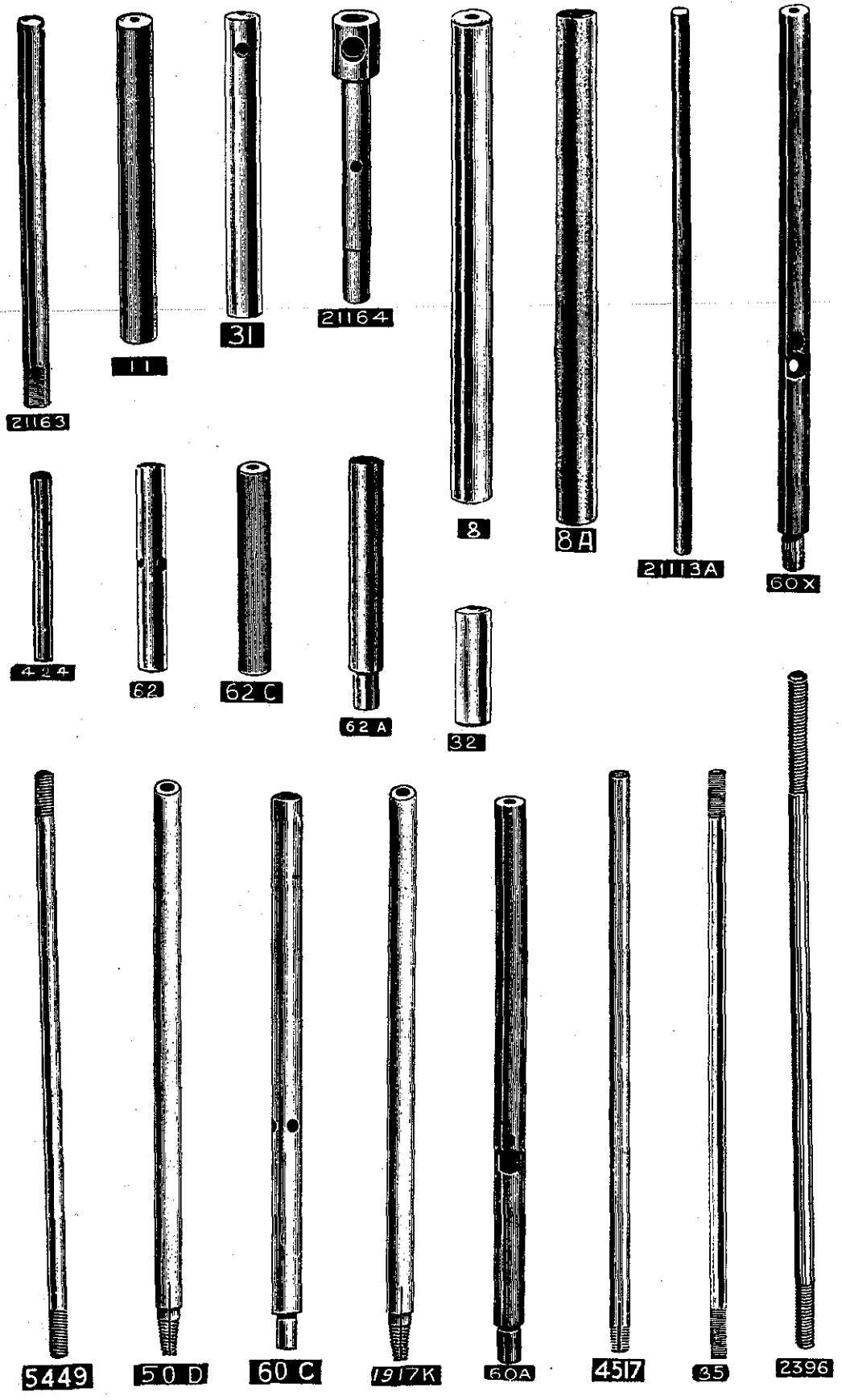
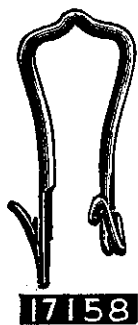

Plate 24—One-half Size



17158



103

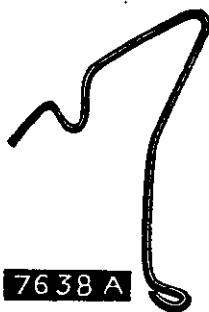

7638 A



21390 B



21390 A

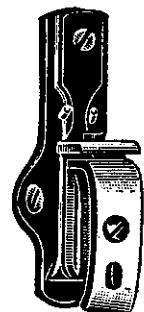

21390 AW



539

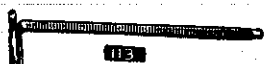

113



113 A



21390 E



64



426 B



13



21608



1940



51



15438 H



15438 J



217



9932



1941

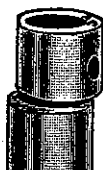

917



30185 A



10314

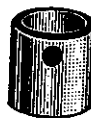

2306



482



14649

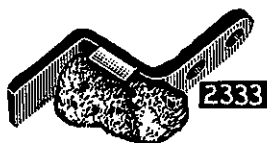

2333

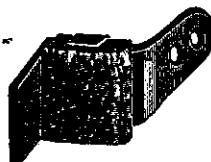

908

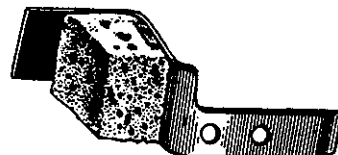

15447 G



10



70



1937

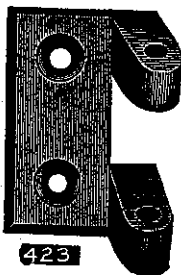

423



21602

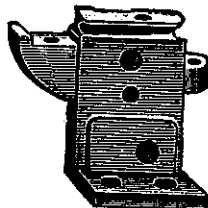

102

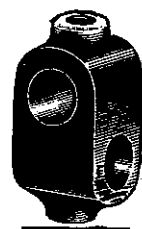

21104 C



21104 E

Plate 25—One-third Size



63 A

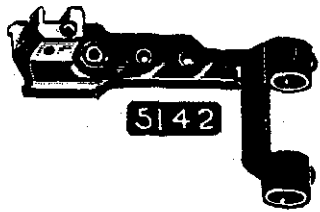

5142



63 B



29



213



29V

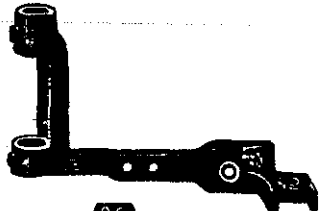

90



66



119



616



21104 B

Specify Length



1922 D

Plate 26—One-fourth Size

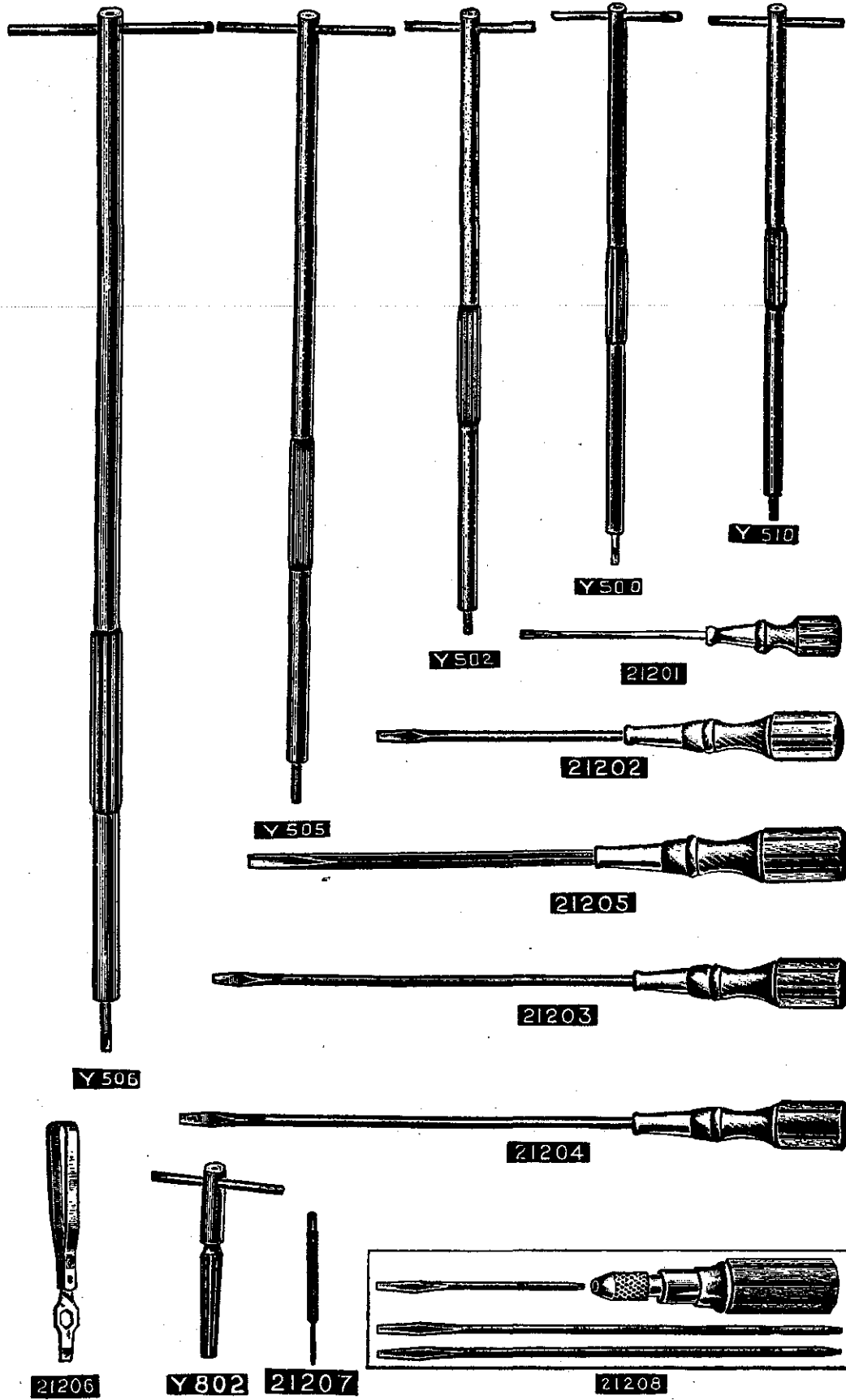

Plate 27—One-fourth Size



23406 6-1/2



23289 1/2

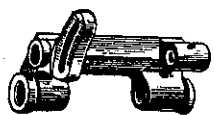

5156



2331

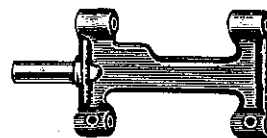

7 G



8646



8647

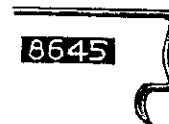

8645

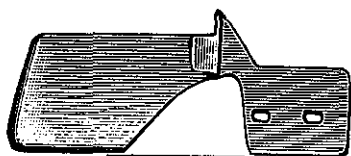

23387-1/16



7 H

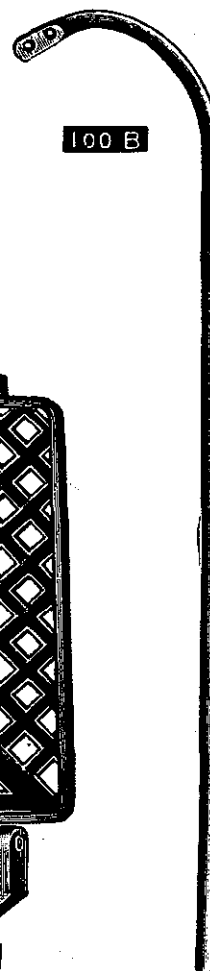

100 B

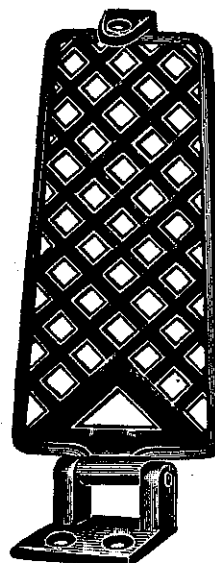

29402

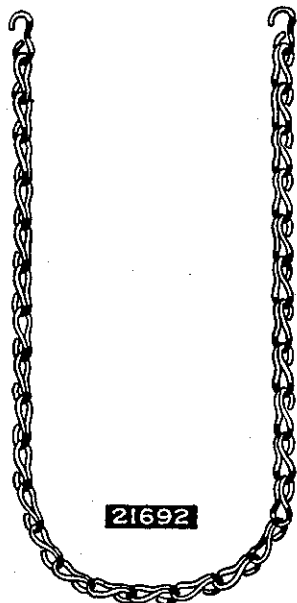

21692

Plate 28—One-eighth Size

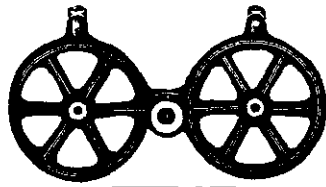

21130 A-2



21104 D



21104 F



21104 K



21104 A



21173 A



21173 B



21104 G



69 S

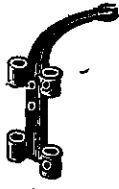

70

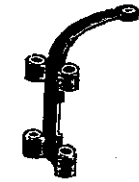

902

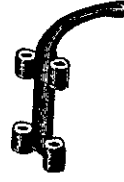

1935



413

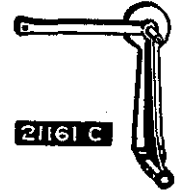

21161 C



3



12



21161 D

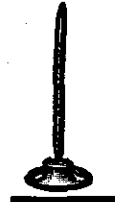

21169 F

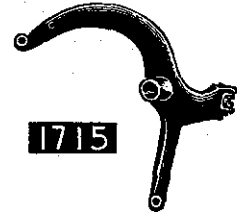

1715

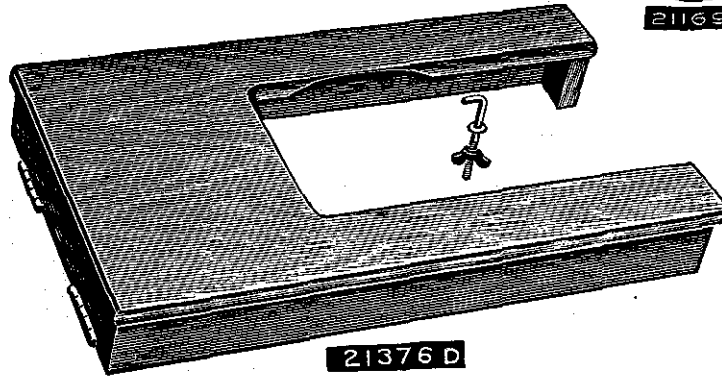

21376 D



1215 A

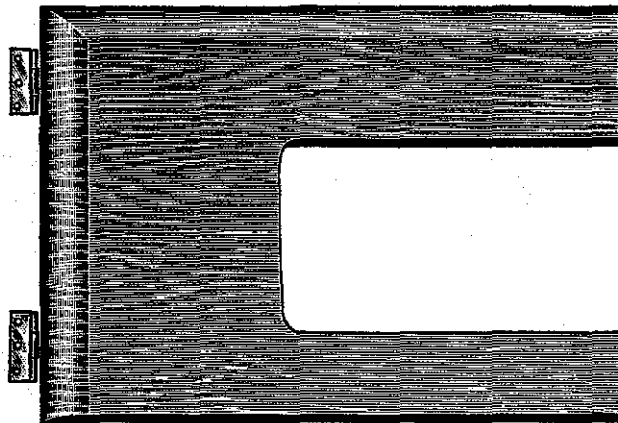

21376 C



2315 A



2515 A

Plate 29—One-eighth Size

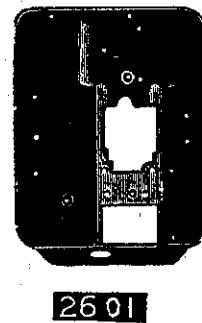
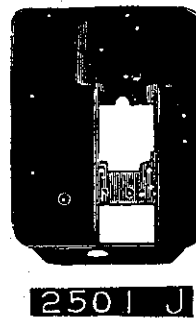
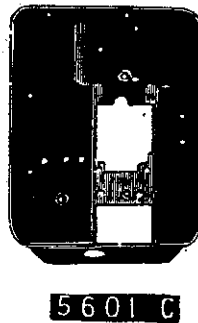
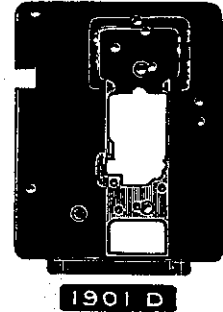
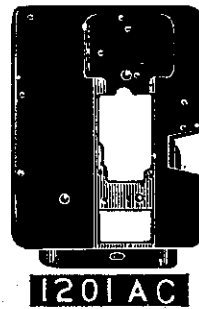
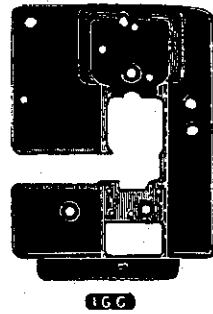
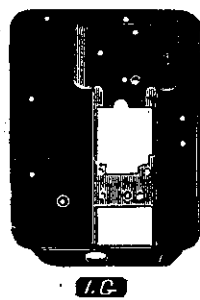
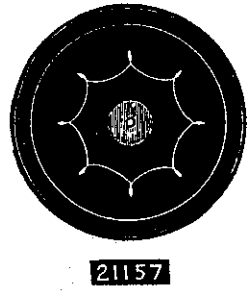
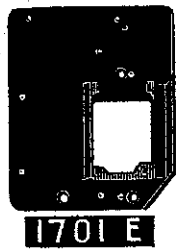
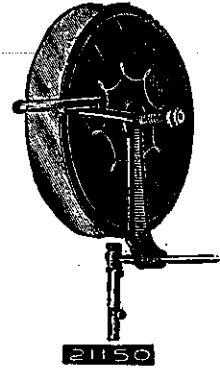
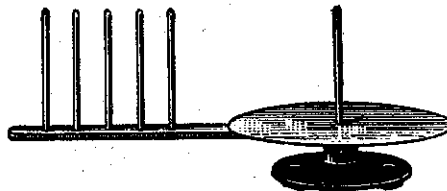
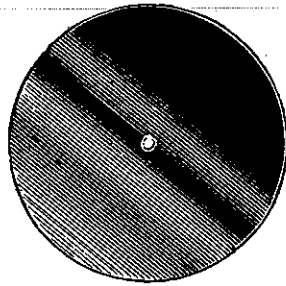
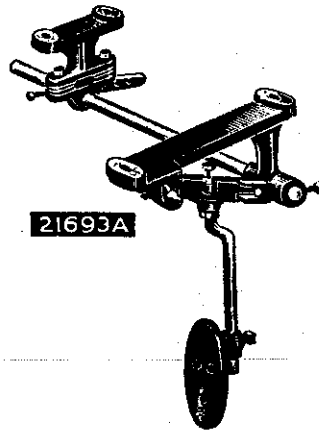
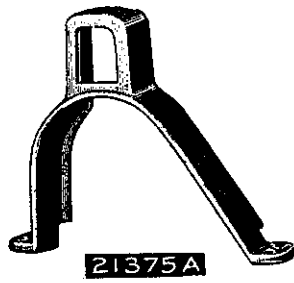

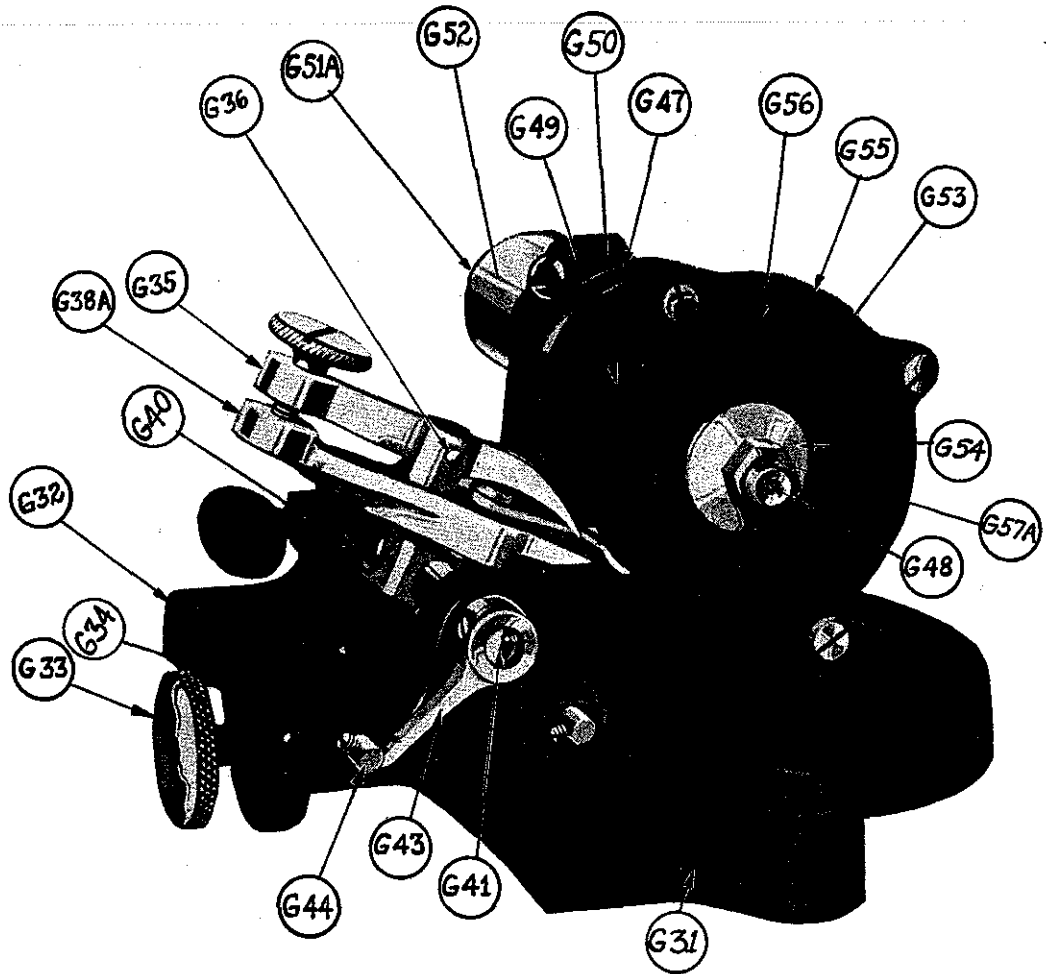

2375A
Toggle Grinder Assembly

LIST OF PARTS

Symbol to Order by	The figures in the last column refer only to the plates illustrating the parts and are not to be used in ordering.	Plate No.
1 G	Cloth Plate, for Styles 1200 A, 1200 C, 1200 G, 1200 O, 1200 Q, 1200 AD, 1700 A, 1700 B, 1700 F, 1700 H, 2600 F, 2600 G, 2600 J.....	29
1 GC	Cloth Plate, for styles in Class 2300.....	29
2	Cloth Plate Screws No. 80. Cloth Plate Slide, right, for Styles 1200 A, 1200 AC, 1200 AD, 2600 J.....	21
2 A	Cloth Plate Slide Stop, Screw No. 150. Cloth Plate Slide, left; also cloth plate slide, right, for Styles 1200 C, 1200 G, 1200 O, 1200 Q, 1700 A, 1700 B.....	21
2 C	Cloth Plate Slide, right, for styles in Class 2300.....	21
2 S	Cloth Plate Slide, right, for Styles 1700 F, 1700 H, 2600 F, 2600 G, 2600 H.....	21
2 U	Cloth Plate Slide Thumbscrew No. 25 T. Cloth Plate Hinged Cover Latch.....	19
2 CU	Cloth Plate Hinged Cover Latch Screw No. 134. Cloth Plate Slide, right, for Style 1900 K.....	21
3	Cloth Plate Slide Stop Screw No. 150. Cloth Plate Guard, for styles in Classes 1700, 2300; also for Styles 1200 A, 1200 C, 1200 G, 1200 O, 1200 Q, 1200 AC, 1900 K, 2600 F, 2600 G, 2600 H, 2600 J.....	28
4 B	Cloth Plate Guard Screw, front, No. 92 A. Cloth Plate Guard Screw, rear, No. 92. Cast-off Wire, for Styles 1200 A, 1200 C, 1200 G, 1200 O, 1200 Q, 1700 A, 1700 B.....	13
4 C	Cast-off Wire, for Styles 1200 AA, 1200 AD, 1700 G, 2600 J, 5600 C, 5800 C, 5800 H, 5800 J.....	13
4 E	Cast-off Wire for Styles in Class 2300.....	13
4 V	Cast-off Wire for Styles 2600 A, 2600 D, 2600 F, 2600 G, 2600 H.....	13
5	Cast-off Wire Screw No. 22524. Main Shaft Collar.....	16
T5	Main Shaft Collar Screws No. 95. Lower Toggle Adjusting Wedge, for styles in Class 2300.....	11
6 B	Looper Eccentric Fork Shoe.....	12
6 E	Looper Eccentric Fork Shoe Screw No. 94. Looper Eccentric Fork.....	22
T6	Looper Eccentric Fork Set Screws No. 72. Looper Eccentric Fork Clamp Screw No. 85. Lower Toggle Adjusting Wedge Nut.....	11
7	Feed Rocker, non-floating design, for Styles 2600 F, 2600 G, 2600 H.....	22
7 C	Feed Rocker, for Styles 2300 A, 2300 B, 2300 M, 2300 N....	28
7 G	Feed Rocker, floating design, for styles in Classes 1700, 2600, 5800, also Styles 1200 A, 1200 C, 1200 G, 1200 O, 1200 Q, 1200 AC, 1200 AD, 1900 K.....	27
	Feed Rocker Screws No. 88.	

LIST OF PARTS

Symbol to Order by	The figures in the last column refer only to the plates illustrating the parts and are not to be used in ordering.	Plate No.
7 H	Feed Rocker Arm, for use with feed rocker No. 7 G	27
	Feed Rocker Arm Screws No. 93.	
T7	Lower Toggle Adjusting Wedge Pin, for styles in Class 2300	16
8	Feed Rocker Shaft, solid, $5\frac{3}{16}$ inches long, hardened and ground, standard diameter .407 inch, for styles with non- floating design feed rocker	23
8-408	Feed Rocker Shaft, standard diameter plus .001 inch	—
8-410	Feed Rocker Shaft, standard diameter plus .003 inch	—
8-413	Feed Rocker Shaft, standard diameter plus .006 inch	—
8-416	Feed Rocker Shaft, standard diameter plus .009 inch	—
8-419	Feed Rocker Shaft, standard diameter plus .012 inch	—
8-422	Feed Rocker Shaft, standard diameter plus .015 inch	—
8 A	Feed Rocker Shaft, $5\frac{5}{8}$ inches long, for styles with floating design feed rocker	23
9 C	Feed Bar, for Styles 2300 A, 2300 B, 2300 M, 2300 N	25
9 X	Feed Bar, for Styles 1200 C, 1200 G, 1200 O, 1200 Q, 1200 AC, 1200 AD, 1700 A, 1700 B, 1700 F, 1700 G, 2600 F, 2600 G, 2600 H	22
	Feed Bar Screws No. 88.	
10	Feed Bar Prong and Sponge, for styles in Class 1700; also Styles 1200 A, 1200 C, 1200 G, 1200 O, 1200 Q, 1200 AC, 1200 AD, 2300 A, 2300 B, 2300 M, 2300 N, 2600 F, 2600 G, 2600 H, 2600 J	24
	Feed Bar Prong Screws No. 94.	
10 A	Feed Bar Prong Sponge	—
11	Feed Bar Shaft, $3\frac{7}{8}$ inches long, hardened and ground, for styles with non-differential feed	23
T11	Lower Toggle, serrated one side, for Styles 2300 A, 2300 B, 2300 N, 2300 P, 2300 Q	4
T11 A	Lower Toggle, serrated both sides, for Styles 2300 M, 2300 R Lower Toggle Screw No. T12.	4
12	Feed Crank Cover, for Style 1700 G	28
	Feed Crank Cover Hinge Screw No. 14.	
T12	Screw, for lower toggles	10
13	Feed Crank Cover Spring, for Style 1700 G	24
	Feed Crank Cover Spring Screw No. 94.	
G13	Clamp Screw, for toggle grinder renewable bearing	10
T13	Lower Toggle Adjusting Bushing, long, for styles in Class 2300	16
T13 A	Lower Toggle Adjusting Bushing, short, for styles in Class 2300	16
14	Hinge Screw, for feed crank cover on Style 1700 G	11
T14	Lower Toggle Nut, for styles in Class 2300	11

LIST OF PARTS

Symbol to Order by	The figures in the last column refer only to the plates illustrating the parts and are not to be used in ordering.	Plate No.
15	Feed Crank Link, for styles in Classes 1200, 1700, 2300, 2600, 5600, 5800.....	15
	Feed Crank Link Shim No. 1248.	
	Feed Crank Link Screw, $\frac{3}{8}$ inch long, No. 22569.	
	Feed Crank Link Nut No. 7947.	
	Feed Crank Link Screw, $\frac{1}{8}$ inch long, No. 79, obsolete.	
16	Feed Crank Link Ferrule.....	16
G16	Toggle Grinder Emery Wheel.....	25
	Toggle Grinder Emery Wheel Washer No. G54.	
	Toggle Grinder Emery Wheel Nut No. G57 A.	
T16	Trimmer Pitman Pin, for styles in Class 2300.....	16
	Trimmer Pitman Pin Screw No. 77.	
17	Feed Crank Stud, for styles in Classes 1200, 1700, 2300, 2600, 5600, 5800.....	11
17 X	Feed Crank Stud, for Style 1900 K.....	10
18	Feed Crank Stud Nut; also for Nos. 36 R, 21168 A.....	11
T18	Trimmer Pitman Screw, front, for styles in Class 2300.....	10
19	Feed Crank Stud Cap, for styles in Classes 1200, 1700, 2300, 2600, 5600, 5800.....	12
	Feed Crank Stud Cap Screws No. 77.	
T19	Trimmer Pitman Bracket, for Styles 2300 A, 2300 B, 2300 M, 2300 N.....	25
	Trimmer Pitman Bracket Screws No. 22548.	
20	Feed Crank Stud Washer; also for No. 21168 A.....	14
21	Feed Crank Link Pin.....	16
	Feed Crank Link Pin Screw No. 77.	
T21	Upper Toggle, for Styles 2300 B, 2300 Q.....	4
T21 A	Upper Toggle, $\frac{5}{8}$ inch long, with three teeth, for styles in Class 2300.....	4
T21 B	Upper Toggle, for Styles 2300 A, 2300 N, 2300 P.....	4
	Upper Toggle Screw No. T22.	
22	Feed Dog, for Style 1200 O.....	6
22 D	Feed Dog, for Styles 1200 G, 1200 Q, 1700 F, 2600 F, 2600 H	6
22 E	Feed Dog, for Styles 1700 A, 1700 B, 2600 J.....	6
22 I	Feed Dog, for Styles 1200 A, 1200 C, 1200 AD.....	6
22 L	Feed Dog, for Styles 2300 A, 2300 B, 2300 N.....	6
22 Y	Feed Dog, for Style 1700 H.....	6
	Feed Dog Screw No. 93.	
T22	Upper Toggle Screw, for styles in Class 2300.....	10
T23	Upper Toggle Guide Screw.....	10
24	Gauge, for Styles 1200 A, 1200 C, 1200 G, 1200 Q.....	20
24 A	Gauge, for Style 1200 O.....	20
	Gauge Screws No. 25.	
24 S	Gauge, for Styles 1700 F, 1700 H, 2600 A, 2600 F, 2600 G	20
	Gauge Screw No. 25 S.	
25	Thumbscrew, for cloth plate gauges.....	10

LIST OF PARTS

Symbol to Order by	The figures in the last column refer only to the plates illustrating the parts and are not to be used in ordering.	Plate No.
25 B	Screw, for loop retainer in Styles 2600 A, 2600 D, 2600 F, 2600 G, 2600 H.....	9
25 C	Screw, $\frac{9}{32}$ inch long, for cloth plate attachments.....	9
25 S	Screw, for cloth plate slide gauges; also for No. 21163.....	9
25 T	Thumbscrew, for cloth plate slides.....	10
25 CC	Screw, for cloth plate hinged cover; also for Nos. 396 D, 2392.	9
T25	Upper Toggle Adjusting Block, for styles in Class 2300.....	12
	Upper Toggle Adjusting Block Guide Screws No. T26.	
26	Looper, for styles in Class 2300; also Styles 1200 A, 1200 C, 1200 G, 1200 O, 1200 Q, 1700 A, 1700 B.....	8
26 V	Looper, without guard, otherwise same as No. 26 VN.....	8
26 VN	Looper, with guard, for Styles 2600 A, 2600 D, 2600 F, 2600 G, 2600 H.....	8
	Looper Set Screw No. 73.	
A26	Looper Needle Guard, for loopers Nos. 26 VN, 5807, 6207 B..	8
	Looper Needle Guard Screw No. 73 A.	
T26	Guide Screw, for upper toggle adjusting block, on styles in Class 2300.....	9
27 V	Loop Retainer, for Styles 2600 A, 2600 D, 2600 F, 2600 G, 2600 H.....	13
	Loop Retainer Screw No. 25 B.	
	Loop Retainer Adjusting Screw, $\frac{3}{32}$ inch long, No. 28 B.	
27 X	Loop Retainer, for Style 1900 K.....	13
	Loop Retainer Screw No. 87 U.	
	Loop Retainer Adjusting Screw No. 1096.	
T27	Upper Toggle Adjusting Wedge, for styles in Class 2300....	11
	Upper Toggle Adjusting Wedge Nut No. T29.	
	Upper Toggle Adjusting Wedge Set Screw No. 22570.	
28 B	Adjusting Screw, $\frac{3}{32}$ inch long, for loop retainer.....	9
29	Looper Rocker, hardened, for Style 1900 K.....	25
29 V	Looper Rocker, hardened, for Styles 1200 AC, 1200 AD, 1700 F, 1700 G, 2600 A, 2600 D, 2600 F, 2600 G, 2600 H....	25
T29	Upper Toggle Adjusting Wedge Nut, for styles in Class 2300.	11
30	Looper Rocker Frame, integral cone, hardened.....	22
	Looper Rocker Frame Screw, left, No. 88.	
	Looper Rocker Frame Screw, right, No. 98.	
	Looper Rocker Frame Spot Screw No. 96.	
T30	Upper Toggle Guide Screw Washer, for styles in Class 2300...	12
31	Looper Rock Shaft, $3\frac{1}{8}$ inches long, hardened and ground, standard diameter .407 inch.....	23
31-408	Looper Rock Shaft, standard diameter, plus .001 inch.....	—
31-410	Looper Rock Shaft, standard diameter, plus .003 inch.....	—
31-413	Looper Rock Shaft, standard diameter, plus .006 inch.....	—
31-416	Looper Rock Shaft, standard diameter, plus .009 inch.....	—
31-419	Looper Rock Shaft, standard diameter, plus .012 inch.....	—
31-422	Looper Rock Shaft, standard diameter, plus .015 inch.....	—
G31	Toggle Grinder Frame.....	30

LIST OF PARTS

Symbol to Order by	The figures in the last column refer only to the plates illustrating the parts and are not to be used in ordering.	Plate No.
32	Looper Rock Shaft, $1\frac{1}{8}$ inches long, hardened and ground, standard diameter, .407 inch.	23
32-408	Looper Rock Shaft, standard diameter, plus .001 inch.	—
32-410	Looper Rock Shaft, standard diameter, plus .003 inch.	—
32-413	Looper Rock Shaft, standard diameter, plus .006 inch.	—
32-416	Looper Rock Shaft, standard diameter, plus .009 inch.	—
32-419	Looper Rock Shaft, standard diameter, plus .012 inch.	—
32-422	Looper Rock Shaft, standard diameter, plus .015 inch.	—
G32	Toggle Grinder Frame Slide.	30
33	Looper Rocker Stud, hardened, $\frac{7}{32}$ inch diameter.	10
G33	Toggle Grinder Frame Slide Adjusting Screw.	30
34	Looper Rocker Stud Nut, for use with $\frac{7}{32}$ inch stud; also for No. 12993 A.	11
G34	Toggle Grinder Frame Slide Gib.	30
	Toggle Grinder Frame Slide Gib Screws No. 22575.	
35	Looper Connecting Rod, $6\frac{1}{4}$ inches long, for styles in Classes 2300, 5800; also Styles 1200 A, 1200 AD, 1700 G, 1900 K, 2600 A, 2600 D, 2600 F, 2600 G, 2600 H.	23
G35	Toggle Grinder Clamp.	30
	Toggle Grinder Clamp Screw No. 201 C.	
G36	Toggle Grinder Clamp Pivot Pin.	30
‡ 36 L	Looper Connecting Rod Ball Joint Assembly, left.	17
‡ 36 R	Looper Connecting Rod Ball Joint Assembly, right.	17
	Looper Connecting Rod Ball Joint Screws No. 97 A.	
37 L	Looper Connecting Rod Nut, left thread.	11
37 R	Looper Connecting Rod Nut, right thread.	11
38	Looper Eccentric, ground, for styles in Classes 2300, 5600; also Styles 1200 A, 1200 C, 1200 G, 1200 O, 1200 Q, 1700 A, 1700 B, 5800 C, 5800 H.	16
38 V	Looper Eccentric, ground, for Styles 1200 AA, 1200 AC, 1700 F, 1700 H, 1900 K, 2600 A, 2600 D, 2600 F, 2600 G, 2600 J.	16
	Looper Eccentric Screw No. 96.	
G38 A	Toggle Grinder Turn Table.	30
G39	Toggle Grinder Turn Table Pivot Stud.	10
	Toggle Grinder Turn Table Pivot Stud Nut No. 11638 M.	
40	Frame Looper Thread Guide, lower, right.	12
G40	Toggle Grinder Turn Table Tilting Block.	30
	Toggle Grinder Turn Table Tilting Block Screw No. 96.	
G41	Toggle Grinder Tilting Shaft.	30
41 A	Hand Lifter, hardened, for styles in Class 5800; also Styles 1200 A, 1200 C, 1200 G, 1200 O, 1200 Q, 1200 AA, 1200 AC, 1700 A, 1700 B, 1700 F, 1700 H, 1900 K, 2300 A, 2300 B, 2300 M, 2300 P, 2300 Q, 2300 R, 2600 F, 2600 G, 2600 H, 2600 J, 5600 C.	12
	Hand Lifter Stud No. 86.	

‡See Page 7

LIST OF PARTS

Symbol to Order by	The figures in the last column refer only to the plates illustrating the parts and are not to be used in ordering.	Plate No.
42 A	Hand Lifter Screw Pin, hardened.....	10
43	Feed Lift Eccentric, ground, for styles in Classes 1200, 5600; also Styles 1700 A, 1700 B, 1700 G, 2300 A, 2300 B, 2300 M, 2300 N.....	16
43 C	Feed Lift Eccentric, ground, for Styles 1700 F, 1700 H, 2600 F, 2600 G, 2600 H, 2600 J.....	16
43 X	Feed Lift Cam, hardened and ground, for Style 1900 K..... Feed Lift Cam Screw No. 96.	16
G43	Toggle Grinder Tilting Shaft Arm..... Toggle Grinder Tilting Shaft Arm Screw No. 96.	30
G44	Toggle Grinder Knife Clamp Stop Screw Support.....	30
G46	Toggle Grinder Turn Table Spring Pin.....	16
47	Needle Lever Stud Nut.....	11
G47	Toggle Grinder Pulley..... Toggle Grinder Pulley Screws No. 88.	30
48	Needle Lever Stud Washer.....	14
G48	Toggle Grinder Spindle, hardened and ground.....	30
G49	Toggle Grinder Spindle Renewable Bearing, lower, right....	30
50 D	Needle Bar, hardened and ground, standard diameter .257 inch, for styles in Classes 1700, 2300, 2600, 5600, 5800; also Styles 1200 C, 1200 G, 1200 O, 1200 Q, 1200 AA, 1200 AC, 1200 AD..... Needle Bar Set Screws, headless, No. 88. Needle Bar Set Screws, fillister head, No. 88 A.	23
G50	Toggle Grinder Spindle Renewable Bearing Cover, left..... Toggle Grinder Spindle Renewable Bearing Cover Screws No. 88.	30
51	Needle Bar Connection, for styles in Classes 1700, 2600, 5600, 5800; also Styles 1200 C, 1200 G, 1200 O, 1200 Q, 1200 AA, 1200 AC, 1200 AD, 1900 K.....	24
G51 A	Toggle Grinder Spindle Cap..... Toggle Grinder Spindle Cap Screws No. 88.	30
52 A	Needle Lever Thread Eyelet, for styles in Classes 1200, 1700, 2300, 5600, 5800; also Styles 1900 K, 2600 H, 2600 J and frame thread eyelet, for Styles 1900 K, 2600 A, 2600 D, 2600 F, 2600 G, 2600 H..... Thread Eyelet Screw No. 98 A.	13
G52	Toggle Grinder Spindle Collar..... Toggle Grinder Spindle Collar Screw No. 22560.	30
53 A	Needle Bar Thread Guide, for styles in Classes 1200, 1700, 2300, 5600, 5800; also Styles 1900 K, 2600 H, 2600 J..... Needle Bar Thread Guide Screw, for styles in Classes 1700, 2300, 5600, 5800, and Styles 1200 C, 1200 G, 1200 O, 1200 Q, 1200 AA, 1200 AC, 1200 AD, 1900 K, 2600 H, 2600 J, No. 22768. Needle Bar Thread Guide Screw, for Style 1200 A, No. 605 A.	13

LIST OF PARTS

Symbol to Order by	The figures in the last column refer only to the plates illustrating the parts and are not to be used in ordering.	Plate No.
G53	Toggle Grinder Spindle Oiler.....	30
54	Needle Lever Link, hardened.....	17
G54	Toggle Grinder Emery Wheel Washer.....	30
G55	Toggle Grinder Emery Wheel Guard, left	30
	Toggle Grinder Emery Wheel Guard Screws No. 531.	
56	Needle Clamp Nut, hardened.....	11
G56	Toggle Grinder Emery Wheel Guard, right.....	30
	Toggle Grinder Emery Wheel Guard Screws No. 93 A.	
57	Looper Thread Nipper Spring, upper.....	14
	Looper Thread Nipper Spring Screw No. 90.	
57 WB	Needle Bar Thread Nipper Plate.....	13
57 WC	Needle Bar Thread Nipper Spring.....	14
57 WD	Needle Bar Thread Nipper Stud; also for No. 15480 C.....	10
G57 A	Toggle Grinder Emery Wheel Nut.....	30
58	Looper Thread Nipper Spring, lower.....	14
	Looper Thread Nipper Spring Screw No. 90.	
	Looper Thread Nipper Spring Operating Screw No. 97.	
59 V	Eccentric Pulley, throw .461 inch, for Styles 1200 AC, 1700 F.	18
59 X	Eccentric Pulley, throw .634 inch, for Style 1900 K.....	18
	Eccentric Pulley Screws No. 22597.	
60 A	Presser Bar, hardened and ground, standard diameter .319 inch, for styles in Classes 1200, 1700, 2300, 5600, 5800; also Styles 2600 F, 2600 G, 2600 H, 2600 J.....	23
60 A-322	Presser Bar, standard diameter, plus .003 inch.....	—
60 A-325	Presser Bar, standard diameter, plus .006 inch.....	—
60 A-328	Presser Bar, standard diameter, plus .009 inch.....	—
60 A-331	Presser Bar, standard diameter, plus .012 inch.....	—
60 A-334	Presser Bar, standard diameter, plus .015 inch.....	—
60 C	Presser Bar, hardened and ground, standard diameter .319 inch, for Styles 2600 A, 2600 D.....	23
60 X	Presser Bar, hardened and ground, standard diameter .319 inch, for Style 1900 K.....	23
60 X-322	Presser Bar, standard diameter, plus .003 inch.....	—
60 X-325	Presser Bar, standard diameter, plus .006 inch.....	—
60 X-328	Presser Bar, standard diameter, plus .009 inch.....	—
60 X-331	Presser Bar, standard diameter, plus .012 inch.....	—
60 X-334	Presser Bar, standard diameter, plus .015 inch.....	—
61 C	Presser Bar Connection, for styles in Classes 1200, 1700, 2300, 2600, 5600, 5800.....	15
	Presser Bar Connection Screw, front, No. 77.	
	Presser Bar Connection Screw, rear, No. 88.	
62	Presser Guide Bar, hardened and ground, standard diameter .319 inch, for Style 1900 K.....	23
62-322	Presser Guide Bar, standard diameter, plus .003 inch.....	—
62-325	Presser Guide Bar, standard diameter, plus .006 inch.....	—
62-328	Presser Guide Bar, standard diameter, plus .009 inch.....	—
62-331	Presser Guide Bar, standard diameter, plus .012 inch.....	—

LIST OF PARTS

Symbol to Order by	The figures in the last column refer only to the plates illustrating the parts and are not to be used in ordering.	Plate No.
62-334	Presser Guide Bar, standard diameter, plus .015 inch	—
62 A	Presser Guide Bar, hardened and ground, standard diameter .319 inch, for styles in Class 5800; also Styles 1200 AD, 2600 A, 2600 D.	23
62 A-322	Presser Guide Bar, standard diameter, plus .003 inch	—
62 A-325	Presser Guide Bar, standard diameter, plus .006 inch	—
62 A-328	Presser Guide Bar, standard diameter, plus .009 inch	—
62 A-331	Presser Guide Bar, standard diameter, plus .012 inch	—
62 A-334	Presser Guide Bar, standard diameter, plus .015 inch	—
62 C	Presser Guide Bar, hardened and ground, standard diameter .319 inch, for styles in Classes 1700, 2300, 5600; also Styles 1200A, 1200 C, 1200 G, 1200 O, 1200 Q, 1200 AA, 1200 AC, 2600 F, 2600 G, 2600 H, 2600 J.	23
62 C-322	Presser Guide Bar, standard diameter, plus .003 inch	—
62 C-325	Presser Guide Bar, standard diameter, plus .006 inch	—
62 C-328	Presser Guide Bar, standard diameter, plus .009 inch	—
62 C-331	Presser Guide Bar, standard diameter, plus .012 inch	—
62 C-334	Presser Guide Bar, standard diameter, plus .015 inch	—
63 A	Presser Spring, for Styles 1200 C, 1200 G, 1200 O, 1200 Q, 1700 A, 1700 B, 2300 A, 2300 B, 2300 P, 2300 Q, 5600 C.	25
63 B	Presser Spring, for styles in Classes 2600, 5800; also Styles 1200 A, 1200 AA, 1200 AC, 1700 F, 1700 H, 1900 K, 2300 M, 2300 N, 2300 R.	25
64	Presser Spring Rest.	24
	Presser Spring Rest Screw No. 88.	
64 A	Presser Spring Regulating Screw, for styles in Classes 1200, 1700, 2300, 2600, 5600, 5800.	10
64 B	Presser Spring Regulating Screw Lock Nut.	11
64 X	Presser Spring Regulating Screw, for Style 1900 K.	10
65	Presser Foot, for Style 1200 A.	7
65 A	Presser Foot, for Styles 1200 C, 1200 AD.	7
65 C	Presser Foot, for Styles 2300 A, 2300 B, 2300 M, 2300 N, 2300 P, 2300 Q.	7
65 F	Presser Foot, for Style 1200 O.	7
65 G	Presser Foot, for Style 1200 G.	7
65 H	Presser Foot, for Style 1200 Q.	7
65 L	Presser Foot, for Style 1700 B.	7
65 T	Presser Foot, for Style 2600 F.	7
	Presser Foot Clamp Screw No. 91.	
66	Main Shaft, hardened and ground, standard diameter .530 inch, for styles in Classes 1200, 1700, 2300, 2600, 5600, 5800	25
66-531	Main Shaft, standard diameter, plus .001 inch.	—
66-533	Main Shaft, standard diameter, plus .003 inch.	—
66-536	Main Shaft, standard diameter, plus .006 inch.	—
66-539	Main Shaft, standard diameter, plus .009 inch.	—
66-542	Main Shaft, standard diameter, plus .012 inch.	—

LIST OF PARTS

Symbol to Order by	The figures in the last column refer only to the plates illustrating the parts and are not to be used in ordering.	Plate No.
67	Main Shaft Sleeve, left, $1\frac{1}{8}$ inches long, for styles in Classes 1200, 1700, 5600; also Styles 2300 A, 2300 B, 2300 M, 2300 N, 2600 F, 2600 G, 2600 H, 2600 J.....	16
68	Main Shaft Sleeve, right, $1\frac{1}{8}$ inches long with lug.....	16
68 B	Main Shaft Sleeve, $1\frac{1}{8}$ inches long, without lug.....	16
69 S	Thread Stand Pin, 4 inches long, for styles in Classes 1200, 1700, 2300, 2600, 5600, 5800.....	28
<input type="checkbox"/> 69 FD	Screw, square head, cup point, $\frac{5}{16}$ inch diameter, 18 threads to inch, $\frac{5}{8}$ inch long, for thread stand seats; also for Nos. 21104 D, 21685, 21693 F, 21693 K.....	9
70	Looper Eccentric Sponge Holder and Sponge.....	24
	Looper Eccentric Sponge Holder Screw No. 93.	
70 A	Looper Eccentric Sponge.....	—
72	Set Screw, for looper eccentric fork.....	9
73	Set Screw, fillister head, for loopers.....	9
73 A	Screw, for looper needle guard, also for No. 1742.....	9
77	Screw, for feed crank stud caps; also for Nos. T16, 21, 61 C, 1286 A.....	9
78	Screw, lower, for needle lever link pin.....	9
79	Clamp Screw, for needle rear guard in Style 1200 AD.....	9
80	Screw, for cloth plates.....	9
82	Screw, for regulating length of stitch.....	9
84 A	Stitch Regulating Ferrule, for Styles 1200 AA, 2600 A, 2600 D, 2600 F, 2600 G, 2600 H, 5600 C, 5800 C, 5800 H, 5800 J.....	16
84 B	Stitch Regulating Ferrule, for styles in Classes 1700, 2300; also for Styles 1200 A, 1200 C, 1200 G, 1200 O, 1200 Q, 1200 AC, 1200 AD, 2600 J.....	16
85	Clamp Screw, for looper eccentric fork.....	9
86	Stud, for hand lifters; also for No. 403.....	10
86 A	Screw, plus size, for hand lifters, tap No. V113.....	10
87	Screw, for throat plates; also for Nos. 148 A, 196, 196 D, 9725, 21390 D.....	9
87 U	Screw, for needle thread take-up wire; also for Nos. 27 X, 2366 B, 2366 E, 5005 P, 5805 X, 5826 B, 5826 D, 21607, 21608.....	9
88	Screw, headless, for feed rockers; also for Nos. 30, G47, 50 D, G50, G51 A, 61 C, 64, 217, 406 B, 1288, 1917 K, 1920 K, 4517, 8648, 15063, 15465 F, 21113 B, 21161 D.....	9
88 A	Set Screw, fillister head, for needle bars; also for No. 6440.....	9
89	Screw, for looper thread take-ups.....	9
90	Screw, for looper thread nipper springs; also for Nos. 2305 P, 2305 R, 15447 L, 21390 E.....	9
91	Clamp Screw, for presser feet.....	9
92	Screw, rear, for cloth plate guard.....	9
92 A	Screw, front, for cloth plate guard.....	9

See page 7.

LIST OF PARTS

Symbol to Order by	The figures in the last column refer only to the plates illustrating the parts and are not to be used in ordering.	Plate No.
93	Screw, for feed dog in Styles 1200 C, 1200 G, 1200 O, 1200 Q, 1200 AC, 1200 AD, 1700 A, 1700 B, 1700 F, 1700 G, 2600 F, 2600 G, 2600 H, 2600 J and under feed dog in Styles 2600 A, 2600 D, 5800 C, 5800 H, 5800 J; also for Nos. 7 H, 70, 5150, 5650, 5842 A, 7638 A, 15447 F, 15447 K.....	9
93 A	Screw, for feed dog in Styles 1200 A, 1700 H, 1900 K, 2300 A, 2300 B, 2300 M, 2300 N; also for Nos. G56, 419 A, 911, 912, 1905 J, 2336, 5045, 15447 K.....	9
94	Screw, for looper eccentric fork shoe; also for Nos. 13, 104, 113, 113 A, 202 A, 404 A, 539, 1825, 1941, 2340, 5132, 9932, 21602.....	9
95	Screw, for main shaft collar; also for No. 1005.....	9
96	Screw, for looper eccentrics; also for Nos. 30, G40, 43, 43 C, 43 X, G43, 917, 2306.....	9
97	Screw, $\frac{1}{8}$ inch long, for supporting feed dogs; also for Nos. 58, 103, 403, 2334, 17158.....	9
97 A	Screw, for looper connecting rod ball joint assemblies.....	10
98	Screw, right, for looper rocker frame; also for Nos. 111, 334, 482, 2650, 21157.....	9
98 A	Screw, for needle lever thread eyelet; also for No. 21632....	9
99	Cloth Plate Slide, rear, for styles in Class 2300.....	21
100 B	Thread Stand Wire, 16 inches long, for styles in Classes 1200, 1700, 2300, 2600, 5600, 5800.....	27
	Thread Stand Wire Screw, headless, 24 threads to inch, No. 22813, obsolete.	
	Thread Stand Wire Screw, square head, 24 threads to inch, No. 22632 F-24.	
101	Looper Thread Take-up, for styles in Class 2300; also Styles 1200 A, 1200 C, 1200 G, 1200 O, 1200 Q, 1700 A, 1700 B, 2600 J.....	3
101 V	Looper Thread Take-up, for styles in Classes 5600, 5800; also Styles 1200 AA, 2600 A, 2600 D, 2600 F, 2600 G, 2600 H... Looper Thread Take-up Screw No. 89.	3
102	Looper Thread Take-up Eyelet Stand, for styles in Classes 1200, 1700, 2300, 2600, 5600, 5800.....	24
	Looper Thread Take-up Eyelet Stand Screws No. 22596.	
103	Looper Thread Take-up Eyelet, for styles in Classes 1200, 1700, 2300, 2600, 5600.....	24
	Looper Thread Take-up Eyelet Adjusting Screw No. 97.	
104	Looper Thread Take-up Eyelet Spring, for styles in Classes 1200, 1700, 2300, 2600, 5600, 5800.....	12
	Looper Thread Take-up Eyelet Spring Screw No. 94.	
105-1 $\frac{1}{2}$	Thumbscrew, 1 $\frac{1}{2}$ inches long, for fastening machine to table	18
105-2 $\frac{1}{2}$	Thumbscrew, 2 $\frac{1}{2}$ inches long.....	18
105-3	Thumbscrew, 3 inches long.....	18
105-3 $\frac{1}{2}$	Thumbscrew, 3 $\frac{1}{2}$ inches long.....	18
107	Tension Spring Ferrule.....	16

LIST OF PARTS

Symbol to Order by	The figures in the last column refer only to the plates illustrating the parts and are not to be used in ordering.	Plate No.
108	Tension Regulating Nut, knurled.....	11
109	Tension Disc, hardened and lapped.....	13
V109	Tap, marked "J2" for No. 22526.....	12
110-0	Tension Spring, .022 inch diameter wire, for looper thread on Styles 1200 AD, 1700 G.....	14
110-1	Tension Spring, .026 inch diameter wire, for looper thread on styles in Classes 2300, 2600, 5600, 5800; also Styles 1200 A, 1200 C, 1200 G, 1200 O, 1200 Q, 1200 AA, 1200 AC, 1700 A, 1700 B, 1700 F, 1700 H and for needle thread on Style 1900 K.....	14
110-2	Tension Spring, .028 inch diameter wire, for needle thread on Styles 2300 A, 2300 B, 2300 N, 2300 P, 2300 Q; also for No. 1000.....	14
110-3	Tension Spring, .040 inch diameter wire, for needle thread on Styles 1200 A, 1200 C, 1200 G, 1200 O, 1200 Q, 1200 AC, 1700 B, 1700 F, 1700 H, 2300 M, 2300 R, 2600 H, 2600 J... .	14
110-4	Tension Spring, .048 inch diameter wire, for needle thread on Styles 2600 A, 2600 D, 2600 F, 2600 G.....	14
111	Tension Thread Eyelet, with two eyes, for styles in Classes 1200, 1700, 2300, 2600, 5600, 5800.....	13
	Tension Thread Eyelet Screw No. 98.	
112	Throat Plate, for Styles 1200 A, 1200 C.....	1
112 C	Throat Plate, for Styles 2300 B, 2300 M.....	1
112 E	Throat Plate, for Style 1200 O.....	1
112 S	Throat Plate, for Styles 1200 G, 1200 Q.....	1
O112	Throat Plate, for Style 1700 H.....	1
112 CC	Throat Plate, for Style 2600 F.....	1
112 CN	Throat Plate, for Styles 2300 A, 2300 N.....	1
	Throat Plate Screws No. 87.	
113	Frame Thread Guide, adjustable, 2 $\frac{1}{4}$ inches long, for styles in Classes 2300, 5800.....	24
113 A	Frame Thread Guide, adjustable, 1 inch long, for Styles 1200 A, 1200 C, 1200 G, 1200 O, 1200 Q, 1200 AA, 1200 AC, 1700 A, 1700 B, 1700 F, 1900 K, 5600 C.....	24
	Frame Thread Guide Screw No. 22529.	
V113	Tap, marked "Q2", for No. 86 A.....	12
116	Wrench, $\frac{9}{32}$ inch, for needle clamp nut.....	20
118	Thread Hook, for looper threads.....	20
118 B	Thread Tweezers.....	20
V118	Tap, marked "X2", for plus size cloth plate screw No. 22521.	12
134	Screw, for cloth plate hinge cover latch.....	10
137	Needle Thread Controller Lever Eyelet, for Styles 1700 H, 2600 J.....	13
138	Screw, for needle thread controller lever eyelet.....	9
‡ 139 A	Needle Thread Controller Lever Assembly, for Styles 2600 A, 2600 D, 2600 F, 2600 G, 2600 H.....	20
141	Needle Thread Controller Lever Screw.....	9

‡ See page 7.

LIST OF PARTS

Symbol to Order by	The figures in the last column refer only to the plates illustrating the parts and are not to be used in ordering.	Plate No.
148 A	Throat Plate Needle Guard, hardened, for Styles 2600 A, 2600 D, 2600 F, 2600 G, 2600 H.....	11
	Throat Plate Needle Guard Screw No. 87.	
150	Stop Screw, for cloth plate slides.....	9
154	Needle Lever Buffer, wood fibre.....	12
156	Needle Lever Ball, hardened.....	10
161	Binding Holder Disc Supporting Collar, for Styles 5800 H, 5800 J.....	16
181	Looper Rocker, hardened, for styles in Class 2300.....	17
187 A	Screw, for binding guide adjustments.....	9
188 D	Set Screw, knurled head, for roller support swinging arm....	9
196	Throat Plate Needle Guard, hardened, for Styles 1700 A, 1700 B, 2600 J.....	11
196 D	Throat Plate Needle Guard, hardened, for Styles 1200 AC, 1700 F.....	11
	Throat Plate Needle Guard Screw No. 87.	
201 C	Screw, for toggle grinder clamp.....	10
202 A	Needle Thread Pull-off and Take-up Wire Post, for Styles 1200 AC, 1700 F, 1700 H.....	13
	Needle Thread Pull-off and Take-up Wire Post Screw No. 94.	
202 B	Needle Thread Take-up Wire, for Styles 1200 AC, 1700 F, 1700 H.....	13
	Needle Thread Take-up Wire Screw No. 87 U.	
213	Looper Rocker, hardened, for Styles 1200 A, 1200 C, 1200 G, 1200 O, 1200 Q, 1700 A, 1700 B, 1700 H, 2600 J.....	25
217	Needle Thread Controller Rack, for Styles 2600 A, 2600 D, 2600 F, 2600 G, 2600 H.....	24
	Needle Thread Controller Rack Screws No. 88.	
269	Trimmer Stand Adjusting Rod Lock Nut, left thread, for styles in Class 2300.....	11
303	Screw, hexagon head, for upper feed bar spring.....	9
334	Tension Thread Eyelet, with one eye, for Style 1900 K....	13
	Tension Thread Eyelet Screw No. 98.	
396 D	Welt Gauge Base, for Style 2600 D.....	19
	Welt Gauge Base Screws No. 25 CC.	
399 A	Welt Gauge Slide.....	19
400	Welt Gauge Slide Spring.....	19
401	Welt Gauge Slide Spring Screw.....	9
402	Welt Gauge Slide Screw Pin, hardened; also for No. 410 A..	10
403	Welt Gauge Slide Lever.....	19
	Welt Gauge Slide Lever Stud No. 86.	
	Welt Gauge Slide Lever Screw No. 97.	
404 A	Welt Gauge Slide Lever Stop Plate.....	19
	Welt Gauge Slide Lever Stop Plate Screws No. 94.	
406 B	Welt Guide, adjustable.....	19
407 A	Welt Guide Screw; also for No. 409 A.....	9
	Welt Guide Height Adjusting Screw No. 88.	

LIST OF PARTS

Symbol to Order by	The figures in the last column refer only to the plates illustrating the parts and are not to be used in ordering.	Plate No.
409 A	Welt Guide Tongue, adjustable	19
	Welt Guide Tongue Screw No. 407. A.	
410 A	Flexible Guide	19
	Flexible Guide Screw Pin No. 402.	
413	Oil Can, with spout	28
415 B	Lifter Lever Casting, for styles in Classes 2600, 5800; also Styles 1200 A, 1200 C, 1200 G, 1200 AA, 1200 AC, 1200 AD, 1700 F, 1700 H, 1900 K, 2300 N, 2300 R.	20
419 A	Lifter Lever Extension	20
	Lifter Lever Extension Screws No. 93 A.	
420	Lifter Lever Stud	10
421	Lifter Lever Chain	20
423	Lifter Treadle Rest	24
424	Lifter Treadle Pin	23
	Lifter Treadle Pin Set Screw, 24 threads to inch, No. 22813.	
	Lifter Treadle Pin Set Screw, 32 threads to inch, No. 98, obsolete.	
426	Lifter Lever Spring	14
426 A	Lifter Lever Spring Pin	16
426 B	Lifter Lever Stop Pin	24
427	Binding Holder Disc, 6 inches diameter, for Style 5600 C.	29
430	Binding Holder Axle, for Styles 2600 H, 5600 C.	11
431 A	Binding Holder Spring Latch	4
432	Binding Holder Tension Spring	14
433	Binding Holder Tension Nut, knurled	10
434	Binding Holder Tension Lock Nut, knurled	11
482	Collar, for floating design feed rocker shaft on styles in Classes 1700, 2600, 5800; also Styles 1200 A, 1200 C, 1200 G, 1200 O, 1200 Q, 1200 AC, 1200 AD, 1900 K.	24
	Collar Screw No. 98.	
Y500-257	Expansion Reamer, for needle bars, size .257 inch	26
Y500-260	Expansion Reamer, size .260 inch	—
Y500-263	Expansion Reamer, size .263 inch	—
Y500-266	Expansion Reamer, size .266 inch	—
Y500-270	Expansion Reamer, size .270 inch	—
Y500-273	Expansion Reamer, size .273 inch	—
Y502-319	Expansion Reamer, for presser bars and presser guide bars, size .319 inch	26
Y502-322	Expansion Reamer, size .322 inch	—
Y502-325	Expansion Reamer, size .325 inch	—
Y505-407	Expansion Reamer, for feed rocker shafts and feed bar shaft, size .407 inch	26
Y505-410	Expansion Reamer, size .410 inch	—
Y505-413	Expansion Reamer, size .413 inch	—
Y506-530	Expansion Reamer, for main shafts, size .530 inch	26
Y506-533	Expansion Reamer, size .533 inch	—

LIST OF PARTS

Symbol to Order by	The figures in the last column refer only to the plates illustrating the parts and are not to be used in ordering.	Plate No.
Y510-200	Expansion Reamer, for needle bars, size .200 inch	26
531	Screw, for toggle grinder emery wheel guard, left	9
539	Frame Thread Eyelet, adjustable, for Styles 1200 AD, 1700 G. Frame Thread Eyelet Screw No. 94.	24
540	Frame Thread Eyelet Guide Pin	16
605	Screw, for presser foot spring on Style 1900 K	9
605 A	Screw, for needle bar thread guide, on Style 1200 A	9
<input type="checkbox"/> 650-10	Stove Bolt, flat head, $\frac{1}{4}$ x $1\frac{1}{4}$ inches, for knee lifter shaft hanger, rear	—
<input type="checkbox"/> 650-24	Stove Bolt, flat head, $\frac{1}{4}$ x 3 inches	—
<input type="checkbox"/> 660-31	Ball, .0625 inch diameter, for rolling presser foot	—
Y800	Taper Reamer, for lever end of needle lever stud	—
Y801	Taper Reamer, for frame end of needle lever stud	—
Y802	Taper Reamer, for needle lever link pins and feed crank link pin	26
900	Cloth Plate Slide, right, for Style 2600 A	21
901	Cloth Plate Slide, right, for Style 2600 D	21
902	Feed Rocker, non-floating design, for Styles 2600 A, 2600 D, 5800 C, 5800 H, 5800 J	28
	Feed Rocker Screws No. 88.	
903	Feed Bar, for under feed, in Styles 2600 A, 2600 D, 5800 C, 5800 H, 5800 J	22
	Feed Bar Screws No. 88.	
904	Feed Bar, for upper feed, in Styles 2600 A, 2600 D, 5800 C, 5800 H, 5800 J	22
905	Upper Feed Bar Spring, for Styles 2600 A, 2600 D, 5800 C, 5800 H, 5800 J	20
	Upper Feed Bar Spring Screw No. 303.	
906	Adjusting Screw, hexagon head, for upper feed bar spring, in Styles 2600 A, 2600 D, 5800 C, 5800 H, 5800 J	9
906 A	Adjusting Screw, hexagon head, for upper feed dog on Styles 2600 A, 2600 D	9
907	Upper Feed Dog Adjusting Screw Lock Nut; also for No. 906	11
908	Feed Bar Prong and Sponge, for Styles 2600 A, 2600 D, 5800 C, 5800 H, 5800 J	24
	Feed Bar Prong Screws No. 94.	
911	Upper Feed Dog, for Styles 2600 A, 2600 D	6
	Upper Feed Dog Screw No. 93 A.	
912	Upper Feed Dog Holder, for Styles 2600 A, 2600 D	15
	Upper Feed Dog Holder Screws No. 93 A.	
917	Feed Lift Eccentric, ground, for Styles 2600 A, 2600 D, 5800 C, 5800 H, 5800 J	24
	Feed Lift Eccentric Screw No. 96.	
918	Presser Foot, for Style 2600 A	7
919	Presser Foot, for Style 2600 D	7
	Presser Foot Clamp Screw No. 91.	

See page 7.

LIST OF PARTS

Symbol to Order by	The figures in the last column refer only to the plates illustrating the parts and are not to be used in ordering.	Plate No.
920	Main Shaft Sleeve, left, $\frac{3}{8}$ inch long, for Styles 2600 A, 2600 D, 5800 C, 5800 H, 5800 J.....	16
1000	Thread Lubricator Assembly, for Styles 2600 A, 2600 D, 2600 F, 2600 G, 2600 H.....	17
1002	Thread Lubricator Cup.....	17
1003	Thread Lubricator Cup Pin.....	—
1004	Thread Lubricator Cup Felt.....	17
1005	Thread Lubricator Bracket.....	17
	Thread Lubricator Bracket Screw No. 95.	
1007	Thread Lubricator Tension Plate.....	12
	Thread Lubricator Tension Post No. 1346.	
	Thread Lubricator Tension Post Ferrule No. 1347.	
	Thread Lubricator Tension Spring No. 110-2.	
	Thread Lubricator Tension Spring Ferrule No. 107.	
	Thread Lubricator Tension Regulating Nut No. 108.	
1008	Thread Lubricator Tension Felt, lower.....	12
1054	Looper Eccentric, ground, for Styles 2600 H, 5800 J.....	16
	Looper Eccentric Screw No. 96.	
1059	Screw, for adjusting yielding guide on Style 1700 A.....	9
1096	Adjusting Screw, for loop retainer in Style 1900 K.....	9
1201 AC	Cloth Plate, for Style 1200 AC.....	29
	Cloth Plate Screws No. 80.	
1205 C	Main Feed Dog, for Style 1200 AA.....	5
	Main Feed Dog Screw No. 22593.	
1215 A	Needle Lever, for Styles in Classes 5600, 5800; also Styles 1200 A, 1200 C, 1200 G, 1200 O, 1200 Q, 1200 AA, 1200 AC, 1700 A, 1700 B, 1700 F, 1700 H, 2600 J.....	28
1216 B	Needle Lever Connecting Rod Assembly, wick feed oiling; one each Nos. 1230 A, 1230 B, 1230 C, 1230 D, 15430 C, 15430 D, 15430 M, 22586 A.....	17
1216 C	Needle Lever Connecting Rod Assembly, wick and splash feed oiling; one each Nos. 1230 A, 1230 B, 1230 C, 1230 D, 1230 G, 15430 C, 15430 D, 22586 A, and two No. 41046 G.	17
1220 AA	Presser Foot, for Style 1200 AA.....	7
1220 AC	Presser Foot, for Style 1200 AC.....	7
	Presser Foot Clamp Screw No. 91.	
1221	Eccentric Pulley, throw .529 inch, for Styles in Classes 2300, 5600, 5800; also Styles 1200 A, 1200 C, 1200 G, 1200 O, 1200 Q, 1200 AA, 1700 A, 1700 B, 1700 H, 2600 J..	18
	Eccentric Pulley Screws No. 22597.	
1228 A	Throat Plate, for Style 1200 AD.....	1
	Throat Plate Screws No. 87.	
†1230 A	Needle Lever Connecting Rod Upper Bearing.....	17
	Needle Lever Connecting Rod Upper Bearing Screws No. 22587.	
1230 B	Needle Lever Connecting Rod Upper Bearing Valve spring..	14

† See page 7.

LIST OF PARTS

Symbol to Order by	The figures in the last column refer only to the plates illustrating the parts and are not to be used in ordering.	Plate No.
1230 C	Needle Lever Connecting Rod Tube..... Needle Lever Connecting Rod Tube Nut, left thread, No. 15430 C. Needle Lever Connecting Rod Tube Nut, right thread, No. 15430 D.	17
1230 D	Needle Lever Connecting Rod Upper Bearing Valve..... Needle Lever Connecting Rod Upper Bearing Valve Screw No. 22586 A.	16
‡ 1230 G	Needle Lever Connecting Rod Lower Bearing, splash feed oiling, for styles in Classes 1200, 1700, 2300, 2600, 5600, 5800..... Needle Lever Connecting Rod Lower Bearing Screws No. 22587.	17
1248	Feed Crank Link Shim, leather.....	12
1261	Looper Rocker Frame, without cone..... Looper Rocker Frame Screw, left, No. 88. Looper Rocker Frame Screw, right, No. 98. Looper Rocker Frame Spot Screw No. 96.	22
1275 A	Needle Lever Stud, standard diameter.....	20
1275 E	Needle Lever Stud, plus size on <i>frame</i> section, viz.: .001, .002, .003, .006, .012, .018 inch; specify plus amount. Example: 1275 E-003 represents a stud plus .003 inch on <i>frame</i> section.....	—
1275 F	Needle Lever Stud, plus size on <i>lever</i> section, viz.: .001, .002, .003, .006 inch; specify plus amount. Example: 1275 F-003 represents a stud plus .003 inch on <i>lever</i> section.....	—
1275 H	Needle Lever Stud, plus size equal on <i>each</i> section; viz.: .001, .002, .003, .006 inch; specify plus amount. Example: 1275 H-003 represents a stud plus .003 inch on <i>each</i> section.....	—
1275 J	Needle Lever Stud, plus size unequal on each section, viz.: (.001, .002) (.001, .003) (.001, .006) (.002, .001) (.002, .003) (.002, .006) (.003, .001) (.003, .002) (.003, .006) (.006, .001) (.006, .002) (.006, .003) (.012, .001) (.012, .002) (.012, .003) (.012, .006) (.018, .001) (.018, .002) (.018, .003) (.018, .006) Specify plus amounts, arranged <i>frame</i> section first and <i>lever</i> section last. Example: 1275 J-003-006 represents a stud plus .003 inch on <i>frame</i> section and .006 inch on <i>lever</i> section, 1275 J-006-003 represents a stud plus .006 inch on <i>frame</i> section and .003 inch on <i>lever</i> section..... Needle Lever Stud Screw No. 22586. Needle Lever Stud Felt No. 15430 L. Note: Before lapping the bearing of a needle lever and a needle lever stud remove the felt from the stud and replace it after the lapping compound has been washed out.	—

‡See page 7.

LIST OF PARTS

Symbol to Order by	The figures in the last column refer only to the plates illustrating the parts and are not to be used in ordering.	Plate No.
1280	Needle Lever Ball Clamp Bolt Nut, also for No. 15745 B...	11
1286	Needle Lever Link Pin Assembly, internal oiling, hardened and ground, one each Nos. 1286 A, 1286 B, 12964 C, 22560; also for No. 15446 D.....	16
1286 A	Needle Lever Link Pin..... Needle Lever Link Pin Set Screw, upper, No. 77. Needle Lever Link Pin Set Screw, lower, No. 78. Needle Lever Link Pin Ball No. 12964 C.	16
1286 B	Needle Lever Link Pin Spring.....	14
1287	Needle Bar Thread Nipper Assembly, for use with .257 inch needle bars.....	13
1288	Needle Bar Thread Nipper Collar..... Needle Bar Thread Nipper Collar Screw No. 88.	13
1346	Tension Post, length overall $1\frac{1}{8}$ inches, for use with hard- ened steel ferrule.....	11
1347	Tension Post Ferrule, hardened.....	16
1349	Tension Spring, .036 inch diameter wire, for needle threads, on styles in Classes 5600, 5800 and Styles 1200 AA, 1700 A; also for No. 23285 A- $\frac{1}{2}$, 23285 A- $\frac{5}{8}$, 23285 A- $\frac{3}{4}$	14
1361 A	Presser Spring Pin.....	16
1362	Main Shaft Sleeve Pin.....	16
1520 M-13	Rolling Presser Foot Assembly, diameter of roller $\frac{1}{8}$ inch ball bearing design, universal adjustment, for Style 2600 J.....	8
1520 M-21	Rolling Presser Foot Assembly, diameter of roller $1\frac{5}{8}$ inches, ball bearing design, universal adjustment, for Style 2600 G.....	8
1580 G-13	Roller, ball bearing design, $\frac{1}{8}$ inch diameter, $\frac{3}{8}$ inch face, for Style 2600 J.....	—
1580 G-21	Roller, $1\frac{5}{8}$ inches diameter, $\frac{3}{8}$ inch face, for Style 2600 G. Roller Axle Screw No. 22818. Roller Axle Lock Screw No. 22743.	—
1584	Roller Support, adjustable..... Roller Support, Set Screw, hexagon head, No. 22519.	—
1592 B	Roller Support Swinging Arm, adjustable..... Roller Support Swinging Arm Set Screw, knurled head, No. 188 D. Roller Support Swinging Arm Stop Screw No. 22575. Roller Support Swinging Arm Hinge Pin No. 1594 A.	—
1592 C	Roller Support Swinging Arm Bracket, lower, adjustable... Roller Support Swinging Arm Bracket Screw No. 22548.	—
1593 C	Roller Support Swinging Arm Bracket, upper..... Roller Support Swinging Arm Bracket Set Screws No. 22584.	—
1593 E	Roller Support Swinging Arm Bracket, intermediate, ad- justable..... Roller Support Swinging Arm Bracket Screw No. 22548.	—

LIST OF PARTS

Symbol to Order by	The figures in the last column refer only to the plates illustrating the parts and are not to be used in ordering.	Plate No.
1594 A	Roller Support Swinging Arm Hinge Pin	—
1701 E	Cloth Plate, for Style 1700 G	29
	Cloth Plate Screws No. 80.	
1702	Cloth Plate Slide, right, for Style 1700 G	21
1704	Cast-off Wire, for Styles 1200 AC, 1700 F, 1700 H	13
	Cast-off Wire Screw No. 22524.	
1705	Feed Dog, for Style 1700 G	5
	Feed Dog Screw No. 93.	
1707 G	Looper, with guard, for Styles 1200 AD, 1700 G	8
1708 G	Looper, without guard, otherwise same as No. 1707 G	—
	Looper Set Screw No. 73.	
1715	Needle Lever, for Styles 1200 AD, 1700 G	28
1720 B	Presser Foot, for Style 1700 G	7
	Presser Foot Clamp Screw No. 91.	
1721	Eccentric Pulley, throw .389 inch, for Styles 1200 AD, 1700 G	18
	Eccentric Pulley Screws No. 22597.	
1724 A	Throat Plate, for Style 1700 G	3
1724 F	Throat Plate, for Style 1700 F	3
	Throat Plate Screws No. 87.	
1727 A	Presser Foot, for Styles 1700 F, 1700 H	7
1727 D	Presser Foot, for Style 1700 A	7
	Presser Foot Clamp Screw No. 91.	
1728	Throat Plate, for Style 1700 B	2
1728 D	Throat Plate, for Style 1700 A	2
	Throat Plate Yielding Guide No. 1742.	
	Throat Plate Yielding Guide Screw No. 73 A.	
	Throat Plate Yielding Guide Adjusting Screw No. 1059.	
	Throat Plate Screws No. 87.	
1731	Presser Spring, for Styles 1200 AD, 1700 G	19
1741 B	Presser Foot Chain Knife, for Styles 1700 F, 1700 H	12
	Presser Foot Chain Knife Screw No. 187 A.	
1742	Throat Plate Yielding Guide, for Style 1700 A	16
1749	Tension Spring, .040 inch diameter wire, for needle threads on Styles 1200 AD, 1700 G	14
1755	Hand Lifter, hardened, for Style 1700 G	18
	Hand Lifter Stud No. 86.	
1825	Feed Bar Needle Rear Guard, hardened, for Style 1900 K.	11
	Feed Bar Needle Rear Guard Screw No. 94.	
1825 A	Needle Rear Guard, for Style 1200 AD	12
	Needle Rear Guard Clamp Screws No. 79.	
1859	Needle Guard Stand	20
	Needle Guard Stand Screws No. 22596.	
1901 D	Cloth Plate, for Style 1900 K	29
	Cloth Plate Screws No. 80.	

LIST OF PARTS

Symbol to Order by	The figures in the last column refer only to the plates illustrating the parts and are not to be used in ordering.	Plate No.
1903 J	Swing Gauge Assembly, attaches to cloth plate, for Style 1900 K..... Edge Guide No. 1931 C. Edge Guide Thumbscrew No. 22756. Edge Guide Swinging Arm No. 1931 A. Edge Guide Swinging Arm Pivot Stud No. 22726. Edge Guide Swinging Arm Pivot Stud Spring Washer No. 12957 E.	19
1903 K	Edge Guide Swinging Arm Base No. 1931 B. Swing Gauge Assembly Screws No. 22514. Swing Gauge Assembly Screw Washers No. 9255. Swing Gauge Assembly, attaches to cloth plate slide, for Style 1900 K..... Edge Guide No. 1931. Edge Guide Thumbscrew No. 22756. Edge Guide Swinging Arm No. 1931 A. Edge Guide Swinging Arm Pivot Stud No. 22726. Edge Guide Swinging Arm Pivot Stud Spring Washer No. 12957 E. Edge Guide Swinging Arm Base No. 1931 B. Swing Gauge Assembly Screws No. 25 S. Swing Gauge Assembly Screw Washers No. 9255.	—
1905 J	Feed Dog, for Style 1900 K.....	5
1905 L	Feed Dog, for Style 1900 K, with gauge attached to cloth plate slide.....	—
1908 A	Feed Dog Screw No. 93 A. Looper, for Style 1900 K..... Looper Set Screw No. 73.	8
1911 L	Loop Retainer, for use with throat plate No. 1924 L.....	—
1917 K	Needle Bar, hardened and ground, for Style 1900 K..... Needle Bar Set Screws No. 88 A.	23
1920 J	Presser Foot, for Style 1900 K..... Presser Foot Set Screws No. 22570. Presser Foot Spring No. 6533. Presser Foot Spring Screw No. 605.	7
1920 K	Presser Foot, for Style 1900 K, with gauge attached to cloth plate slide..... Presser Foot Set Screws No. 88.	—
1922 D	Main Shaft, hardened and ground, for Style 1900 K.....	25
1924 J	Throat Plate, for Style 1900 K..... Throat Plate Screws No. 87. Throat Plate Loop Retainer No. 27 X. Throat Plate Loop Retainer Screw No. 87 U. Throat Plate Loop Retainer Adjusting Screw No. 1096.	3
1924 L	Throat Plate, for Style 1900 K, with gauge attached to cloth plate slide..... Throat Plate Screws No. 87.	—

LIST OF PARTS

Symbol to Order by	The figures in the last column refer only to the plates illustrating the parts and are not to be used in ordering.	Plate No.
1931	Edge Guide, for Style 1900 K, with gauge attached to cloth plate slide.....	—
	Edge Guide Thumbscrew No. 22756.	
1931 A	Edge Guide Swinging Arm, for Style 1900 K.....	—
	Edge Guide Swinging Arm Pivot Stud No. 22726.	
	Edge Guide Swinging Arm Pivot Stud Spring Washer No. 12957 E.	
1931 B	Edge Guide Swinging Arm Base.....	—
1931 C	Edge Guide, adjustable.....	—
	Edge Guide Thumbscrew No. 22756.	
1935	Feed Rocker, non-floating design, for Style 1900 K.....	28
1937	Feed Bar Prong and Sponge, for Style 1900 K.....	24
	Feed Bar Prong Screws No. 94.	
1939	Feed Crank Link, hardened, for Style 1900 K.....	15
	Feed Crank Link Shim, No. 1248.	
	Feed Crank Link Screw, $\frac{3}{8}\frac{3}{4}$ inch long, No. 22569.	
	Feed Crank Link Lock Nut No. 7947.	
	Feed Crank Link Screw, $\frac{1}{2}\frac{1}{2}$ inch long, No. 79, obsolete.	
1940	Feed Crank Stud Cap, for Style 1900 K.....	24
	Feed Crank Stud Cap Screws No. 77.	
1941	Feed Bar Shoe, for Style 1900 K.....	24
	Feed Bar Shoe Screw No. 94.	
‡ 1955 M	Needle Lever Connecting Rod Lower Bearing, splash feed oiling, for Style 1900 K.....	—
	Needle Lever Connecting Rod Lower Bearing Screws No. 22587.	
2305 P	Main Feed Dog, for Styles 2300 P, 2300 Q.....	6
2305 R	Main Feed Dog, for Style 2300 R.....	6
	Main Feed Dog Screw No. 90.	
2306	Feed Lift Eccentric, ground, for Styles 2300 P, 2300 Q, 2300 R.....	24
	Feed Lift Eccentric Screw No. 95.	
2315 A	Needle Lever, for styles in Class 2300.....	28
2320 R	Presser Foot, for Style 2300 R.....	7
	Presser Foot Clamp Screw No. 91.	
2324 P	Throat Plate, for Style 2300 P.....	2
2324 Q	Throat Plate, for Style 2300 Q.....	2
2324 R	Throat Plate, for Style 2300 R.....	2
	Throat Plate Screws No. 87.	
2326 A	Feed Dog, for Style 2300 M.....	5
	Feed Dog Screw No. 93 A.	
2326 P	Differential Feed Dog, for Styles 2300 P, 2300 Q.....	5
2326 R	Differential Feed Dog, for Style 2300 R.....	5
	Differential Feed Dog Screw No. 22585.	
2331	Feed Rocker, for Styles 2300 P, 2300 Q, 2300 R.....	27
	Feed Rocker Screws No. 88.	

‡ See page 7.

LIST OF PARTS

Symbol to Order by	The figures in the last column refer only to the plates illustrating the parts and are not to be used in ordering.	Plate No
2332	Feed Bar, for Styles 2300 P, 2300 Q, 2300 R..... Feed Bar Screws No. 88.	22
2333	Feed Bar Prong and Sponge for Styles 2300 P, 2300 Q, 2300 R..... Feed Bar Prong Screws No. 94.	24
2334	Differential Feed Bar Link, for Styles 2300 P, 2300 Q, 2300 R..... Differential Feed Bar Link Screw No. 97.	15
2335	Differential Feed Bar, for Styles 2300 P, 2300 Q, 2300 R....	20
2336	Differential Feed Bar Guide..... Differential Feed Bar Guide Screws No. 93 A.	15
2338	Main Shaft Sleeve, left, $1\frac{1}{4}$ inches long for Styles 2300 P, 2300 Q, 2300 R.....	16
2340	Trimmer Bracket Arm Connection, for styles in Class 2300 .. Trimmer Bracket Arm Connection Screws No. 94.	12
2341	Upper Toggle, $\frac{5}{8}$ inch blade, sides beveled equal, minimum width of seam $\frac{7}{16}$ inch, for styles in Class 2300.....	4
2343	Upper Toggle, for Styles 2300 M, 2300 R.....	4
2343 A	Upper Toggle, $\frac{3}{4}$ inch blade, two teeth, double cutting edges, minimum width of seam $\frac{1}{8}$ inch, for styles in Class 2300.....	4
2345	Upper Toggle, $\frac{3}{4}$ inch blade, beveled both sides, minimum width of seam $\frac{1}{8}$ inch.....	4
2349	Upper Toggle, $1\frac{1}{8}$ inch blade, flat surface in front of notch, minimum width of seam $\frac{1}{8}$ inch.....	4
2349 A	Upper Toggle, $1\frac{1}{8}$ inch blade, minimum width of seam $\frac{1}{8}$ inch.....	4
	Upper Toggle Screw No. T22.	
2355	Lower Toggle, $\frac{7}{8}$ inch blade, for styles in Class 2300..... Lower Toggle Screw No. T12.	4
2366 B	Trimmer Pitman Assembly, for Styles 2300 A, 2300 B, 2300 M, 2300 N; one each Nos. 2366 C, 2366 D and two No. 87 U.....	15
2366 C	Trimmer Pitman, front section, for assembly No. 2366 B....	—
2366 D	Trimmer Pitman, rear section, for assembly No. 2366 B..... Trimmer Pitman Screws No. 87 U.	—
2366 E	Trimmer Pitman Assembly, for Styles 2300 P, 2300 Q, 2300 R; one each Nos. 2366 F, 2366 G and two No. 87 U..	15
2366 F	Trimmer Pitman, front section, for assembly No. 2366 E....	—
2366 G	Trimmer Pitman, rear section, for assembly No. 2366 E.... Trimmer Pitman Screws No. 87 U.	—
2373	Rivet Pin, for trimmer bracket and stand assembly.....	—
2375 A	Toggle Grinder Assembly.....	30
2389 B	Looper Thread Pull-off Wire, for styles in Class 2300.....	13
2390	Looper Thread Pull-off Frame.....	13
2392	Frame Chain Knife, for Style 2300 N..... Frame Chain Knife Screw No. 25 CC.	4

LIST OF PARTS

Symbol to Order by	The figures in the last column refer only to the plates illustrating the parts and are not to be used in ordering.	Plate No.
2394	Trimmer Clamp Screw, for styles in Class 2300.....	10
2395	Trimmer Clamp Lever.....	20
	Trimmer Clamp Lever Screw No. 22572.	
2396	Trimmer Stand Regulating Rod, for styles in Class 2300....	23
2397	Trimmer Stand Adjustment Indicator.....	11
2397 A	Trimmer Stand Adjustment Indicator Lock Nut.....	11
2397 B	Trimmer Stand Adjustment Indicator Lock Nut Cover.....	11
‡2398	Trimmer Stand Adjustment Indicator Support.....	3
	Trimmer Stand Adjustment Indicator Support Screw No. 22517.	
2501 J	Cloth Plate, for Style 2600 H.....	29
	Cloth Plate Screws No. 80.	
2503 J	Gauge, for Style 2600 H.....	12
	Gauge Screw No. 25 S.	
2505 A	Feed Dog, ten teeth to inch, otherwise same as No. 22 D...	5
2505 B	Feed Dog, for Style 2600 G.....	5
	Feed Dog Screw No. 93.	
2515 A	Needle Lever, for Styles 1900 K, 2600 A, 2600 D, 2600 F, 2600 G, 2600 H.....	28
2524 B	Throat Plate, for Style 2600 G.....	2
2524 J	Throat Plate, for Style 2600 H.....	2
	Throat Plate Screws No. 87.	
2527 D	Presser Foot, for Style 2600 H.....	7
	Presser Foot Clamp Screw No. 91.	
2601	Cloth Plate, for Styles 2600 A, 2600 D.....	29
	Cloth Plate Screws No. 80.	
2603 D	Welt Gauge Assembly, for Style 2600 D.....	19
2605 A	Under Feed Dog, for Styles 2600 A, 2600 D.....	5
	Under Feed Dog Screw No. 93.	
2624 A	Throat Plate, for Styles 2600 A, 2600 D.....	2
	Throat Plate Screws No. 87.	
2650	Upper Feed Dog Lifter, for Styles 2600 A, 2600 D, 5800 C, 5800 H, 5800 J.....	20
	Upper Feed Dog Lifter Screw No. 98.	
4517	Needle Bar, hardened and ground, for Style 1200 A.....	23
	Needle Bar Set Screws No. 88.	
4937	Differential Feed Bar Link Stud, front, for Styles 2300 P, 2300 Q, 2300 R.....	10
5002 J	Cloth Plate Hinged Cover, for Styles 5800 C, 5800 H, 5800 J.....	21
5002 L	Cloth Plate Hinged Cover, for Styles 1200 AA.....	21
	Cloth Plate Hinged Cover Screws No. 25 CC.	
5005 H	Under Feed Dog, for Styles 5800 C, 5800 H.....	5
	Under Feed Dog Screw No. 93.	
5005 P	Upper Feed Dog, for Style 5800 C.....	6
	Upper Feed Dog Screw No. 87 U.	

‡ See page 7.

LIST OF PARTS

Symbol to Order by	The figures in the last column refer only to the plates illustrating the parts and are not to be used in ordering.	Plate No.
5045	Upper Feed Dog Holder Arm, for Styles 5800 C, 5800 H, 5800 J.....	6
	Upper Feed Dog Holder Arm Screw No. 93 A.	
5125	Feed Bar Needle Rear Guard, for Style 1200 A.....	11
	Feed Bar Needle Rear Guard Screw No. 94.	
5142	Feed Bar, for Styles 1200 A, 1700 H, 1900 K, 2600 J.....	25
	Feed Bar Screws No. 88.	
5143	Differential Feed Bar, for Styles 1200 AA, 5600 C.....	22
5144	Differential Feed Bar Link Stud Nut.....	11
5150	Main Feed Dog Holder, for Style 1200 AA.....	15
	Main Feed Dog Holder Screw No. 93.	
5156	Feed Rocker, non-floating design, for Styles 1200 AA, 5600 C.....	27
	Feed Rocker Screws No. 88.	
5157	Feed Rocker Arm, for use with feed rocker No. 5156.....	22
	Feed Rocker Arm Screws No. 22548.	
5449	Looper Connecting Rod, $6\frac{7}{8}$ inches long, for Styles 1200 C, 1200 G, 1200 O, 1200 Q, 1200 AA, 1200 AC, 1700 A, 1700 B, 1700 F, 1700 H, 2600 J, 5600 C.....	23
†5601 C	Cloth Plate Assembly, for Style 5600 C.....	29
	Cloth Plate Screws No. 80.	
5605 D	Main Feed Dog, for Styles 5600 D.....	5
	Main Feed Dog Screws No. 22593.	
5620 C	Presser Foot, for Style 5600 C.....	7
	Presser Foot Clamp Screw No. 91.	
5624 C	Throat Plate, for Style 5600 C.....	1
	Throat Plate Screws No. 87.	
5626	Differential Feed Dog, for Styles 1200 AA, 5600 C.....	5
	Differential Feed Dog Screw No. 22585.	
5650	Main Feed Dog Holder, for Style 5600 C.....	15
	Main Feed Dog Holder Screw No. 93.	
5723	Looper Thread Take-up, for Styles 1200 AC, 1200 AD, 1700 F, 1700 G, 1700 H.....	3
	Looper Thread Take-up Screw No. 89.	
†5801 C	Cloth Plate Assembly, for Styles 1200 AA, 5800 C, 5800 H, 5800 J.....	29
	Cloth Plate Screws No. 80.	
5805 X	Upper Feed Dog, 16 teeth to inch, for Style 5800 Z, to perform welt seaming operations on automobile work....	6
	Upper Feed Dog Screws No. 87 U.	
5807	Looper, with guard, for styles in Classes 5600, 5800; also Style 1200 AA.....	8
5813	Looper Rocker, hardened, for styles in Classes 5600, 5800; also Style 1200 AA.....	17
5820 C	Presser Foot, for Style 5800 C.....	8

† See page 7.

LIST OF PARTS

Symbol to Order by	The figures in the last column refer only to the plates illustrating the parts and are not to be used in ordering.	Plate No.
5820 J	Presser Foot, with groove, for Style 5800 Z, to perform welt seaming operations on automobile work..... Presser Foot Clamp Screw No. 91.	—
5824 C	Throat Plate, for Styles 5800 C, 5800 H.....	3
5824 J	Throat Plate, for Style 5800 J..... Throat Plate Screw No. 87.	2
5826	Under Feed Dog, for Style 5800 Z, to perform welt seaming operations on automobile work..... Under Feed Dog Screw No. 93.	5
5826 B	Upper Feed Dog, for Style 5800 H..... Upper Feed Dog Screws No. 87 U.	6
5826 C	Under Feed Dog, for Style 5800 J..... Under Feed Dog Screw No. 93.	5
5826 D	Upper Feed Dog, for Style 5800 J..... Upper Feed Dog Screws No. 87 U.	6
5827 A	Presser Foot, for Style 5800 H.....	8
5827 B	Presser Foot, for Style 5800 J..... Presser Foot Clamp Screw No. 91.	8
5828 A	Throat Plate, for Style 5800 Z, to perform welt seaming operations on automobile work..... Throat Plate Screws No. 87.	1
5842 A	Upper Feed Dog Holder, for styles in Class 5800..... Upper Feed Dog Holder Screws No. 93 A.	15
6042	Needle Lever Ball Clamp Bolt.....	10
6207 B	Looper, with guard, for Styles 1200 AC, 1700 F, 1700 H, 2600 J.....	8
6208 B	Looper, without guard, otherwise same as No. 6207 B..... Looper Set Screw No. 73	8
6402 F	Cloth Plate Slide, right, for Style 5600 C..... Cloth Plate Slide Thumbscrew No. 25 T.	21
6440	Cloth Plate Slide Stop, for Style 5600 C..... Cloth Plate Slide Stop Screws No. 88 A.	19
6502 P	Cloth Plate Slide, right, for Style 1900 K, using gauge assembly No. 1903 K..... Cloth Plate Slide Thumbscrew No. 25 T.	21
6533	Presser Foot Spring, for Style 1900 K.....	14
7421	Eccentric Pulley, throw .461 inch, for Styles 2600 A, 2600 D, 2600 F, 2600 G, 2600 H..... Eccentric Pulley Screws No. 22597.	18
7638 A	Looper Thread Deflecting Wire, for styles in Classes 1200, 1700, 2300, 2600, 5600..... Looper Thread Deflecting Wire Screw No. 93.	24
8645	Quilting Guide, right, adjustable, for Style 1200 AD.....	27
8646	Quilting Guide, left, adjustable..... Quilting Guide Screw No. 88.	27
8647	Quilting Guide Support..... Quilting Guide Support Screw No. 88.	27

LIST OF PARTS

Symbol to Order by	The figures in the last column refer only to the plates illustrating the parts and are not to be used in ordering.	Plate No.
8648	Quilting Guide Assembly, for Style 1200 AD; one each Nos. 8645, 8646, 8647 and three No. 88.....	—
9205 E	Feed Dog, for Style 1200 AC..... Feed Dog Screw No. 93.	5
9224 E	Throat Plate, for Style 1200 AC..... Throat Plate Screws No. 87.	3
9255	Washer, for swing gauge assemblies on Style 1900 K.....	14
9525	Feed Bar Needle Rear Guard, hardened, for Style 1700 H.... Feed Bar Needle Rear Guard Screw No. 94.	11
9725	Throat Plate Needle Rear Guard, hardened, for Style 1700 G.. Throat Plate Needle Rear Guard Screw No. 87.	11
9932	Feed Bar Shoe, hardened and ground, for styles in Classes 1700, 2300, 2600, 5800; also for Styles 1200 A, 1200 C, 1200 G, 1200 O, 1200 Q, 1200 AC, 1200 AD.....	24
	Feed Bar Shoe Screw No. 94.	
10314	Looper Eccentric, ground, for Styles 1200 AD, 1700 G..... Looper Eccentric Screw No. 96.	24
11638 M	Toggle Grinder Turn Table Pivot Stud Nut.....	11
12821	Eccentric Pulley, throw .701 inch, for Style 1900 K..... Eccentric Pulley Screws No. 22597.	18
12873	Renewable Bearing, for needle bar, of styles in Classes 1700, 2300, 2600, 5600, 5800; also Styles 1200 C, 1200 G, 1200 O, 1200 Q, 1200 AA, 1200 AC, 1200 AD, 1900 K.....	16
12873 B	Renewable Bearing, for needle bar, in Style 1200 A..... Renewable Bearing Clamp Screw No. 22569.	16
12957 E	Spring Washer, for swing gauge assemblies on Style 1900 K....	14
12964 C	Needle Lever Link Pin Ball.....	12
12987 A	Looper Rocker Cone Adjusting Nut.....	11
12993 A	Stop Screw, for knee lifter interlocking arm.....	9
14544	Feed Bar Shaft, for differential feed machines.....	14
14649	Feed Rocker Shaft Collar, for Styles 2300 P, 2300 Q, 2300 R.. Feed Rocker Shaft Collar Screws No. 88.	24
15063	Presser Bar Connection, for Style 1900 K..... Presser Bar Connection Screws No. 88.	15
15430 C	Needle Lever Connecting Rod Tube Nut, left thread.....	11
15430 D	Needle Lever Connecting Rod Tube Nut, right thread; also for No. 21693 J.....	11
15430 L	Needle Lever Connecting Rod Tube Felt.....	17
†15430 M	Needle Lever Connecting Rod Lower Bearing, wick feed oil- ing, for styles in Classes 1200, 1700, 2300, 2600, 5600, 5800. Needle Lever Connecting Rod Lower Bearing Screws No. 22587.	17
15437 A	Needle Bar Connection and Thread Nipper Assembly, for use with .200 inch needle bars.....	13
15438 B	Needle Bar Connection Thread Nipper Disc, hardened and lapped.....	13
15438 C	Needle Bar Connection Thread Nipper Spring.....	14

† See page 7.

LIST OF PARTS

Symbol to Order by	The figures in the last column refer only to the plates illustrating the parts and are not to be used in ordering.	Plate No.
15438 D	Needle Bar Connection Thread Nipper Stud	10
15438 H	Needle Bar Connection	24
15438 J	Needle Bar Connection Thread Nipper Guide	24
15446 C	Differential Feed Bar Link Stud, rear	10
15446 D	Differential Feed Bar Link, for Styles 1200 AA, 5600 C	15
	Differential Feed Bar Link Screw No. 22743.	
15447 E	Feed Bar, for Styles 1200 AA, 5600 C	22
	Feed Bar Screws No. 88.	
15447 F	Feed Bar Shoe, hardened and ground, for Styles 1200 AA, 5600 C	12
	Feed Bar Shoe Screw No. 93.	
15447 G	Feed Bar Prong and Sponge for Styles 1200 AA, 5600 C	24
	Feed Bar Prong Screws No. 94.	
15447 K	Differential Feed Bar Guide Plate Holder, for Styles 1200 AA, 5600 C	15
	Differential Feed Bar Guide Plate Holder Screw, front, No. 93.	
	Differential Feed Bar Guide Plate Holder Screw, rear, No. 93 A.	
15447 L	Differential Feed Bar Guide Plate, adjustable	15
	Differential Feed Bar Guide Plate Screws No. 90.	
15465 F	Looper Rocker Cone, hardened and ground	16
	Looper Rocker Cone Set Screws No. 88.	
	Looper Rocker Cone Adjusting Nut No. 12987 A.	
15480 C	Spring, for presser foot, on Style 2300 R	14
	Spring Screw No. 57 WD.	
15745 B	Looper Rocker Cone Stud, hardened and ground, $\frac{5}{16}$ inch diameter	10
15839 A	Differential Feed Bar Link Screw Pin, for Styles 2300 P, 2300 Q, 2300-R	10
17158	Looper Thread Take-up Eyelet, for styles in Class 5800	24
	Looper Thread Take-up Eyelet Adjusting Screw No. 97.	
21104 A	Thread Stand Base; also for binding holder of Style 2600 H	28
	Thread Stand Base Screw No. 22509.	
21104 B-2	Thread Stand Rod, 2 inches long, for Style 1900 K	25
21104 B-11	Thread Stand Rod, 11 inches long	25
21104 B-20	Binding Holder Rod, 20 inches long, for Style 2600 H	25
	Binding Holder Rod Set Screw No. 22509.	
21104 C	Thread Stand Rod Connection, for Style 1900 K	24
	Thread Stand Rod Connection Screws No. 22509.	
21104 D	Thread Stand Seat, for Style 1900 K	28
	Thread Stand Seat Set Screw No. 69 FD.	
21104 E	Thread Stand Seat Connection, tiltable, for Style 1900 K	24
21104 F	Thread Stand Seat Pad, felt	28
21104 G	Spool Pin, $4\frac{5}{8}$ inches long, for Style 1900 K	28
21104 H	Spool Pin Nut	11

LIST OF PARTS

Symbol to Order by	The figures in the last column refer only to the plates illustrating the parts and are not to be used in ordering.	Plate No.
21104 K	Thread Stand Wire, 16 inches long, for Style 1900 K..... Thread Stand Wire Set Screw, square head, 24 threads to inch, No. 22632 F-24. Thread Stand Wire Set Screw, headless, 24 threads to inch, No. 22813, obsolete.	28
21105 J	Thread Stand Wire Eyelet.....	14
21113 A	Thread Stand Wire Extension, 6 inches long, for styles in Classes 1200, 2300, 5600, 5800.....	23
	Thread Stand Wire Extension Set Screw, square head, 24 threads to inch, No. 22632 F-24. Thread Stand Wire Extension Set Screw, headless, No. 22813, obsolete.	
21113 B	Thread Stand Wire Coupling..... Thread Stand Wire Coupling Screws No. 88.	16
21130 A-2	Thread Stand Seat, for styles in Classes 1200, 1700, 2300, 2600, 5600, 5800.....	28
21145	Thread Stand Cone, wood, for styles in Classes 1200, 1700, 2300, 2600, 5600, 5800.....	22
21150	Binding Holder Assembly, for Style 2600 H; one each Nos. 25 S, 88, 94, 430, 431 A, 432, 433, 434, 21161 C, 21161 D, 21163, 21164 and two each Nos. 98, 21157.....	29
21157	Binding Holder Disc, 8 inches diameter.....	29
21161 C	Binding Holder Frame..... Binding Holder Frame Set Screws No. 98.	28
21161 D	Binding Guide..... Binding Guide Set Screw No. 88.	28
21163	Binding Holder Rod, $4\frac{5}{8}$ inches long..... Binding Holder Rod Set Screw No. 25 S.	23
21164	Binding Holder Post..... Binding Holder Post Set Screw No. 22508.	23
21168	Binding Holder Assembly, for Style 5600 C; one each Nos. 20, 430, 431 A, 432, 433, 434, 21168 A, 21168 B and two each Nos. 18, 427.....	29
21168 A	Binding Holder Axle Base..... Binding Holder Axle Base Nut No. 18.	—
21168 B	Binding Holder Stand.....	—
21169 E	Split Tubing and Button Stay Holder Disc, 8 inches diam- eter, for Styles 5800 H, 5800 J.....	29
21169 F	Split Tubing and Button Stay Holder Base.....	28
21173 A	Binding Holder Auxiliary Support Connection, for Style 2600 H..... Binding Holder Auxiliary Support Connection Screw No. 22508.	28
21173 B	Binding Holder Post Socket..... Binding Holder Post Socket Screw No. 22508.	28
21178 A	Collarette Holder Disc, 11 inches diameter, $\frac{9}{32}$ inch hole.....	29
21185	Collarette Folder Tension Nut, for Styles 1200 AA, 5800 C...	11

LIST OF PARTS

Symbol to Order by	The figures in the last column refer only to the plates illustrating the parts and are not to be used in ordering.	Plate No.
21185 C	Collarette Folder Tension Post.....	—
21192	Collarette Holder Assembly, for Styles 1200 AA, 5800 C.....	29
21192 A	Collarette Holder Disc, 8 inches diameter, including pin....	—
	Collarette Holder Disc, 11 inches diameter, $\frac{9}{32}$ inch hole No. 21178 A.	—
21192 F	Collarette Holder Base.....	—
	Collarette Holder Base Screw No. 22813.	—
	Collarette Holder Base Screw No. 96, obsolete.	—
21192 G	Collarette Holder Pin Tension.....	—
21201	Screw Driver, round steel, diameter $\frac{5}{32}$ inch, length overall $7\frac{5}{8}$ inches.....	26
21202	Screw Driver, round steel, diameter $\frac{7}{32}$ inch, length overall 10 inches.....	26
21203	Screw Driver, round steel, diameter $\frac{7}{32}$ inch, length overall 13 inches.....	26
21204	Screw Driver, round steel, diameter $\frac{1}{4}$ inch, length overall 15 inches.....	26
21205	Screw Driver, octagon steel, diameter $\frac{5}{16}$ inch, length overall $14\frac{1}{2}$ inches.....	26
21206	Screw Driver Wrench.....	26
21207	Screw Driver, round steel, diameter $\frac{5}{16}$ inch, length overall $2\frac{1}{2}$ inches.....	26
21208	Screw Driver Set, three blades.....	26
21210	Looper Collar, .040 inch thick.....	14
21210 A	Looper Collar, .020 inch thick.....	—
21211	Looper Collar, .054 inch thick.....	14
21225- $\frac{1}{6}$ $\frac{3}{4}$	Looper Adjusting Gauge, $\frac{1}{8}$ $\frac{3}{4}$ inch measurement.....	14
21225- $\frac{7}{32}$	Looper Adjusting Gauge, $\frac{7}{32}$ inch measurement.....	14
21225- $\frac{1}{4}$	Looper Adjusting Gauge, $\frac{1}{4}$ inch measurement.....	14
21225- $\frac{9}{32}$	Looper Adjusting Gauge, $\frac{9}{32}$ inch measurement.....	14
21225 A	Looper Gauge, universal adjustment.....	14
21261	Leather Belt, flat, 1 inch wide, 63 inches long, including malleable iron belt fastener No. 21350.....	—
21262	Leather Belt, round, $\frac{9}{32}$ inch diameter, 44 inches long, includ- ing wire belt hook No. 21351.....	—
21350	Malleable Iron Belt Fastener, for 1 inch flat belt.....	14
21351	Wire Belt Hook, for $\frac{9}{32}$ inch round belt.....	14
21355	Chair Leg Extension, 4 inches long.....	18
21355 A	Chair Leg Extension, 6 inches long.....	18
21355 B	Chair Leg Extension, 3 inches long.....	18
<input type="checkbox"/> 21368	Washer, $\frac{1}{4}$ inch, for flat head stove bolts.....	—
21371 B	Table Top, 48 inches long, $16\frac{1}{8}$ inches wide, $1\frac{3}{4}$ inches thick...	—

See page 7.

LIST OF PARTS

Symbol to Order by	The figures in the last column refer only to the plates illustrating the parts and are not to be used in ordering.	Plate No.
21375 A	Pulley Guard	29
21376 C	Tray, or work support, wood, 1½ inches thick, for use with table top No. 21371 BB.	28
21376 D	Tray, or work support, wood, 3⅛ inches high, including clamp- ing bolt.	28
21384 A	Leather Plug, for cloth plate screw holes	—
21388	Wrench, hardened, for ⅜ inch hexagon nuts.	20
21388 B	Wrench, hardened, for ½ inch hexagon nuts.	20
21390 A	Needle Thread Intermittent Nipper Spring, front.	24
21390 B	Needle Thread Intermittent Nipper Spring, rear.	24
21390 E	Needle Thread Intermittent Nipper Spring Screw No. 22564. Needle Thread Intermittent Nipper Spring Operating Block Screw No. 90.	24
21390 AS	Needle Thread Intermittent Nipper Spring Support. Needle Thread Intermittent Nipper Spring Support Screws No. 87.	—
21390 AT	Needle Thread Intermittent Nipper Dowel Pin.	—
21390 AW	Needle Thread Intermittent Nipper Assembly, for Styles 1900 K, 2600 A, 2600 D, 2600 F, 2600 G, 2600 H; one each Nos. 90, 21390 A, 21390 B, 21390 E, 21390 AS, 21390 AT, 21392 B, 22564, 22585 and two No. 87	24
21392 B	Needle Thread Intermittent Nipper Operating Block Sup- port. Needle Thread Intermittent Nipper Operating Block Support Screw No. 22585.	—
21394	Small Utility Grinder, including emery wheel, 5 inches diam- eter, ¼ inch face, recommended speed 3000 revolutions per minute.	—
21394 G	Emery Wheel, 5 inches diameter, ¼ inch face, ⅜ inch hole.	—
21394 H	Emery Wheel, 5 inches diameter, ½ inch face, ⅜ inch hole.	—
21394 K	Grinder, including emery wheel, 5 inches diameter, ½ inch face, recommended speed 3000 revolutions per minute.	—
21602	Needle Thread Pull-off Post, for Styles 2600 A, 2600 D, 2600 F, 2600 G. Needle Thread Pull-off Post Screw No. 94.	24

LIST OF PARTS

Symbol to Order by	The figures in the last column refer only to the plates illustrating the parts and are not to be used in ordering.	Plate No.
21605	Needle Thread Pull-off Rolling Sleeve.....	20
21606	Needle Thread Pull-off Rolling Sleeve Axle.....	20
21607	Needle Thread Pull-off Clamp Sleeve.....	20
	Needle Thread Pull-off Clamp Sleeve Set Screw No. 87 U....	
21608	Needle Thread Take-up Wire, for Styles 2600 A, 2600 D, 2600 F, 2600 G.....	24
	Needle Thread Take-up Wire Set Screw No. 87 U.	
21610 A	Needle Bar Rolling Thread Guide, for Styles 2600 A, 2600 D, 2600 F, 2600 G.....	13
	Needle Bar Rolling Thread Guide Screw No. 22768.	
21624	Thread Controller Rolling Thread Guide, for Styles 2600 A, 2600 D, 2600 F, 2600 G.....	13
	Thread Controller Rolling Thread Guide Screw No. 138.	
21632	Needle Lever Rolling Thread Guide, for Styles 2600 A, 2600 D, 2600 F, 2600 G.....	13
	Needle Lever Rolling Thread Guide Screw No. 98 A.	
21685	Knee Lifter Plate.....	—
	Knee Lifter Plate Set Screw No. 69 FD.	
21692	Knee Lifter Chain, 18 inches long.....	27
21693 A	Knee Lift Assembly, excluding chain; one each Nos. 15430 D, 21685, 21693 B, 21693 C, 21693 D, 21693 F, 21693 G, 21693 H, 21693 J, 21693 K, 21693 T, 22622, two each Nos. 34, 650-10, 12993 A, three Nos. 69 FD and four No. 28577.	29
21693 B	Knee Lifter Shaft.....	—
21693 C	Knee Lifter Frame.....	—
21693 D	Knee Lifter Shaft Hanger, rear, lower section.....	—
	Knee Lifter Shaft Hanger Bolt No. 650-10.	
	Knee Lifter Shaft Hanger Compensating Washer No. 28577.	
21693 F	Knee Lifter Interlocking Forked Arm.....	—
	Knee Lifter Interlocking Forked Arm Set Screw No. 69 FD.	
21693 G	Knee Lifter Interlocking Arm, with engaging pin.....	—
	Knee Lifter Interlocking Arm Set Screw No. 22622.	
	Knee Lifter Interlocking Arm Stop Screw No. 12993 A.	
	Knee Lifter Interlocking Arm Stop Screw Lock Nut No. 34.	
21693 H	Knee Lifter Interlocking Arm Pivot Pin, $1\frac{5}{8}$ inches long....	—
21693 J	Knee Lifter Plate Rod.....	—
	Knee Lifter Plate Rod Lock Nut No. 15430 D.	
21693 K	Knee Lifter Chain Arm.....	—
	Knee Lifter Chain Arm Set Screw No. 69 FD.	
	Knee Lifter Chain Arm Stop Screw No. 12993 A.	
	Knee Lifter Chain Arm Stop Screw Lock Nut No. 34.	
21693 T	Knee Lifter Shaft Hanger, rear, upper section.....	—
<input type="checkbox"/> 22508	Set Screw, square head, cup point, $\frac{1}{4}$ inch diameter, 20 threads to inch, $\frac{1}{2}$ inch long, for binding holder auxiliary support connection; also for Nos. 21164, 21173 B.....	9

See page 7.

LIST OF PARTS

Symbol to Order by	The figures in the last column refer only to the plates illustrating the parts and are not to be used in ordering.	Plate No.
<input type="checkbox"/> 22509	Set Screw, square head, cup point, $\frac{5}{16}$ inch diameter, 18 threads to inch, $\frac{1}{2}$ inch long, for thread stand base; also for Nos. 21104 B-11, 21104 B-20, 21104 C.....	9
22514	Screw, $\frac{7}{16}$ inch long, for cloth plate attachments.....	9
22517	Screw, for trimmer stand adjustment index support.....	10
22519	Set Screw, hexagon head, for rolling presser foot support..	9
22521	Screw, plus size, for cloth plates, tap No. V118.....	9
22524	Screw, for cast-off wires.....	9
22526	Screw, plus size, diameter $\frac{3}{16}$ inch, for throat plates, tap No. V109.....	9
22539	Plug Screw, $\frac{5}{32}$ inch long, for oiling system.....	10
22548	Screw, for trimmer pitman bracket, also for Nos. 1592 C, 1593 E, 5157.....	9
22560	Screw, for needle lever link pin spring; also for No. G52....	9
22564	Screw, for needle thread intermittent nipper springs.....	9
22565	Set Screw, headless, for loopers.....	9
22569	Screw, $\frac{1}{8}$ inch long, for feed crank link; also for No. 12873 ..	9
22570	Set Screw, for upper toggle adjusting wedge, on styles in Class 2300.....	9
22572	Screw, for trimmer clamp lever, on styles in Class 2300.....	9
22575	Stop Screw, headless, for roller support swinging arm on Styles 2600 G, 2600 J; also for No. G34.....	9
22584	Set Screw, for upper roller support swinging arm bracket on Styles 2600 G, 2600 J.....	9
22585	Screw, for differential feed dogs; also for No. 21392 B.....	9
22586	Plug Screw, for needle lever stud.....	9
22586 A	Screw, for needle lever connecting rod upper bearing valve spring.....	9
22587	Screw, for needle lever connecting rod upper bearing; also for Nos. 1230 G, 1955 M, 15430 M.....	10
22593	Screw, for main feed dog, in Style 1200 AA, 5600 C.....	9
22594	Screw, for English Binders.....	10
22596	Screw, for looper thread take-up eyelet stand; also for No. 1859.....	9
22597	Screw, for eccentric pulleys.....	9
22622	Set Screw, for knee lifter interlocking arm.....	9
<input type="checkbox"/> 22632F-24	Screw, square head, cup point, $\frac{3}{16}$ inch diameter, $\frac{3}{8}$ inch long, 24 threads to inch, for thread stand wire; also for No. 21113 A.....	9
22726	Pivot Stud, for swing gauge assemblies on Style 1900 K.....	10
22743	Lock Screw, headless, for ball bearing rolling presser foot axle, on Styles 2600 G, 2600 J; also for No. 15446 D.....	9
22756	Thumbscrew, for swing gauge edge guides on Style 1900 K....	11
22768	Screw, for needle bar thread guides on styles in Classes 1700, 2300, 2600, 5600, 5800; also Styles 1200 C, 1200 G, 1200 O, 1200 Q, 1200 AA, 1200 AC, 1200 AD, 1900 K.....	9
22813	Screw, headless, for lifter treadle pin; also for No. 21192 F....	9

See page 7.

LIST OF PARTS

Symbol to Order by	The figures in the last column refer only to the plates illustrating the parts and are not to be used in ordering.	Plate No.
22818	Axle Screw, button head, for ball bearing rolling presser foot, on Styles 2600 G, 2600 J	9
23215 AE	English Binder, adjustable, for Style 5600 C- $\frac{5}{8}$, uses strip $\frac{3}{8}$ to $\frac{5}{8}$ inch wide	19
23215 AP	English Binder, adjustable, for Style 5600 C- $\frac{3}{4}$, uses strip $\frac{3}{4}$ to $\frac{1\frac{5}{8}}$ inch wide	19
	English Binder Screws No. 22594.	
23223 B	Binding Guide Assembly, adjustable from $\frac{3}{8}$ to $\frac{5}{8}$ inch, for Style 5600 C- $\frac{5}{8}$	19
23223 C	Binding Guide Assembly, adjustable, from $\frac{3}{4}$ to $\frac{1\frac{5}{8}}$ inch, for Style 5600 C- $\frac{3}{4}$	19
	Binding Guide Screws No. 25 C.	
23223 K	Binding Guide Adjustment, lower	—
23223 L	Binding Guide Adjustment, upper	—
	Binding Guide Adjustment Screws No. 187 A.	
23285 A- $\frac{1}{2}$	Collarette Folder Assembly, $\frac{1}{2}$ inch finished width, for Style 5800 C- $\frac{1}{2}$	19
23285 A- $\frac{5}{8}$	Collarette Folder Assembly, $\frac{5}{8}$ inch finished width, for Style 1200 AA- $\frac{5}{8}$	—
23285 A- $\frac{3}{4}$	Collarette Folder Assembly, $\frac{3}{4}$ inch finished width, for Style 1200 AA- $\frac{5}{8}$	—
	Collarette Folder Tension Post No. 21185 C. Collarette Folder Tension Spring No. 1349. Collarette Folder Tension Nuts No. 21185.	
23289 $\frac{1}{2}$	Folder, $\frac{1}{2}$ inch finished width, for button stay on Style 5800 H- $\frac{1}{2}$	27
23289 $\frac{5}{8}$	Folder, $\frac{5}{8}$ inch finished width	—
23289 $\frac{3}{4}$	Folder, $\frac{3}{4}$ inch finished width	—
	Folder Screws No. 25 C.	
23387 $\frac{7}{16}$	Hemmer, $\frac{7}{16}$ inch hem, $\frac{1}{16}$ inch capacity, for Style 1200 AC- $\frac{7}{16}$	27
	Hemmer Screws No. 25 C.	
23406 G- $\frac{1}{2}$	Folder, $\frac{1}{2}$ inch finished width, for Style 5800 J- $\frac{1}{2}$	27
	Folder Screws No. 25 C.	
<input type="checkbox"/> 28577	Knee Lifter Shaft Hanger Compensating Washer, $\frac{1}{4}$ inch	—
28606- $\frac{1}{2}$	Powdered Oil Stone, $\frac{1}{2}$ lb. package	—
28606-1	Powdered Oil Stone, 1 lb. package	—
29053 B	Eccentric Pulley Assembly, for Styles 1200 AC, 1700 F; one each Nos. 59 V, 15430 M lapped together	—
29055 C	Eccentric Pulley Assembly, for Style 1900 K; one each Nos. 59 X, 1230 G, lapped together; also two No. 41046 G	—
29066 B	Needle Lever Connecting Rod Upper Bearing Assembly; one each Nos. 1230 A, 156 lapped together; also 1230 B, 1230 D, 22586 A	15
29076 E	Eccentric Pulley Assembly, for Style 1900 K; one each Nos. 12821, 1955 M lapped together; also two No. 41046 G	—
29083 B	Eccentric Pulley Assembly, for Styles 1200 AD, 1700 G; one each Nos. 1721, 15430 M lapped together	—

See page 7.

LIST OF PARTS

Symbol to Order by	The figures in the last column refer only to the plates illustrating the parts and are not to be used in ordering.	Plate No.
29086 E	Eccentric Pulley Assembly, for styles in Classes 2300, 5600, 5800; also Styles 1200 A, 1200 C, 1200 G, 1200 O, 1200 Q, 1200 AA, 1700 A, 1700 B, 1700 H, 2600 J; one each Nos. 1221, 1230 G lapped together; also two No. 41046 G.	—
29087 E	Eccentric Pulley Assembly, for Styles 2600 A, 2600 D, 2600 F, 2600 G, 2600 H; one each Nos. 7421, 1230 G lapped together; also two No. 41046 G.	—
29150 L	Looper Rocker Assembly, $\frac{5}{16}$ inch diameter stud, for Style 1900 K; one each Nos. 29, 15465 F, 15745 B lapped together; also Nos. 36 L, 12987 A and two No. 88.	—
29153 L	Looper Rocker Assembly, $\frac{5}{16}$ inch diameter stud, for Styles 1200 AC, 1200 AD, 1700 F, 1700 G, 2600 A, 2600 D, 2600 F, 2600 G, 2600 H; one each Nos. 29 V, 15465 F, 15745 B lapped together; also Nos. 36 L, 12987 A and two No. 88.	—
29158 L	Looper Rocker Assembly, $\frac{5}{16}$ inch diameter stud, for Styles 1200 A, 1200 C, 1200 G, 1200 O, 1200 Q, 1700 A, 1700 B, 1700 H, 2600 J; one each Nos. 213, 15465 F, 15745 B lapped together; also Nos. 36 L, 12987 A and two No. 88.	—
29171 A	Looper Rocker Assembly, $\frac{5}{16}$ inch diameter stud, for styles in Classes 5600, 5800; also Style 1200 AA; one each Nos. 5813, 15465 F, 15745 B lapped together; also No. 12987 A and two No. 88.	—
29185 L	Looper Rocker Assembly, $\frac{5}{16}$ inch diameter stud, or styles in Class 2300; one each Nos. 181, 15465 F, 15745 B lapped together; also Nos. 36 L, 12987 A and two No. 88.	—
29300 B	Needle Lever Assembly, for styles in Classes 5600, 5800; also Styles 1200 A, 1200 C, 1200 G, 1200 O, 1200 Q, 1200 AA, 1200 AC, 1700 A, 1700 B, 1700 F, 1700 H, 2600 J; one each Nos. 1215 A, 1275 A lapped together; also No. 47.	—
29311 B	Needle Lever Assembly, for styles in Class 2300; one each Nos. 2315 A, 1275 A lapped together; also No. 47.	—
29327 A	Needle Lever Assembly, for Styles 1200 AD, 1700 G; one each Nos. 1715 A, 1275 A lapped together; also No. 47.	—
29329	Needle Lever Assembly, for Styles 1900 K, 2600 A, 2600 D, 2600 F, 2600 G, 2600 H; one each Nos. 2515 A, 1275 A lapped together; also No. 47.	—
29402	Lifter Treadle Assembly; one each Nos. 422, 423, 424, 22813	27
29436	Trimmer Bracket Stand Adjusting Nut Assembly, for styles in Class 2300; one each Nos. 2397, 2398 lapped together. .	—
29439	Trimmer Bracket and Stand Assembly, for styles in Class 2300; one each Nos. 2372, T8 and two No. 2373.	—
30036	Pivot Screw, for cloth plate extension.	10
30185 A	Toggle Grinder Spindle Renewable Bearing	24
	Toggle Grinder Spindle Renewable Bearing Clamp Screw No. G13.	
40146 G	Spring Valve Oiler, for needle lever connecting rod lower bearing No. 1230 G.	16

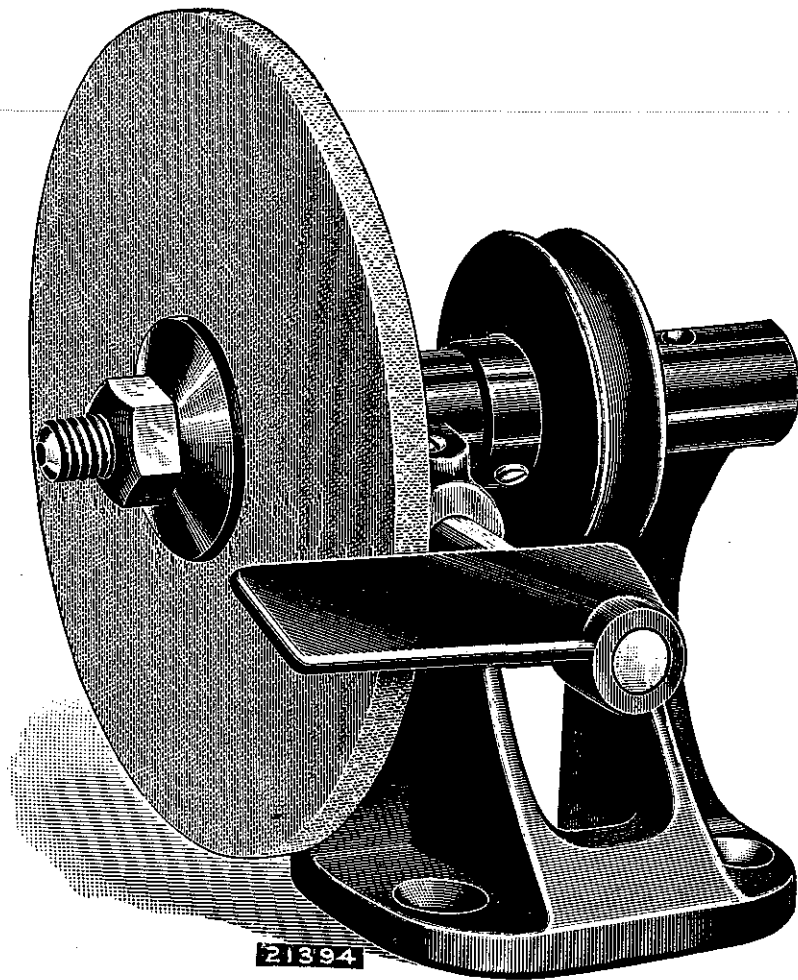

Utility Grinder

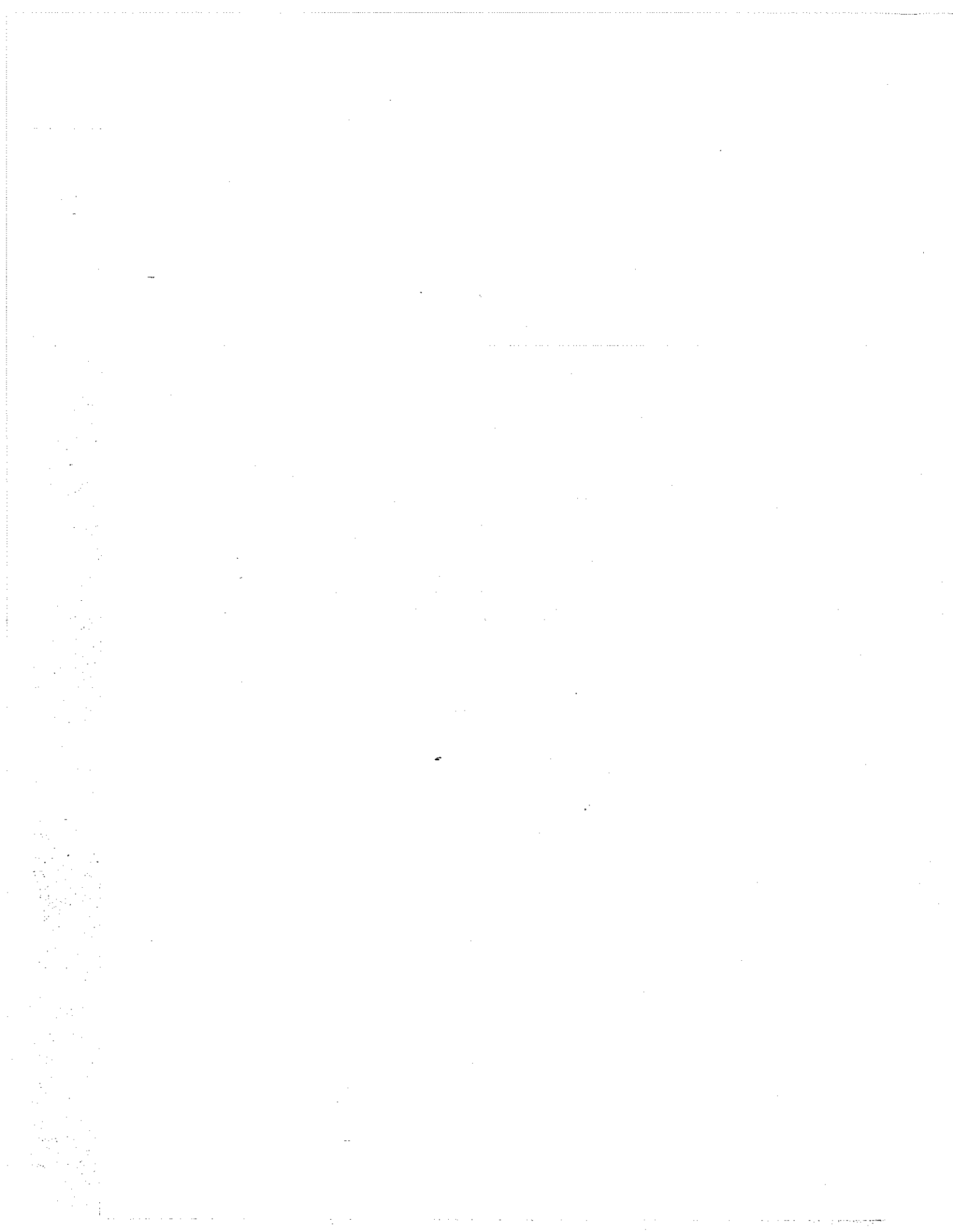

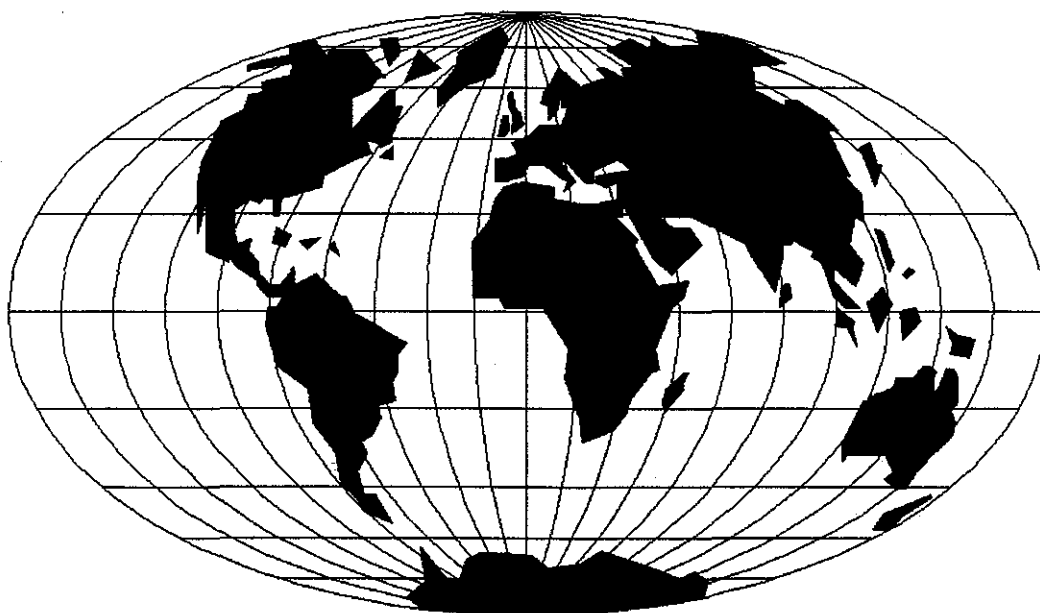

WORLDWIDE SALES AND SERVICE

Union Special Corporation maintains sales and service facilities throughout the world. These offices will aid you in the selection of the right sewing equipment for your particular operation. Union Special Corporation representatives and service technicians are factory trained and are able to serve your needs promptly and efficiently. Whatever your location, there is a qualified representative to serve you.

Corporate Office: One Union Special Plaza
Huntley, IL 60142
Phone: 847•669•5101
Fax: 847•669•1096

European Distribution Center: Union Special GmbH
Raiffeisenstrasse 3
D-71696 Möglingen, Germany
Tel: 49•07141•247•0
Fax: 49•7141•247•100

Brussels, Belgium
Charlotte, N.C.
El Paso, TX
Hong Kong, China
Huntley, IL
Leicester, England
Lille, France
Miami, FL
Milan, Italy
Möglingen, Germany
Montreal, Quebec
Osaka, Japan
Santa Fe Springs, CA

Other Representatives throughout
all parts of the world.



Union Special
INDUSTRIAL SEWING EQUIPMENT