

DIRT DEMON AUTOMATIC POOL CLEANER



*Congratulations on purchasing a
Dirt Demon Automatic Pool Cleaner.
You have made an excellent choice.*

MODEL DD 555

DD 555 DIRT DEMON INGROUND AUTOMATIC POOL CLEANER – PARTS

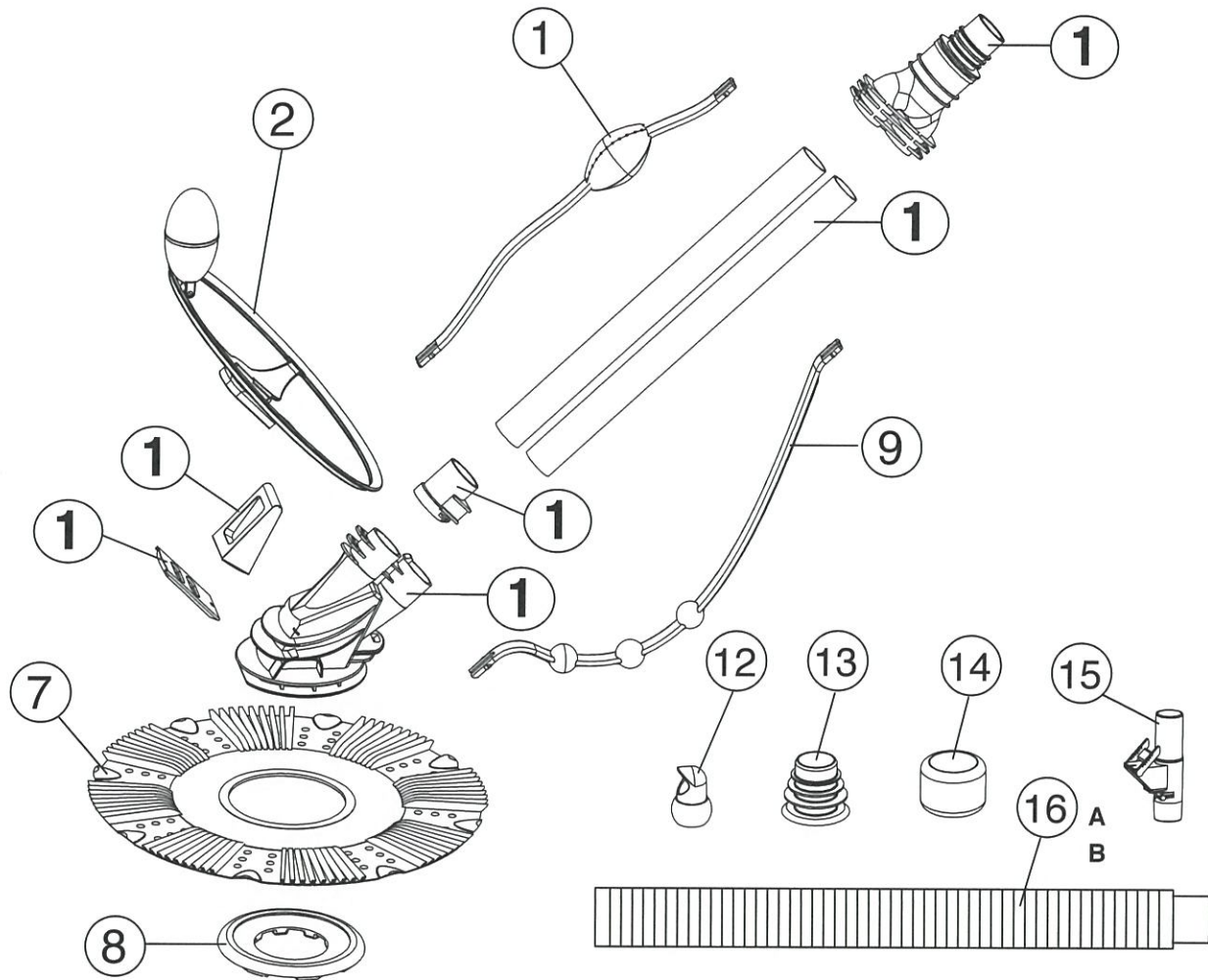

PART #	MODEL #	DESCRIPTION	QTY
1	DD 555AA	DD 555 Body	1
2	DD 102	Dive Float	1
7	DD 108	Seal Pleated	1
8	DD S2501	Foot Pad	1
9	DD 107	Bumper Strap	1
12	DD EYEBALL	Eyeball Diverter	1
13	DD CONE	Cone	1
14	DD WEIGHTS	Hose Weights	1
15	DD 105	Regulator Valve	1
16A	BS 64300BLK	Hose Bulk	9
16B	BS 64300FF	Hose Bulk Female	1

STEP 1 ATTACH THE SEAL

To install the seal locate the word "UP". Face it up towards the body of the cleaner. Gently stretch the seal over the foot pad of the cleaner until it sets itself into the groove as illustrated in figure 2. Once in place the seal should rotate and move freely.

NOTE

The seal is not reversible. It must be installed with the flat side facing down towards the pool liner and the pleated side facing upwards towards the cleaner.

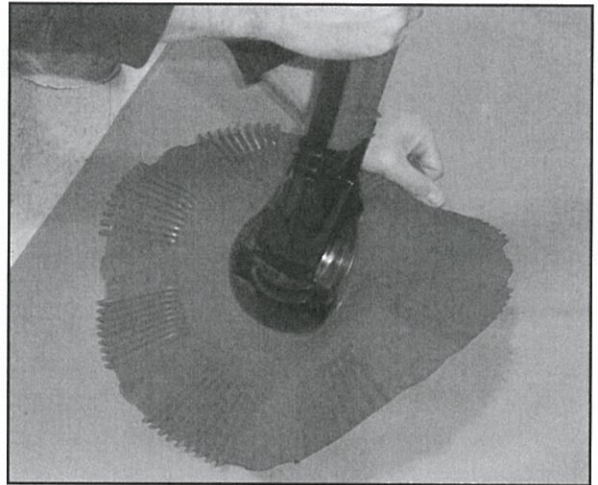

Figure 2

STEP 2 ATTACH THE DIVE FLOAT RESTRICTOR

The dive float restrictor is attached by sliding it over the cleaner's body as shown in figure 3. It is fastened by sliding it over the "U" shaped locking clip on the body of the cleaner. Make sure the locking tabs on both sides snap securely into place.

NOTE

The dive float restrictor should be installed with the float facing up.



Figure 3

STEP 3 ATTACH THE ROLLER BUMPER STRAP

Insert the bottom end of the strap into the slots provided on the top and bottom of the main body. Make sure that both ends snap in securely.

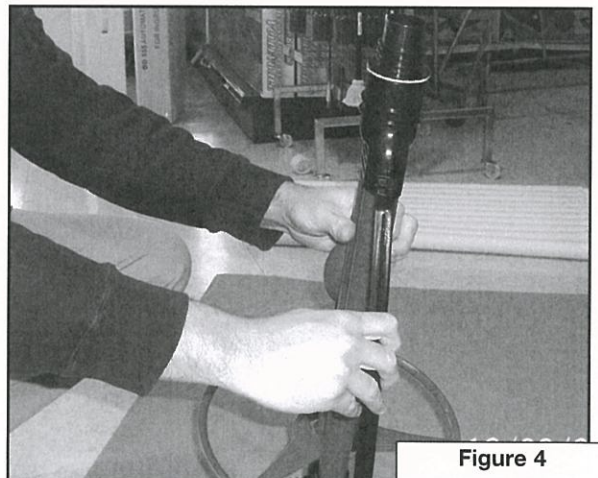

Figure 4

STEP 4 ASSEMBLE THE HOSE

Your cleaner hose comes in 3' sections which must be connected together. The hoses are connected by inserting the male cuff of one section of hose into the female cuff of another. Twist the sections of hose together until you establish a snug fit (See figure 5). You will need to assemble enough sections of hose to reach from where the cleaner connects to your skimmer to the opposite end of the pool, plus one section. For example, if you have a 21' round pool, you will need to connect 8 sections of hose for a total of 24' of hose.

NOTE

One of the hose sections has 2 female ends. This section should be fitted last and will attach to the pool's vacuum connection. Save extra sections of hose for replacements.

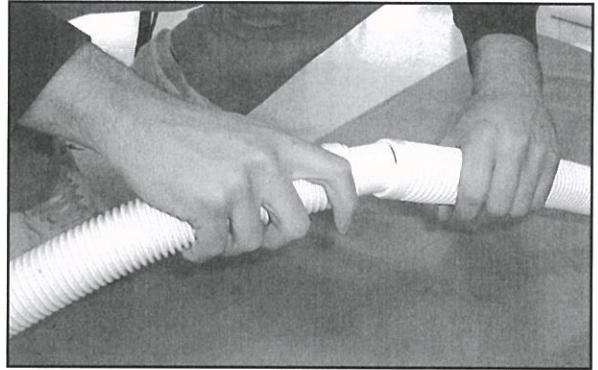

Figure 5

STEP 5 INSTALL AUTOMATIC REGULATOR VALVE

This is done by simply attaching the valve to the last section of hose. The advantage of using the valve is that it balances the flow of water between the skimmer and the cleaner. The valve is strongly recommended for maximum performance, however is only necessary in instances where there is excessive pump flow. Excessive suction will make the cleaner move too fast and could damage the vacuum's components and/or decrease the cleaner's ability to navigate the pool. In these instances the automatic regulator valve must be used. This will help restrict flow of water and make the cleaner operate more efficiently.

NOTE

Automatic Regulator Valve must be installed so the bypass port is always facing down and is below the water level.

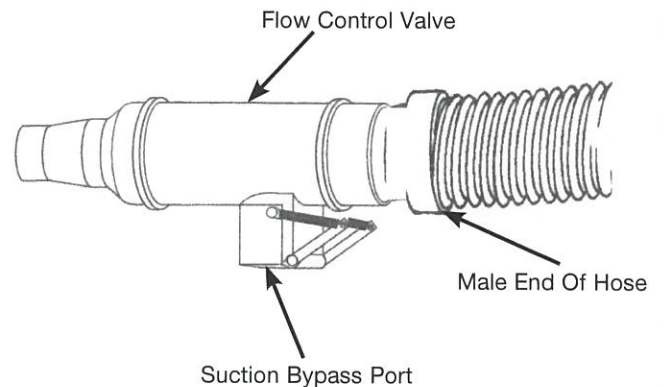

Figure 6

STEP 6 INSTALL EYEBALL DIVERTER

To install the eyeball diverter remove the original eyeball from the return by unscrewing the lock ring. Replace the original eyeball with the cleaner eyeball diverter. Replace the lock ring and tighten. The best way to position the eyeball diverter is so the flow is directed downward. This will help eliminate the return flow from interfering with the cleaner.

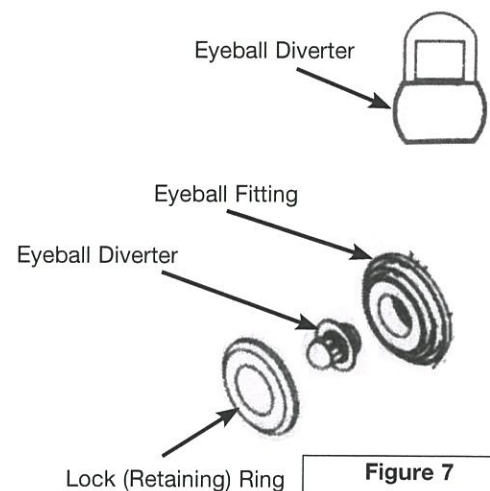

Figure 7

*Once fully assembled,
your Automatic Pool Cleaner
should look like this.....*



INSTALLATION

Your automatic pool cleaner is designed to work in a wide variety of swimming pools. There are items that may or may not be needed to be installed for your cleaner to function properly. All installations are covered in this manual. Find which type of installation matches your pool configuration and follow the instructions carefully.

For the cleaner to work properly, regardless of the installation type, the hose needs to be completely primed. The easiest method of priming the hose is to simply put the end of the hose up to your pool's return fitting (eyeball) with the pump running. The pump will force water through the hose and purge all of the air out. Keep the pump running until there are no air bubbles coming out the opposite side.

OPTION 1 SKIMMER VACUUM PLATE

This is the most common type of installation. This type of skimmer is provided with a vacuum plate that fits over the skimmer basket. The plate has an elbow. Place the end of the Automatic regulator valve over the elbow. Make sure that the bypass post on the valve is facing down.

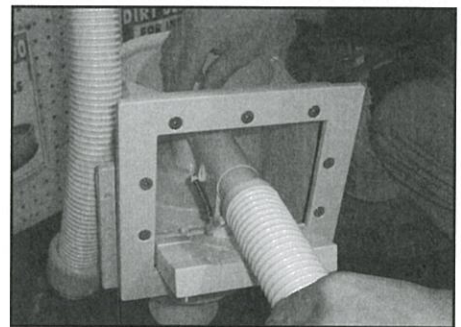

OPTION 2 INSIDE SKIMMER OUTLET

For skimmers that do not use a vacuum plate. Attach the end of the automatic regulator valve into the 2" hose cone. The 2" hose cone is then inserted into the bottom of the skimmer

NOTE

Make sure the cone fits snugly inside the bottom of the skimmer.

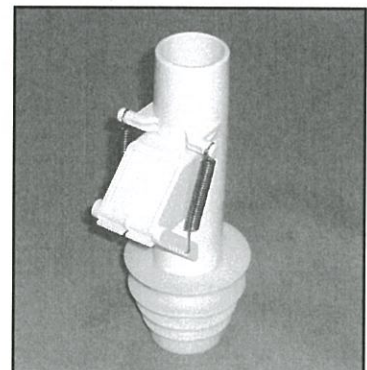

HOSE BALANCE

You will also need to attach hose weights to neutralize the hose's buoyancy in the water. For inground pools all three weights are typically needed. The first weight should be placed on the first section of hose between 4 and 12 inches from the body's swivel head. The next two weights should be positioned 6 feet and 10 feet from the body respectively. The hose weights may need to be adjusted depending on the style of your pool.

With the cleaner off, the hose balance is correct when the cleaner's seal rests flat on the pool floor and the main body makes a 45 degree angle with the pool floor. The cleaner will achieve the best performance when the hose neither weighs down or pulls up the unit. Adjust the weights one inch at a time as needed, until the proper hose balance is achieved.

- **HOSE IS TOO LIGHT** — If the hose rises towards the surface at an angle greater than 45 degrees, move the weight closer to the cleaner.
- **HOSE IS TOO HEAVY** — If the hose sags downward at an angle less than 45 degrees, move the weight away from the cleaner.

HELPFUL HINTS

- For pools with 2 suction lines (i.e. main drain and skimmer or 2 skimmers) it is necessary to close off the suction line not being used for the cleaner. This can be done by turning off the valve for the main drain, or using a skimmer bypass plate to restrict the flow of water.
- As your vacuum cleaner removes debris from the pool and it is collected in your filter, you may notice the vacuum operating slower than normal and a reduction in flow from the return. Make sure that you periodically check your filter pressure and backwash your filter or clean your filter element as needed.
- Remove as many obstructions as possible including ladders, floats, or any other items that may be in the pool and could limit the cleaner's ability to navigate the pool.
- Do not coil hose when taking the cleaner out of the pool. The hose may retain the shape, forming a bend or kink which will hinder the cleaner's performance.

VACUUM WINTER STORAGE

Remove your vacuum from the pool and dry completely. Disassemble the hose sections and store in the original box, or lay the hoses out on a flat surface. NEVER store the hose in a coiled position as it may retain the curved shape, not allowing the vacuum to operate efficiently. Store the vacuum so the pleated seal lays flat, or remove the seal and store it in a flat position. Store all parts indoors.

REMOVING DEBRIS FROM THE FLAPPER

Sometimes debris may clog the bottom of the cleaner and prevent the flapper from moving. This will restrict the flow of the cleaner. The flapper is located inside the main body and must move freely at all times. You can see the flapper through the opening in the baffle plate when the cleaner is turned upside down. Try to free the flapper by moving it back and forth, or flush the cavity of the cleaner free with a garden hose. This will remove any debris that may be lodged inside the cleaner.

If debris is still lodged inside the cleaner, you must remove the flapper. To do this you must take out the four red plugs in the foot pad. These are found on the bottom of the cleaner. They can be removed using a flat head screwdriver. Underneath there will be four screws. Unscrew them and remove the foot pad from the main body. Once removed there is a plate. Remove the single screw from this plate and slide it out of the main body. This will expose the flapper and it can be pulled out.

Remove any debris that may be inhibiting the flapper. Once dislodged insert the flapper back into the body. Slide the plate back into position and re-screw it into place. Then re-install the foot pad. Make sure that all are securely in place.

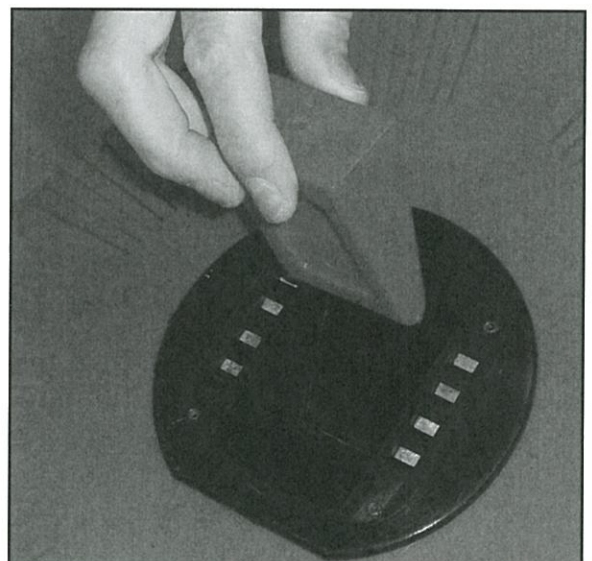
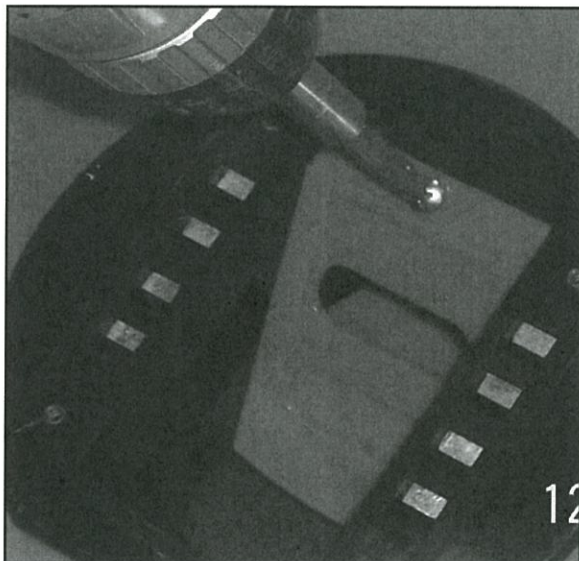
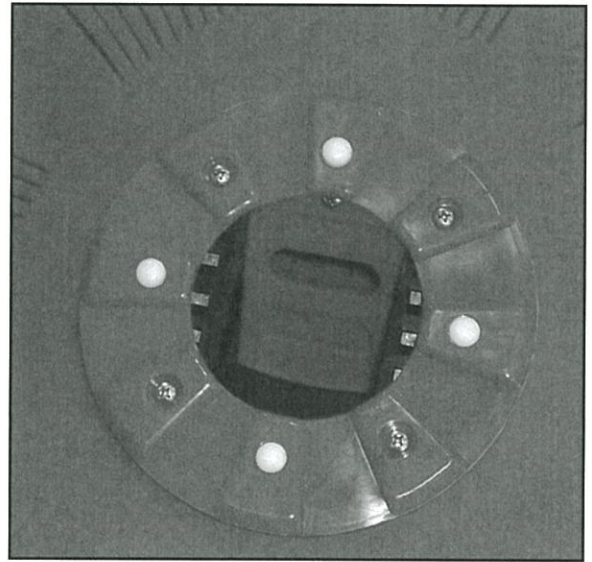
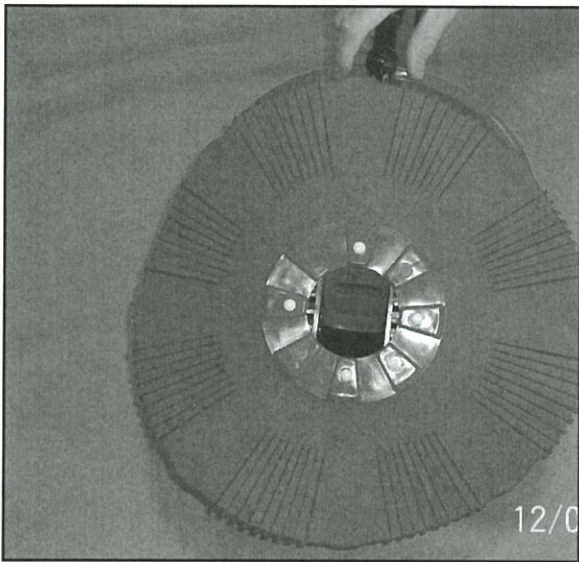

TROUBLESHOOTING

PROBLEM	POSSIBLE CAUSE	SOLUTION
1. Vacuum moves too slow or not at all	<ul style="list-style-type: none"> • Filter is dirty. • Skimmer or pump strainer baskets are clogged with debris. • Vacuum flapper clogged with debris. • Automatic regulator valve stuck in open position. • Crack or air leak in hose. • Excessive debris on pool floor. • Suction coming from multiple ports. 	<ul style="list-style-type: none"> • Backwash or clean element. • Empty baskets out. • Turn cleaner over and remove debris. • Remove obstruction or replace if broken. • Replace hose section. • Remove by manually vacuuming or with leaf rake. • Check to ensure main drain and all suction lines are closed, except for suction line to which the cleaner is attached.
2. Vacuum moves too fast	<ul style="list-style-type: none"> • Automatic regulator valve stuck in closed position. • Automatic regulator valve not installed. 	<ul style="list-style-type: none"> • Clean automatic regulator valve port and hinge. • Install automatic regulator valve.
3. Vacuum cleans one end of pool but will not clean entire pool	<ul style="list-style-type: none"> • Insufficient number of hose sections. • Return flow interfering with cleaner. • Cleaner not weighted properly. 	<ul style="list-style-type: none"> • Add hose sections. • Make sure eyeball diverter is installed and facing down. • Add or adjust hose weights as needed.
4. Vacuum turns over	<ul style="list-style-type: none"> • Excessive flow currents. • Contacting an obstruction in pool. • Hose too long. 	<ul style="list-style-type: none"> • Make sure eyeball diverter is installed and facing down. • Remove obstruction. • Remove hose sections one section at a time