

## AC 30473 — OUTSIDE LADDER

FOR USE WITH:

# CAYMAN ENTRY SYSTEM

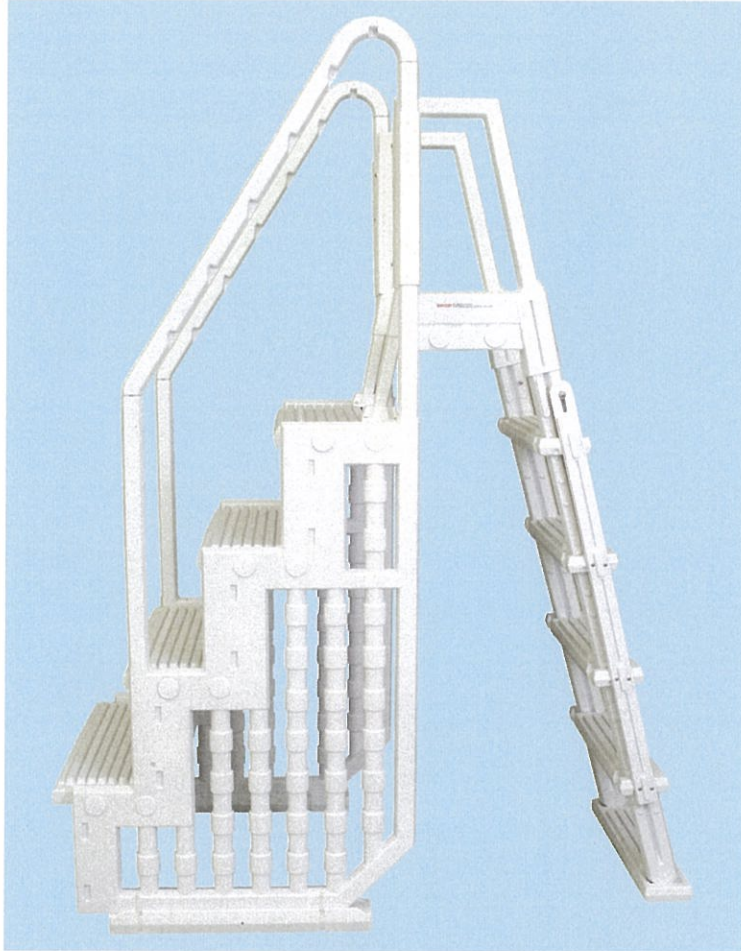

This enclosed ladder will attach to the universal step (**AC 30163**). Please open the step carton and assemble the step per the instructions. Refer to this book for instructions on the assembly and attachment of the ladder when instructed in step manual.

**NOTE** This ladder may be added onto the Blue Hawaiian step to create an A-frame entry system in the event that a step only is no longer acceptable for use.

### TOOLS REQUIRED

- Drill with 1/8" drill bit
- Small rubber mallet or hammer w/piece of wood
- Phillips head screwdriver
- Pliers
- Spray lubricant or liquid soap

## PARTS & HARDWARE FOR STEP

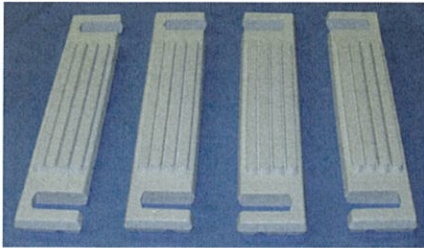

**A. UPPER STEP (4)**  
(AC MKSTEP)

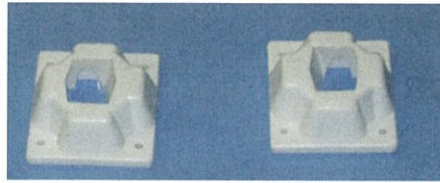

**B. MOUNTING BLOCKS (2)**  
(AC MTBLOCK)



**C. ADJUSTABLE TUBE (2)**  
(AC ADJTUBE)



**D. HANDRAIL (2)**  
(AC HANDRAIL)



**E. LEG (2)**  
(AC MKLEG)



**F. PLATFORM**  
(AC PLATFORM)



**G. BOTTOM STEP**  
(AC BTSTEP)



**H. RIGHT & LEFT STEP CONNECTORS**  
(1-AC STEPCONR & 1-AC STEPCONL)



**I. SHIELD**  
(AC SHIELD)

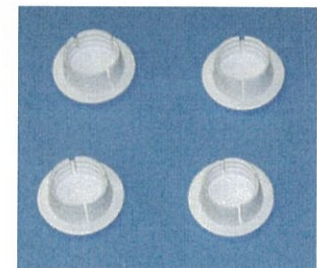

**J. LOCKING CAP (4)**  
(AC LOCKCAP)

### HARDWARE

(AC HDW30474)

- 40- #10 x 1-1/4" screws
- 4 washers
- 2- bolts
- 2- acorn nuts

# CAYMAN ENTRY SYSTEM PARTS

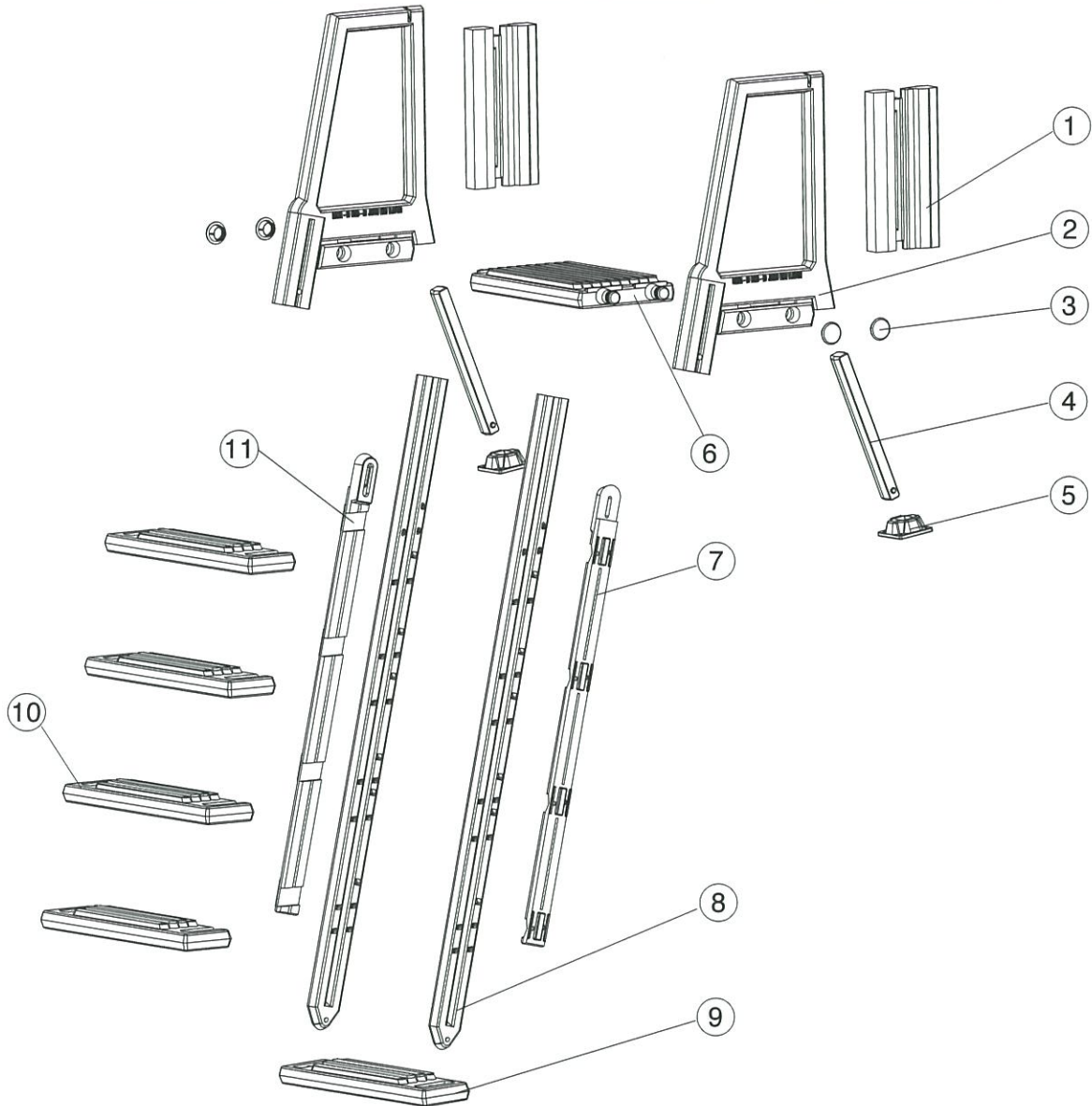

PART #	MODEL #	DESCRIPTION	QTY
1	AC SHIELD	Shield	2
2	AC HANDRAIL	Handrail	2
3	AC LOCKCAP	Lock Caps	4
4	AC ADJTUBE	Adjustable Tube	2
5	AC MTBLOCK	Mount Block	2
6	AC PLATFORM	Platform	1
7	AC STEPCONR	Right Step Connection	1
8	AC MKLEG	Molokai Leg	2
9	AC BSTEP	Bottom Step	1
10	AC MKSTEP	Mid Steps	4
11	AC STEPCONL	Left Step Connection	1

# IMPORTANT SAFETY INSTRUCTIONS PLEASE READ PRIOR TO ASSEMBLY/USE

The Ladder must be installed based on **Manufacturer's Instructions**

- One person on the Ladder/Stair at a time
- This Ladder is designed and manufactured for a specific Pool Wall Height and/or Deck of the Pool
- For Entry/Exit of pool, face the ladder at all times
- Remove and secure Ladder when pool is not occupied
- The Ladder will be suitable up to 54" Maximum Pool Height

## STEP 1

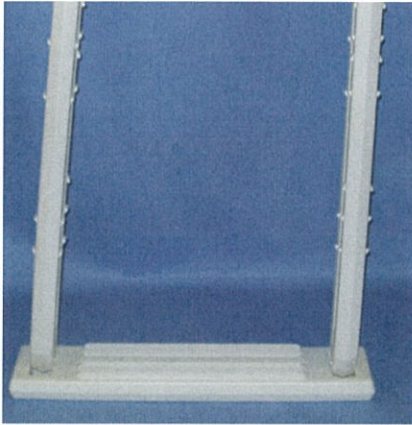

- Place the bottom step (**G**) on a level surface with indentations facing up.
- Take leg (**E**) and stand upright (pointy side down). When installed on bottom step, the leg will need to have the raised areas facing inward. The raised area with the pre-drilled screw hole should be at the front of the ladder toward the top of the leg.
- Place the left leg into the indentation on the left side of the step and push straight down until it clicks into place.
- Repeat above for right leg on right side of step.

## STEP 2

- There are two sets of lug locations on the stringers in the areas where each step will be installed. Each step should be installed into the UPPER set of lugs only.
- Locate one of the four groups of lugs and slide step (**A**) into the upper set of lugs on the legs so it clicks into place.
- Repeat for each of the remaining (3) steps.
- Secure the top step **ONLY** by drilling (1) 10 x 1-1/4" screw into each side of the step through the pre-marked leg openings.

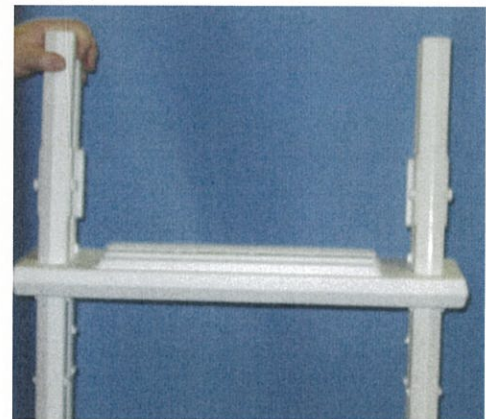

**NOTE** The bottom three steps remain unsecured. They will be secured in Step #4. These steps make up the "Flip Up" outside portion of the ladder.

## STEP 3



- Put ladder aside for now and install handrails (**D**) onto platform (**F**).
- Lay one handrail on flat surface and push the connected dowels of the platform into the openings on the handrail until fully seated. Make sure treads of platform are facing upward.
- Before attaching second handrail, make sure that the longer part of the handrail is facing in the same direction on both handrails. Repeat above for installation of second handrail.

- Center locking cap (**J**) over opening on side of handrail where platform was just attached. Using a rubber mallet or a hammer and a small piece of wood, tap on cap until the cap is flush with the handrail
- Repeat for each of the remaining (3) locking caps.



## STEP 4



- Coat the tops of the legs with lubricant and attach handrails by pushing them down over the legs. Secure with (4) #10 1-1/4" screws through each of the pre-marked openings.
- Locate step connectors (**H**) which will be installed to hold the steps in place. There is a right and a left step connector, they are NOT interchangeable. The angle of the connector will allow for installation on only ONE side of the steps. Check the top of the connectors for the raised left and right markings.
- Line up rounded area of left step connector with predrilled hole at top of leg. Remember, only one of these connectors will fit properly on the left side.

## STEP 4 - CONT.



- Place washer on bolt and insert from INSIDE of ladder thru leg and step connector. Insert second washer on end of bolt and screw on nut. Do not over tighten.
- Repeat above steps for the right step connector with remaining bolt, washers and nut.
- To attach step connectors to steps, secure with (2) #10 x 1/4" screw through each pre-marked opening on step connectors into steps on left and right sides.
- To attach the step connectors to the remaining (3) three steps, screw through each pre-marked opening on step connectors into the steps on the right and left sides. This will complete the "Flip Up" portion of the outside ladder.

## LADDER SWINGS UP AND LOCKS IN PLACE

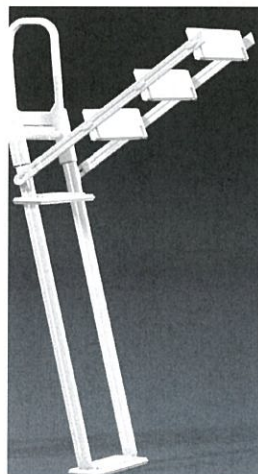
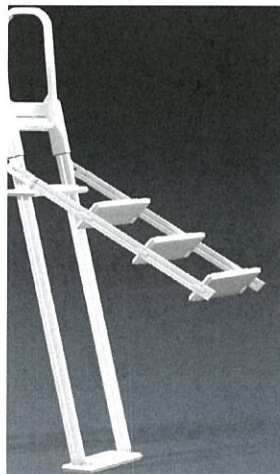
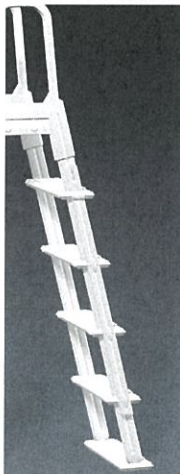

## STEP 5

- To attach the ladder to the step assembly, you will need to attach the shield (I).
- Line the shield up above the handrail and push it down so it slides onto the handrail. Repeat for opposite side.
- Rotate shield 90 degrees, so that the open sleeve of each shield is on the outside (like shown).



## STEP 6



- Once shields are situated properly, lift ladder up and line up the openings of shield with long handrail posts of the step.
- Slide the ladder down until it rests on ground outside.

- Coat adjustable tube **(C)** with lubricant and slip (1) mounting block **(B)** all the way down over the nubs on the tube. The open side should be exposed.
- Repeat for second adjustable tube and mounting block.

OPEN  
END

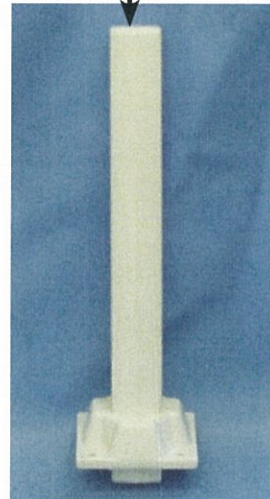

- Push one adjustable tube into the longer part of each handrail. The mounting block should sit on the top step to hold the ladder in place. Secure into handrail using (4) #10 1-1/4" screws in pre-marked openings.
- Secure each mounting block to the top step of the staircase using (4) 10 1-1/4" screws per mounting block.
- Fasten the shields to the handrails using (8) #10 1-1/4" screws (4 per side).

## STEP 7



- Lubricate inside of long and short handrail posts on step with liquid soap or lubricant.
- Attach handrails **(D)** from step box **(AC 30163)** to handrail posts by pushing into posts. The more curved part of the handrail is meant to be installed in the long handrail post.
- Using (4) screws from step box **(AC 30163)** hardware bag **(J)**, secure handrails in place.



**NOTE** When pool is not in use, always make sure that the outside ladder is in the upright position to limit access to ladder.

## SAFETY INFORMATION

- When lifting heavy or awkward loads, it is suggested that two people lift to avoid injury.
- **DO NOT** use the pool entry system for any purpose other than that for which it is intended.
- Maximum weight on steps should **NOT** exceed 350 lbs.



**WARNING** Exceeding the recommended weight limit may cause the step to fail and may result in injury.

## MAINTENANCE

- Step/ladder/bridges must be removed for winter, failure to do so can cause the step to crack.
- When removing step/ladder/bridges for winter, it is recommended that you spray down step with hose water to rinse off any chemical residual prior to storing.
- When storing step/ladder/bridges for winter, it should be protected from the elements and stored either in a shed or garage, or covered with a tarp.



# WARNING

This ladder is designed and manufactured for  
**Aboveground,  
Semi-Inground  
Flat Bottom  
Pools**  
48", 52" and 54"  
in wall height  
and pool decks  
48", 52" and 54"  
in height

# WARNING

**SAFETY  
NOTICE  
IMPORTANT**

# DANGER

Entry/Exit of  
Pool,  
Face the  
Ladder at  
all times

# DANGER

**PLEASE  
READ  
BEFORE  
USING  
THIS  
LADDER**

# DANGER

When  
**NOT IN USE**  
remove or  
secure ladder  
when the pool  
is not  
Occupied

# DANGER