















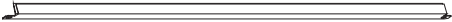
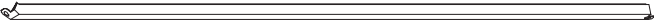

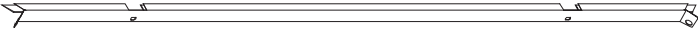
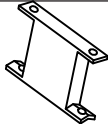
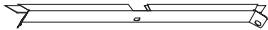

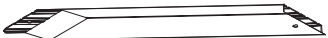

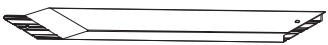

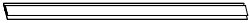



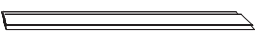
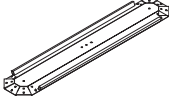

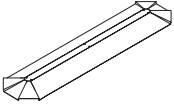





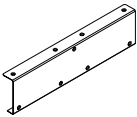
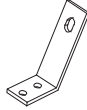
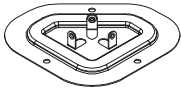

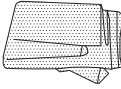
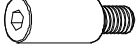
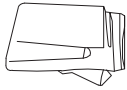

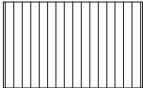

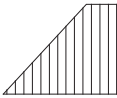
Item no.	Reference Image	Qty.
A		X4
B		X2
B1		X2
C		X2
C1		X2
Ea		X4
E1		X6
G		X2
G1		X4

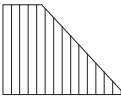
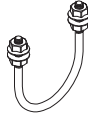
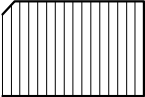
ASSEMBLY INSTRUCTIONS

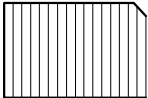
Item no.	Reference Image	Qty.
G2		X4
G4		X2
G6		X2

Item no.	Reference Image	Qty.	Item no.	Reference Image	Qty.
D1		X4	G5		X2
D2		X6	H		X4
Eb		X4	H1		X4
E2		X6	K		X4
F		X2	K1		X4
F1		X4	U		X128
F2		X4	L		X1
F3		X4	M		X1
F4		X4	N		X12
G3		X2	N1		X6

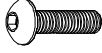
ASSEMBLY INSTRUCTIONS

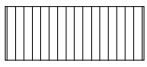
Item no.	Reference Image	Qty.	Item no.	Reference Image	Qty.
P		X4	W2		X6
J		X4	1	 M6X16mm	X168
S		X4	2	 M6X15mm	X16
T		X4	3	 M5X12mm	X16
Q		X4	4	 ST4.8X12mm	X16
Q1		X4	5		X2
Q2		X4	6		X1
Q3		X4	7	 M6X25mm	X1
Q4		X4	8		X12
Q5		X4	9		X1
Q6		X4	10	 M6X35mm	X8
R1		X4			
R2		X4			
R3		X2			

ASSEMBLY INSTRUCTIONS

1

X4



Ⓐ 4pcs

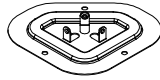

Ⓝ 4pcs



① 12pcs

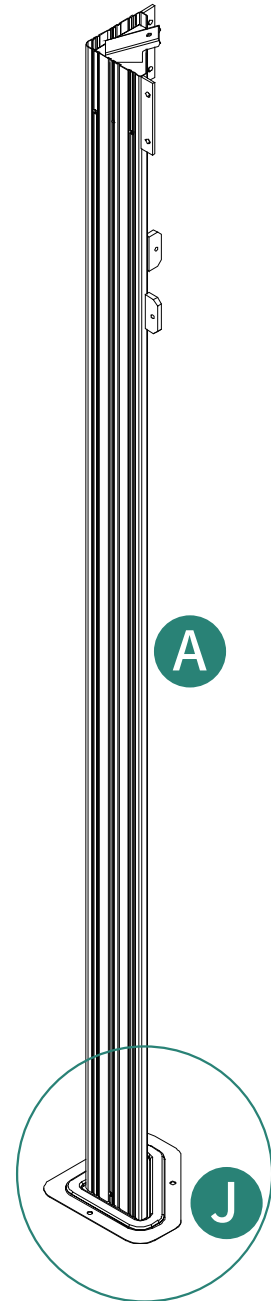
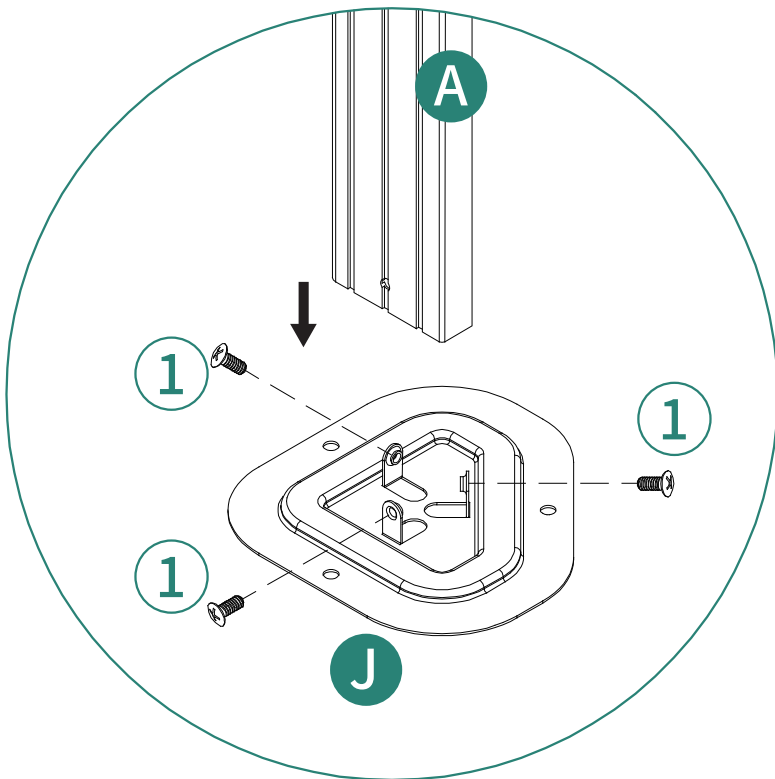

ASSEMBLY INSTRUCTIONS

2
X2

Ⓑ2pcs Ⓑ12pcs Ⓒ2pcs Ⓒ12pcs Ⓟ4pcs ①32pcs ②128pcs

When connecting B and B1 via P, C and C1 via P, make sure that 1 holes on part P (as shown in the picture) should be facing upwards. Do not install it upside down.

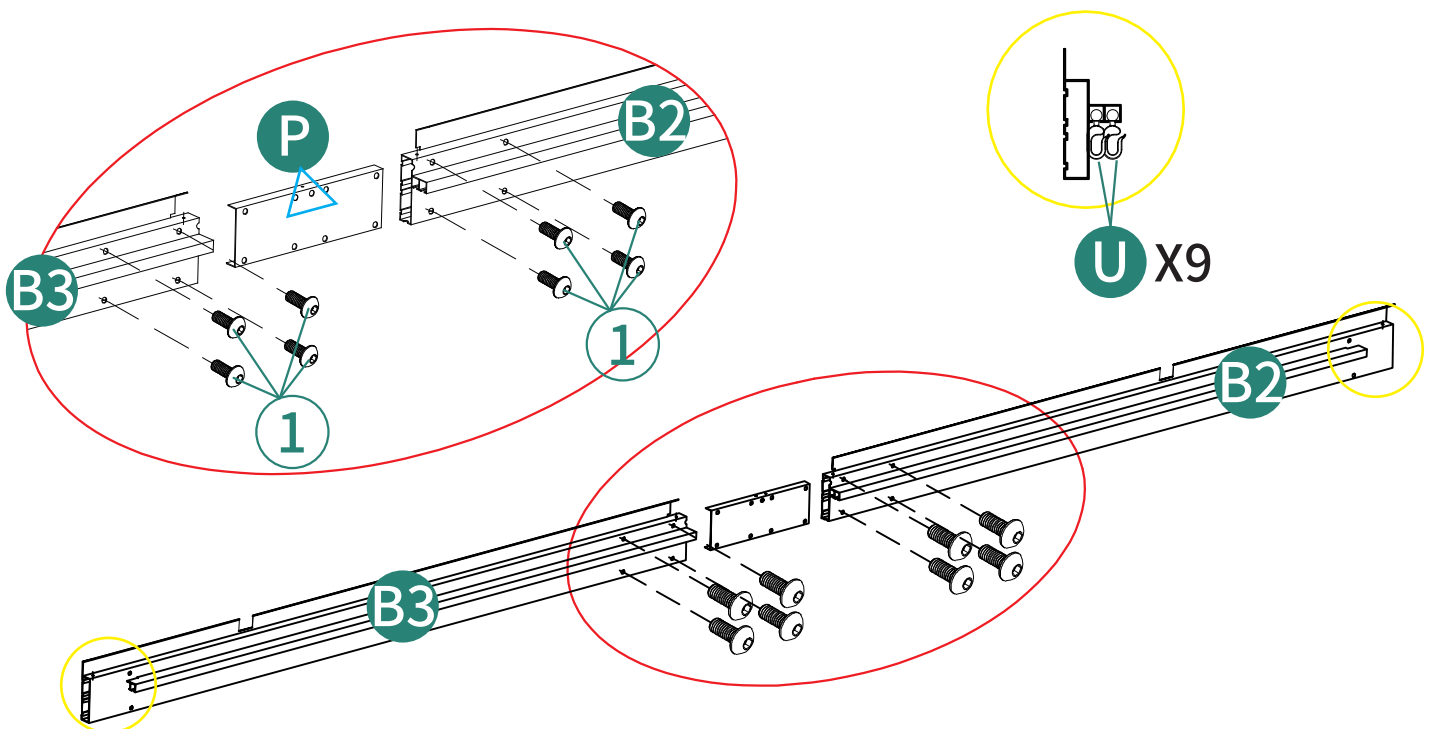
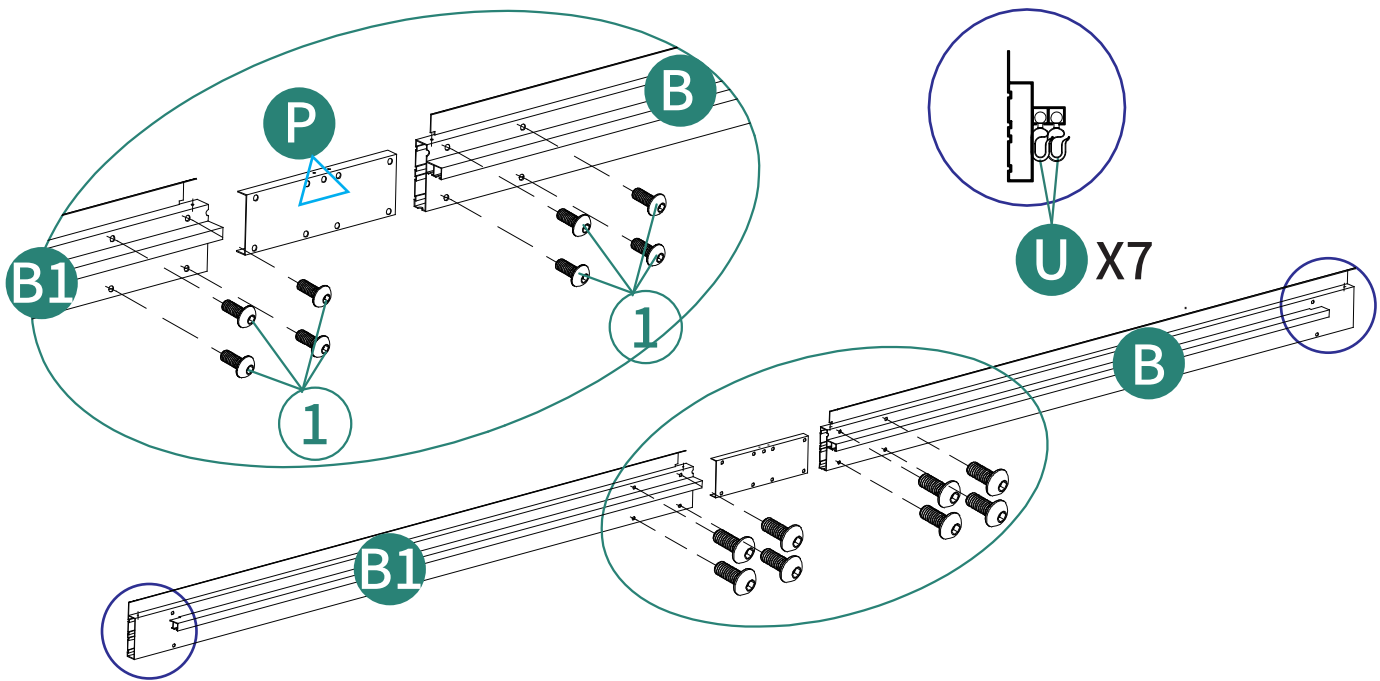

ASSEMBLY INSTRUCTIONS

3



① 16pcs ② 16pcs

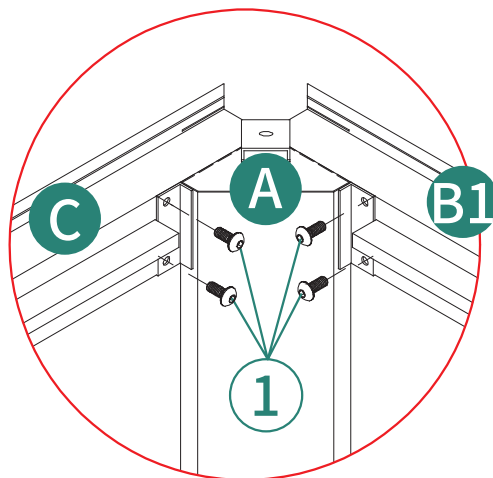
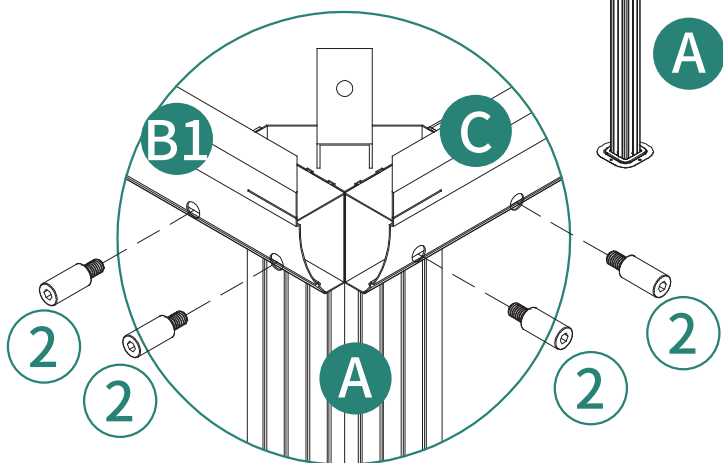
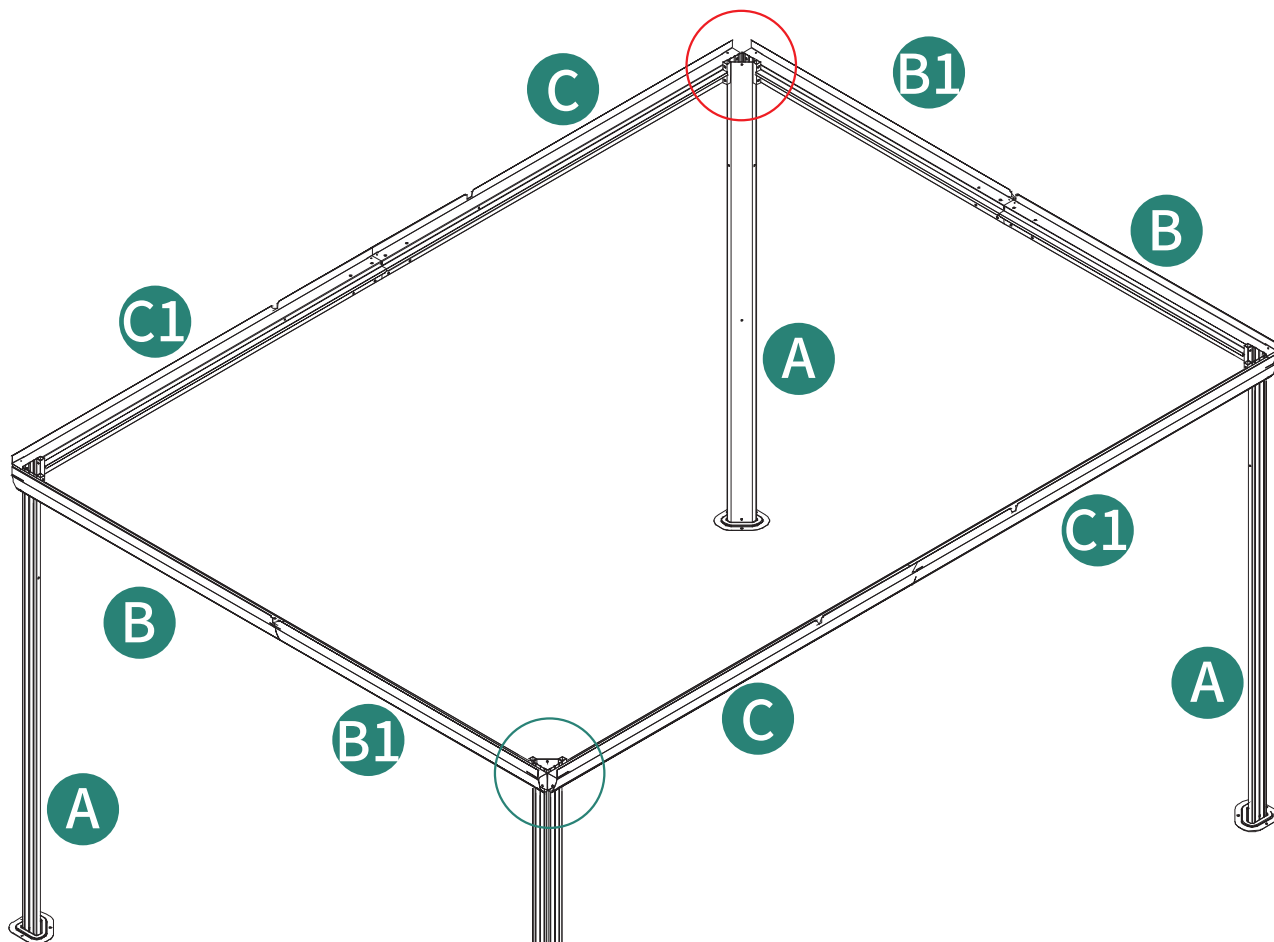

ASSEMBLY INSTRUCTIONS

4



(H) 4pcs



(H1) 4pcs



(1) 16pcs

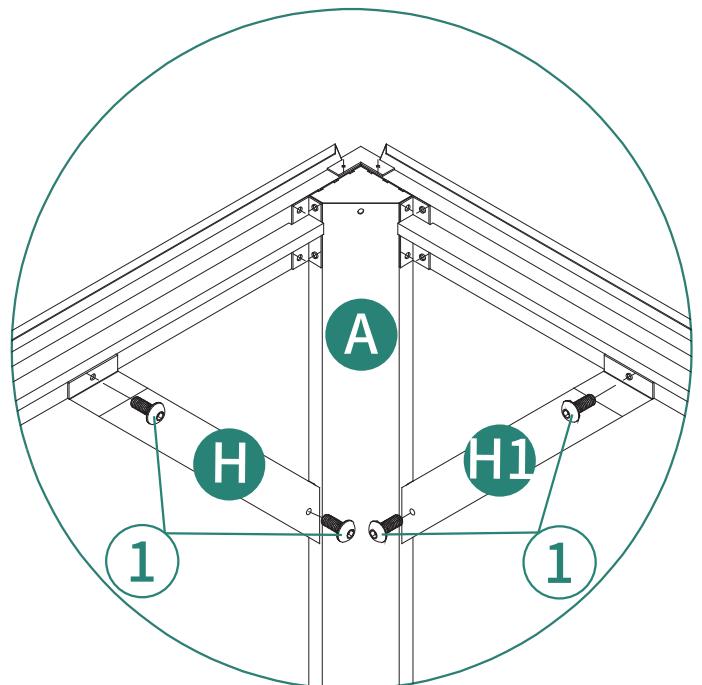
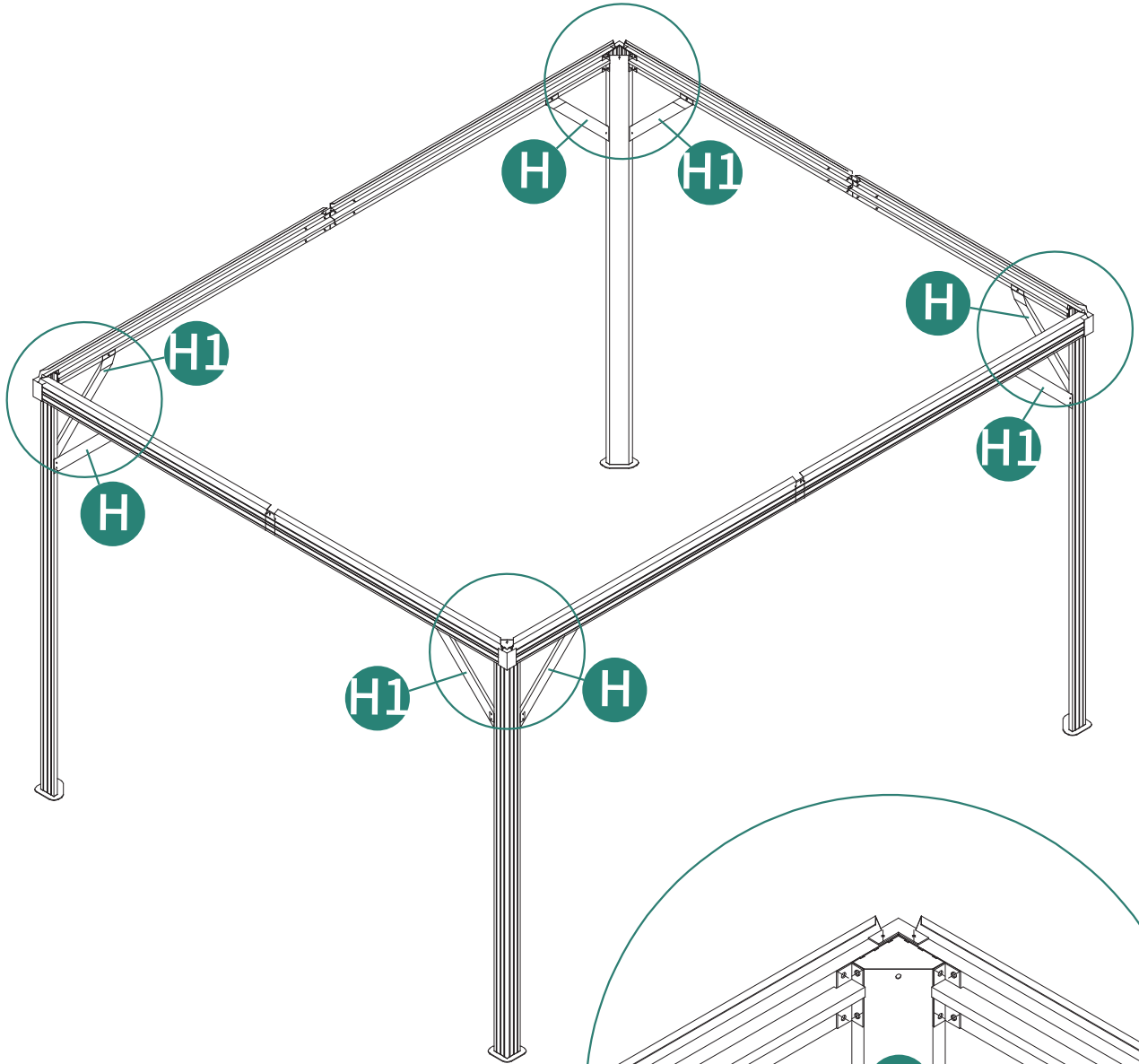

ASSEMBLY INSTRUCTIONS

5



(K) 4pcs



(K1) 4pcs



(4) 24pcs



(3) 4pcs

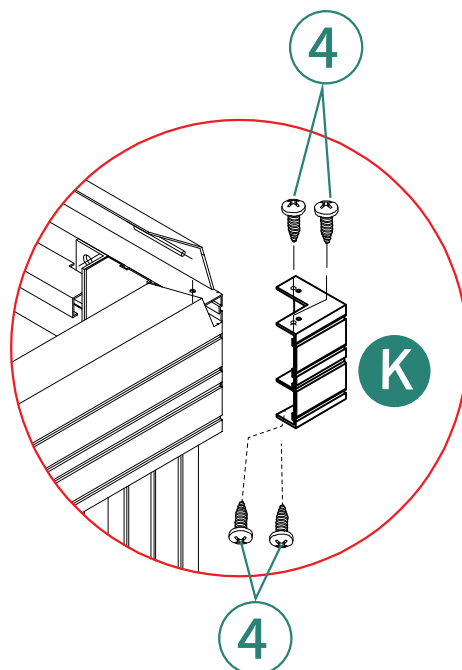
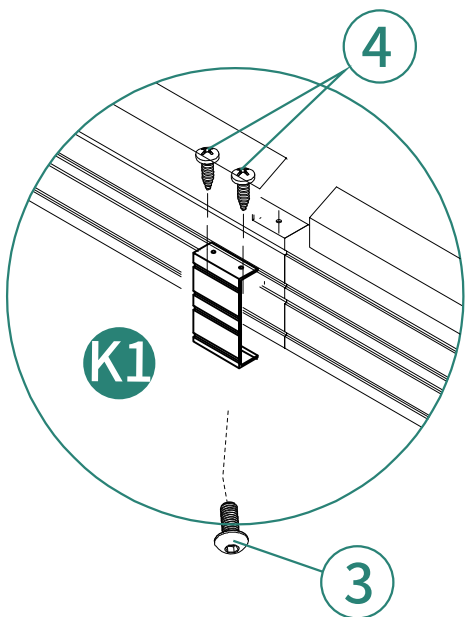
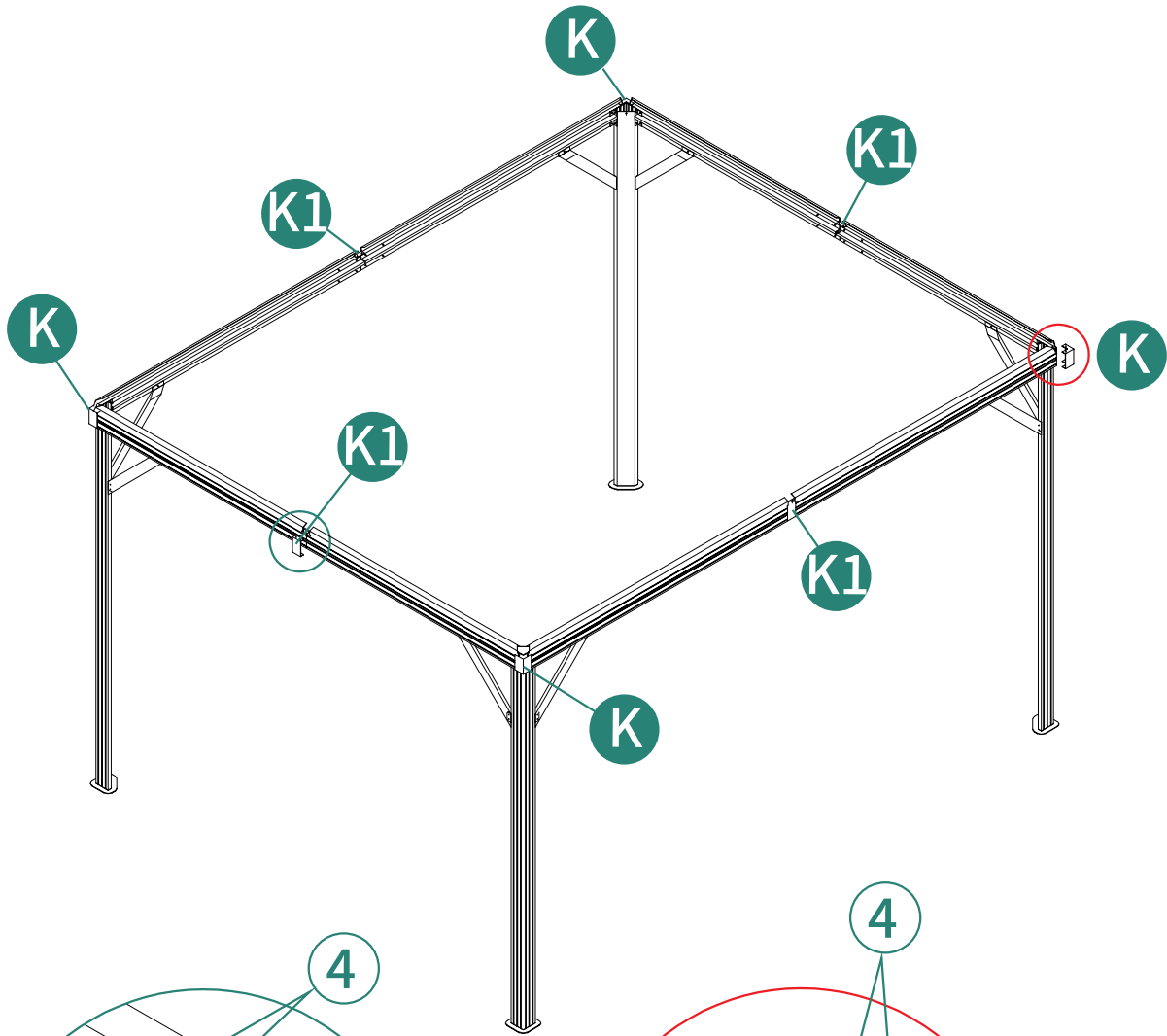

ASSEMBLY INSTRUCTIONS

6

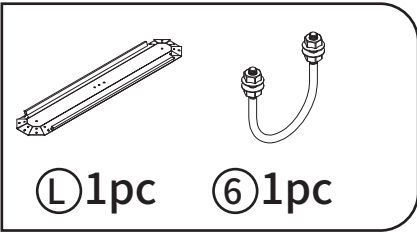

Ⓛ 1pc ⑥ 1pc

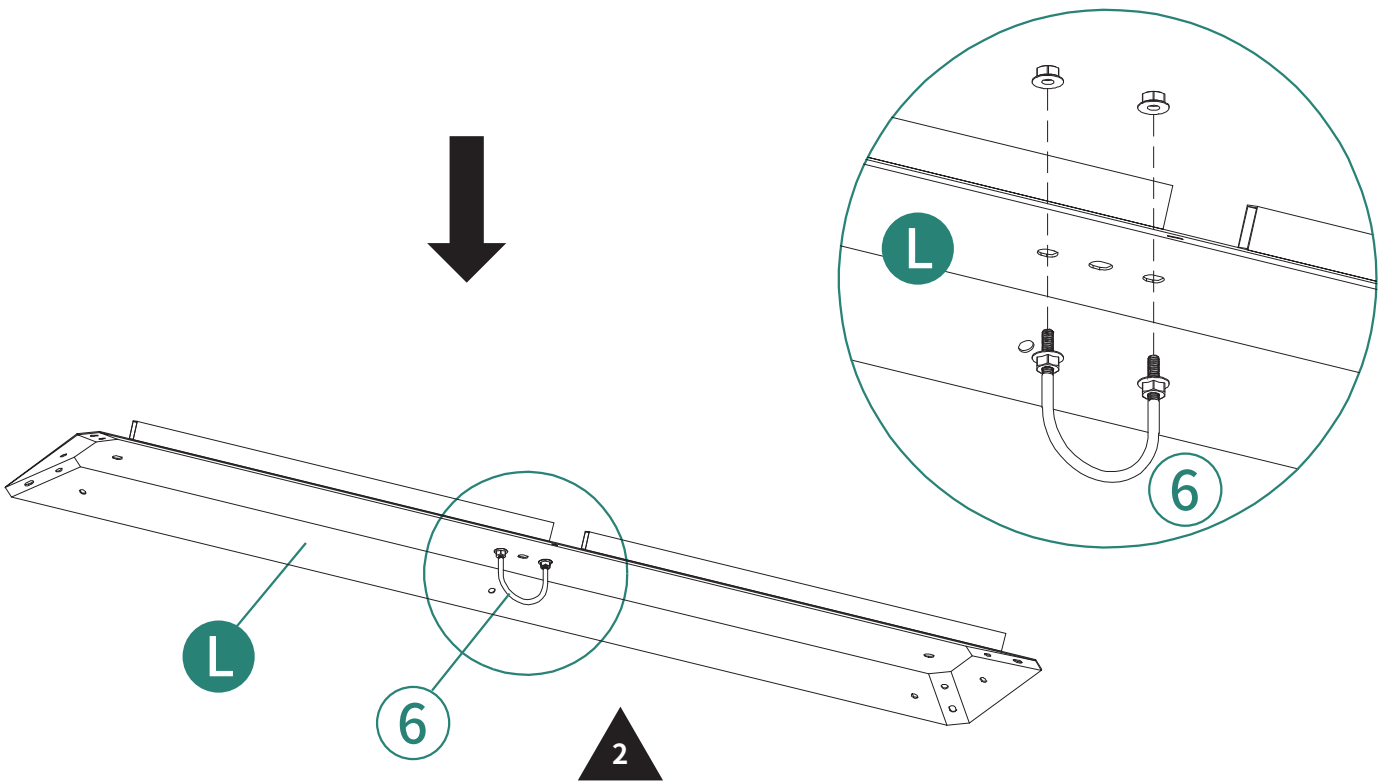
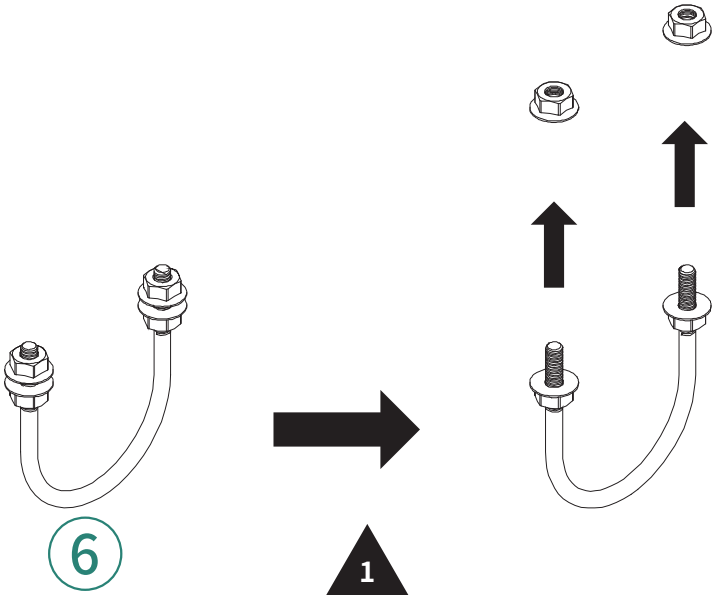

ASSEMBLY INSTRUCTIONS

7



Ⓔa 4pcs



Ⓔb 4pcs



Ⓓ1 4pcs



① 16pcs



⑩ 8pcs

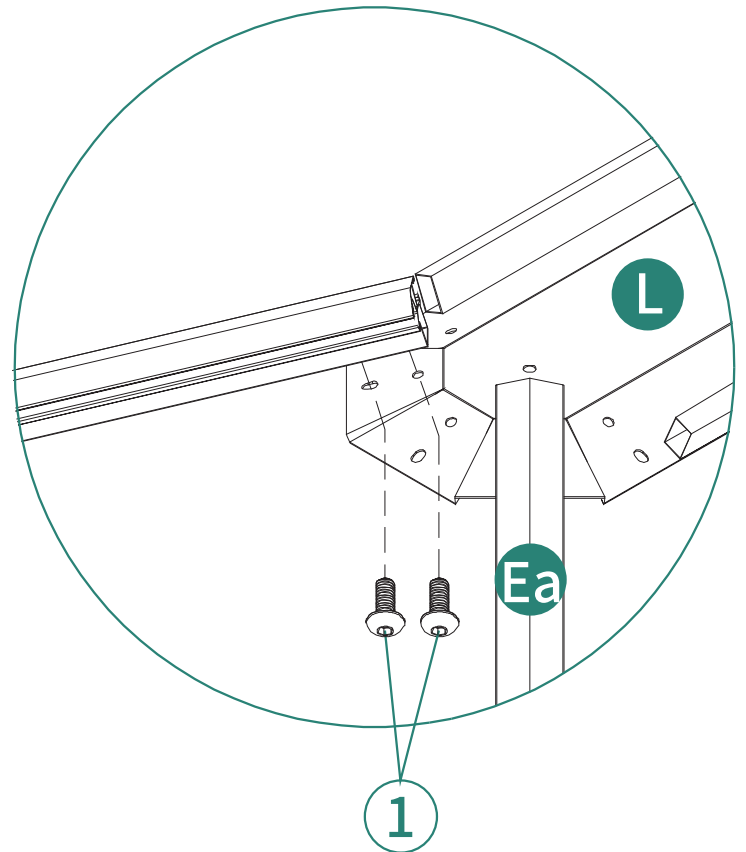
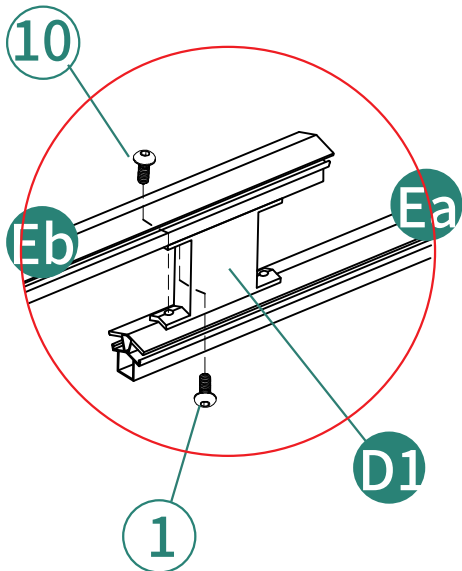
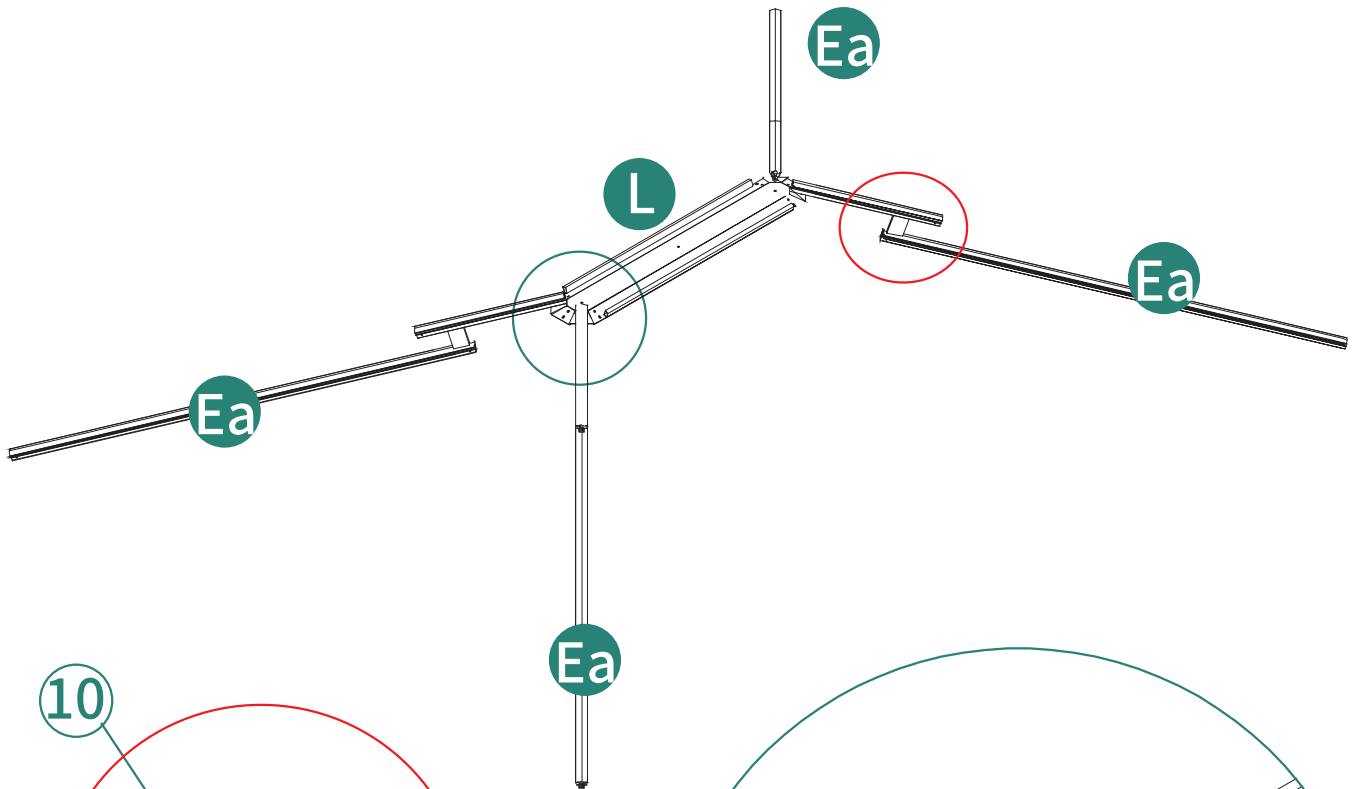

ASSEMBLY INSTRUCTIONS

8



① 4pcs

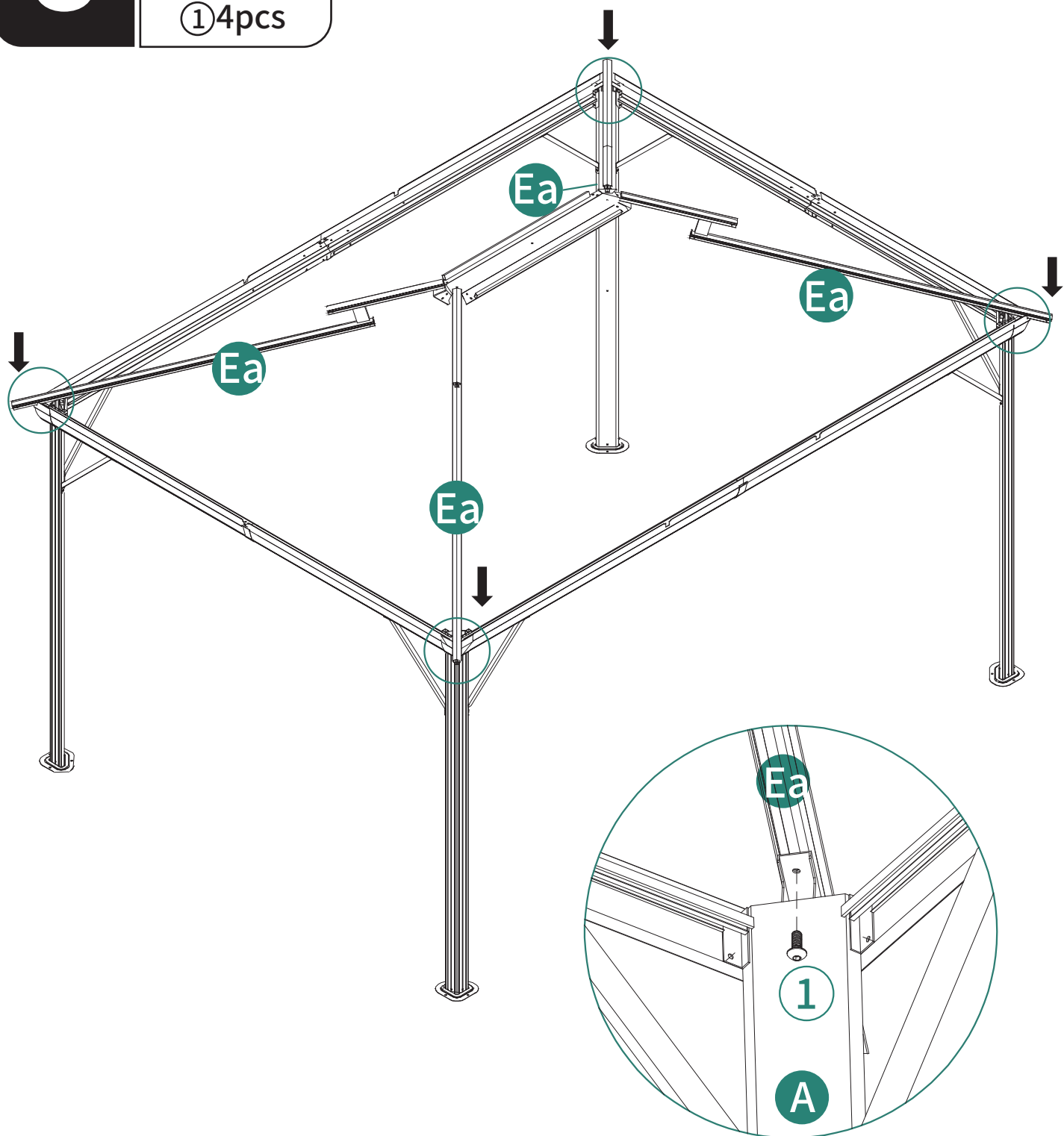

ASSEMBLY INSTRUCTIONS

9

X6

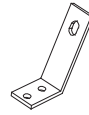

ⓔ1 6pcs ⓔ2 6pcs ⓓ2 6pcs ① 24pcs Ⓜ2 6pcs ③ 12pcs

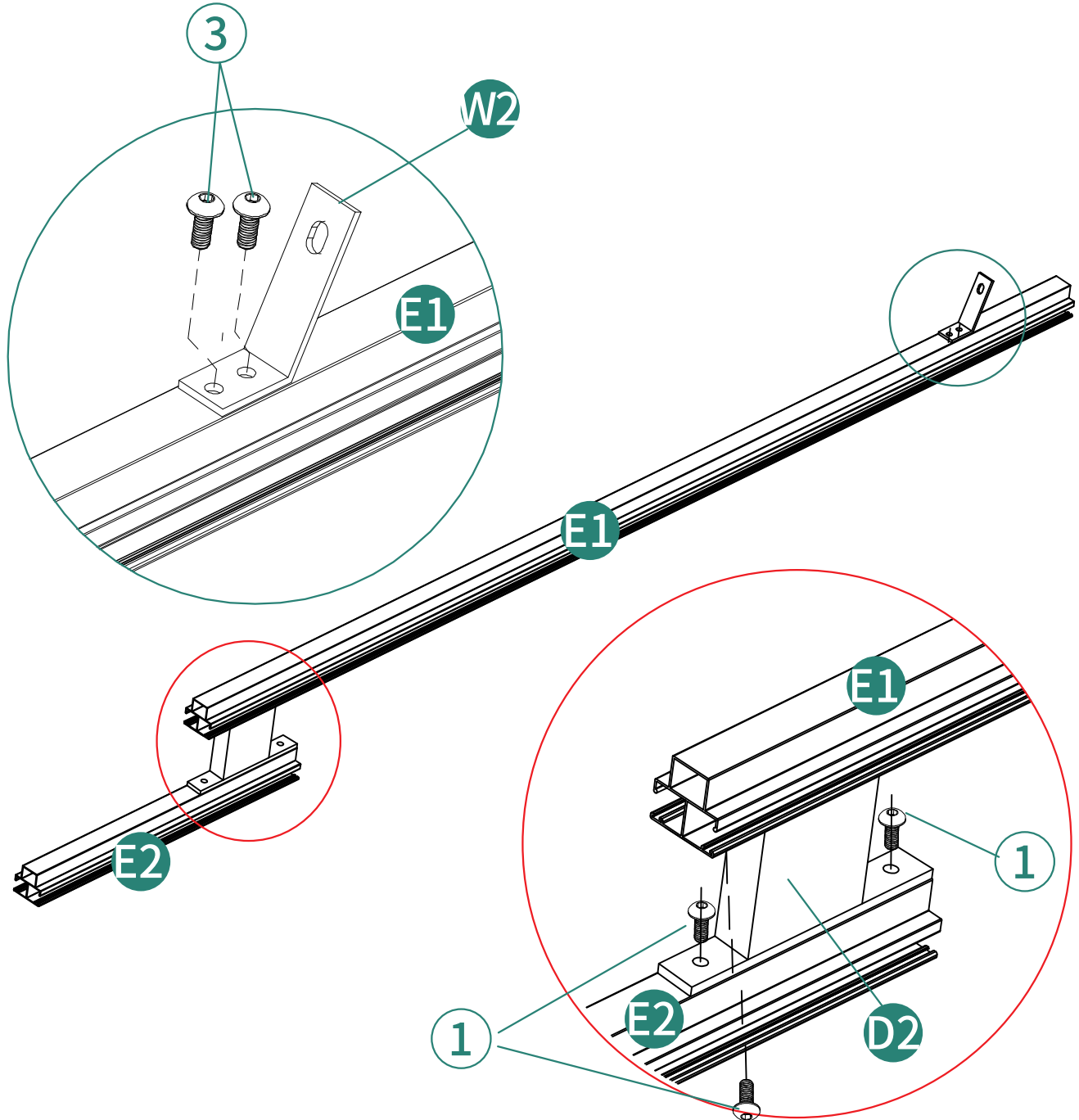

ASSEMBLY INSTRUCTIONS

10



① 18pcs

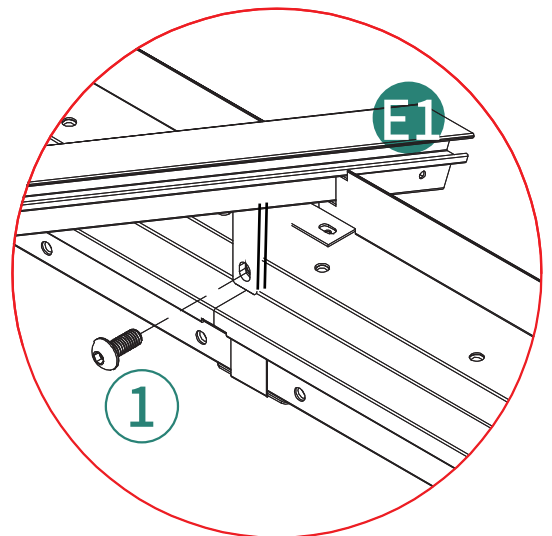
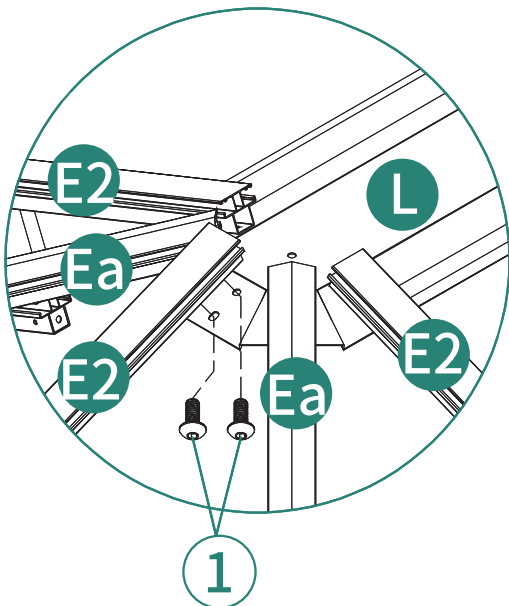
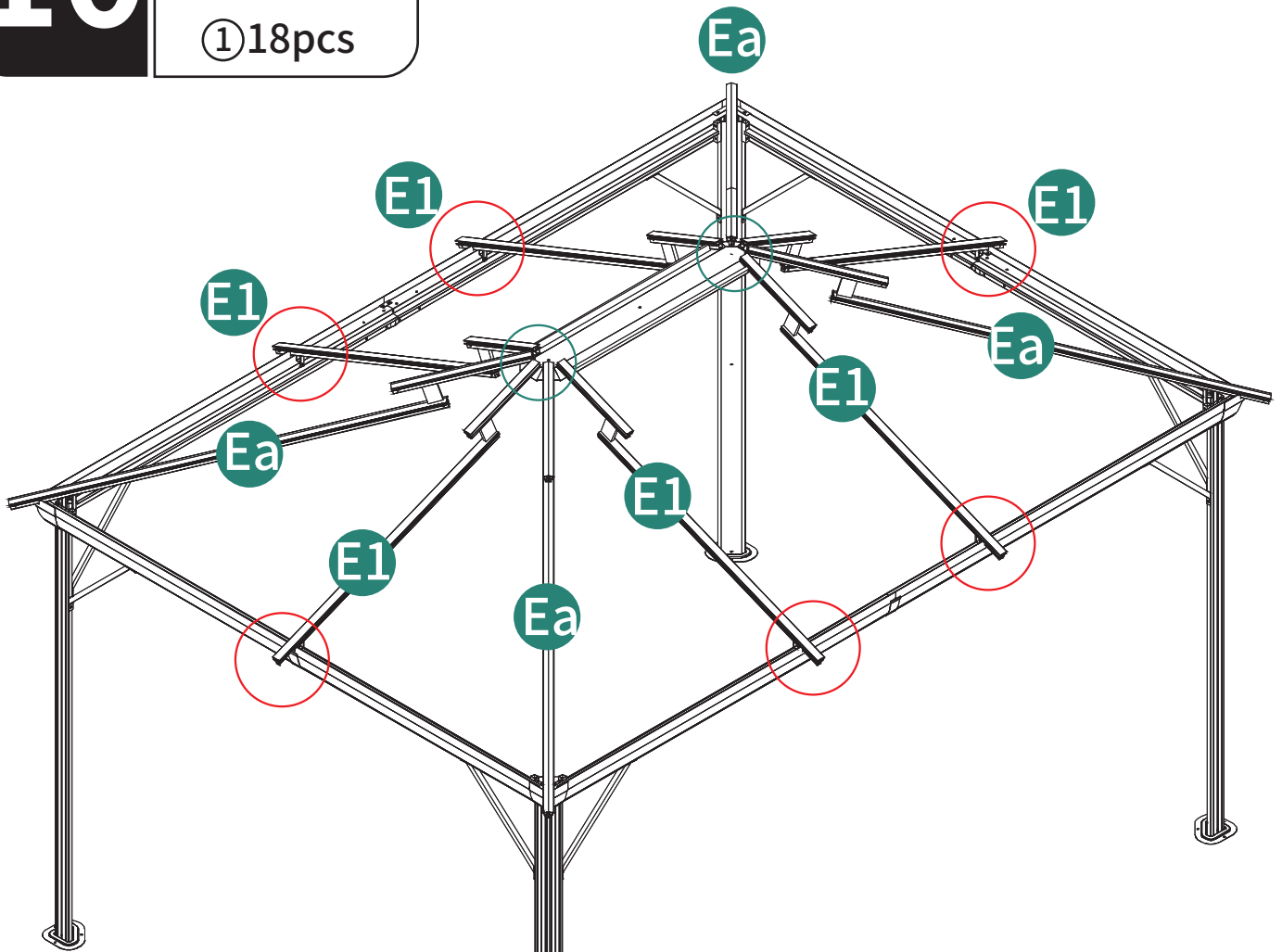

ASSEMBLY INSTRUCTIONS

11

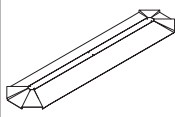

Ⓜ1pc



⑤2pcs



⑦1pc

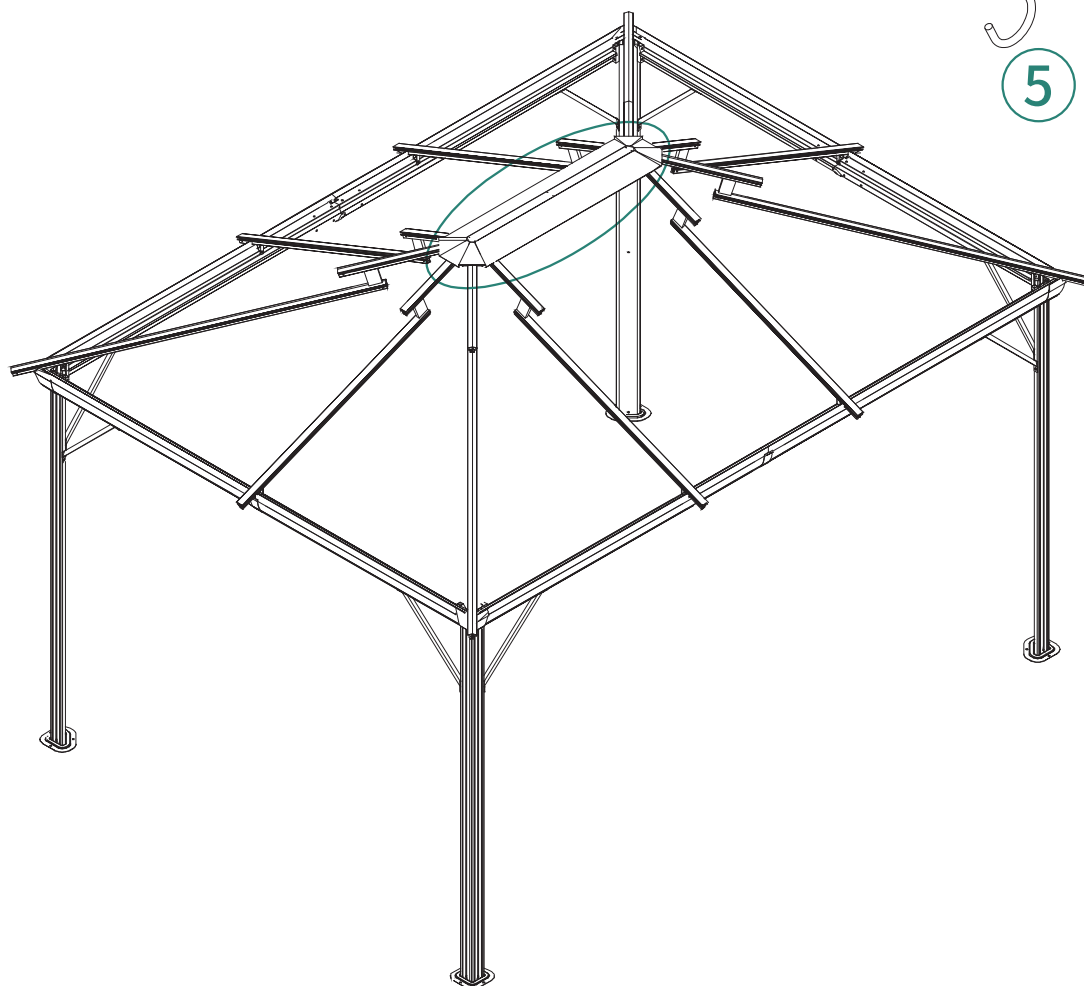
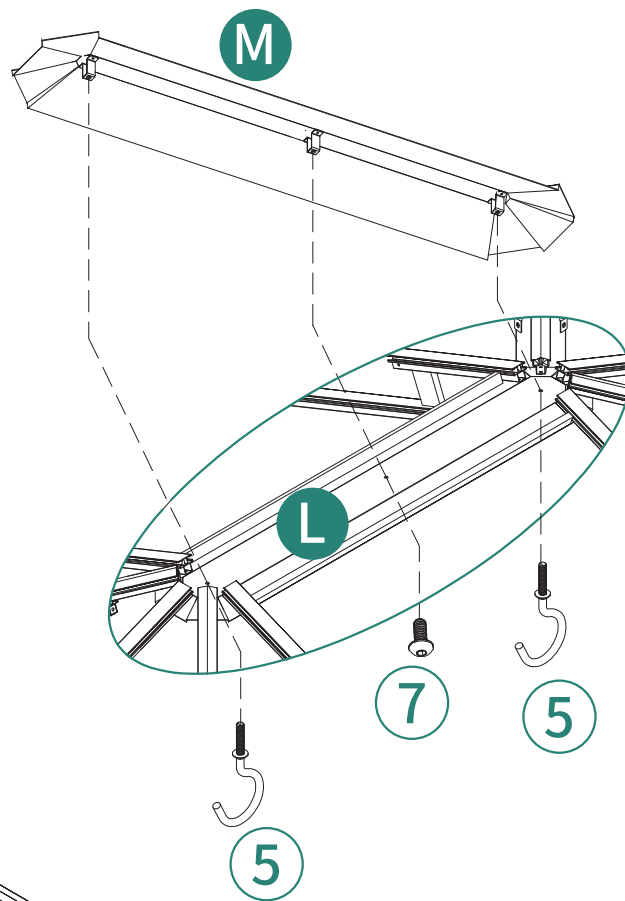

ASSEMBLY INSTRUCTIONS

12

G5 2pcs G6 2pcs N 4pcs 1 10pcs

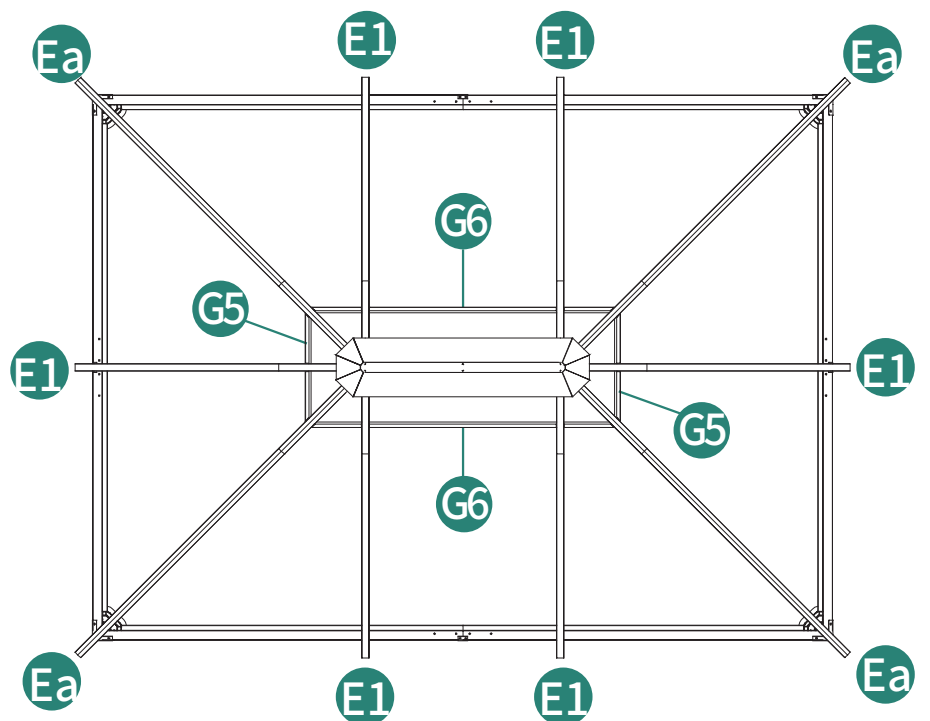
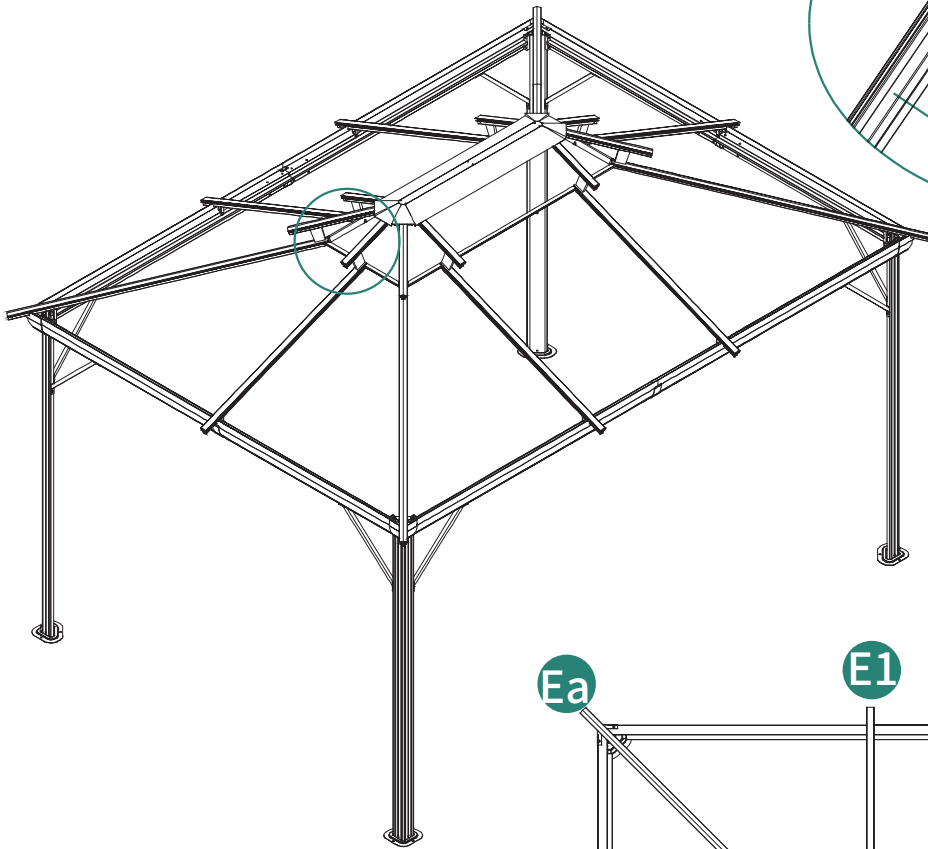
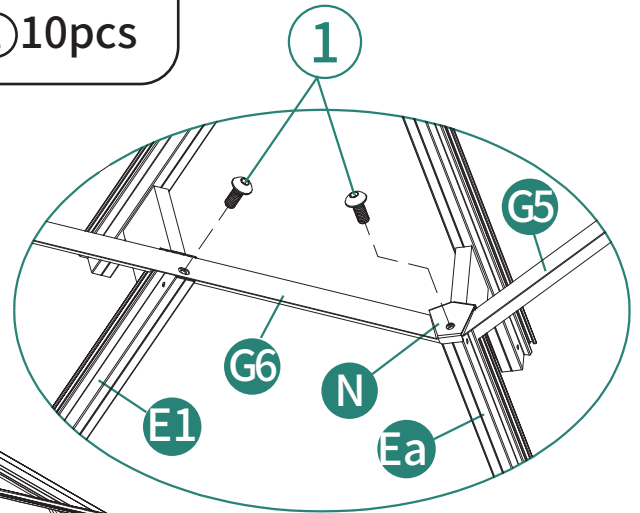

ASSEMBLY INSTRUCTIONS

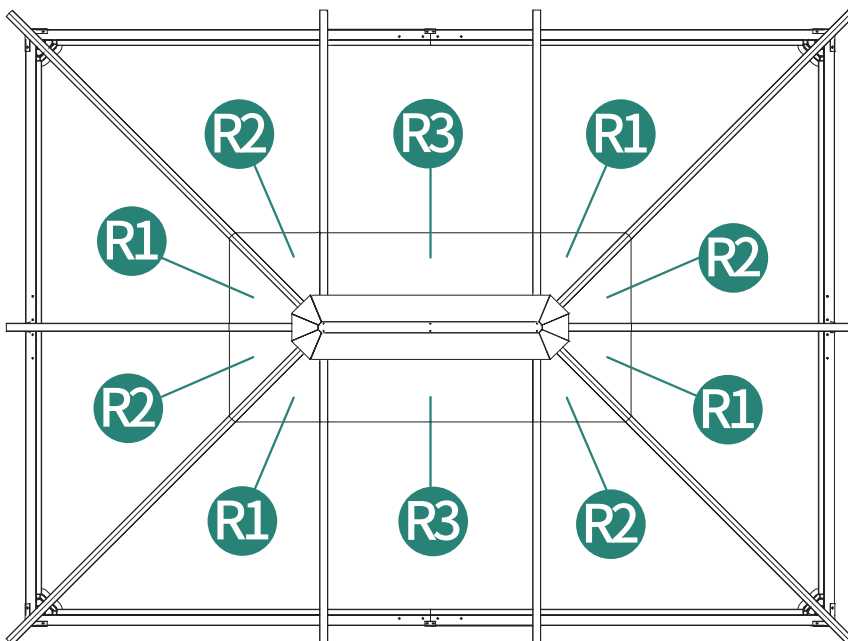
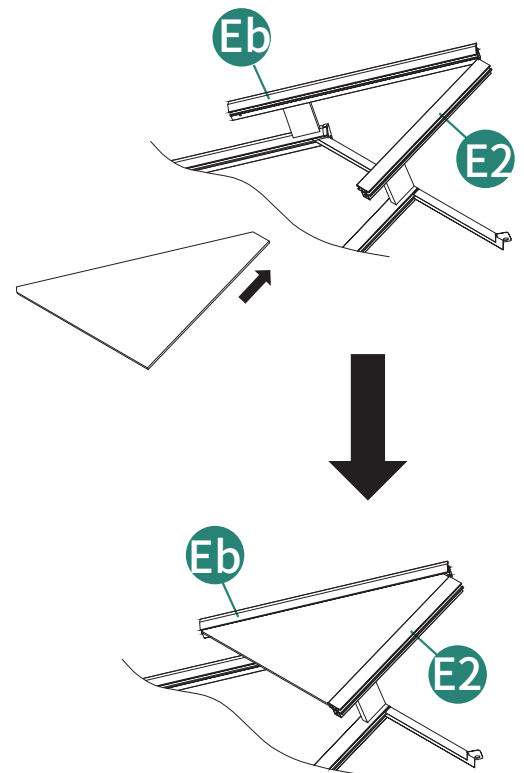
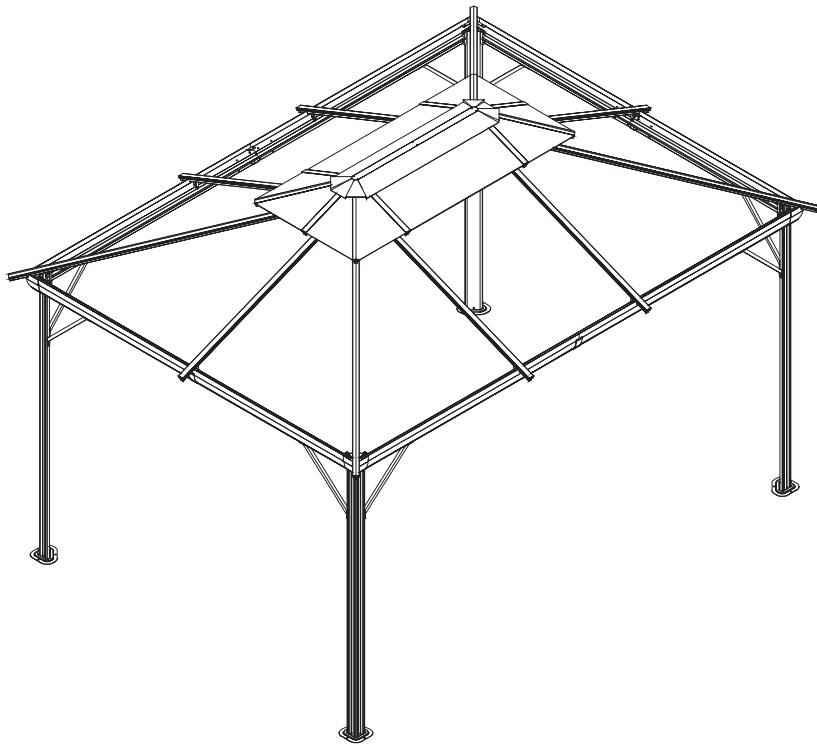

13



! Before installing Parts R1/R2/R3, remove protective films (with side marks) on both the front and back sides. After removal, there will be no mark and minimal difference between the sides. Therefore, pay close attention to directions before removal.

ASSEMBLY INSTRUCTIONS

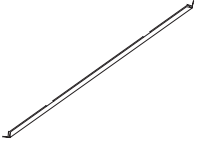
14

-  G3 2pcs
-  G4 2pcs
-  N 4pcs
-  1 10pcs

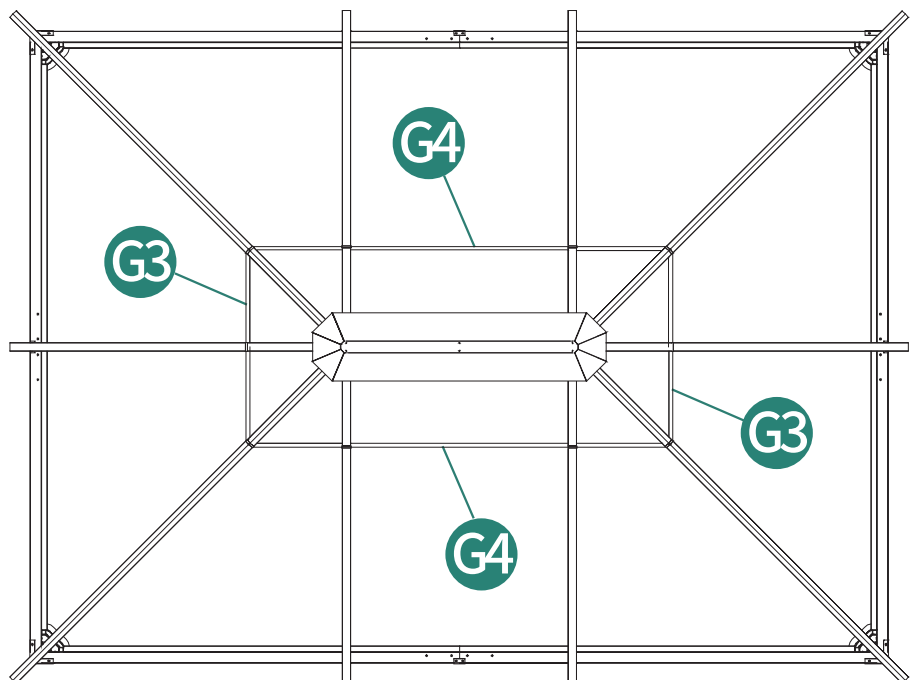
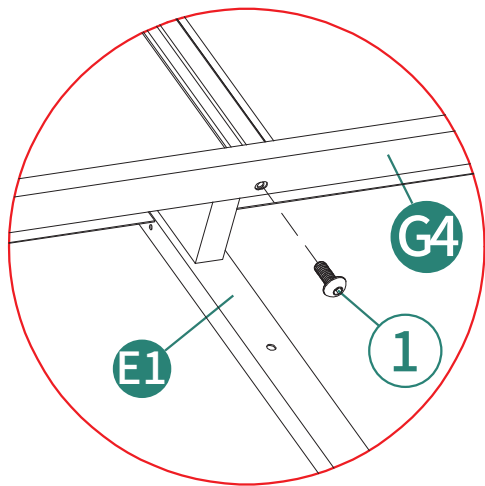
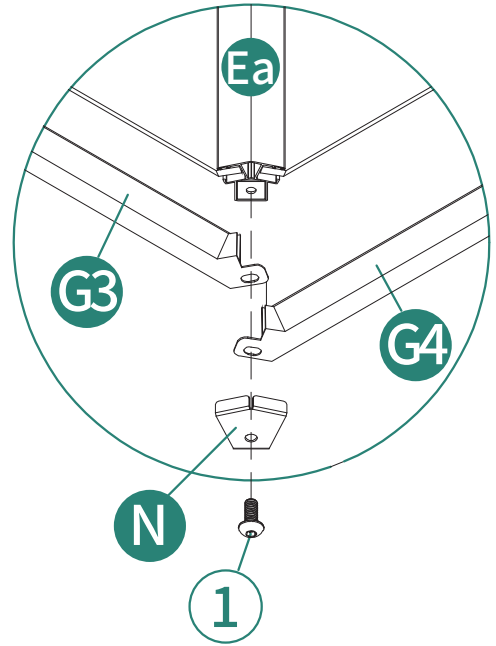
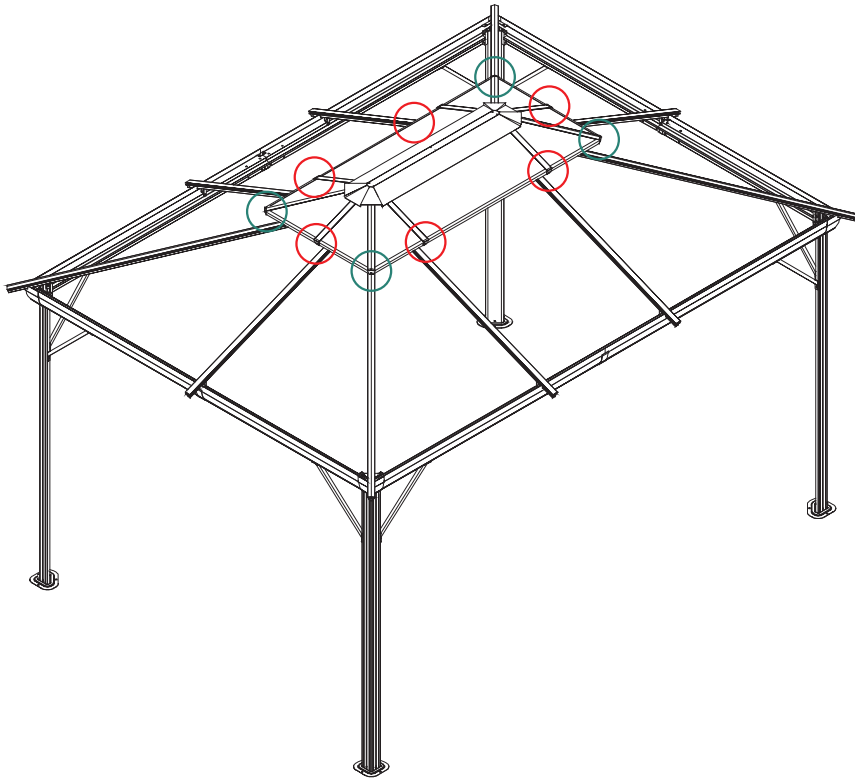

ASSEMBLY INSTRUCTIONS

15

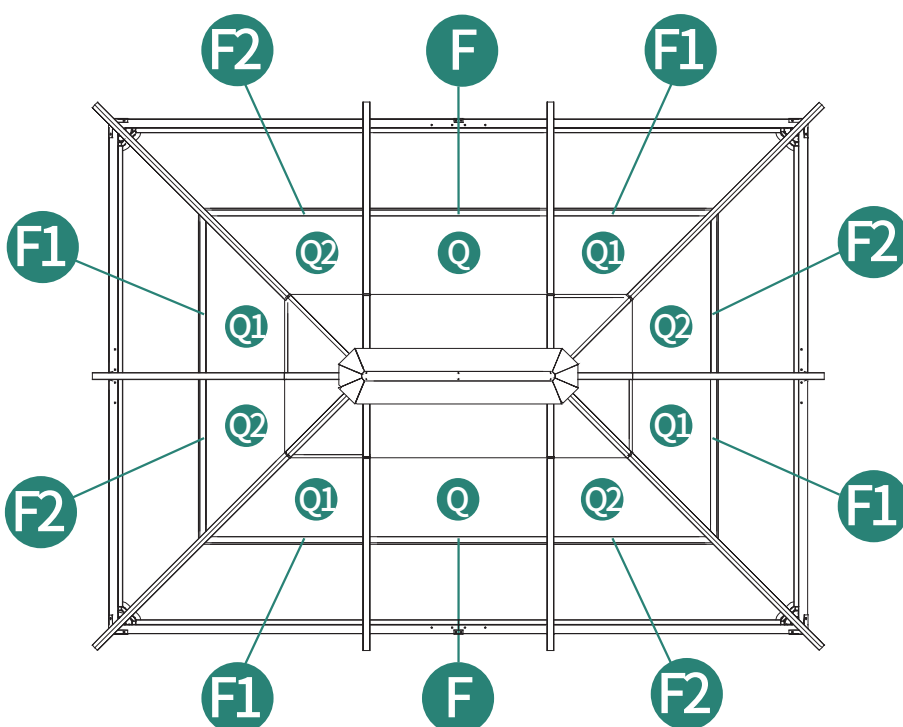
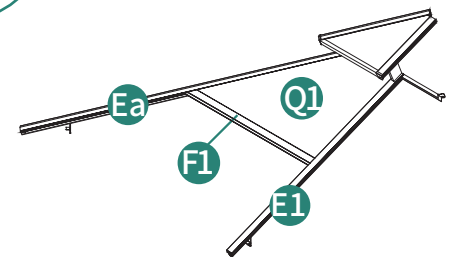
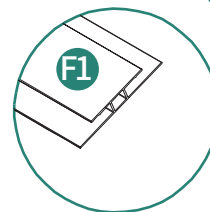
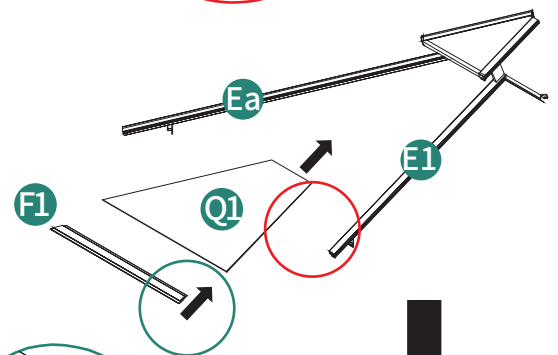
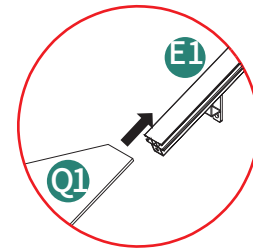
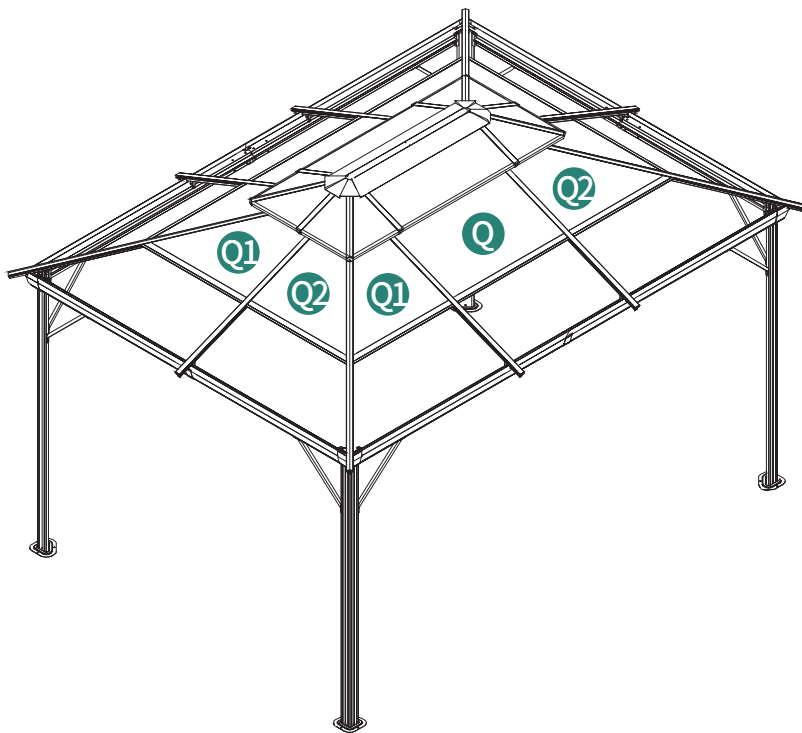
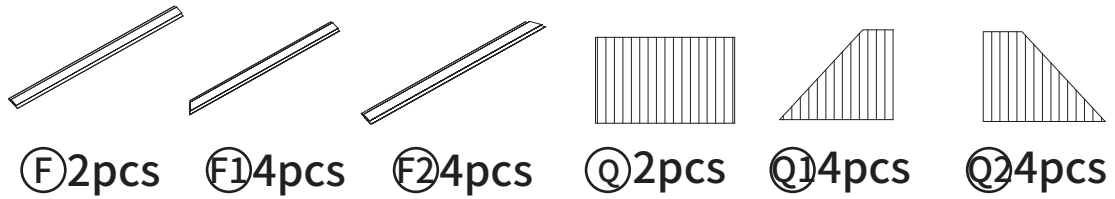

▲ Before installing Parts Q/Q1/Q2, remove protective films (with side marks) on both the front and back sides. After removal, there will be no mark and minimal difference between the sides. Therefore, pay close attention to directions before removal.

ASSEMBLY INSTRUCTIONS

16

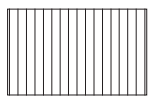

Q2 2pcs

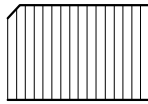

Q3 4pcs

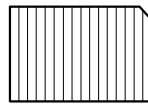

Q4 4pcs



Q5 4pcs



Q6 4pcs

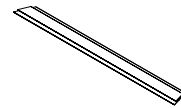

F3 4pcs

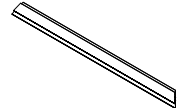



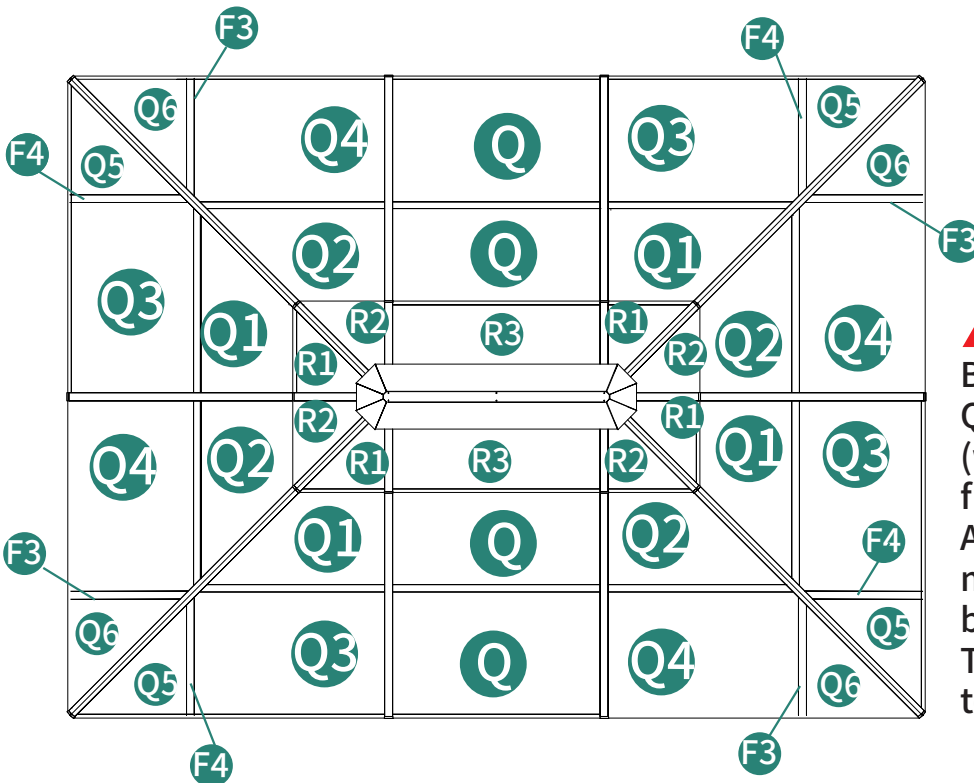
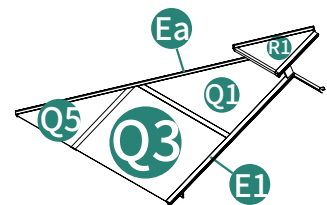
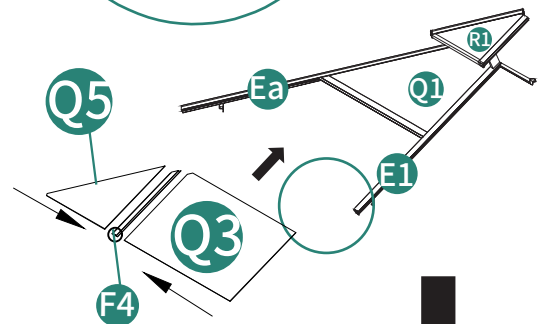
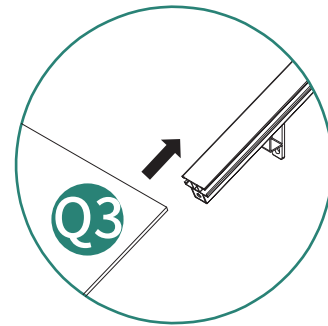
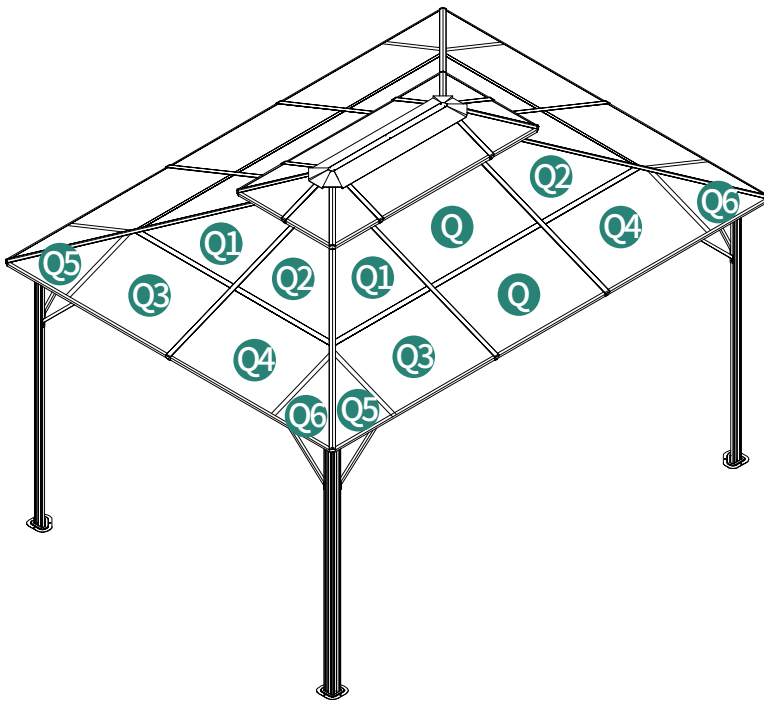

F4 4pcs

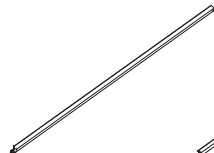
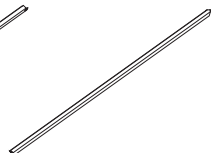

⚠ Before installing Parts Q/Q3/Q4, Q5/Q6 remove protective films (with side marks) on both the front and back sides. After removal, there will be no mark and minimal difference between the sides. Therefore, pay close attention to directions before removal.

ASSEMBLY INSTRUCTIONS

17

-  G2 2pcs
-  G1 4pcs
-  G2 4pcs
-  N 4pcs
-  N1 6pcs
-  1 10pcs

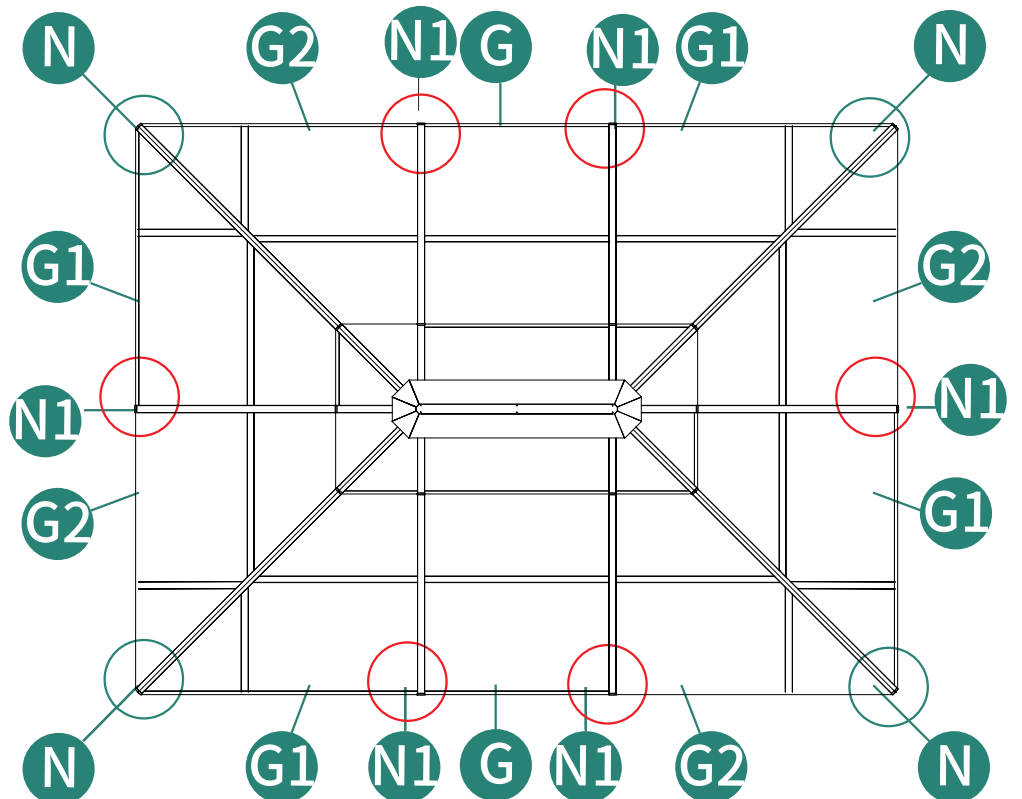
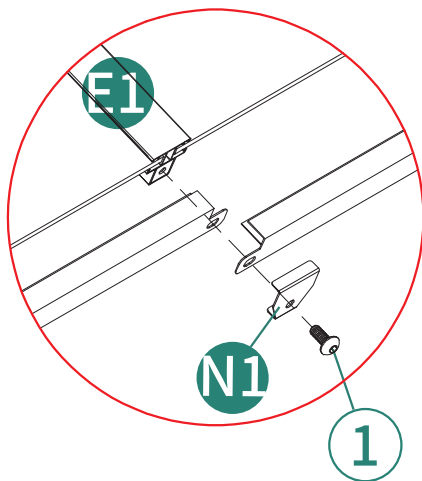
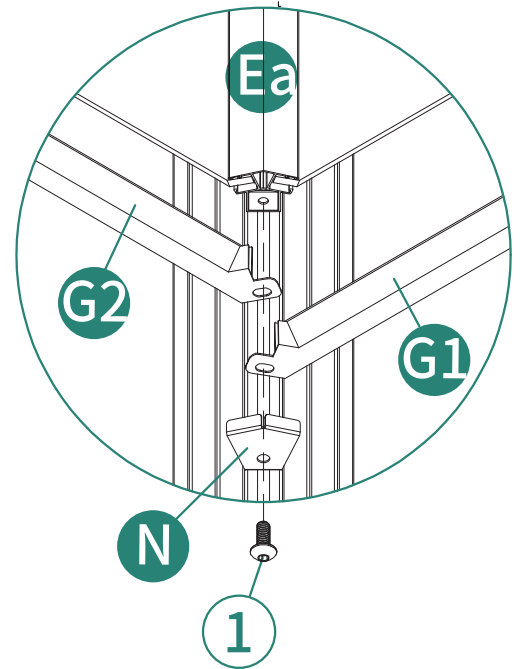
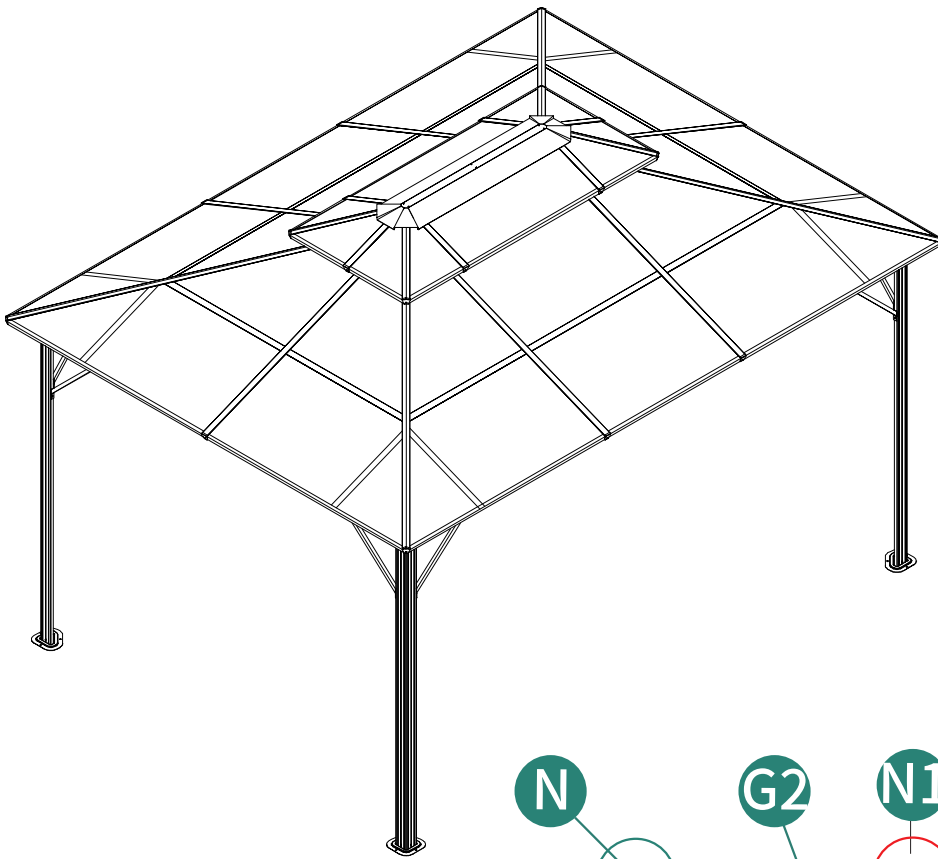

ASSEMBLY INSTRUCTIONS

18



T 4pcs

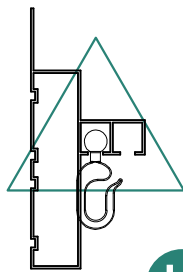
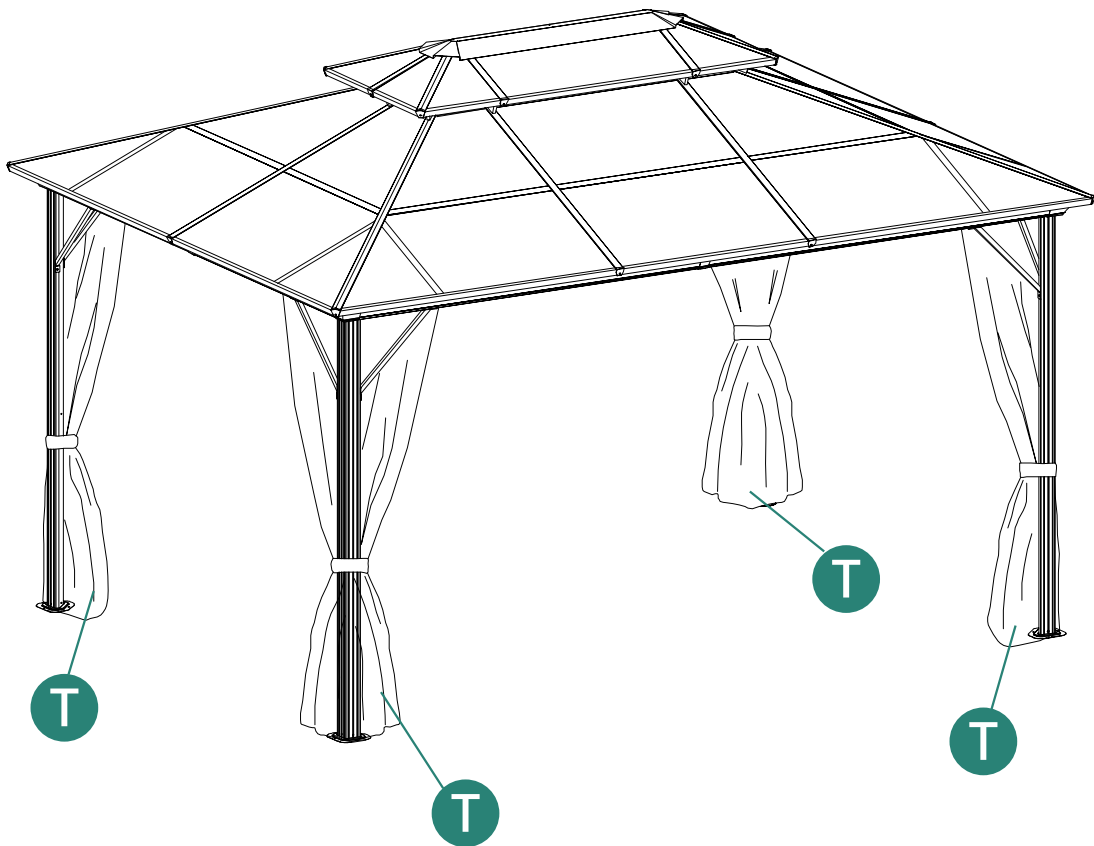

U

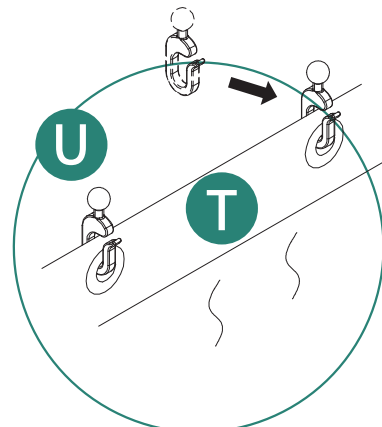

Pay attention to the sidewall curtain's installation position.

ASSEMBLY INSTRUCTIONS

19

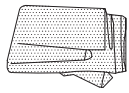

Ⓢ4pcs

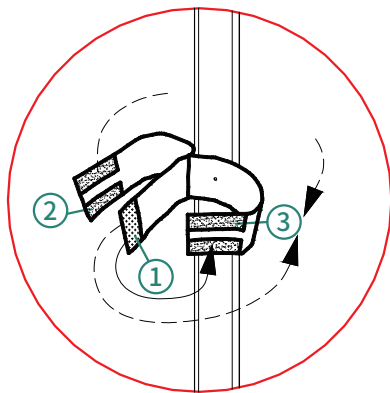
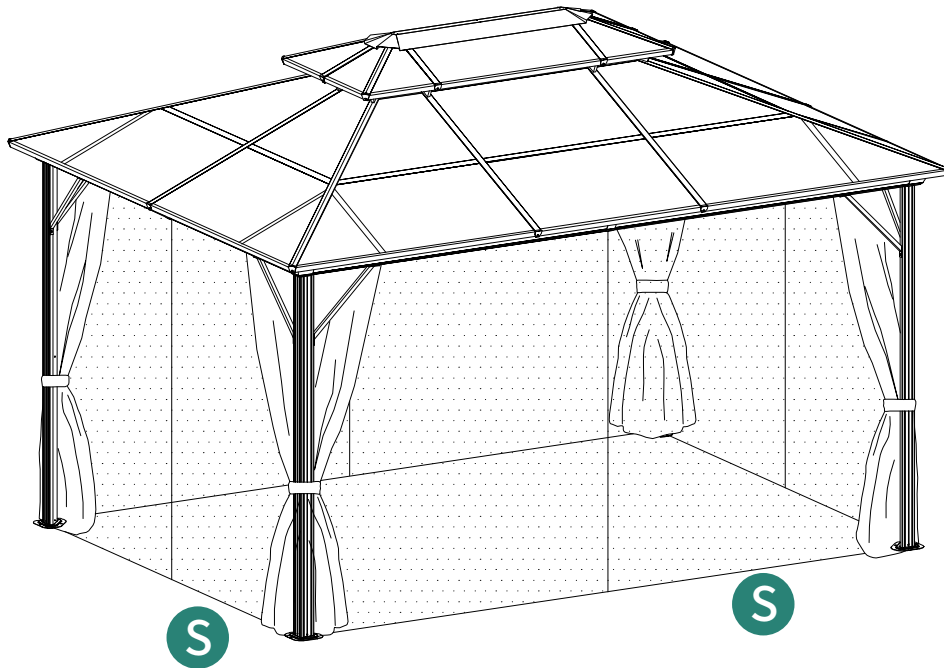

Note:

Attach 1 to 2 to secure parts S (netting) and T (curtains) together.

Attach 1 to 3 to secure the back curtain (T).

Attach 1 to 3 to secure the front netting (S).

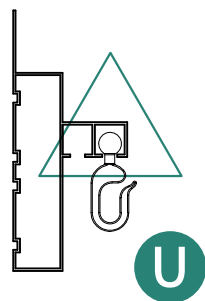

Pay attention to the sidewall netting's installation position.

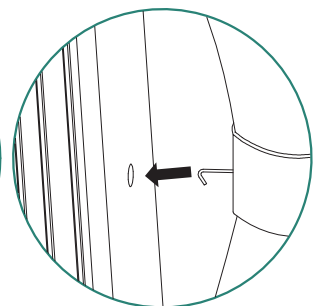
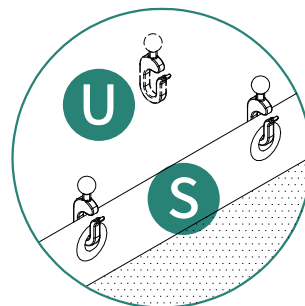

Hang the hook attached to the netting on Part A.

ASSEMBLY INSTRUCTIONS

20



⑧12pcs

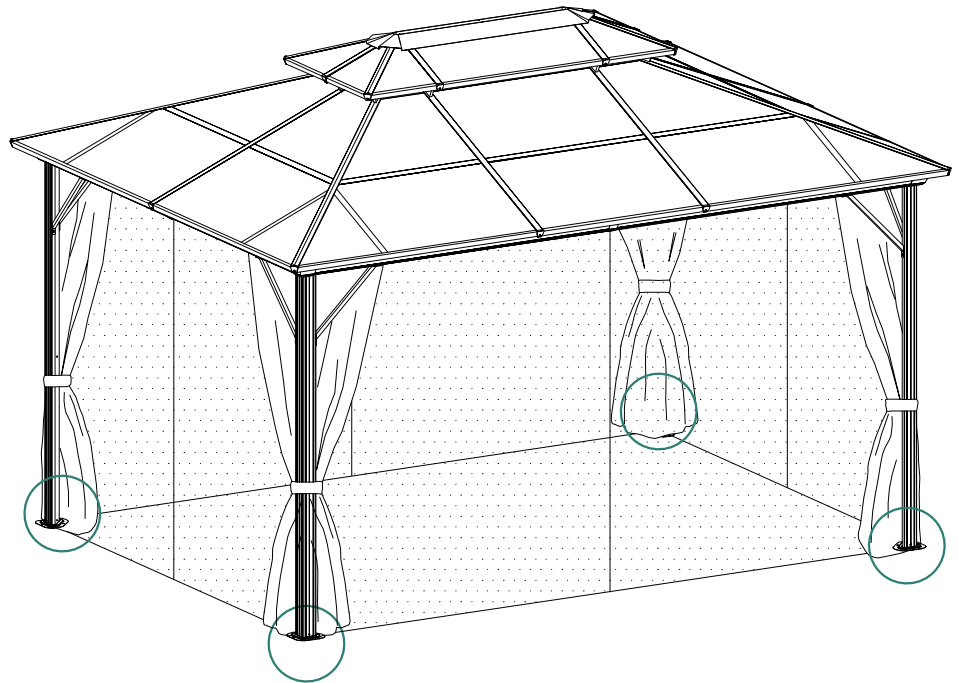

Installation Completed

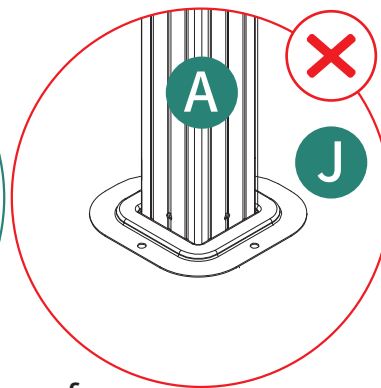
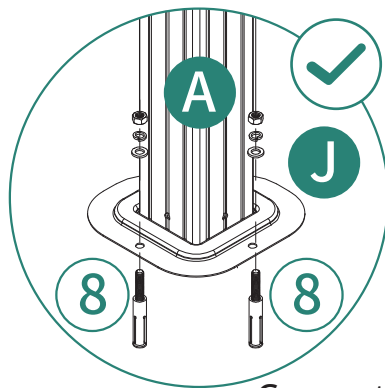

Cement surfaces



To improve wind resistance, **be sure to complete this installation step. If expansion screws or ground nails are not installed, strong winds may topple the gazebo.**

Expansion screws are essential for stability on cement surfaces, All are included in the accessories package.