

A

G



⚠ WARNING

- Please read the instructions carefully before commencing installation.
- Disconnect the power supply at the fuse box before installation.
- Installation must be carried out by a competent person.
- If the wire or flexible cord is damaged, it must only be changed by the manufacturer or qualified personnel in order to avoid risk.
- Clean with a soft dry cloth. Do not use polishing agents, water or abrasive materials when cleaning.

⚠ ATTENTION

- Veuillez lire attentivement les instructions avant de commencer l'installation.
- Débranchez l'alimentation électrique au compteur avant l'installation.
- L'installation doit être effectuée par une personne compétente.
- Si le câble flexible ou fil du luminaire est endommagé, il conviendra de faire appel au fabricant ou encore à une personne qualifiée pour le remplacer et éviter ainsi tout risque fâcheux.
- Nettoyer uniquement avec un chiffon doux et sec. Ne pas utiliser de produits de polissage, d'eau ni de matériaux abrasifs lors.

⚠ WARNUNG

- Bitte lesen Sie die Anleitung sorgfältig, bevor Sie mit der Installation beginnen.
- Trennen Sie vor der Installation die Stromversorgung am Sicherungskasten.
- Die Installation muss durch eine kompetente Person durchgeführt werden.
- Wird das Kabel der Leuchte beschädigt, darf dieses nur durch den Hersteller oder eine entsprechend qualifizierte Person ausgetauscht werden, um eventuelle Risiken zu vermeiden.
- Nur mit einem weichen, trockenen Tuch reinigen. Benutzen Sie bei der Reinigung keine Poliermittel, Wasser oder scheuernden Substanzen.

⚠ ADVERTENCIAS

- Por favor, lea detenidamente las instrucciones antes de comenzar la instalación.
- Desconecte la alimentación eléctrica en la caja de fusibles antes de la instalación.
- La instalación debe ser realizada por una persona cualificada.
- Si el cable flexible o cordón de esta luminaria está dañado, deberá sustituirse exclusivamente por el fabricante o una persona de cualificación equivalente con objeto de evitar cualquier riesgo.
- Limpie únicamente con un paño suave y seco. No utilice agentes abrillantadores, agua ni materiales abrasivos para su limpieza.

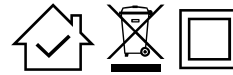



AGO lighting

No. 554, Euljiro 157, Jung-gu 04545
Seoul, South Korea

info@agolighting.com
www.agolighting.com

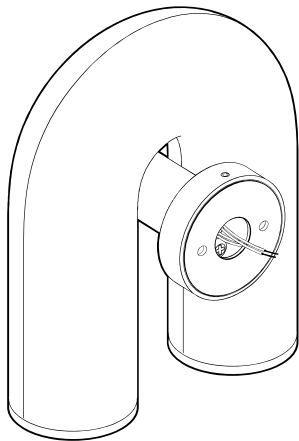
CONTENTS / CONTENIDO / CONTENU / INHALT

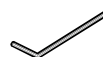

 Cord connector

 Hex key

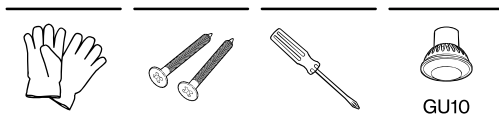

GU10

1.

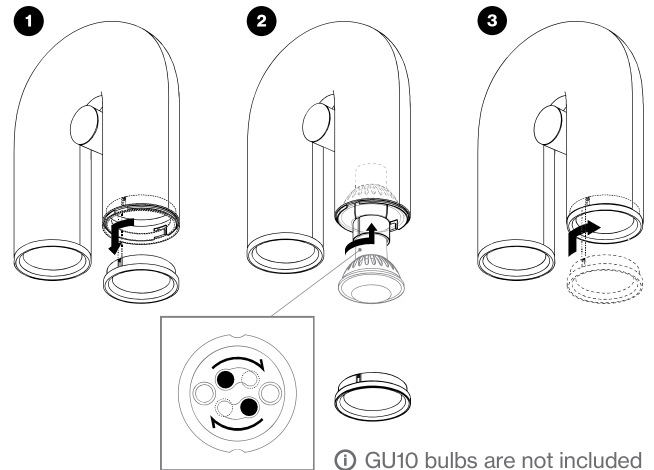

2.

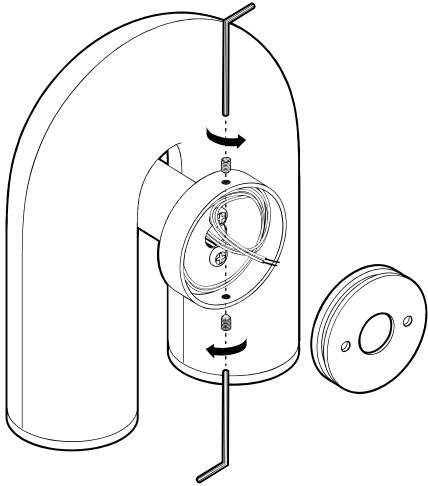

3.

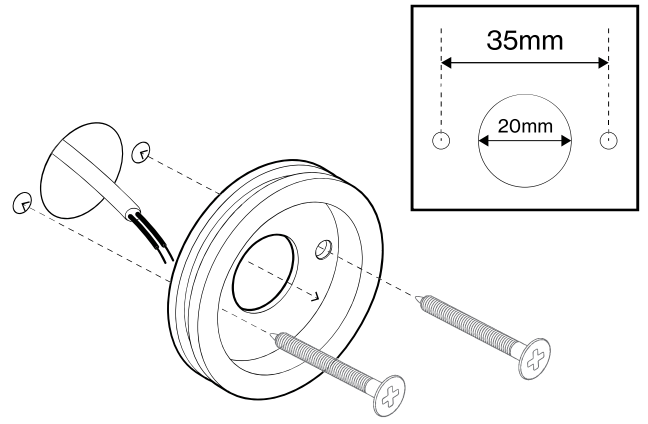

i Screws are not included

4.

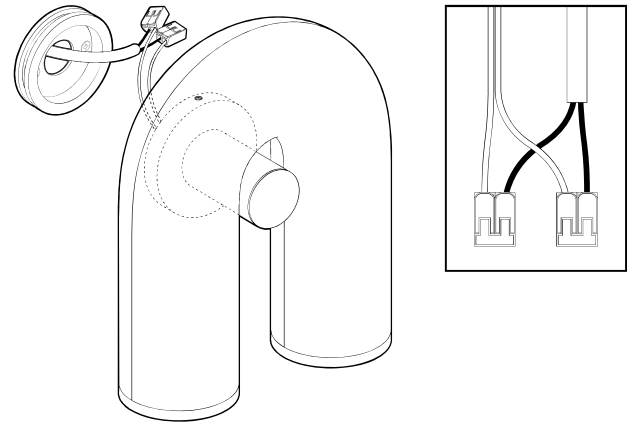

5.

