

# *the* EIKON BASIC

*designed by Julia Jessen & Niklas Jessen | 2013*



*Eikon Basic „Amber, Poppy Red and Wax“ with oak wood*

*Eikon Basic* is a minimalist lamp made of certified wood and a coloured metal lampshade. The wooden base and the coloured shade are a perfect match for many home and interior design applications.

The light has a clean line that gives it a pure and contemporary look with a subtle reminder of the industrial age. The magnetic connecting system allows the lampshade to be easily changed for another color or shape of the Eikon collection.

# *the* EIKON BASIC

## DIMENSIONS

26 cm x 35 cm

## WEIGHT

2,2 kg

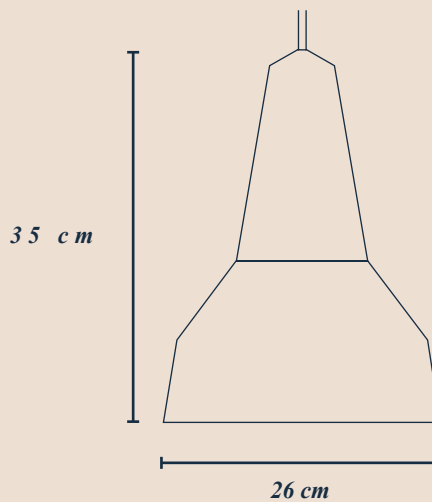

## PRODUCTION PROCESSE

Eikon is made of certified wood and produced in Germany.

## TYPE | ENVIRONMENT

Pendant lamp | indoor

## MATERIAL SOCKET



Ash



Oak

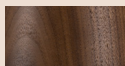

Walnut



German  
Design Award

SPECIAL  
MENTION 2015

## LAMPESHADRE MATERIAL

Powder coated steel

Colors:



Pistache



Poppy Red



Wax



True Blue



Amber

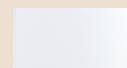

White

*the* EIKON BASIC is available in two other shapes (SHELL | CIRCUS).

# the EIKON BASIC

## CORD

Textile cord | length: 2.5 m

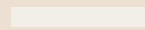

Cream

## LIGHT SOURCE & ENERGY EFFICIENCY

E27 | Bulb is not included

Compatible with bulbs of the energy classes: A++ - E

Suggested lightbulb:



LED - 11 W



H - 40 W



I - 60 W

## SPECIFICATIONS



IP20

## VOLTAGE

220V - 240V | 50Hz

Other cords (voltage) on request.

## CANOPY

Cable Cup covering included | white or black | 15,8 cm x 6 cm

Made out of soft material (PVC). The cup can be easily folded over and fits tight to the ceiling.

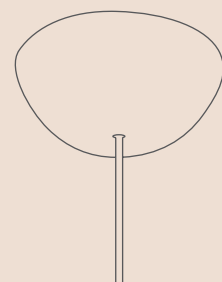
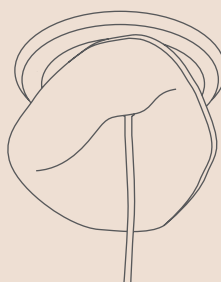
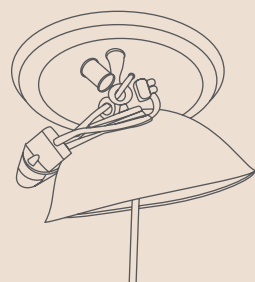

## MAINTENANCE

Wipe off dust with feather duster. To remove fresh stains wipe with a slightly moist cloth. Always switch off the electricity before cleaning.