

Durin

INSTALLATION AND OWNER'S MANUAL

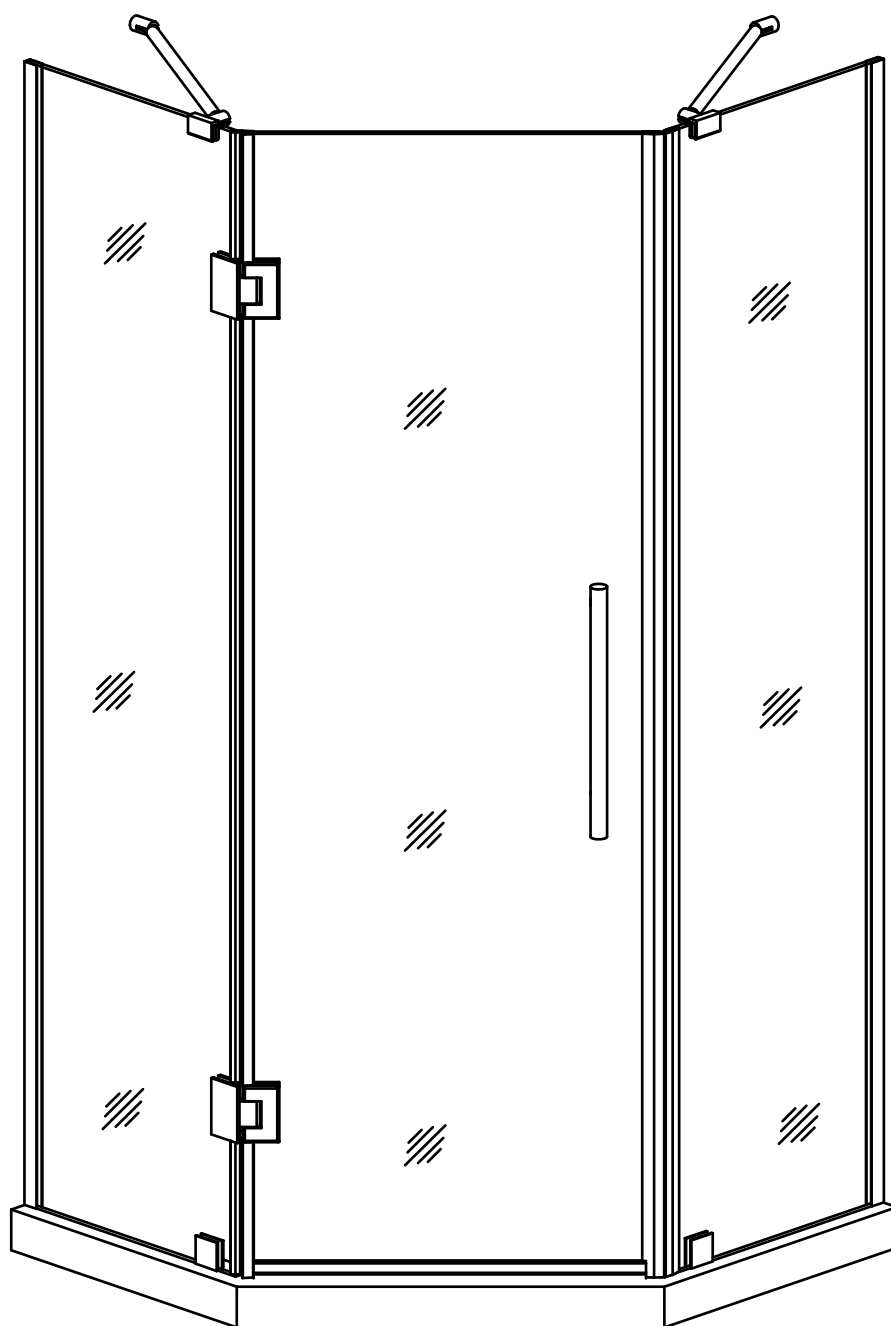

Shower Door Model Number: TAMPA TU-SK-966-38-(C/B)

Please carefully read these instructions before you begin to install the products.

Before you start

Thank you for purchasing your shower door. We hope that it will provide you with years of satisfying use and enjoyment.

Please read this manual carefully because it contains information and instructions about the proper installation of the unit. If you do not follow certain conditions of installation and maintenance, your warranty may be affected.

1. NOTE: You should consult your local building codes with questions on installation compliance standards. Plumbing and building codes vary by location.

2. Before installation, inspect installation surfaces or level and have to the strength to support the heavy weight of this shower door assembly. This Shower Door should only be installed using the connection point to the studs or to pre-installed 2x6 wood reinforcements behind the wall.

3. This Shower Doors assembly is very heavy and requires professional installation.

Shower door's feature:

- Tempered Safety Glass
- High quality hardware
- Easy maintenance durable fiberglass reinforced acrylic

WARNING: The Shower door is designed to be used with tiled walls. If you are using a pre-made Acrylic/ABS/FRP shower stall that will be thicker than average plus tile, then you must consider the offset of the pre-made panel thickness. If applicable, the shower tray has 1/4" of tolerance for the oversized wall thickness.

Installation Guide

Please read and follow the installation instructions and guidelines in this section. Failure to follow the recommended instructions and installation techniques may lead to possible damage to the unit or the surrounding area. This can affect warranty claims.

ATTENTION: This unit requires assembly. A minimum of two people are required for assembly, as several of the sections can be large and unstable until assembled.

You will need the following tools:

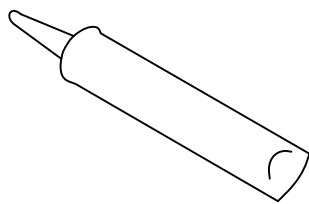

Caulk

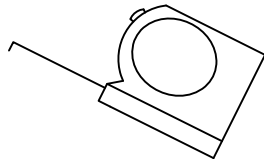

Tape Measure

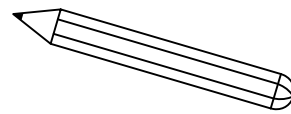

Pencil

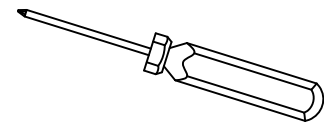

Phillips Screwdriver

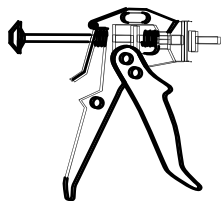

Caulk Gun



Level

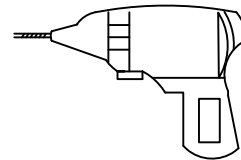

Electric Drill

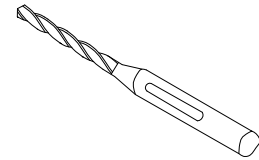

Drill bit (Ø⁵/₁₆")

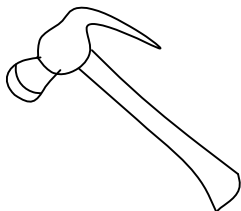

Hammer

Locate the accessory box and remove the individual screw and hardware packages. Lay them out in sequential order to aid in completing the rest of the installation.

Detailed Diagrams of Shower Enclosure Components

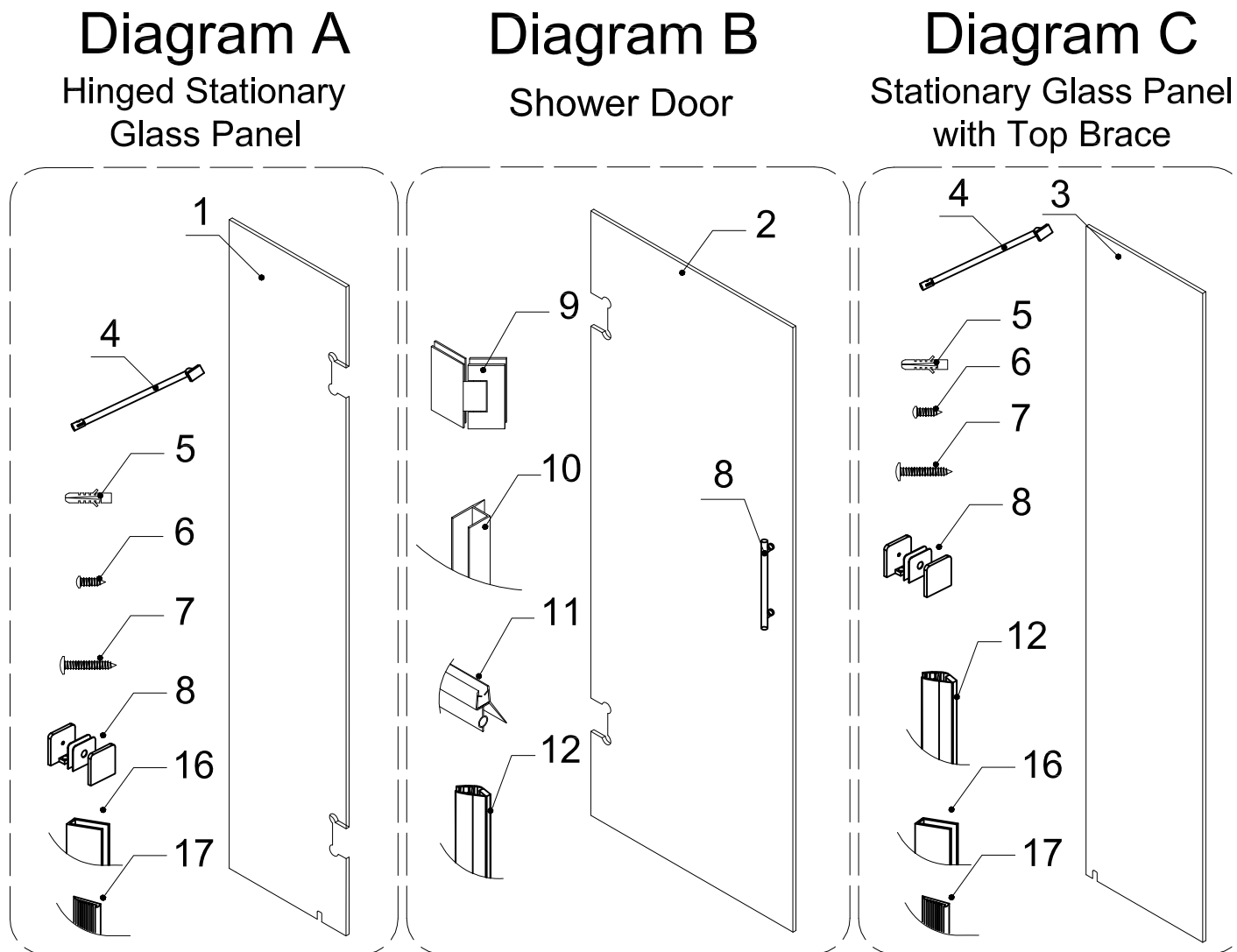

Diagram A

01	Hinged Stationary glass panel	1pc	06	M5 X 60 screw	1pcs
04	Support bar	1pc	07	M4 X 60 screw	4pcs
05	Wall anchor	5pcs	08	Glass clamp	1pcs
16	Wall channel	1pcs	17	One side seal	1pcs

Diagram B

02	Glass door	1pc	10	Side strip seal (3 sections to cut)	1pc
08	Handle	1pc	11	Bottom anti-water strip seal	1pc
09	Hinge	2pcs	12	Magnetic strip seal	1pc

Diagram C

03	Stationary glass panel	1pc	07	M4 X60 screw	4pcs
04	Support bar	1pc	08	Glass clamp	1pcs
05	Wall anchor	5pcs	12	Magnetic strip seal	1pc
06	M5 X 60 screw	1pc	16	Wall channel	1pcs
			17	One side seal	1pcs

SUPPLIED PARTS

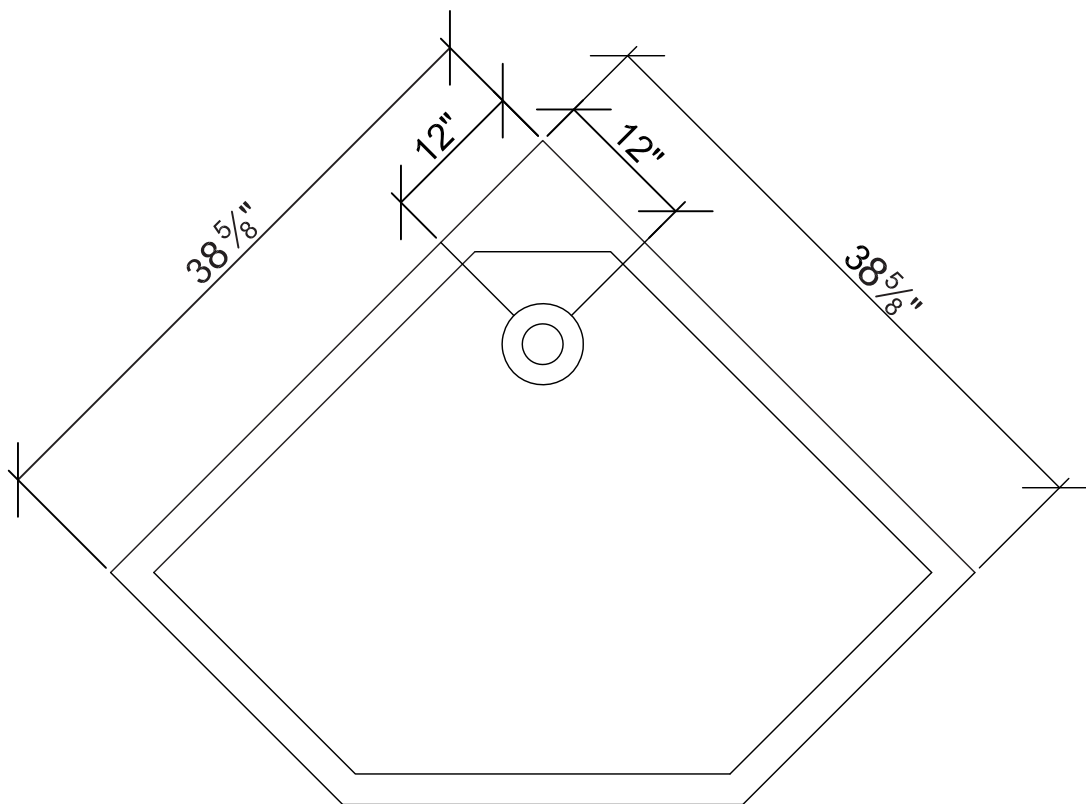
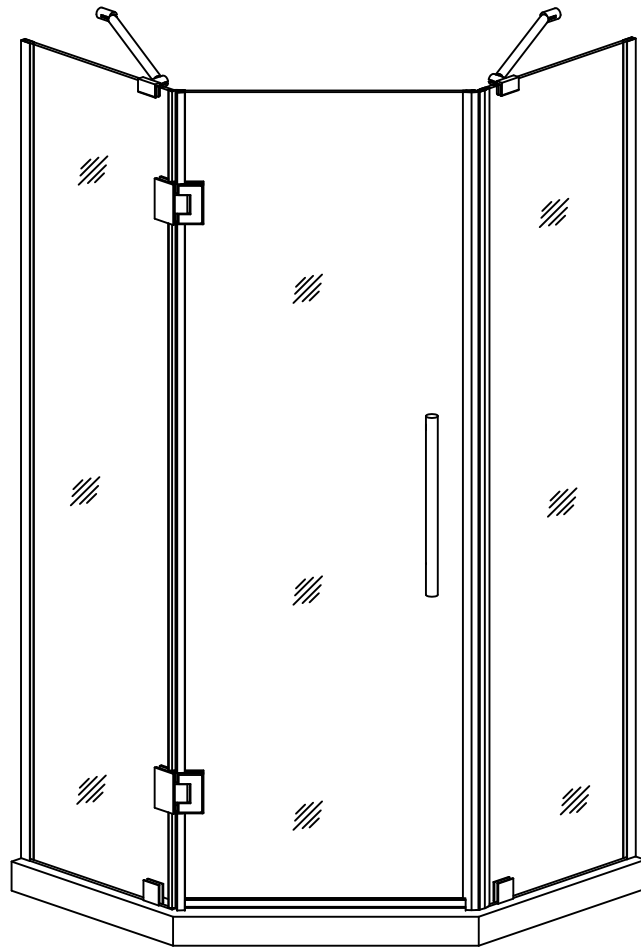

Preparation of base for installation of shower tray

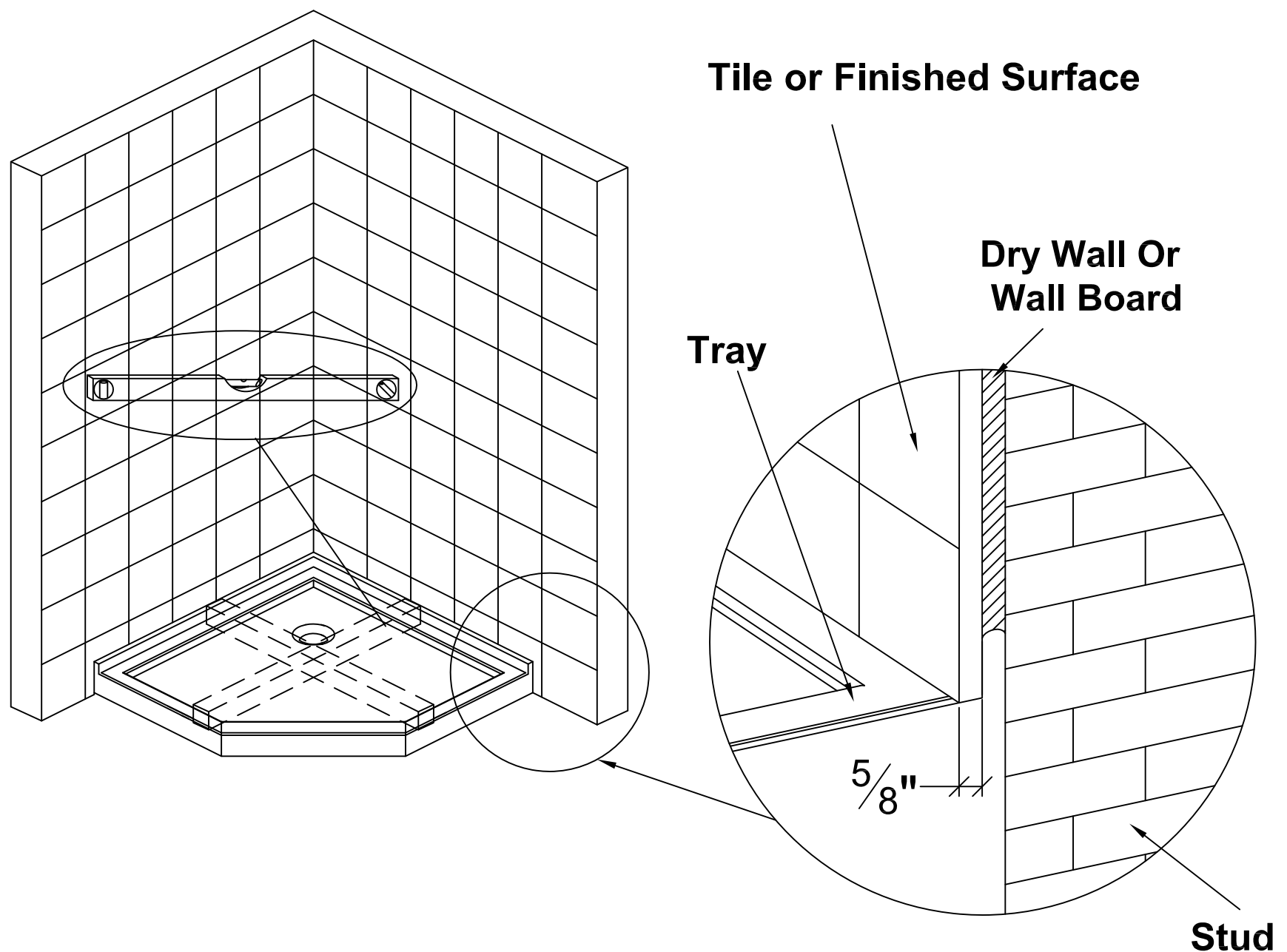

WARNING: THE Aston shower door and tray are designed to be used with tile walls. If you are using a pre-made Acrylic/ABS/FRP shower stall that will be thicker than average wall board plus tile then you must consider the offset of the pre-made panel. The shower tray has 1/4" of tolerance for over sized wall thickness.

The shower tray needs to sit on a flat level base for proper support. Ensure that the area for the shower tray is properly prepared for installation.

Using the drawing provided, place the floor drain in the proper location so that the shower tray drain and the floor drain are in line after final installation.

Place the shower tray in the final installation position line up the drain holes and check for level. If not level make adjustments to the floor at this time.

Shower Enclosure Assembly and Installation

NOTE: Please use parts from Diagram "A" and Diagram "B" or "C" (depends on your model style) for the Shower enclosure assembly and installation.

ATTENTION: A minimum of two people are required for the next assembly steps.

1. Remove pre-installed screws from pre-assembled Glass clamps (08).

Align the Glass Clamps (08) with notches in the Hinged Stationary glass (01) and install Glass clamps (08) to Stationary glass (01).

Noted: Smooth flat surface of Glass clamp (08) should be installed on outside of glass door.

Insert the Hinged Stationary glass (01) into the Wall channel(16).

See Figure 1 for details.

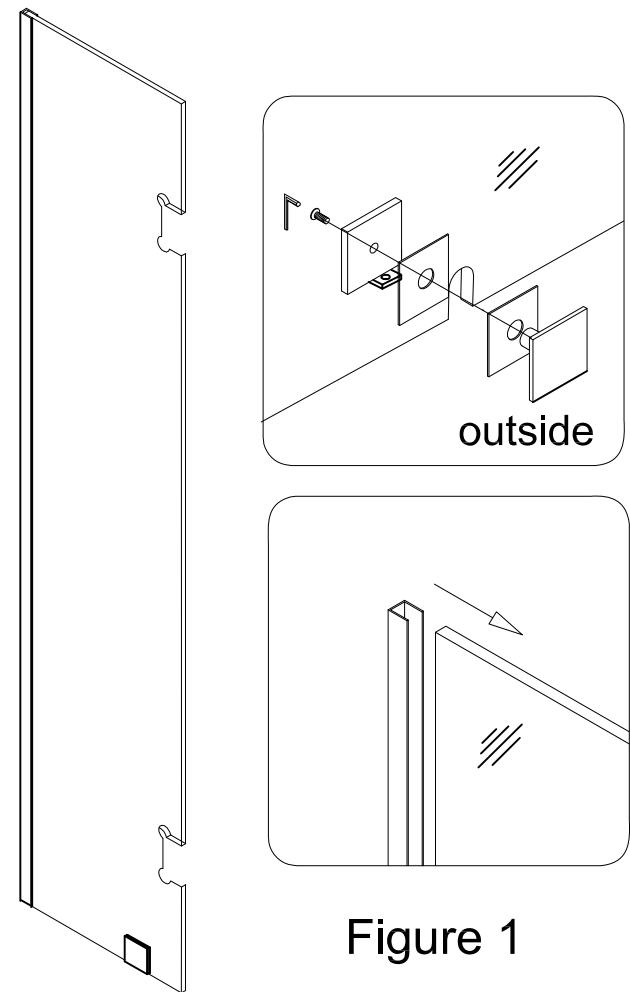

2. Remove pre-installed screws from pre-assembled Glass clamps (08).

Align the Glass Clamps (08) with notches in the Stationary glass (03) and install Glass clamps (08) to Stationary glass (03).

Noted: Smooth flat surface of Glass clamp (08) should be installed on outside of glass door.

Insert the Stationary glass (03) into the Wall channel(16).

See Figure 2 for details.

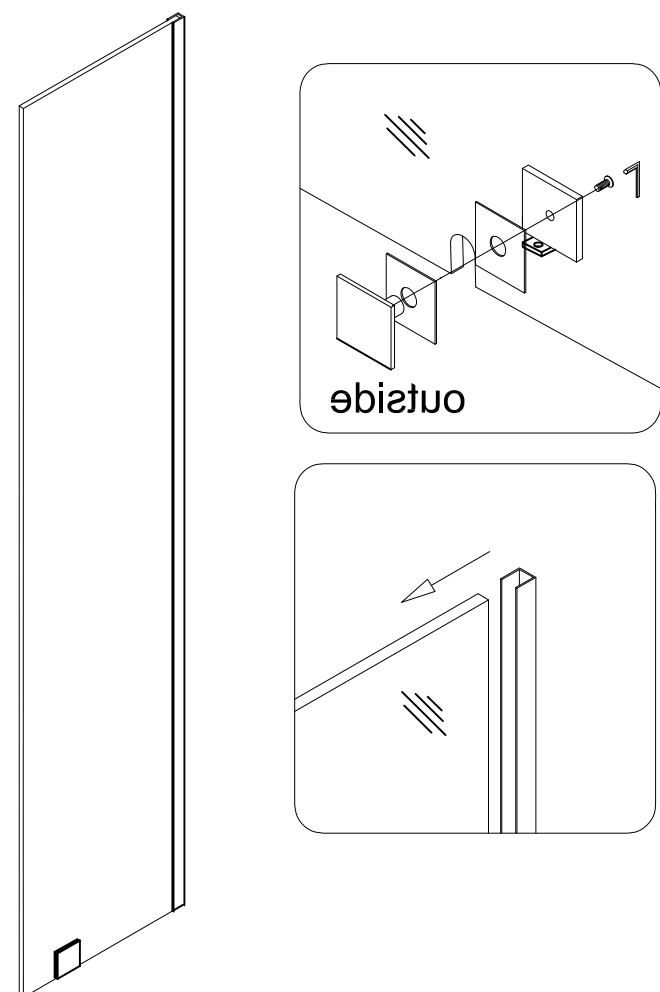

3. Carefully position the Stationary glass panels (01) and (03) against the shower wall aligning the outside edge of Stationary glass panels (01) and (03) with marked dimensions from earlier step. Check with level the plumb Stationary glass panels (01) and (03).

Note: The Stationary glass panels (01) and (03) should be vertical and in plumb.

Note: The unit shown in figure 4 illustration is showing a left hand hinge assembly. If you need a right hand hinge assembly install the Hinged stationary glass panel to the right side of shower opening.

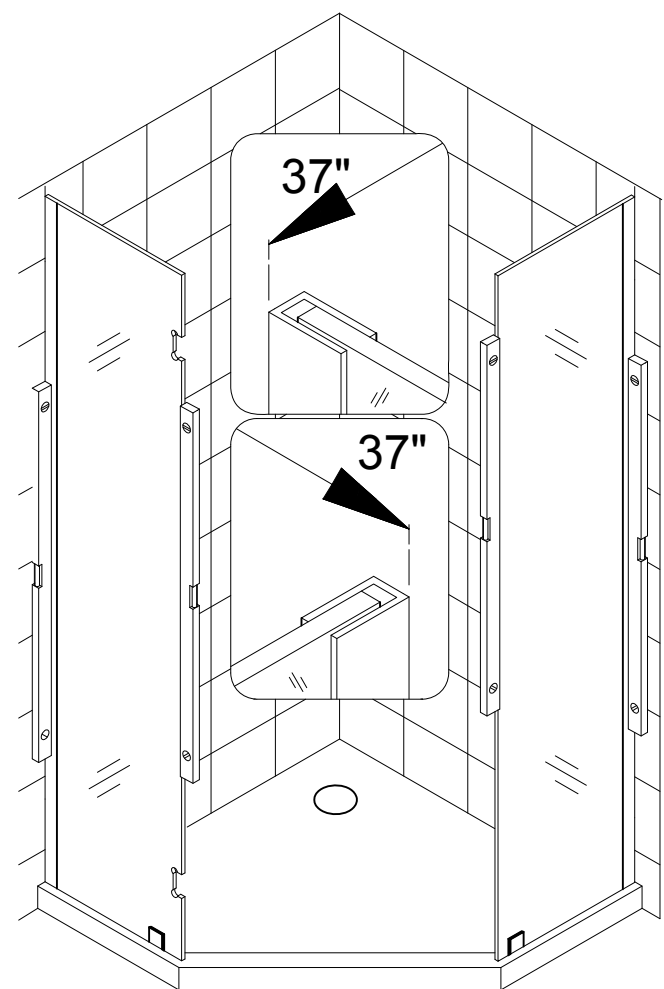

Figure 3

See Figure 3 for details.

4. Mark the position of the the Glass clamps (08) on the shower wall and shower floor from the inside shower.

See Figure 4 for details.

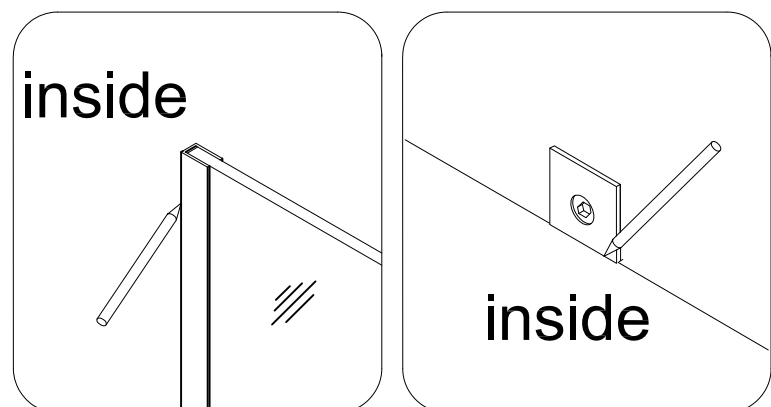

Figure 4

5. Carefully place the Stationary glass panels (01) and (03) aside.

Remove the Glass clamps (08) from the Stationary glass panels (01) and (03). Next position and align the Glass clamps (08) with marked location on shower wall and shower floor. Mark the drill hole locations for mounting the Glass clamps (08) to shower wall and shower floor.

See Figure 5 for details.

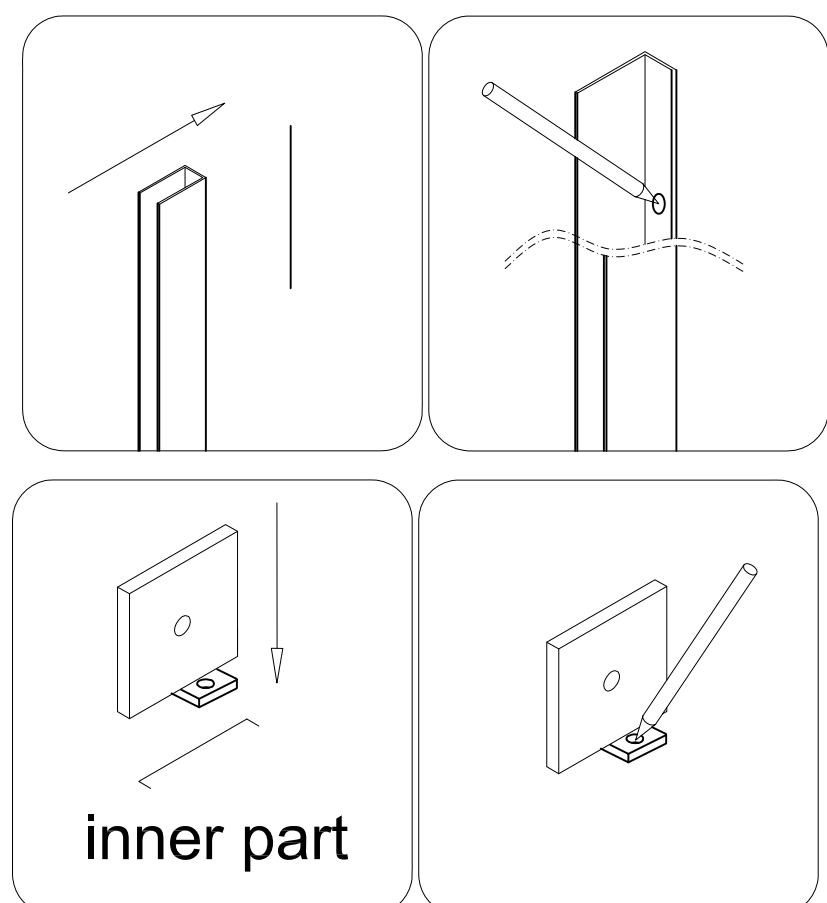

Figure 5

6. Using the appropriate drill bit for your wall surface drill each hole location with a 5/16" diameter drill bit.

Using the appropriate drill bit for your floor surface drill hole location with an 1/8" diameter drill bit for Aston shower base, use a 5/16" diameter drill bit for other surfaces and plastic wall anchor.

See Figure 6 for details.

NOTE: If your surface is prone to cracking or chipping then it is recommended that you pilot drill first using a smaller drill bit, and then step up to the final size.

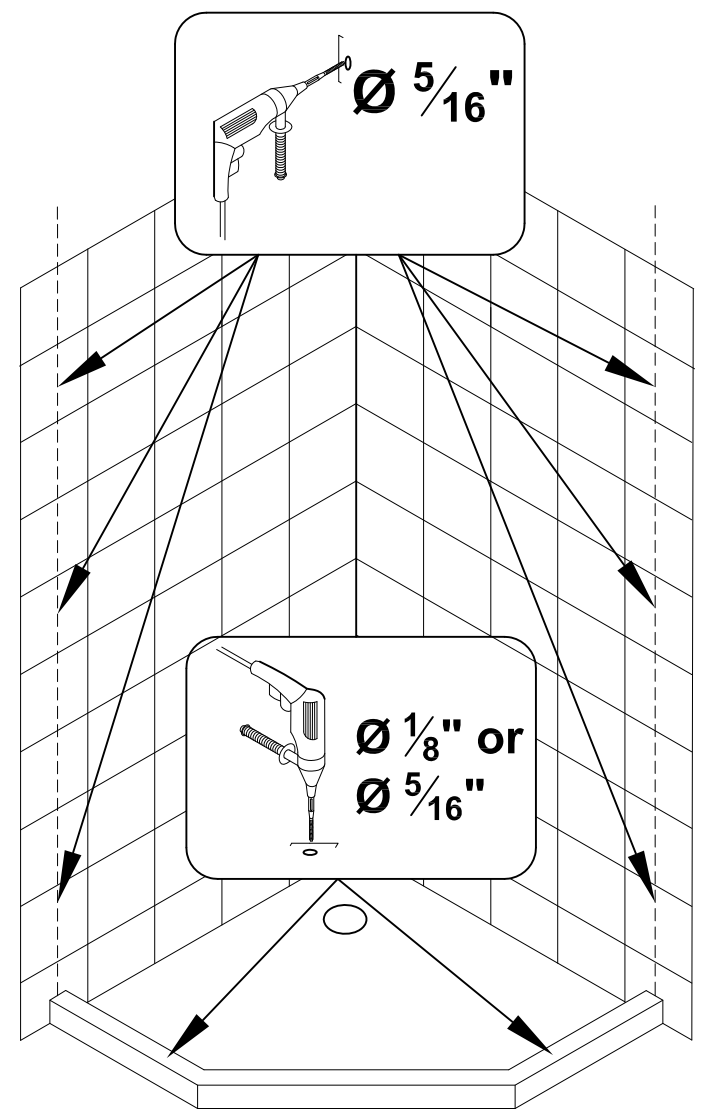

Figure 6

7. Install the plastic Wall anchors (05) provided into the drilled holes on wall.

See Figure 7 for details.

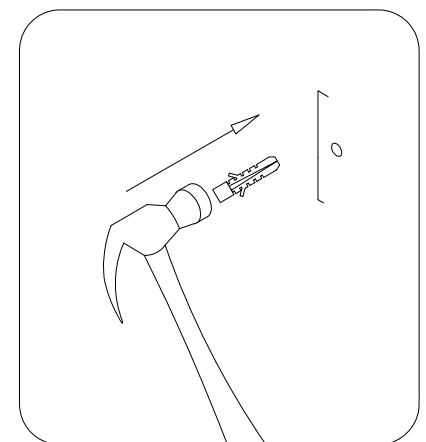

Figure 7

8. Install the Wall channel (16) to shower wall using M4x60 screws.

Install the Glass clamp (08) to shower base using M4x60 screws.

See Figure 8 for details.

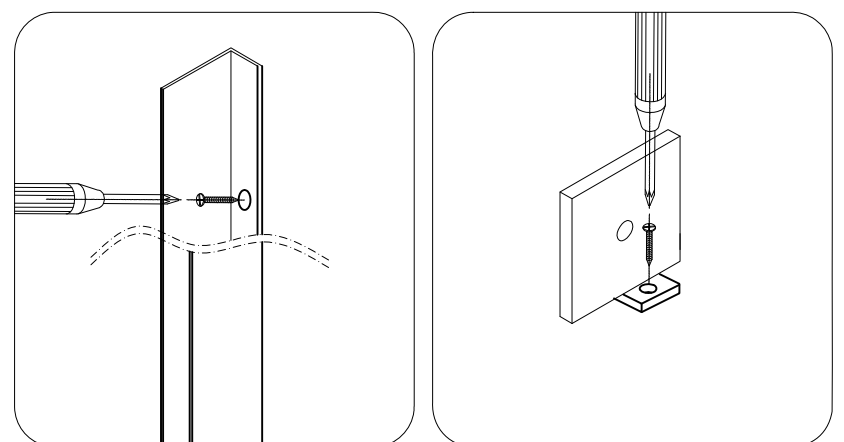

Figure 8

9. Place the Return glass panel (18) into the Wall channel (16) and install glass clamp (13) to Return glass panel (18).

See Figure 9 for details.

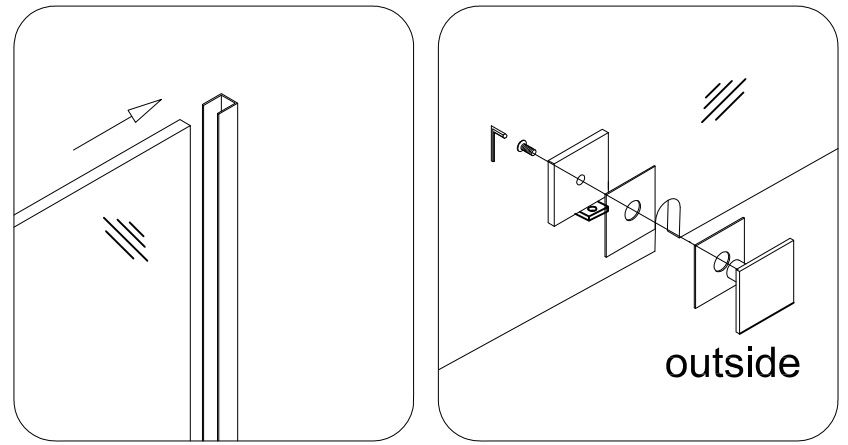

Figure 9

10. Install Wall channel seal (17) to Return glass panel (18).

Spray soapy water on the glass near the Wall channel (10). Then insert the Wall channel seal (21) on the outside of Return glass panel as shown in figure (18). Start from the bottom of Wall channel and work your way up, any extra Wall channel seal remaining at top of Wall channel can be cut off with scissors. Taping the wall channel seal to the top of wall channel can be helpful during this process.

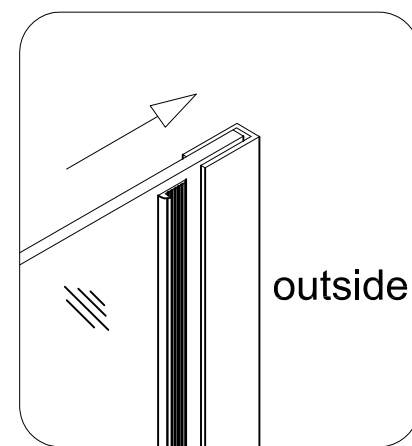
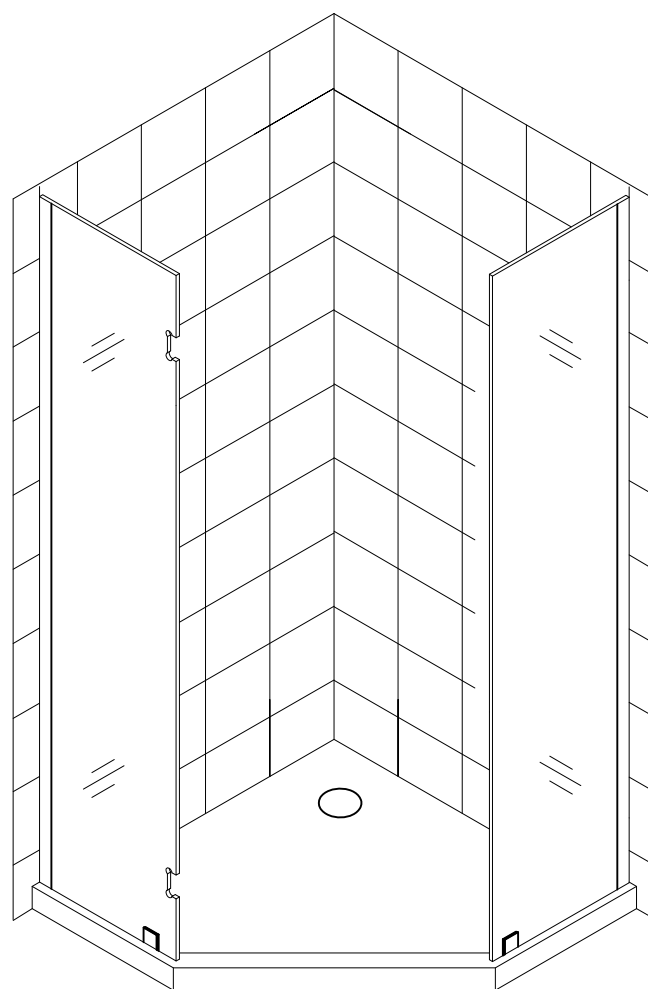

Figure 10

See Figure 10 for details.



11. Press the Magnetic strips (12) onto the vertical edge of the Glass Door (02) and Stationary Glass Panel (03).

See Figure 11 for details.

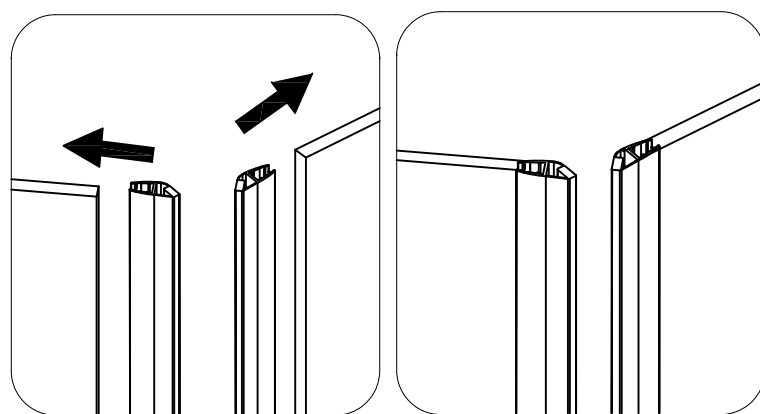

Figure 11

12. Attach the Hinges (09) to the Hinged stationary glass (01), Smooth flat surface of Hinges (09) should be installed on outside of stationary glass (01).

Place a piece of flat timber (1/2" thick) on the threshold or shower base.

Carefully position Glass door (02) on the flat timber and attach shower door to hinges.

Level up the Glass door next to the Hinged stationary glass and fasten the hinges on the Glass door.

If needed, adjust the position of the glass to make sure the Magnetic strips (12) are tight from top to bottom.

See Figure 12 for details.

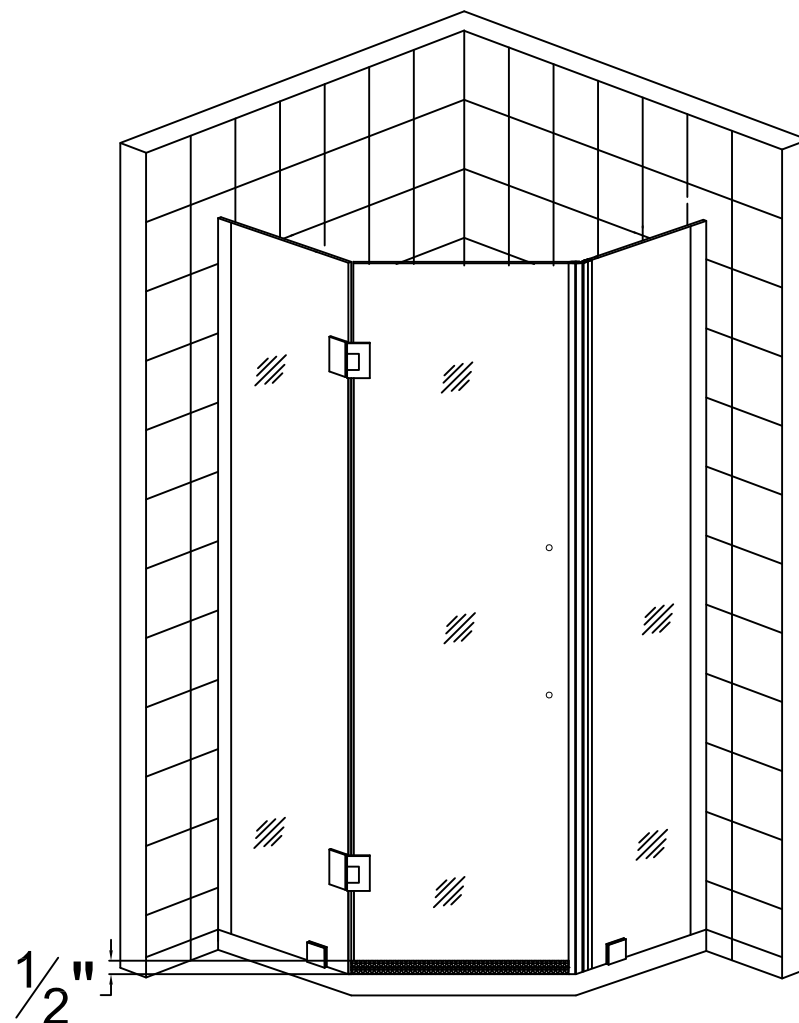
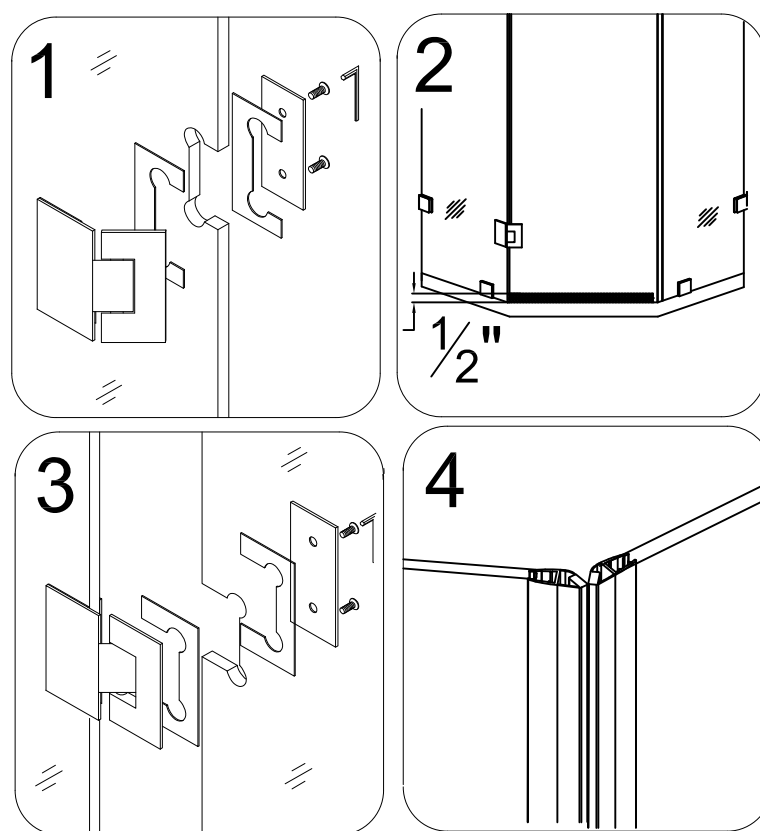

Figure 12

13. Marks on the Side Strip (10) at $8 \frac{1}{16}$ " ,
 $48 \frac{3}{8}$ " and $8 \frac{1}{2}$ ".

Carefully cut the seal at the appropriate marks, then install the individual seals on the appropriate sections of glass door:

- from the top edge of glass door to upper body of the top hinge: $8 \frac{1}{16}$ "
- from the lower body of upper hinge to the upper body of the bottom hinge: $48 \frac{3}{8}$ "
- from the lower body of bottom hinge to $\frac{1}{16}$ " above the shower base: $8 \frac{1}{2}$ "

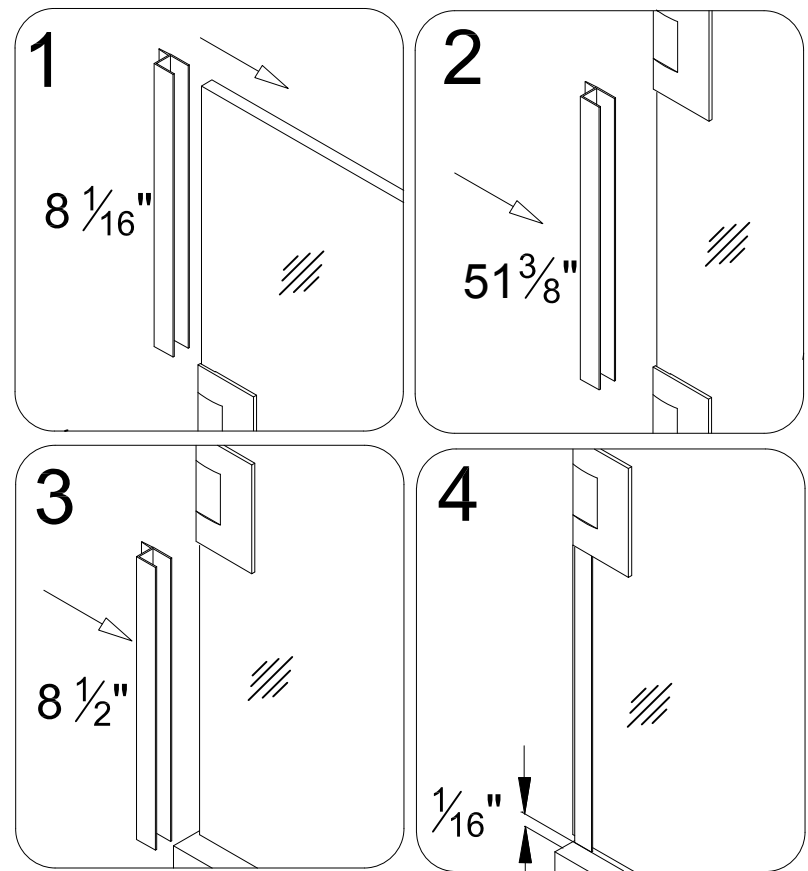

Figure 13

Remove the timber plate, fully open the glass door and press the cut strips on the vertical edge of the glass door.

See Figure 13 for details.

14. Measure the bottom of the Glass door (02) from the Side strip (10) to the vertical edge of Magnetic strip (12).

Cut the Bottom anti-water strip (11) to the size of measurement and press onto bottom edge of glass door.

See Figure 14 for details.

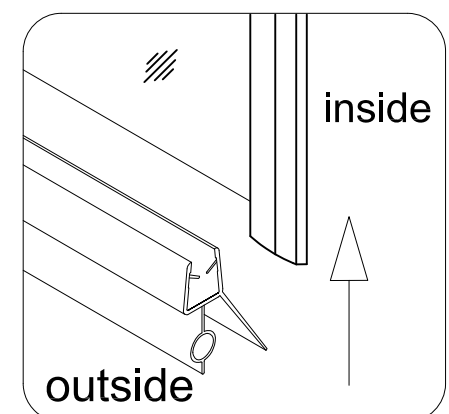

Figure 14

15. Install the Handle (08) to the Glass Door (02) using the hardware provided.

See Figure 15.

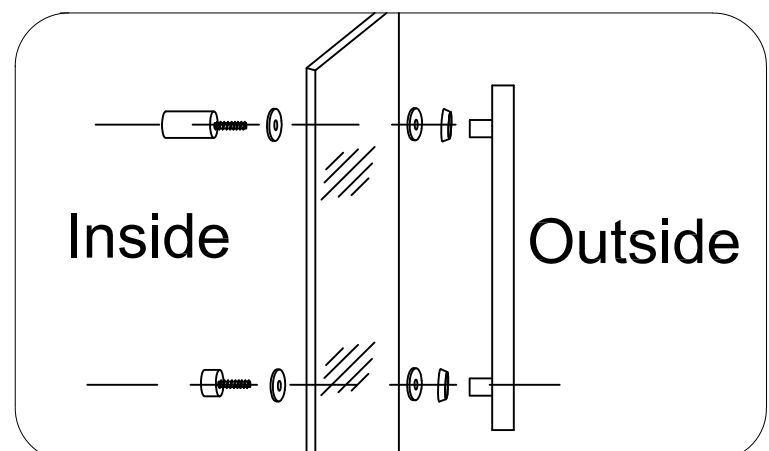

Figure 15

16. Position the Support bar (04) on the Hinged Stationary glass (01). Using a level, check support bar is level and mark the bracket's location on the shower wall.

Remove the Support bar (04) from the Hinged Stationary glass (01) and detach the wall bracket. Position the wall bracket to the marked area on shower wall and mark the drilling location on shower wall.

Drill the hole using 5/16" drill bit.

If your surface is prone to cracking or chipping then is recommended that you pilot drill first using a smaller drill bit, and then step up to the final size.

Insert the Wall anchor (05) and fasten the bracket to the wall with M5X60 screw (06).

Attach the Support bar (04) to the wall bracket and the Hinged Stationary Glass (01) (with gasket in place) and tighten the set screws to secure in place.

See Figure 16 for details.

17. Apply silicone sealant to edge of Stationary glasses (01)/(03) and shower wall, and Stationary glasses (01)/(03) and shower base.

See Figure 17 for details.

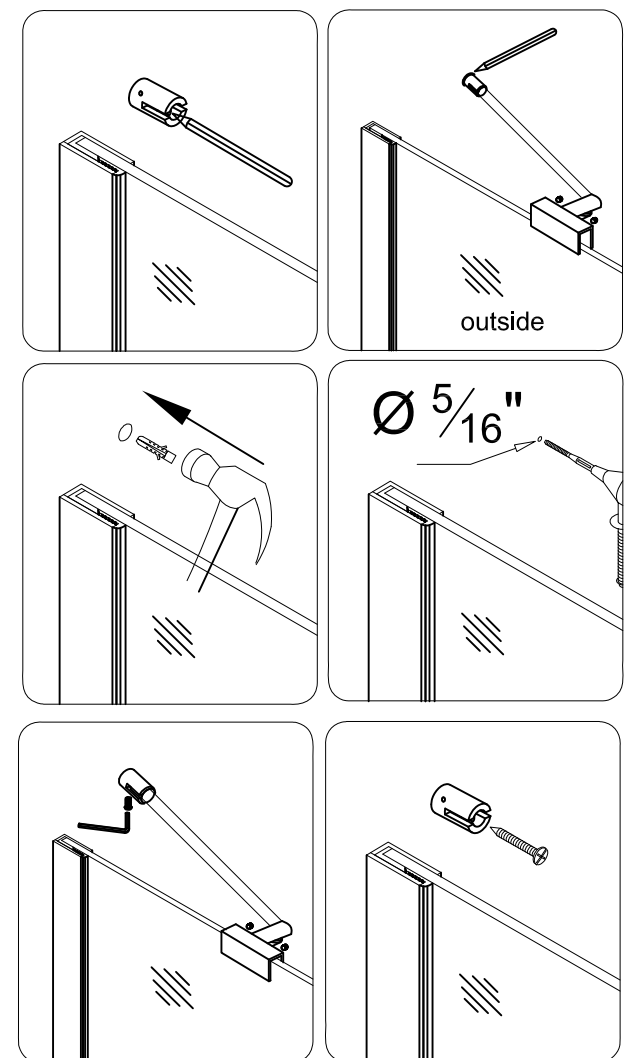

Figure 16

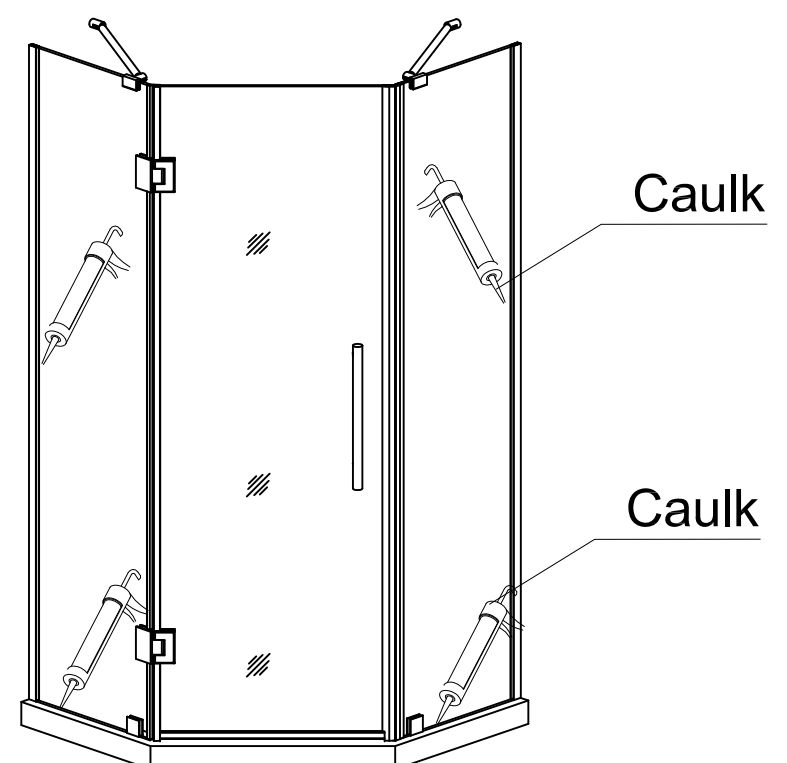

Figure 17

TURIN CANADA LIMITED WARRANTY

PLEASE READ THESE WARRANTY TERMS AND CONDITIONS CAREFULLY BEFORE USING YOUR TURIN CANADA BATHROOM PRODUCT. BY USING THE PRODUCT, YOU ARE CONSENTING TO BE BOUND BY THE FOLLOWING WARRANTY TERMS AND CONDITIONS. SHOWER DOOR/SHOWER BASE/SHOWER GLASS

Turin Canada Parts-Only Limited Warranty is five (5) years. Warranty for any part in black finish is limited to two (2) years.

Turin Canada warrants to the original retail purchaser ("Owner") of any Shower Door/Shower Base/Shower Glass product ("Product"), at the original installation site, for a period of Five (5) years (or two (2) years for any part in black) from date of purchase that the Product be free from manufacturing defects in materials and workmanship, when used under normal conditions and when such Product has not been modified or changed in any manner after leaving Turin Canada's warehouse. If any Product manufactured by Turin Canada is found to have manufacturing defects in materials or workmanship, such Product will be repaired or replaced by Turin Canada. This warranty applies only against defects discovered within the warranty period and extends only to the original purchaser of the Product. Parts repaired or replaced under the terms of this Warranty will be warranted for the remainder of the original warranty period only.

Proof of purchase is required to exercise this Warranty. Turin Canada may, at its option, examine and inspect the alleged defective Product, and Turin Canada may request that part(s) be returned to Turin Canada at Owner's expense for factory inspection. The determination as to whether Product shall be replaced, or in the alternative, repaired, shall be made solely by Turin Canada. If a Product is determined to be covered by the above Warranty, Turin Canada will ship the replacement part(s) to Customer. Parts not currently in stock may require up to a 6 weeks delivery time after placement of order.

The above warranty is subject to the following conditions: (1) the Product must be installed in a single-family dwelling unit where the original purchaser of the Product resides; and (2) the Product must be maintained as described in the owner's manual supplied with the Product.

For glass and acrylic panels, the customer must (a) open and inspect the Product upon delivery (without releasing the delivery driver until visual verification that the Product arrived in a good and acceptable condition); and (b) clearly notate damage on the delivery acknowledgment receipt. Failure to do so, and any damage discovered to glass or acrylic panel after delivery, will be repaired or replaced at the sole discretion of Turin Canada.

THIS WARRANTY DOES NOT COVER:

1. Product installed in buildings other than single-family dwelling units.
2. Product installed outdoors or any other non-standard bathroom location.
3. Component parts not manufactured by Turin Canada.

4. Workmanship of any installer of Turin Canada Product. This warranty does not assume any liability of any nature for unsatisfactory performance caused by improper installation, or any damages to property resulting from improper installation or use of the Products, including but not limited to flooring, subfloor, tile, walls, sheet rock, concrete board, paint, plumbing fixtures and ceilings.
5. Labour costs incurred in the removal, disassembly, reassembly, or installation of the Product(s), including replacement Products issued under the Warranty, or costs for transportation to Turin Canada, and any other materials necessary to return Product to Turin Canada.
6. Any Product that has been damaged as a result of being improperly serviced or operated, including, but not limited to, the following: operated with insufficient water; allowed to freeze; subjected to flood conditions; operated with water conditions or additives which cause unusual deposits or corrosion in or on the Product, or subject to any other abuse or negligence.
7. Any Product that has been damaged as a result of natural disasters, including, but not limited to, lightning, fire, earthquake, hurricanes, tornadoes or floods.
8. Product used for any purpose other than residential bathroom usage.

LEGAL DISCLAIMERS

ALL IMPLIED WARRANTIES, INCLUDING WARRANTIES OF MERCHANTABILITY AND FITNESS FOR A PARTICULAR PURPOSE, ARE HEREBY DISCLAIMED IN THEIR ENTIRETY WITH RESPECT TO ALL PURCHASERS OR OWNERS. FAILURE TO RETURN THE WARRANTY CARD SHALL HAVE NO EFFECT ON THE DISCLAIMER OF THESE IMPLIED WARRANTIES. ALL EXPRESS WARRANTIES SHALL BE LIMITED TO THE DURATION OF THIS EXPRESS LIMITED WARRANTY AND EXCLUDE ANY LIABILITY FOR CONSEQUENTIAL OR INCIDENTAL DAMAGES RESULTING FROM THE BREACH OF ANY EXPRESS WARRANTY. Some states do not allow the exclusion or limitation of incidental or consequential damages, so the above limitations or exclusions may not apply. No dealer, distributor, Service Company or other party is authorized to change, modify or extend the terms of this warranty in any manner whatsoever.

Turin Canada and its representatives shall not be liable for any injury, loss, cost or other damages, whether incidental or consequential, arising out of any defect covered by this Warranty including and without limitation, loss of use of the Product and cost for removal of defective Product, even if Turin Canada has been advised of the possibility of such damage. The liability of Turin Canada under this Warranty, if any, shall not exceed the original amount paid for the Product covered by the Warranty. Coverage under this Warranty shall commence as of the original date of purchase and the duration of such coverage shall not extend for any reason whatsoever beyond the stated time period. Please remember to register your new Turin Canada product to ensure accurate and satisfactory customer service.

Durin