

# Durin

## INSTALLATION AND OWNER'S MANUAL

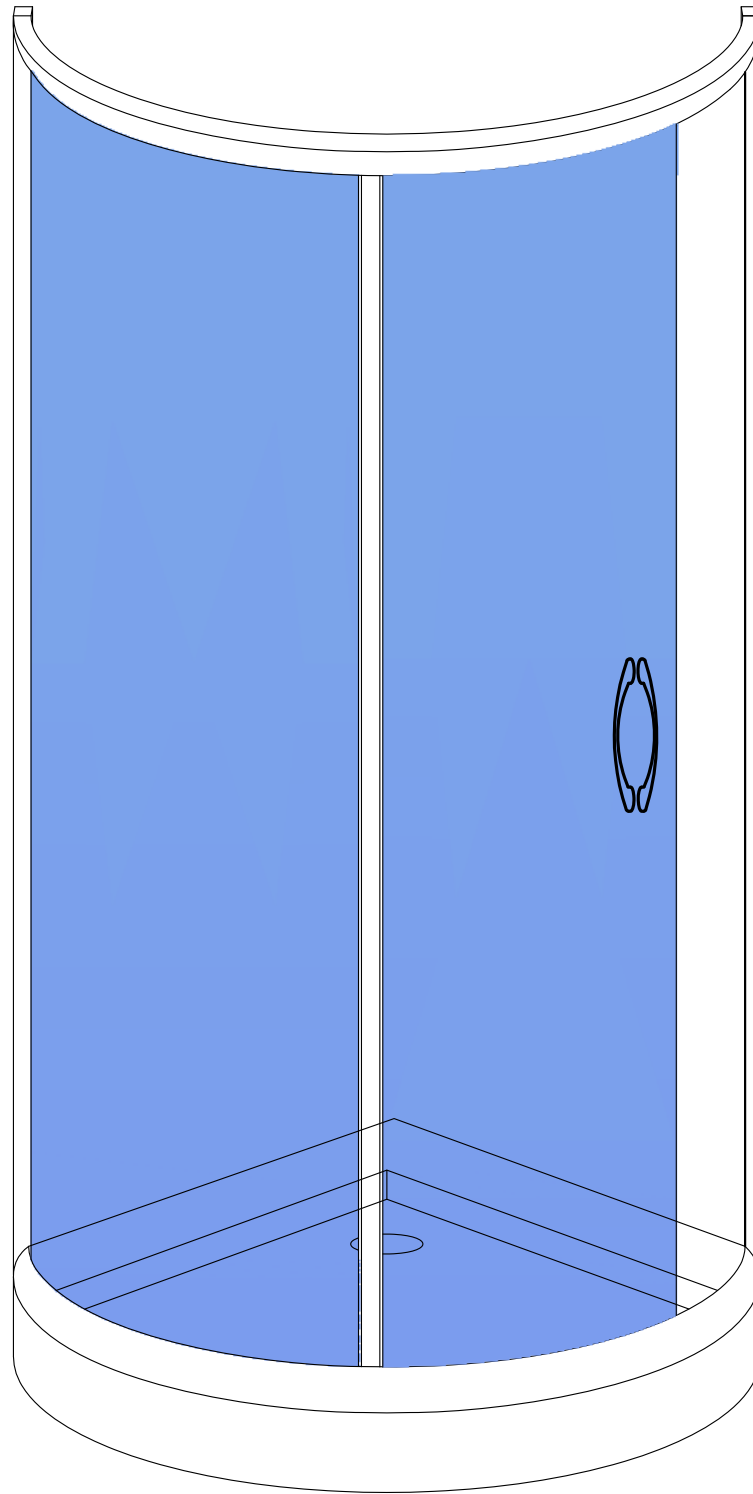

**Shower Door Model Number: MAXIMUM TU-SK-908-40-40-C**

Please carefully read these instructions before you begin to install the products.

# Before you start



Thank you for purchasing your shower door and tray. We hope that it will provide you with years of satisfying use and enjoyment.

Please read this manual carefully because it contains information and instructions about the proper installation of the unit. If you do not follow certain conditions of installation and maintenance, your warranty may be affected.

Shower door's and shower tray's feature:

- Tempered Safety Glass
- High quality hardware
- Easy maintenance durable fiberglass reinforced acrylic

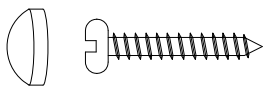
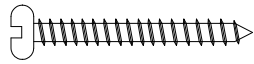
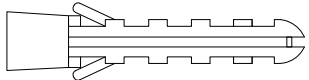
# SUPPLIED HARDWARE

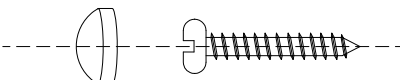
SCREW PACK (1)	M5x16.5		8
SCREW PACK (2)	M4x30		8
SCREW PACK (3)	expand tube		6
	M4x40		6
SCREW PACK (4)	M4x12		6

# SUPPLIED PARTS

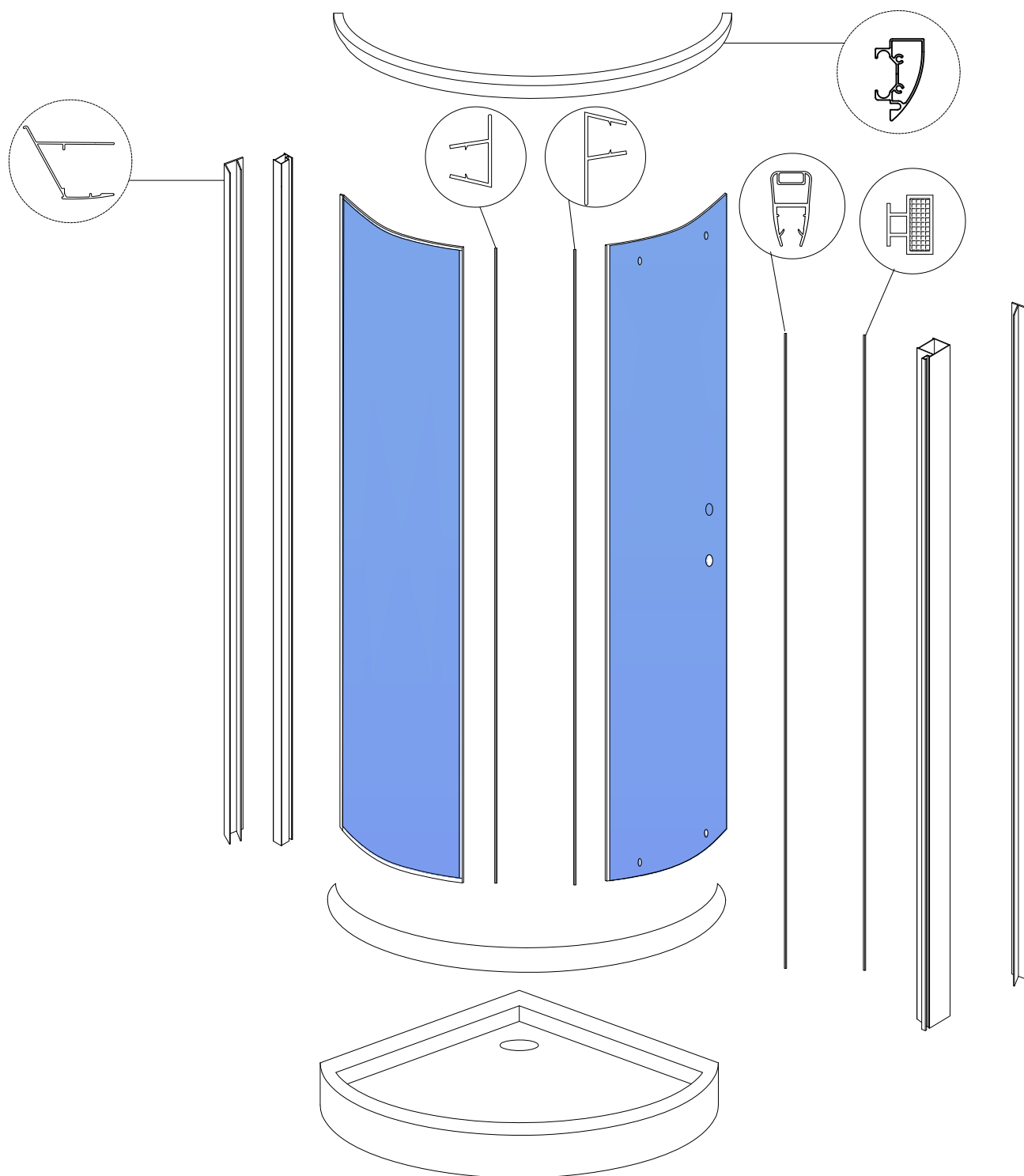

# Installation Guide

Please read and follow the installation instructions and guidelines in this section. Failure to follow the recommended instructions and installation techniques may lead to possible damage to the unit or the surrounding area and can affect warranty claims.

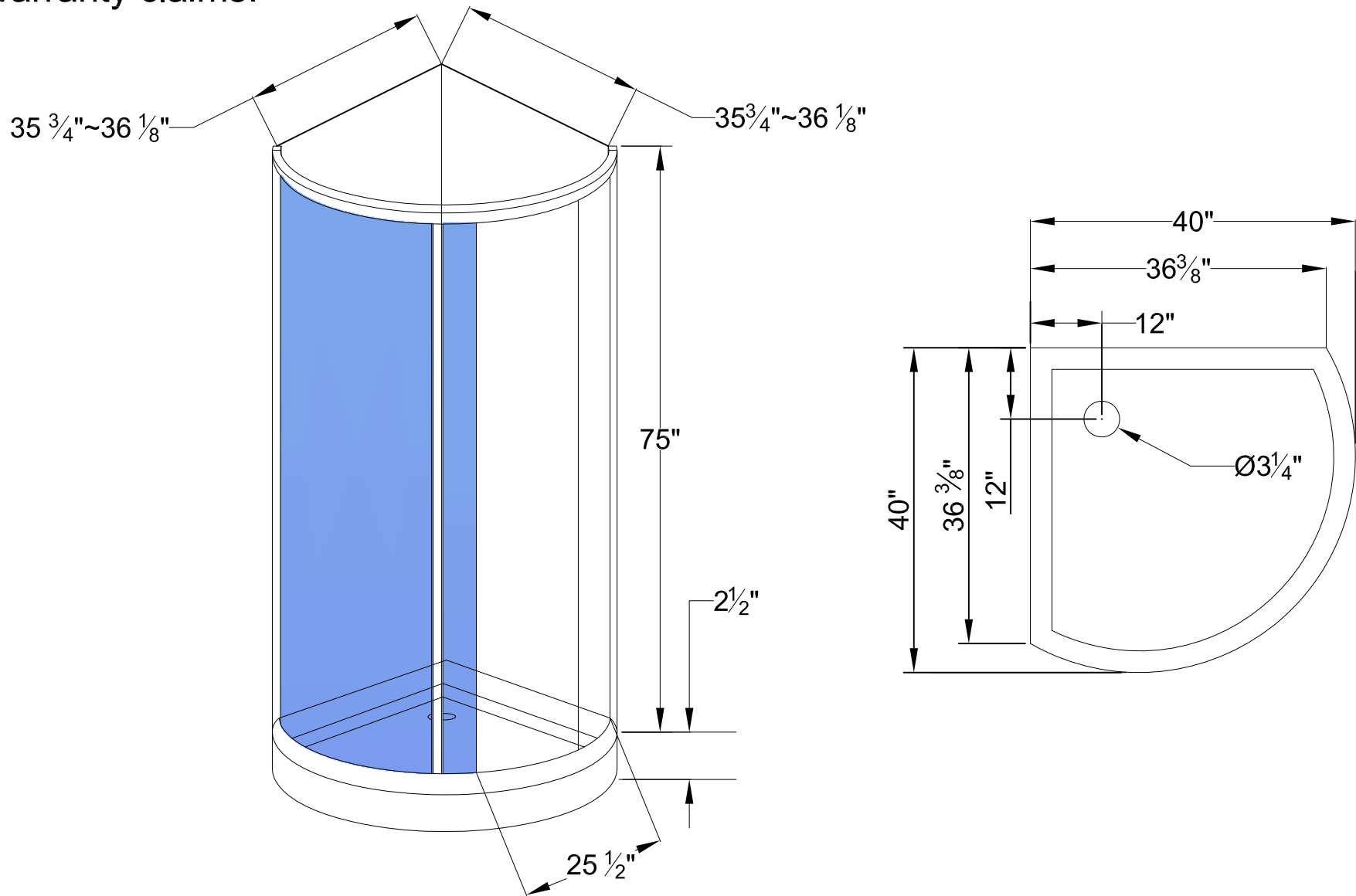

**ATTENTION:** This unit requires assembly. A minimum of two people are required for assembly, as several of the sections can be large and unstable until assembled.

**You will need the following tools:**

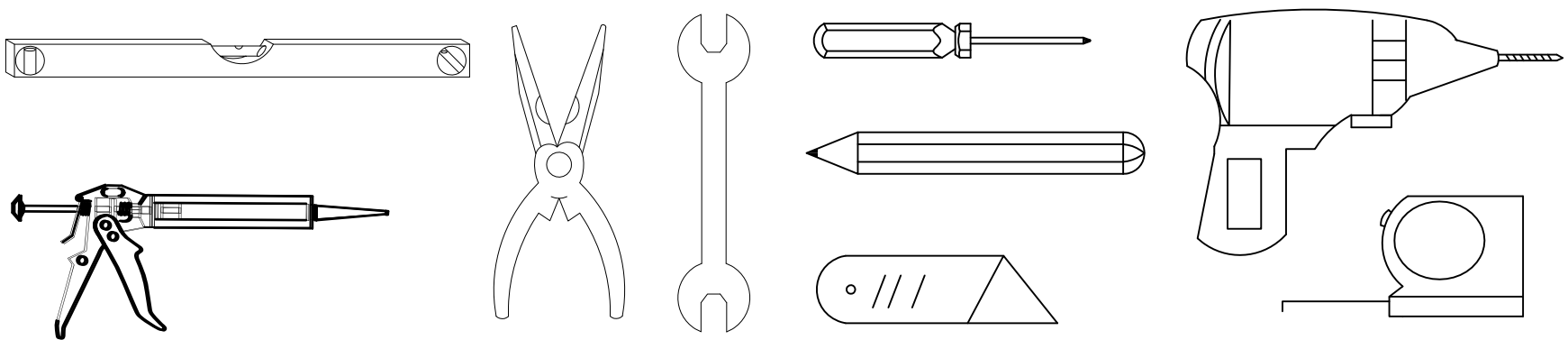

- Drill with screwdriver attachments
- Caulk gun
- Level (3 foot or longer is recommended)
- Tape measure
- Phillips head screw driver
- Flat head screw driver

- Bathroom rated silicone sealant

### **Items required but not supplied**

- Ø2.0" inch Drain Kit Shower pan hole diameter Ø 3-1/4"
- Dry wall screws or other fasteners

Before starting the installation, please ensure that you have inspected all components of the unit and check for broken or damaged sections. If you find damage, please contact your dealer or the manufacturer.

Locate the accessory and manual box and remove the individual screw and hardware packages and lay them out in sequential order to aid in completing the rest of the installation

# Preparation of base for installation of shower tray

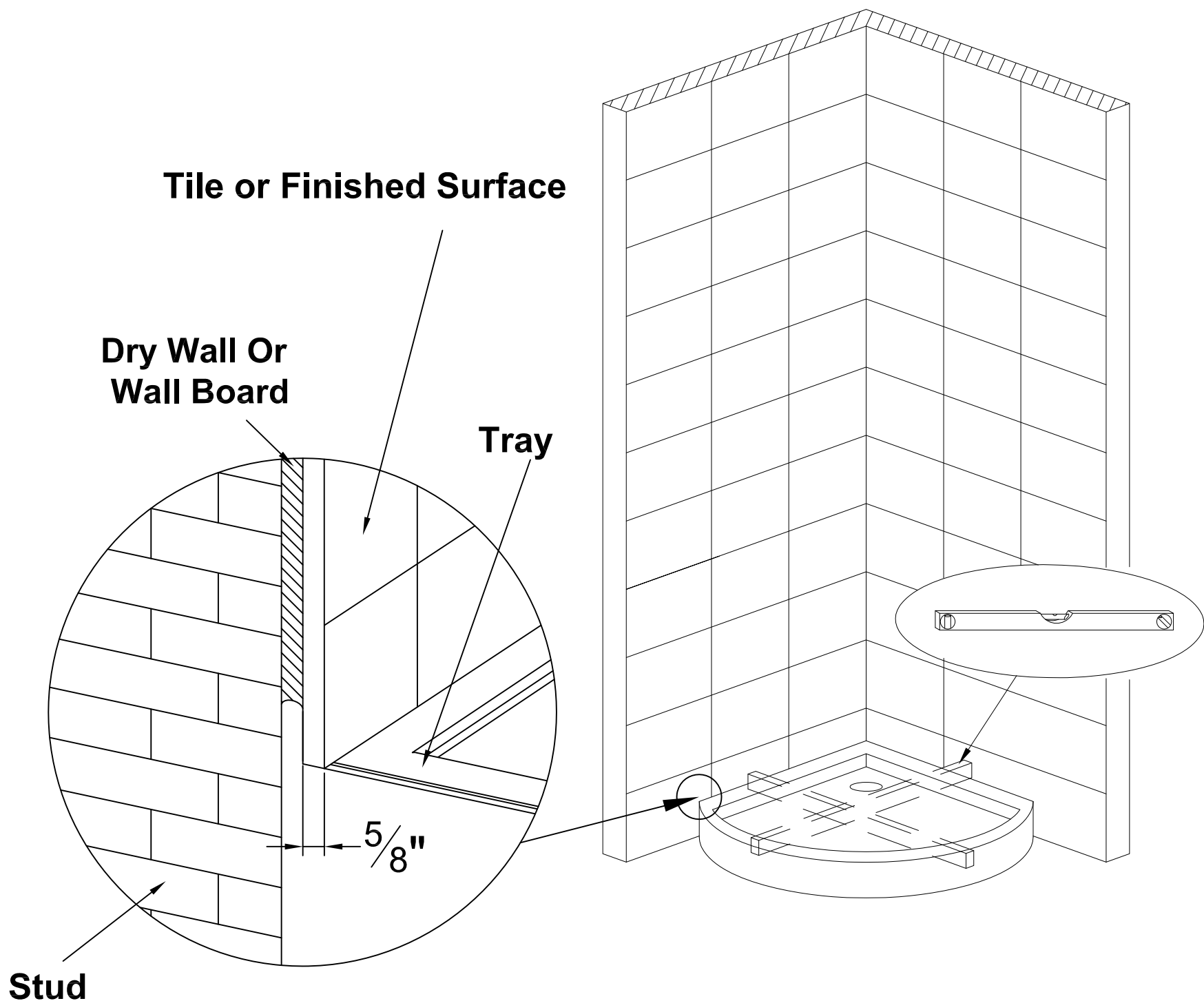

**WARNING:** The Shower door and tray are designed to be used with tile walls, if you are using a premade Acrylic/ABS/FRP shower stall that will be thicker than average wall board plus tile then you must consider the offset of the premade panel the shower tray has  $\frac{1}{4}$ " of tolerance for over sized wall thickness

The shower tray needs to sit on a flat level base for proper support. Ensure that the area for the shower tray is properly prepared for installation.

Using the drawing provide place the floor drain in the proper location so that the shower tray drain and the floor drain are in line after final installation.

Place the shower tray in the final installation position line up the drain holes and check for level. If not level make adjustments to the floor at this time.

This can be accomplished by leveling the subfloor by use of Shims, Leveling compound or placing the shower tray into a mortar base

The shower tray must be installed so that the tile lip is up against the wall studs it is recommend that the tray is fixed to the studs with the use of screws.

**IMPORTANT: If you are using screws to secure the tray to the studs it is recommended that you pilot drill the screw location as to prevent the acrylic tray from chipping or cracking.**

# Assemble the glass panel

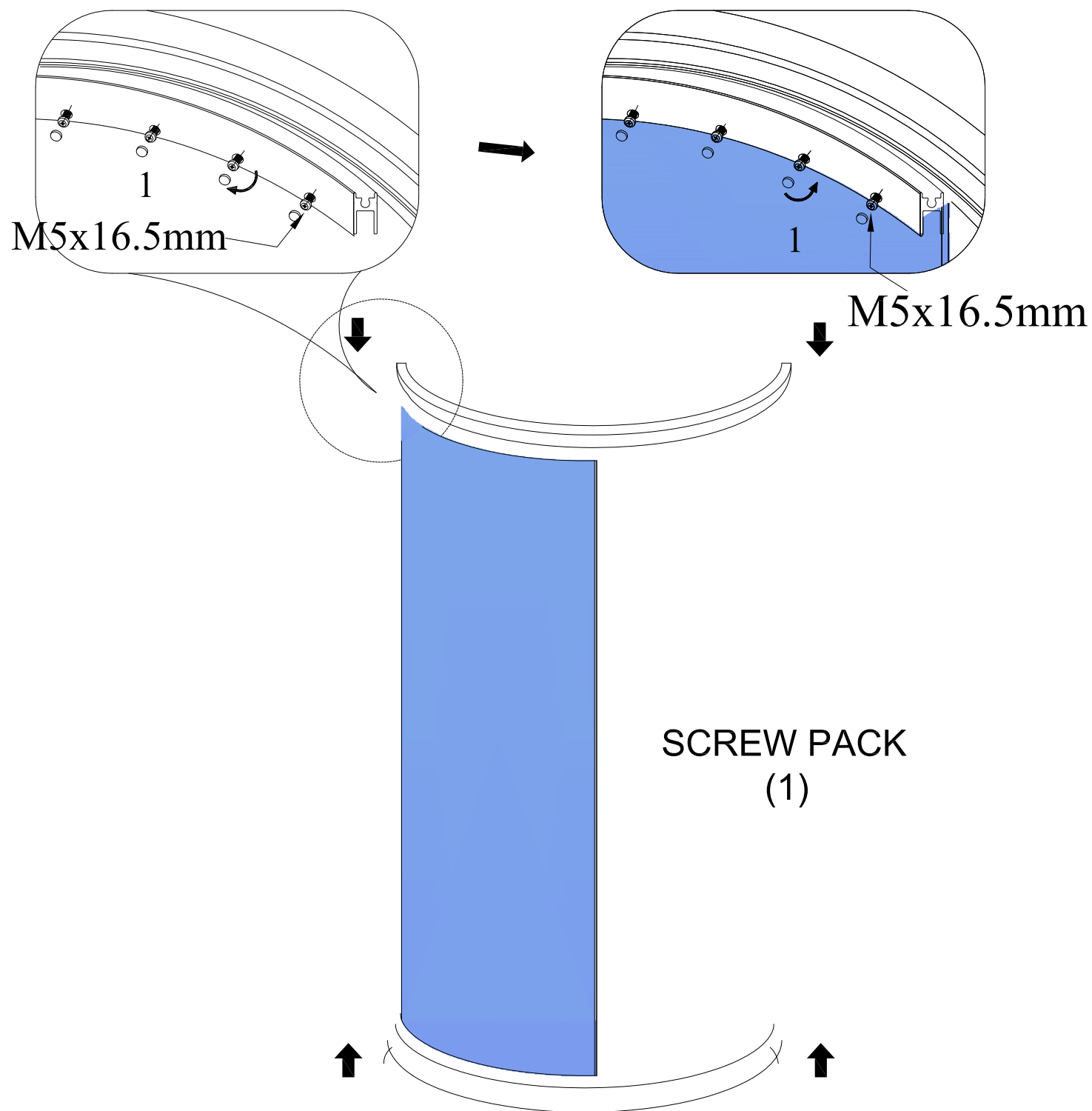

**NOTE: The door opening is reversible if you wish to change the opening assemble the Glass panel as described below then reverse when installing onto the shower tray. The top and bottom aluminum curved channels are identical.**

1. Remove and inspect all of the glass panels. If any are broken, please contact your dealer or the manufacturer.
2. Remove and inspect the aluminum top and bottom rails for the glass assembly.

**IMPORTANT: Please take note that Screw Pack contains several different lengths of screws each for a specific location within the glass assembly. During the next steps of assembly, pay close attention so the correct screw length is used in the correct location. Failure to do this can cause damage to the glass panels and possibly result in leaks.**

3. Place an aluminum rail on the floor with correct orientation up to receive the glass panel.



4. Apply a liberal bead of sealant on the bottom rail from the slot that receives the glass panel out to the end of the rail.

**NOTE:** The next steps of assembly will require two people.

5. Slide glass panel and insert it into the slot on the bottom rail.
6. Take other aluminum rail and apply a liberal bead of sealant from the slot for the glass panel out to the end of the rail.
7. Line up the slot on the top rail with the receiving tabs on the glass panel and insert the top rail on to the glass panels.
8. Apply some sealant to the end of the Aluminum rails, then using the screws provided follow the diagram to insert the correct screw length in to the correct location.

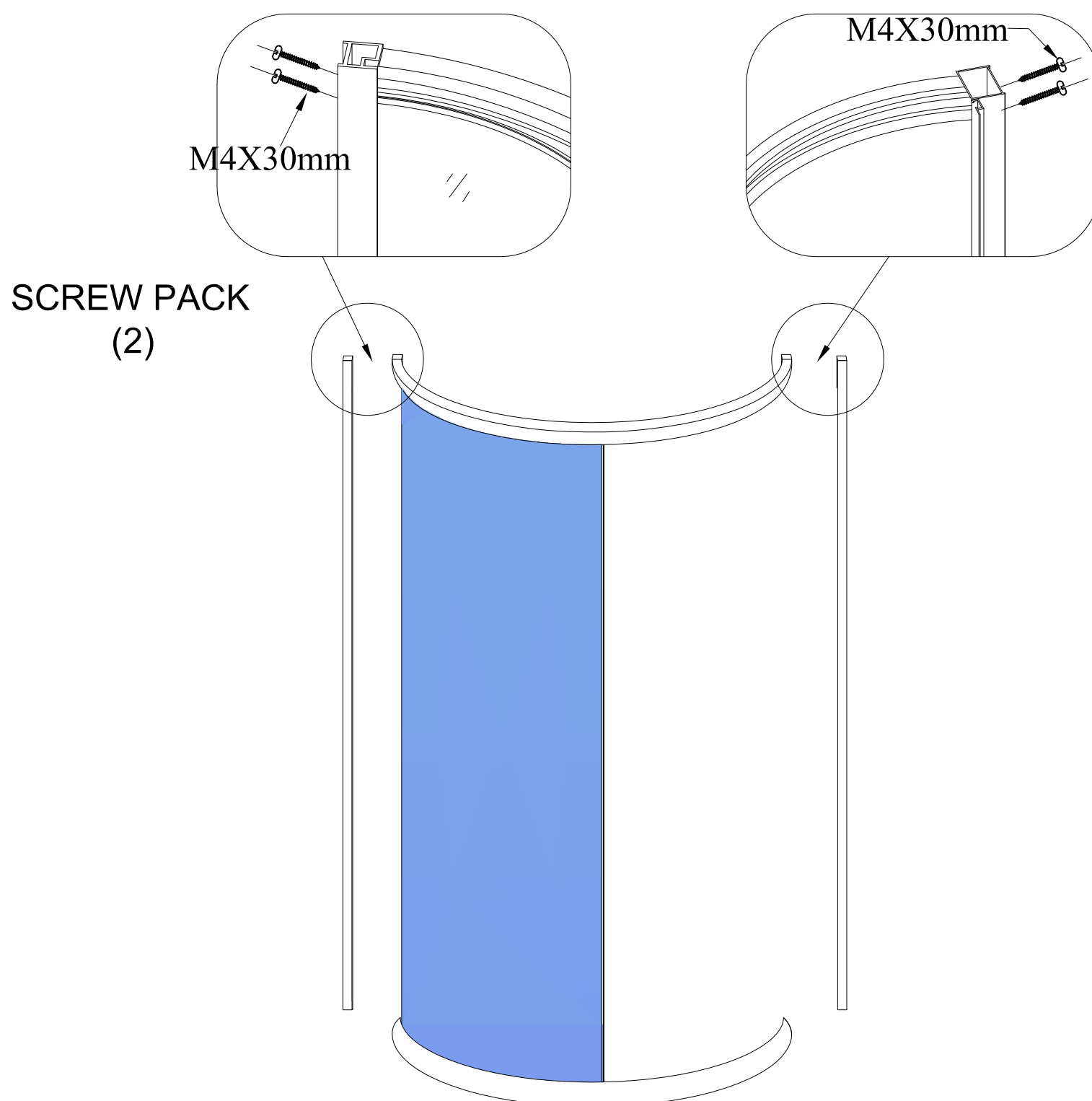

9. After all the screws are in place and secure, wipe any excessive sealant and use the excess to fill any cracks or gaps between the joints.

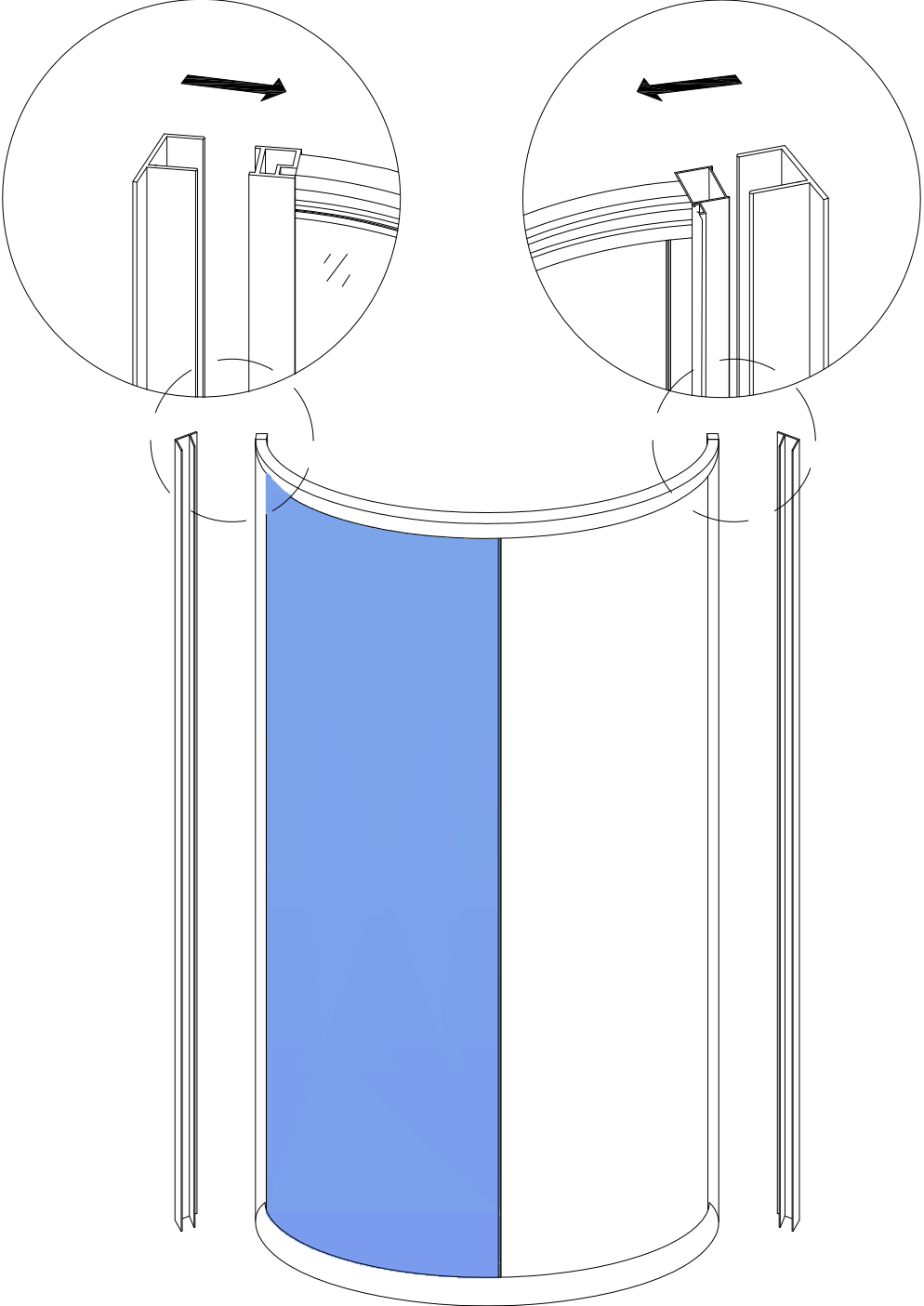

10. Cover the exposed screw heads with decorative plastic screw head covers

# Mark the Glass panel mounting holes

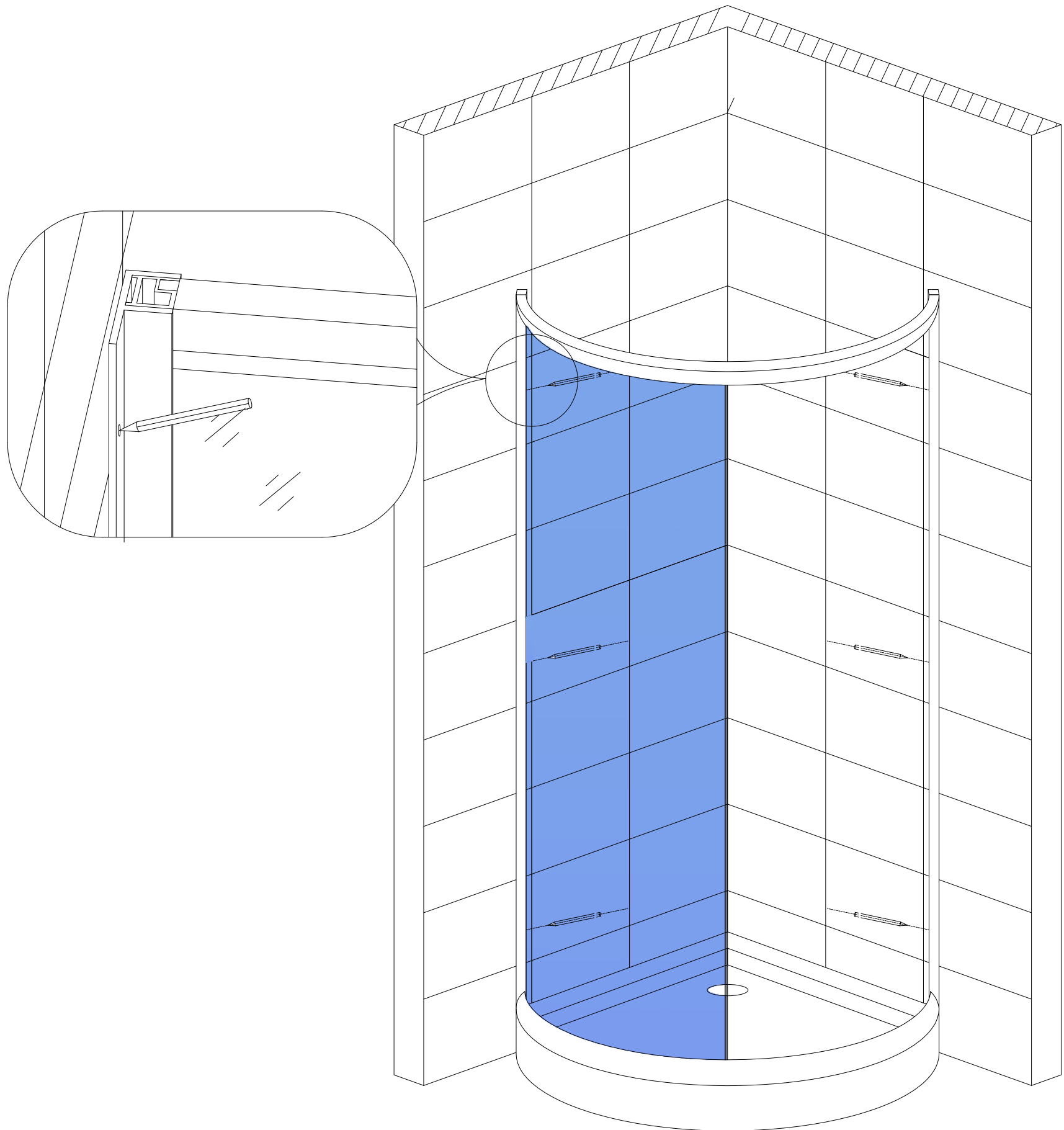

Place the assembled glass wall panel onto the shower tray and mark the predrilled holes onto the wall. Remove after marking the walls.

# Drilling and installing the wall anchors

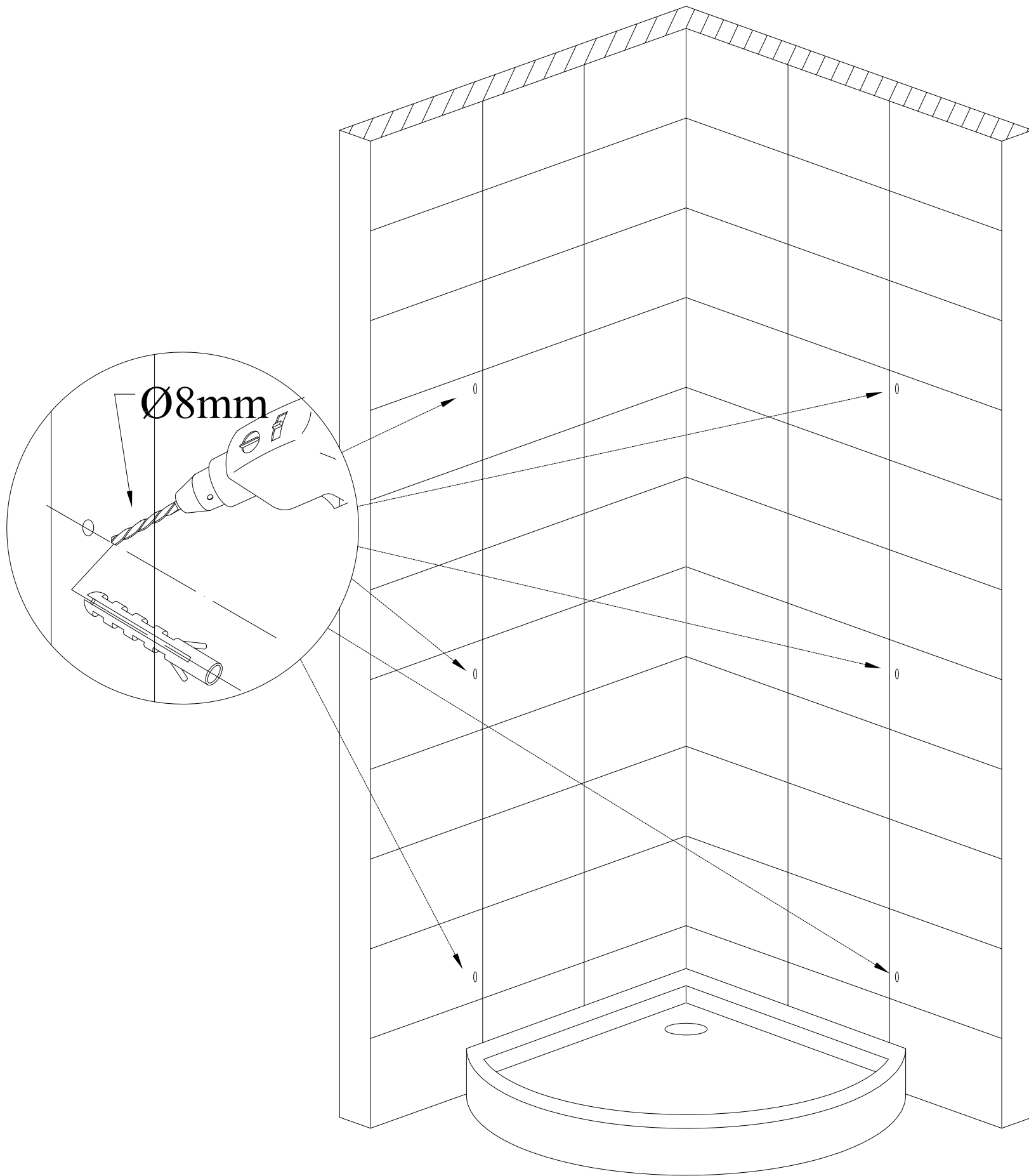

Using the appropriate drill bit for your wall surface drill each hole location with a 5/16" diameter drill bit. Install the plastic wall anchors provided into the drilled holes

**NOTE:** If your surface is prone to cracking or chipping then it is recommended that you pilot drill first using a smaller drill bit, and then step up to the final size.

# Secure the glass wall panel to the walls

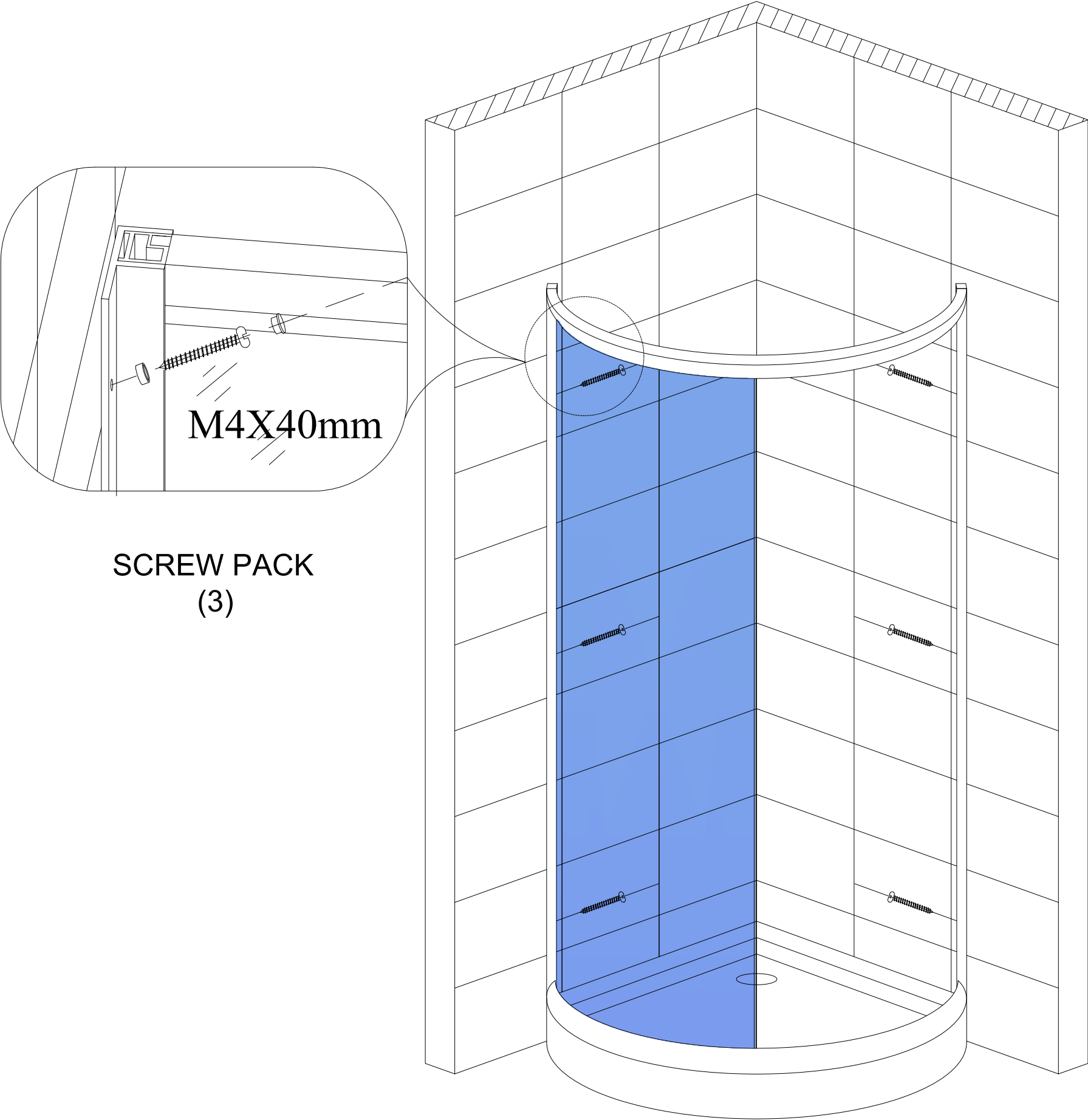

Using the screws provided secure the glass wall panel to the walls.

# Secure the glass wall panel

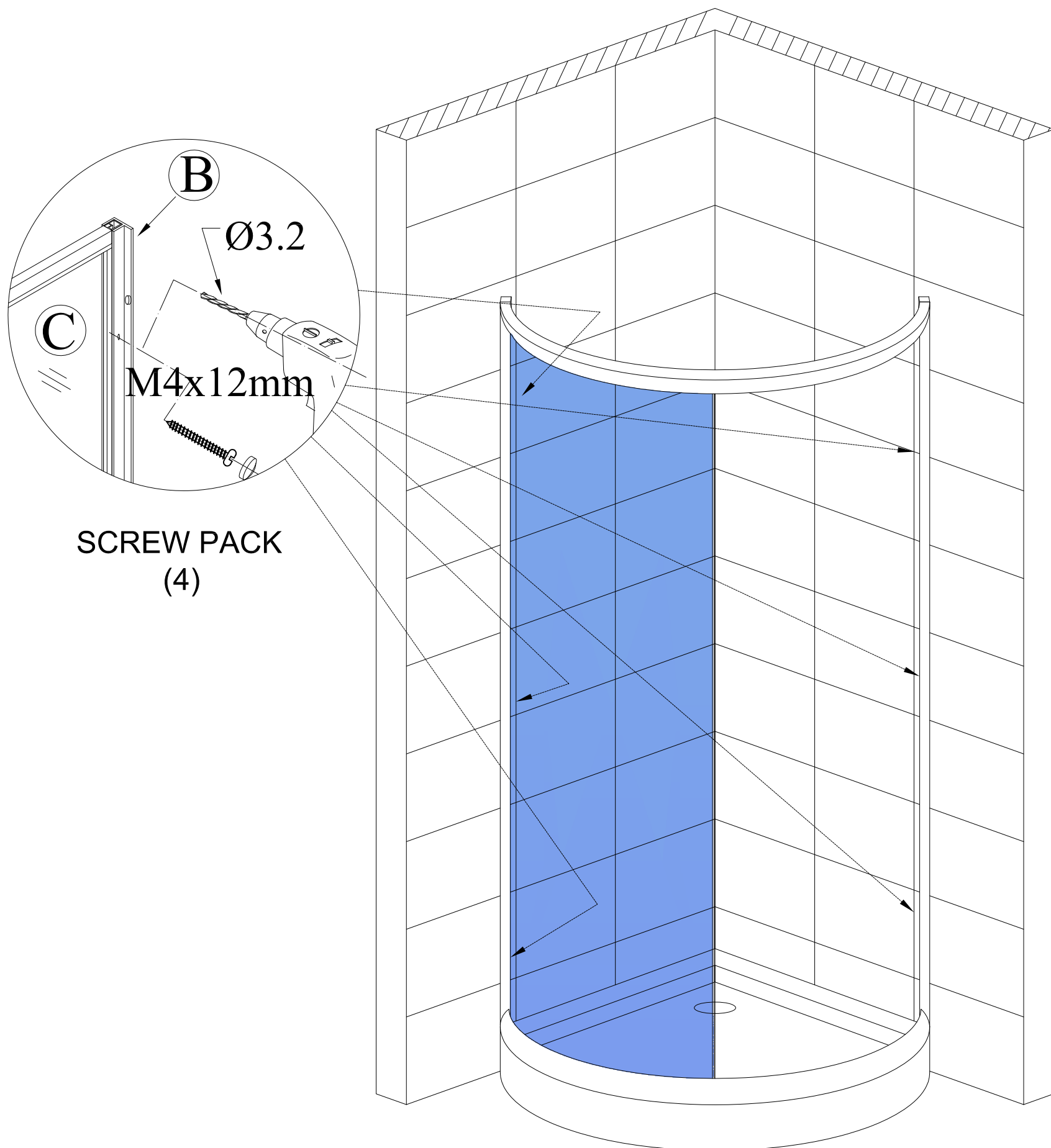

Use a  $\text{Ø}1/8$  inch diameter drill bit and drill 3 equally spaced holes along each wall channel on the inside of the shower. Do not drill all the way thru to the other side drill only until the drill bit enters the void in the wall channel. Using the hardware provided secure the fixed glass panel to the wall channel. Repeat on the other side. Decorative covers are also provided to cover the screw heads

# Install glass sliding door

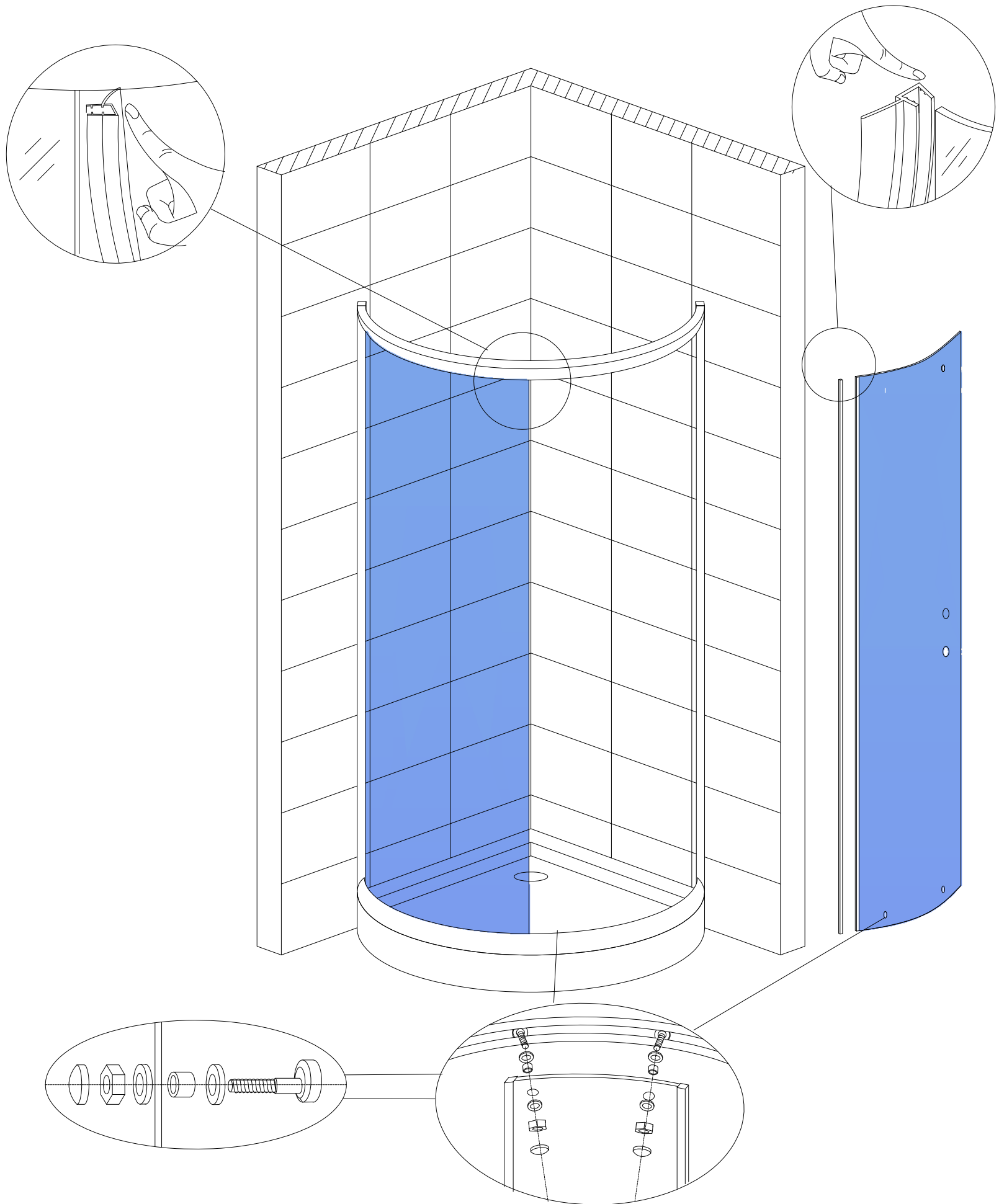

1. Remove and inspect the glass door. If any are damaged or broken, please contact your dealer or the manufacturer.
2. Four roller mount assemblies for the door are located inside on the unit on the upper and lower aluminum rails.
3. Carefully disassemble each door roller mount assembly.

**IMPORTANT:** Note the disassembly order of the roller mount assembly. It is critical that the order be repeated for proper adjustments of the doors. Please see the illustration provided.

4. Remove the decorative nut, locking nut, and plastic washer. Leave the plastic tube and back plastic washer on the door roller.
5. Taking the door, and slide the door over the top two-door roller mounts.  
**IMPORTANT:** The plastic tubes must be inserted into the two top mounting holes in the door.
6. Reinstall the plastic washers onto the top roller and then install the metal locking nuts. Hand tighten the locking nuts.
7. Repeat the process on the two lower roller mounts ensuring that the plastic tubes are inserted in the glass door and then reinstall the plastic washer and metal locking nut and hand tighten.
8. Check the door seal down the length of the seal. If it is not in full contact, use a flat head screw driver and adjust the top roller mounts so that the door seal is in contact for the entire length of the door.

**NOTE:** A cam roller inside of the door roller is used for adjustments of the door. By turning this cam, you will raise or lower the door by adjusting the seal.

9. After making the final adjustments, tighten all of the metal locking nuts.
10. Install the decorative nut covers.
11. Install the vinyl door “F” type seals on each door so that the squeegee flaps will wipe the glass when opening and closing.



# Install the door handles

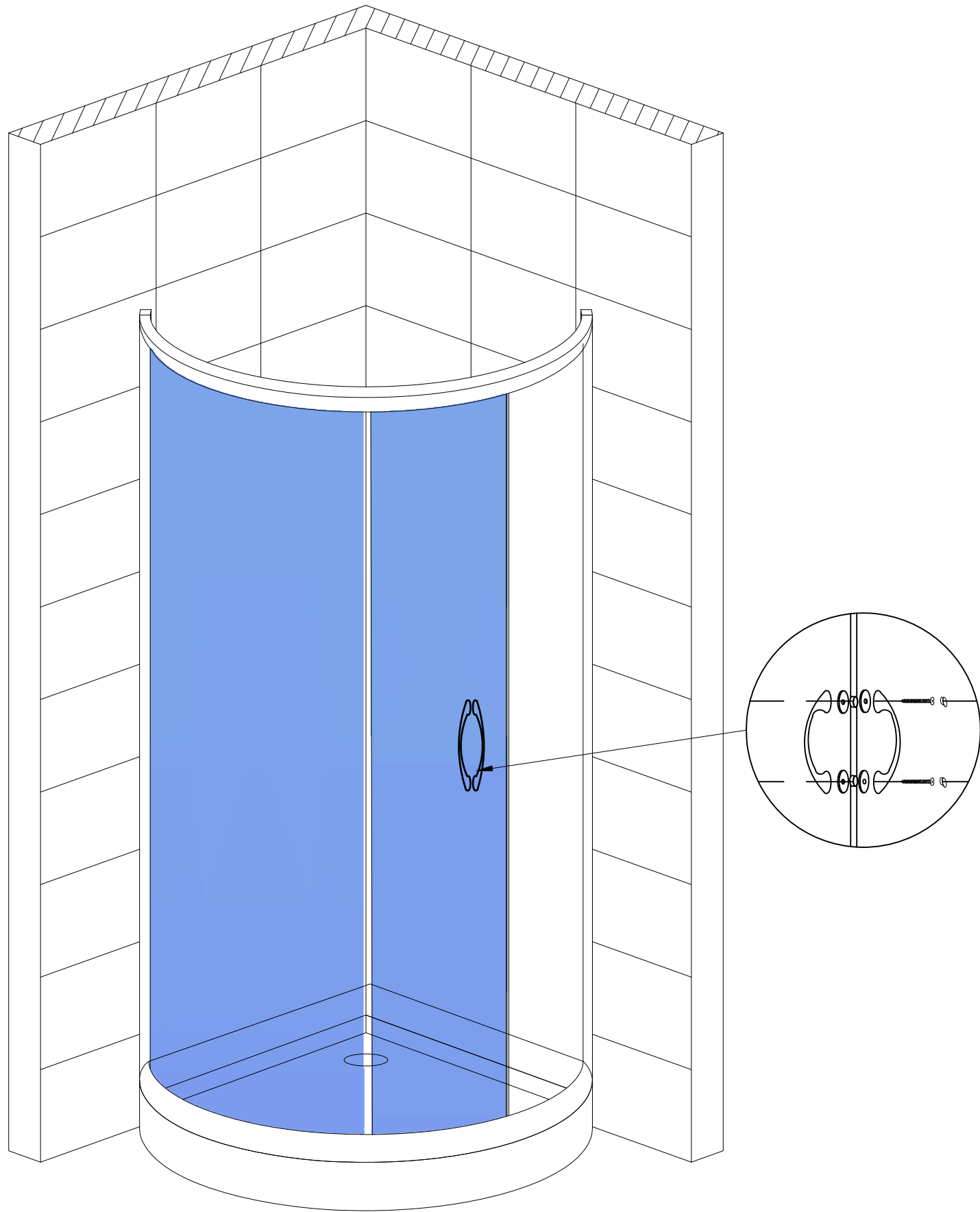

1. The door handles are located within the accessory manual box. Remove them from the packaging and note the end with the knob on it. The door knob will be located to the top after final installation.
2. Remove the doorknob and one of the vinyl washers, but leave the plastic tube and the other vinyl washer.

**NOTE:** Sometimes when removing the doorknob the threaded stud will come out. If this happens, remove the stud from the doorknob and thread it back into the door handle at least two or three turns or until it bottoms out.

3. Insert the door handle with the threaded stud into the top hole on the glass door with the plastic tube in the hole and the vinyl washer between the glass and the door handle.
4. Install the remaining vinyl washer onto the stud and then install the doorknob.

Located within the packaging for the door handles you will find:

- a.2 Vinyl washer
- b.2 Screws
- c.1 Hard plastic washers
- d.1 Decorative covers

5. Insert one of the screws through the hard plastic washers and then install the screw with the plastic washer into the door handle with one of the vinyl washers in between the hard plastic washer and the glass door.
6. After the door handle is secure, install the decorative cover over the screw and hard plastic washer.

# Final sealing

Using bathroom rated silicone sealant or caulk seal the bottom of each fixed glass panels to the shower tray and seal along each wall channel where the wall channel meets the wall.

# TURIN CANADA LIMITED WARRANTY

PLEASE READ THESE WARRANTY TERMS AND CONDITIONS CAREFULLY BEFORE USING YOUR TURIN CANADA BATHROOM PRODUCT. BY USING THE PRODUCT, YOU ARE CONSENTING TO BE BOUND BY THE FOLLOWING WARRANTY TERMS AND CONDITIONS. SHOWER DOOR/SHOWER BASE/SHOWER GLASS

Turin Canada Parts-Only Limited Warranty is five (5) years. Warranty for any part in black finish is limited to two (2) years.

Turin Canada warrants to the original retail purchaser ("Owner") of any Shower Door/Shower Base/Shower Glass product ("Product"), at the original installation site, for a period of Five (5) years (or two (2) years for any part in black) from date of purchase that the Product be free from manufacturing defects in materials and workmanship, when used under normal conditions and when such Product has not been modified or changed in any manner after leaving Turin Canada's warehouse. If any Product manufactured by Turin Canada is found to have manufacturing defects in materials or workmanship, such Product will be repaired or replaced by Turin Canada. This warranty applies only against defects discovered within the warranty period and extends only to the original purchaser of the Product. Parts repaired or replaced under the terms of this Warranty will be warranted for the remainder of the original warranty period only.

Proof of purchase is required to exercise this Warranty. Turin Canada may, at its option, examine and inspect the alleged defective Product, and Turin Canada may request that part(s) be returned to Turin Canada at Owner's expense for factory inspection. The determination as to whether Product shall be replaced, or in the alternative, repaired, shall be made solely by Turin Canada. If a Product is determined to be covered by the above Warranty, Turin Canada will ship the replacement part(s) to Customer. Parts not currently in stock may require up to a 6 weeks delivery time after placement of order.

The above warranty is subject to the following conditions: (1) the Product must be installed in a single-family dwelling unit where the original purchaser of the Product resides; and (2) the Product must be maintained as described in the owner's manual supplied with the Product.

For glass and acrylic panels, the customer must (a) open and inspect the Product upon delivery (without releasing the delivery driver until visual verification that the Product arrived in a good and acceptable condition); and (b) clearly notate damage on the delivery acknowledgment receipt. Failure to do so, and any damage discovered to glass or acrylic panel after delivery, will be repaired or replaced at the sole discretion of Turin Canada.

THIS WARRANTY DOES NOT COVER:

1. Product installed in buildings other than single-family dwelling units.
2. Product installed outdoors or any other non-standard bathroom location.
3. Component parts not manufactured by Turin Canada.

4. Workmanship of any installer of Turin Canada Product. This warranty does not assume any liability of any nature for unsatisfactory performance caused by improper installation, or any damages to property resulting from improper installation or use of the Products, including but not limited to flooring, subfloor, tile, walls, sheet rock, concrete board, paint, plumbing fixtures and ceilings.
5. Labour costs incurred in the removal, disassembly, reassembly, or installation of the Product(s), including replacement Products issued under the Warranty, or costs for transportation to Turin Canada, and any other materials necessary to return Product to Turin Canada.
6. Any Product that has been damaged as a result of being improperly serviced or operated, including, but not limited to, the following: operated with insufficient water; allowed to freeze; subjected to flood conditions; operated with water conditions or additives which cause unusual deposits or corrosion in or on the Product, or subject to any other abuse or negligence.
7. Any Product that has been damaged as a result of natural disasters, including, but not limited to, lightning, fire, earthquake, hurricanes, tornadoes or floods.
8. Product used for any purpose other than residential bathroom usage.

#### LEGAL DISCLAIMERS

ALL IMPLIED WARRANTIES, INCLUDING WARRANTIES OF MERCHANTABILITY AND FITNESS FOR A PARTICULAR PURPOSE, ARE HEREBY DISCLAIMED IN THEIR ENTIRETY WITH RESPECT TO ALL PURCHASERS OR OWNERS. FAILURE TO RETURN THE WARRANTY CARD SHALL HAVE NO EFFECT ON THE DISCLAIMER OF THESE IMPLIED WARRANTIES. ALL EXPRESS WARRANTIES SHALL BE LIMITED TO THE DURATION OF THIS EXPRESS LIMITED WARRANTY AND EXCLUDE ANY LIABILITY FOR CONSEQUENTIAL OR INCIDENTAL DAMAGES RESULTING FROM THE BREACH OF ANY EXPRESS WARRANTY. Some states do not allow the exclusion or limitation of incidental or consequential damages, so the above limitations or exclusions may not apply. No dealer, distributor, Service Company or other party is authorized to change, modify or extend the terms of this warranty in any manner whatsoever.

Turin Canada and its representatives shall not be liable for any injury, loss, cost or other damages, whether incidental or consequential, arising out of any defect covered by this Warranty including and without limitation, loss of use of the Product and cost for removal of defective Product, even if Turin Canada has been advised of the possibility of such damage. The liability of Turin Canada under this Warranty, if any, shall not exceed the original amount paid for the Product covered by the Warranty. Coverage under this Warranty shall commence as of the original date of purchase and the duration of such coverage shall not extend for any reason whatsoever beyond the stated time period. Please remember to register your new Turin Canada product to ensure accurate and satisfactory customer service.

*Durin*