

HOZAN

C-738

SPOKE TENSION METER



This product is special tool for measuring the tension of spokes used bicycle wheels. The capacities of this tool is written down on page ❶. Do not use it for any other purpose.

INSTRUCTION MANUAL

Thank you for purchasing the HOZAN C-738 SPOKE TENSION METER.

By controlling the spoke tension, you can assemble the correct wheel and diagnose wheel problems.



Please check the package contents.



This symbol urges caution. Make sure to read and follow the rules and the instructions.

- Please read this entire instruction manual carefully before attempting to place this product in service. Please keep this instruction manual available for reference.
- Please attach this instruction manual when transferred or lent for someone.

Contents

Identification of parts	2-3
Safety Precautions	3-4
Operation	4-9
Preparation for use	4-5
How to find the reference value	5-6
Main operation	7-9
Daily inspection	10
Maintenance / Storage method	10
Product disposal	10
Specifications	11
C-738 Spoke tension meter Conversion table	11

Identification of parts

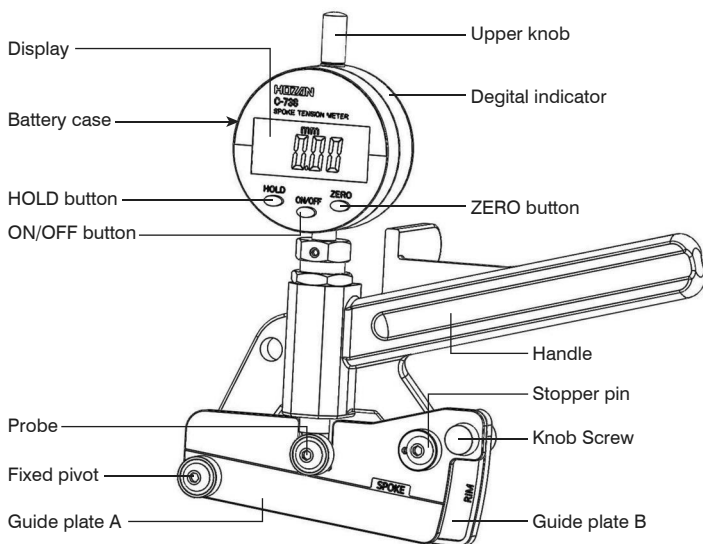

Identification of parts

Package contents



Main unit



Instruction manual

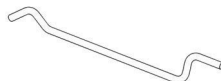

Checker



Coin type lithium battery
(for test operation)

Other necessary items

- Coin type lithium battery (CR2032)

Safety Precautions

Please read this safety precautions carefully before use to ensure correct use.

The following symbols are displayed in this instruction manual.

Symbols that may cause serious damage	Don't Not wet hands	Do No liquids	No disassembly
---------------------------------------	------------------------	------------------	----------------



These symbols are used throughout the instruction manual to alert the user to potential safety hazards as follows:

Warning ...Notice when incorrect handling could cause the user's death or serious injury.
Caution ...Notice when incorrect handling could cause injury to the user or material damage.

Even if the instructions do not have Caution mark, there are some possibilities for a serious situation. Follow the instructions.

Warning	
Do not leave the product in direct sunlight, in a car under the scorching sun, near a fire, etc.	May cause injury or malfunction.
Do not disassemble the product.	May cause malfunction or inaccurate measurement.
Do not use in a place where the product is likely to get wet.	May cause electric shock.
Do not use with wet hands.	
Do not use when the product is damaged, deformed or markedly worn.	May cause injury, malfunction or inaccurate measurement.

Safety Precautions

 Caution		
	Do not use for anything other than adaptive spokes.	May cause damage or malfunction.
	Do not drop or hit the product.	May cause injury, damage, malfunction or inaccurate measurement.

Operation

Preparation for use

How to insert the battery

1. Pull out battery case from the digital indicator.

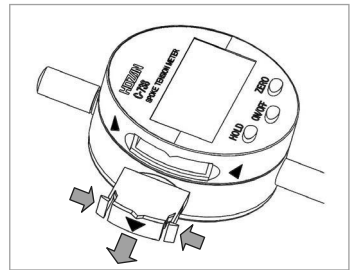

Pull out while holding both sides of the battery case.

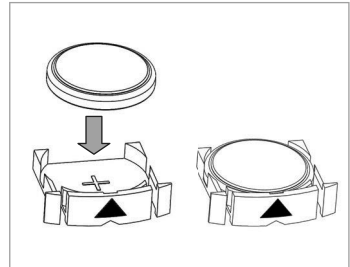

2. Set the coin type lithium battery (CR2032).

Place the coin type lithium battery in the battery case with the "PLUS(+)" side of the coin type lithium battery facing the battery case.



 Caution May cause electric shock, injury or malfunction.	
	Be sure to use the coin type lithium battery (CR2032).
	Do not touch with wet hands.

3. Insert the battery case to the digital indicator.

Set the battery case "▼" mark as shown.

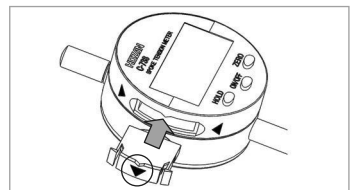

Operation

Preparation for use

4. Switch on and check the display.

Press the ON/OFF button. It is normal if the numbers are shown on the display.

If you don't see the numbers on the display, please open the battery case and check the direction of coin type lithium battery or replace the coin type lithium battery.

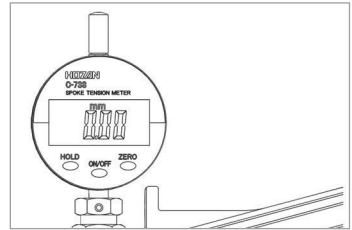

How to find the reference value

By using the checker, it is possible to easily check whether the C-738 is measuring correctly. You need to find the "reference value" before using the checker.

You should measure it when using for the first time after purchase.

1. Set the position of guide plate B to "CLOSE" as shown.



Caution

May cause inaccurate measurement.



If the knob screw is loose, tighten it.

2. Press the ON / OFF button to turn on the power.

Make sure the numbers are shown on the display.

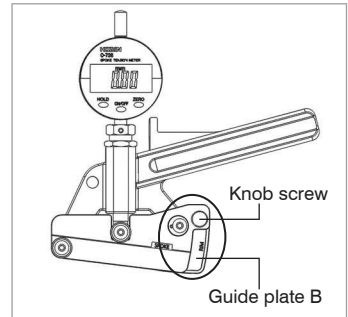

3. Perform zero adjustment.

Press the ZERO button to set the number on the display to "0.00mm".

Gently pull and release the upper knob at several times. Zero adjustment is complete when "0.00mm" is displayed stably.



Caution

May cause malfunction.



Do not pull the upper knob of the digital indicator with strong force. It will be broken.

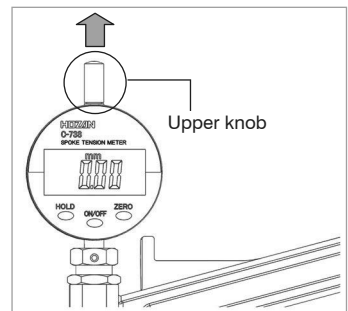

Operation

How to find the reference value

4. Set the checker as shown.

Hook the checker on the fixed pivot as shown.

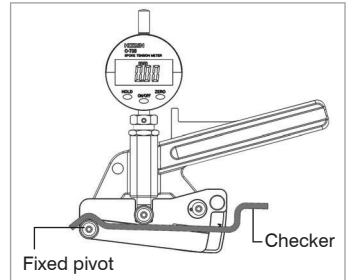

5. Hook your finger at the position of the arrow as shown and slowly push the checker up until the checker touches the stopper pin.

Hold the handle so that the main unit does not move.



Caution May cause inaccurate measurement.



Be careful not to leave the checker from the guide plate A.

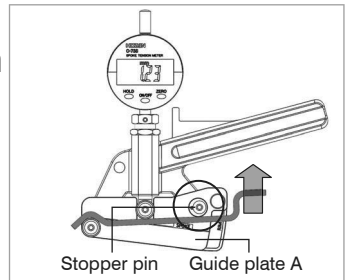

6. Read the measured value on the display with the checker and the stopper pin contacted.

This value is the reference value of your C-738 spoke tension meter.

Record it in the blank below.

This reference value is only for the product you purchased.

Daily inspections are performed using this reference value.

We do not have any records, so we cannot answer any inquiries you may have later.

Reference value	mm
-----------------	----

Operation

Main operation

1. Use the checker to make sure you can measure correctly.

Measure according to the procedure on page 5 to 6 "How to find the reference value".

Compare the measured value with the reference value.





Acceptance Range : The reference value $\pm 0.02\text{mm}$.

2. Check the spoke and the conversion table.

Check the spoke type, cross-sectional shape, cross-sectional dimensions, and material.

Look for the spoke corresponded their contents in the conversion table (Refer to page ① at the end of the instruction manual).

If there is no corresponding spoke in the conversion table, you will not be able to determine the tension value. However you will be able to check the relative condition of each spokes in wheel.

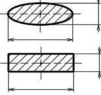
Type	Plain	Butted	Bladed	
Images				
Cross-section	Shape	Round	Round	Ellipse / Oblong
	Dimensions			
Material	Stainless steel / iron			Aluminium

3. Set the guide plate B according to the spoke type.

Turn the knob screw counterclockwise to loosen it.

Set the guide plate B as shown.

Turn the knob screw clockwise to fix the guide plate B firmly.

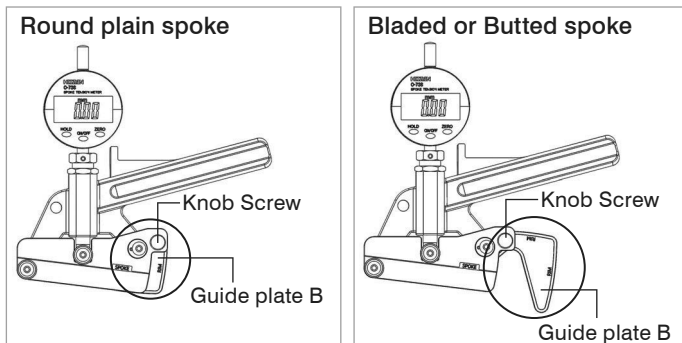

Operation

Main operation

4. Press the ON / OFF button to turn on the power.

Make sure the numbers are shown on the display.

5. Perform zero adjustment.

Press the ZERO button to set the number on the display to "0.00mm".

Gently pull and release the upper knob at several times. Zero adjustment is complete when "0.00mm" is displayed stably.



Caution May cause malfunction.



Do not pull the upper knob of the digital indicator with strong force. It will be broken.

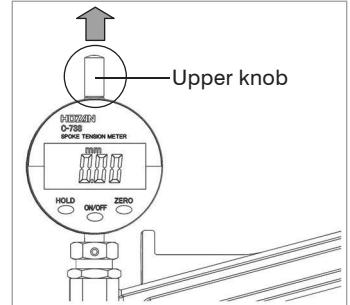

6. Place the C-738 aligning the spoke.

Hold the C-738 perpendicular to the wheel and hook the spoke by the fixed pivot of C-738.

And position the C-738 so that the spoke contact the surface of the guide plate A.

In the case if bladed spoke;

Sandwich the thinned surface between the fixed pivot and the probe. Then contact the side of the spoke with the guide plate A.

Ex.) Round plain spoke

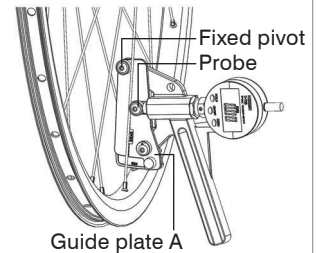

Caution May cause inaccurate measurement.



For the bladed spoke, the value changes depending on the contact direction. Align the spoke perpendicularly.

Cross-Section of Spoke

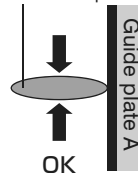

Cross-Section of Spoke

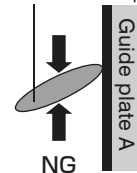

Operation

Main operation

7. Slide the C-738 until the side of the guide plate B to the position where it contacts the rim.

By making the measurement points the same, you can make stable measurement.

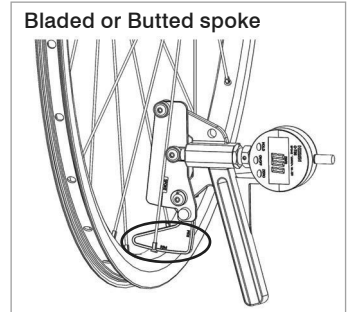
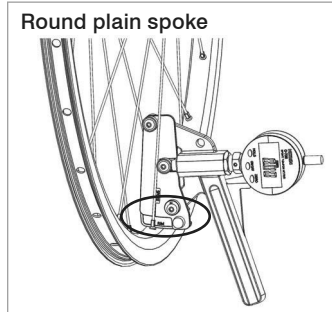

8. Hold the wheel firmly and gently press the C-738 until contacting with the stopper pin as shown.

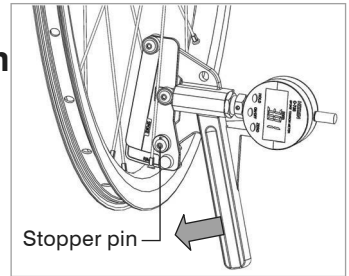

Caution

May cause inaccurate measurement.



Keep the C-738 so that the spoke contact the surface of the guide plate A.

Also, keep the C-738 so that the side of the guide plate B and the rim are in contact with each other.



Do not press more the C-738 after contacting the spoke with the stopper pin.

9. Read the measured value.

Read the measured value on the display with the spoke and stopper pin contacted.



Caution

May cause inaccurate measurement.



If the display shows a value other than "0.00 mm" when the C-738 is separated from the spokes, adjust to zero and try the measurement again.

10. Find the tension of the spoke using the conversion table.

Refer to page ❶ at the end of the instruction manual.

Daily inspection

Perform daily inspections for safe use.

Inspection items	Inspection contents	Handling
Display	Are the numbers shown on the display? Are the numbers stable?	If the numbers are not displayed or the value is not stable, replace with a new battery.

Maintenance / Storage method

Maintenance and care

- If the numbers are not displayed or the value is not stable, replace with a new battery.

Storage method



Caution

May cause injury or damage.



Keep out of reach of children.

- Keep away from high temperature, humidity and dust.
- Please store after rust prevention.
- If you do not use the C-738 for a long time, remove the battery.

Product disposal

Follow local regulation when disposing.

Specifications

Applicable Spoke Shape	Spokes with the shape, size, and material described in the conversion table.
Battery	Coin type lithium battery (CR2032) x 1 pc
Dimensions	185(W)×180(H)×70(D)mm
Weight	380g

HOZAN TOOL INDUSTRIAL CO.,LTD.
1-2-12 Saiwaicho, Naniwa-ku, Osaka 556-0021, Japan
Tel : +81-6-6567-3111 Fax : +81-6-6562-0024

C-738 Spoke tension meter Conversion table

Type	Plain		Butted		Bladed													
Guide Plate B	Close		Open		Open													
Cross-Sectional Shape	Round				Ellipse / Oblong													
Material	Stainless steel / Iron				Stainless steel / Iron										Aluminium			
	Dimensions	#12 ($\phi 2.6$)	#13 ($\phi 2.34$)	#13 ($\phi 2.3$)	#14 ($\phi 2.0$)	#15 ($\phi 1.8$)	#14/15/14 ($\phi 1.8$)	#15/16/15 ($\phi 1.6$)	0.9x1.9	0.9x2.2	1.0x2.2	1.0x2.7	1.3x2.2	1.3x2.8	1.4x2.3	1.4x2.4	1.5x3.8	Tension (N)
	4.38	4.14	3.99	3.65	3.65	3.39	3.35	3.45	3.17	2.55	2.62	2.69	2.83	3.03	3.17	3.11	3.24	3.15
	4.47	4.25	4.13	3.83	3.82	3.60	3.58	3.63	3.41	2.87	2.92	2.97	3.07	3.28	3.38	3.34	3.45	3.40
	4.54	4.33	4.22	3.97	3.95	3.77	3.75	3.78	3.59	3.11	3.15	3.19	3.27	3.46	3.53	3.51	3.60	3.58
	4.56	4.37	4.26	4.02	4.00	3.83	3.81	3.84	3.66	3.20	3.24	3.28	3.35	3.53	3.60	3.58	3.66	3.66
	4.58	4.40	4.30	4.07	4.05	3.89	3.87	3.90	3.72	3.28	3.32	3.36	3.41	3.59	3.66	3.65	3.72	3.72
Measured value	4.61	4.42	4.33	4.11	4.09	3.94	3.92	3.95	3.78	3.35	3.38	3.42	3.47	3.65	3.71	3.70	3.77	3.78
	4.63	4.45	4.36	4.14	4.13	3.98	3.96	3.99	3.83	3.41	3.44	3.48	3.52	3.70	3.75	3.75	3.82	3.82
	4.64	4.47	4.39	4.18	4.15	4.02	4.00	4.03	3.87	3.46	3.49	3.52	3.56	3.74	3.79	3.79	3.85	3.87
	4.66	4.49	4.41	4.20	4.18	4.06	4.04	4.06	3.91	3.50	3.53	3.57	3.60	3.78	3.83	3.83	3.89	3.90
	4.69	4.52	4.45	4.25	4.23	4.12	4.10	4.11	3.97	3.57	3.61	3.64	3.67	3.84	3.89	3.89	3.95	3.97
	4.71	4.55	4.48	4.30	4.27	4.16	4.14	4.16	4.03	3.63	3.67	3.70	3.72	3.89	3.94	3.94	3.99	4.02
Spoke manufacturer (reference)	-	DT SWISS	-	-	HOSHI SPOKE	-	HOSHI SPOKE	-	-	-	-	-	-	-	-	-	-	-

[Example of tension conversion]

Type: Plain, Diameter: 2mm ϕ , Spoke manufacturer: HOSHI SPOKE, Measured value: 4.09
The tension is 1000(N).

NOTE: Please refer to our website for the latest conversion table.