

C-702-13/14/15

SPOKE THREADING TOOL(#13)/(#14)/(#15)

C-702-22

SPOKE THREADING TOOL SET

Thank you for purchasing the HOZAN C-702-13/14/15 SPOKE THREADING TOOL, C-702-22 SPOKE THREADING TOOL SET. With proper care and handling, this fine instrument will provide years of trouble-free operation. Please read this entire instruction manual carefully before attempting to place this instrument in service. Please keep this instruction manual available for reference.

Identification of parts

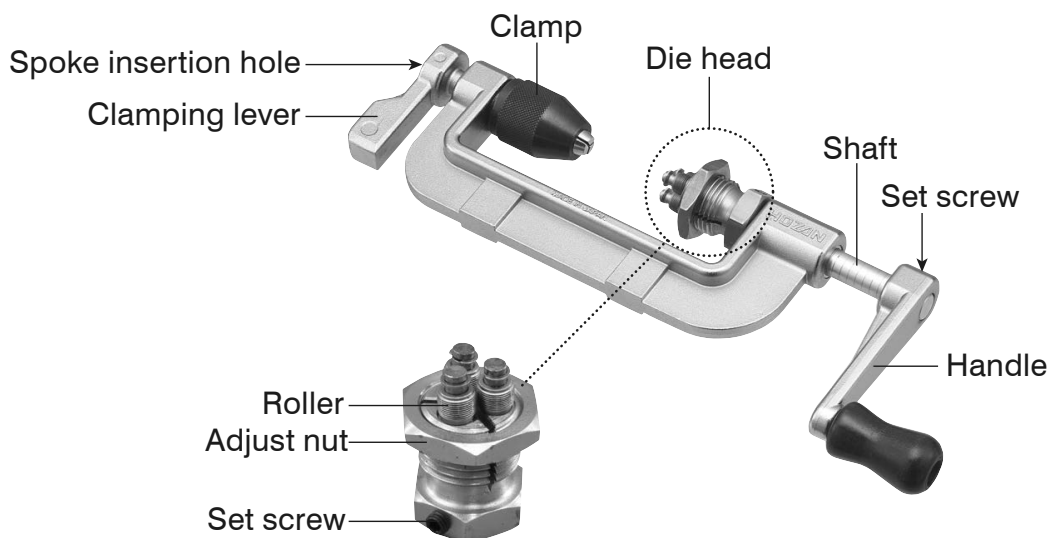

Specifications

Product number	C-702-13	C-702-14	C-702-15
Appurtenance die head	C-707-13	C-707-14	C-707-15
Thread size	BC2.3 (56TPI)	BC2.0 (56TPI)	BC1.8 (56TPI)
Applicable spoke	No.13	No.14	No.15
Applicable spoke shape	Round		
Applicable spoke length	Over 90 mm		
Applicable spoke material	Stainless steel / Steel / Titanium		
Dimensions	230(W) x 85(H) x 31(D) mm		
Weight	400 g		

C-702-22 consists of the body and the three die heads. Refer to the left table for specifications.

Note:

Do not process different sized thread than specified on each spoke.

Warning and caution symbols

These symbols are used throughout the instruction manual to alert the user to potential safety hazards as follows :

 **Warning** ... Notice when incorrect handling could cause the user's death or serious injury.

 **Caution** ... Notice when incorrect handling could cause injury to the user or material damage.

Even if the instructions do not have  **Caution** mark, there are some possibilities for a serious situation. Follow the instructions. he instructions.

Precautions

Caution

- 1 Maintain proper posture when using this tool.
- 2 Wear goggles when using this tool.
- 3 Do not modify this tool.
- 4 Do not use when cracks, breaks, wear or deformation is found on this tool.
- 5 Keep applicability of spoke size and die head.
- 6 Periodically lubricate the die head and all moving parts.
- 7 The die head is consumable. The degree of wear will vary depending on the frequency of use.
- 8 Use this tool securing in a vise. The vise must be fixed securely to the workbench.
- 9 Do not tighten any of the adjust nuts more than necessary.
- 10 The die head is packed in an anti-rust bag. Please store the die head in this yellow bag after use.

Operation

* When using the C-702 for the first time, practice the following procedure using a discarded spoke until you are familiar with this device.

Prepare a bench vise and a 2.5 mm hex wrench.

- 1 Fix this tool on a vise firmly by the clamping sections.

Caution

Use the vise in the state fixed on the workbench securely.

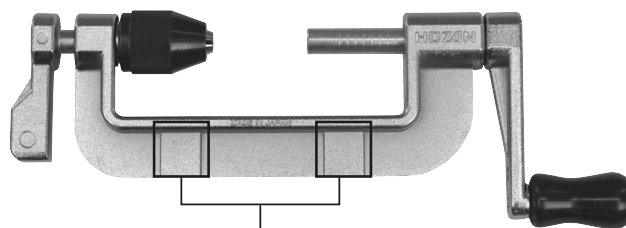

Clamping sections

- 2 Attach the die head applicable to the spoke to be worked on the body



Designation marking

Designation	Spoke sizes		Die head Part numbers
	Size	Thread size	
#13	2.3 mm ϕ	BC2.3	C-707-13
#14	2.0 mm ϕ	BC2.0	C-707-14
#15	1.8 mm ϕ	BC1.8	C-707-15

Please purchase applicable die heads separately if you do not have them.

Operation

Inset the die head into the shaft after the set screw is loosened enough.

Turn the die head set screw clockwise with the 2.5 mm hex wrench aligning the set screw and the cavity on the shaft to secure the die head.

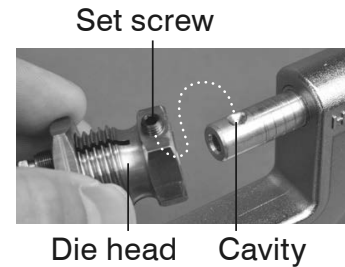

- 3** Cut the spoke to the desired length.
If cutting edge appears as indicated by NG, reform the tip of spoke with a file as indicated by OK.
There is no problem to cut on the middle of existing threads.

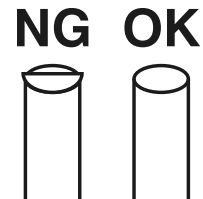

- 4** Set the spoke in this tool.
Open the clamp by turning the clamp lever counterclockwise a few revolutions.
Insert the spoke into the spoke insertion hole.

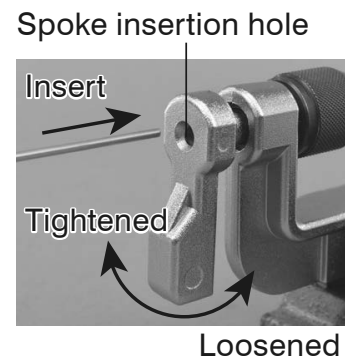

Turn the clamp lever clockwise to fix the spoke.

- Locate the spoke at the center of three jaws.

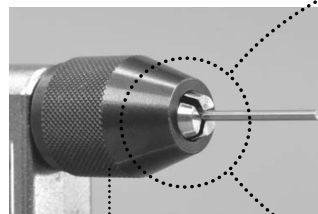

Do not rotate the clamp.

NG



Missed the center

OK

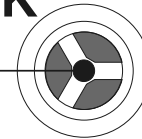

Centered

- The tip of the spoke must reach to the position explained by the dotted line in the photo.

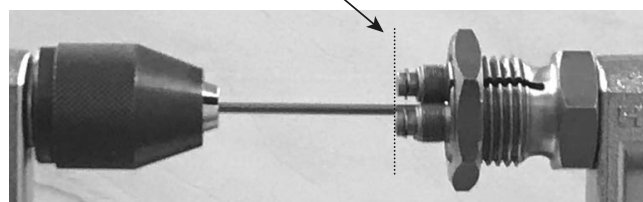

Operation

- 5** Slide the handle slightly toward the spoke so that the tip of spoke contacts with the center of three rollers of the die head.



- 6** Lubricate the rollers with cutting oil, and then turn the handle clockwise slowly while depressing slightly against the spoke to make the thread. When confirming the die head bites the spoke, stop pressing but continue to turn the handle clockwise until the thread becomes a necessary length.

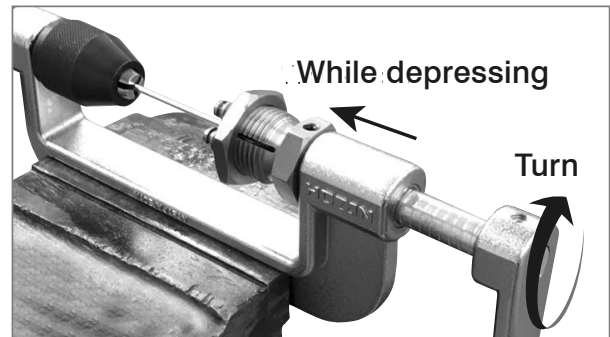

The shaft is notched at intervals of 3 mm. Please utilize as the scale for thread length.

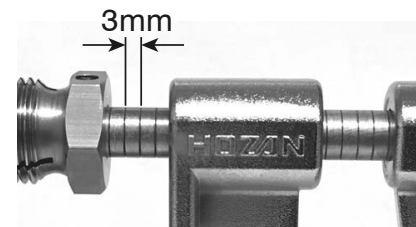

⚠ Caution

Do not turn the handle after contacting with the body. Otherwise, this could break the thread, spoke and this tool.

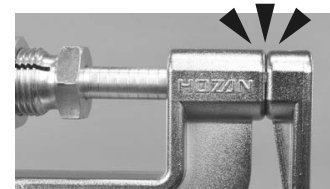

- 7** When desired length of thread is made, turn the handle counterclockwise to separate the die head from the spoke. Turn the clamp lever counterclockwise and draw the spoke out.

- 8** Inspect the processing result. Insert the nipple to be used into the spoke. If you can not insert the nipple smoothly, the die head condition must be adjusted. Refer to 'Die head adjustment' on next pages.

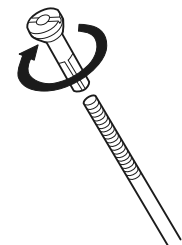

⚠ Caution

If looseness is found on set screws as photo, please tighten as necessary with the 2.5 mm hex wrench.

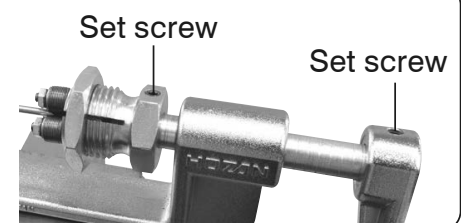

Die head adjustment

The die head is adjusted to the prescribed size at the time of shipment. However you may need to adjust the die head due to wear of parts of die head or the allowance of spoke diameter. When you adjust the die head, please refer to the following procedures.

1 Prepare a discarded spoke applicable to the die head to be adjusted, a vise, a 27 mm wrench and a 2.5 mm hex wrench.

2 Using the 2.5 mm hex wrench, turn the set screw counterclockwise to remove the die head.



3 Clamp the die head with the bench vise.

⚠ Caution

- Do not adjust the die head while attaching it to the body.
- Avoid clamping the die head by its plane which has the set screw.

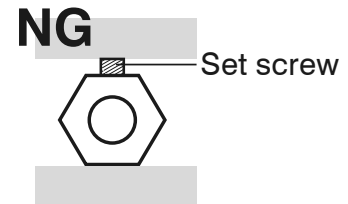

4 Lubricate around the adjust nut with enough osmosis lubricant or lubricating oil.

⚠ Caution

If using without lubrication, it may break the die head due to friction.

5 Turn the adjust nut with 27 mm wrench to adjust the die head

- When you cannot insert the nipple smoothly
⇒ Turn the adjust nut clockwise to tighten
- When the die head does not bite the spoke
⇒ Turn the adjust nut counterclockwise to loosen

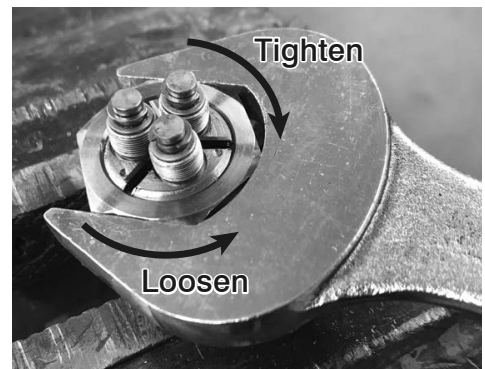

* Please adjust gradually. Turn about 30 degrees at a time inspecting fit condition.

Die head adjustment

- 6 Attach the adjusted die head to the main body.
- 7 Process an actual spoke according to “Operation” (page 2—4) and inspect fit condition with the nipple.
It is completed if the nipple is inserted smoothly.
If the nipple cannot be inserted, repeat procedures from 2 to 7 until the correct threads are produced.

Die head maintenance

- Lubricate rollers with cutting oil every work.
- Clean rollers with a brush when cutting scraps remain in roller grooves.

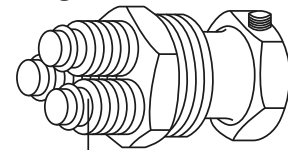

- The die head is a consumable part. Even if it is adjusted with the adjust nut, it may not be possible to roll the correct thread. In that case please replace the die head. Rollers alone cannot be replaced.
- Store the die heads wrapping with the antirust bags (original yellow polyethylene bags) or after treat with lubricant.

Replacement die heads

C-707-13 Die head

For stainless steel/steel spokes

C-707-14 Die head

For stainless steel/steel spokes

C-707-15 Die head

For stainless steel/steel spokes

HOZAN TOOL INDUSTRIAL CO.,LTD.

1-2-12 Saiwaicho, Naniwa-ku, Osaka 556-0021, Japan
Tel : +81-6-6567-3111 Fax : +81-6-6562-0024