

MORINI[®]
GROUP

Prodotto importato e distribuito da:
MORINI GROUP SRL
Martina Franca (Taranto) Italy

www.morini-group.it

Made in P.R.C.

I X B O X

shower

Installation Operation Manual

S-109T

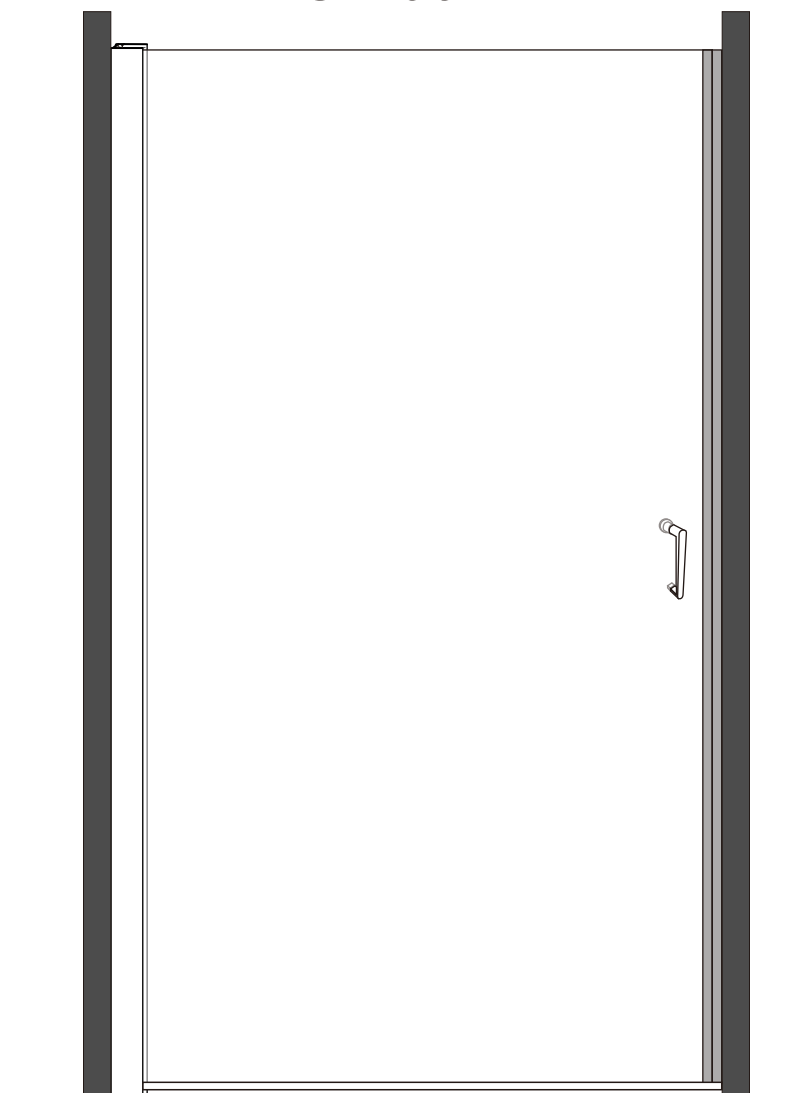

Important Reminder

1. Please install the shower enclosure according to the instruction strictly, otherwise, it will affect the operational performance.
2. After opening the carton, please check the parts according to the part list.
3. Please handle the glass parts carefully, don't knock on the glass to avoid damage.
4. After installation completely, please use it after 24 hours.

Notice

1. Do not let children, old people or disabled people enter the room alone.
2. Do not climb or hang heavy things on the shower enclosure.
3. Do not knock and impact the glass with heavy things.
4. Caution slippery on the inside of the shower enclosure.
5. Ordinary liquid detergent should be used with a soft cloth for cleaning.
6. Apply silicone to prevent water leakage.
7. Keep the tray clean, avoid hair and sundries to jam the drain.

Tools:

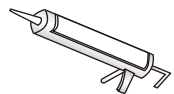

Silicone



Spirit level

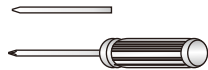

Cross screw driver

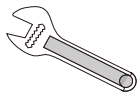

Wrench



Drill

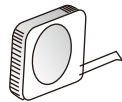



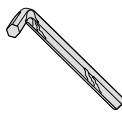



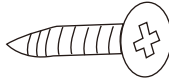

Tape measure

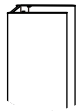
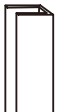

Hex wrench

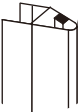
Part list:

A  Screws ST4X25 X8	B  Screws ST4X10 X4	C  Expansion screws X8
D  Aluminium alloy X1	E  Aluminium alloy X1	F  X1
G  Bottom water retaining strip X1	H  Handle X1	I  Aluminum alloy with magnetic stripe X2
J  Drill bit 3mm X1		

Installation Procedure

STEP1:

Wall profile assembling

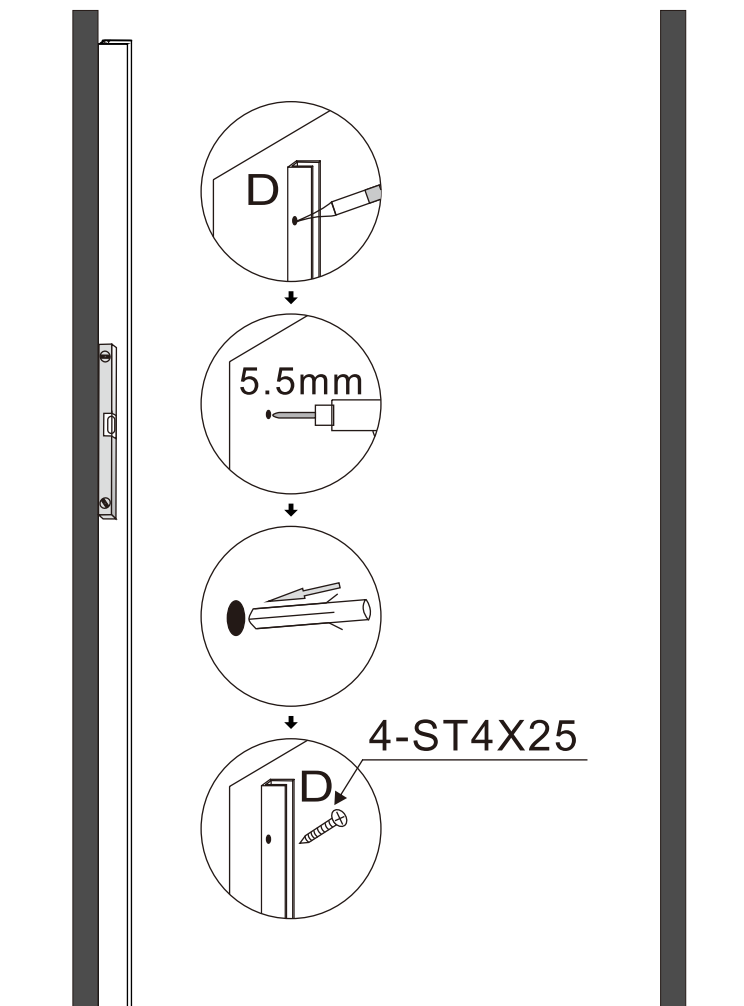

- Place the wall profile in position. Adjust the wall profile until it touches the wall.
- Mark the position of wall profile on the wall with a pencil.

3

STEP2:

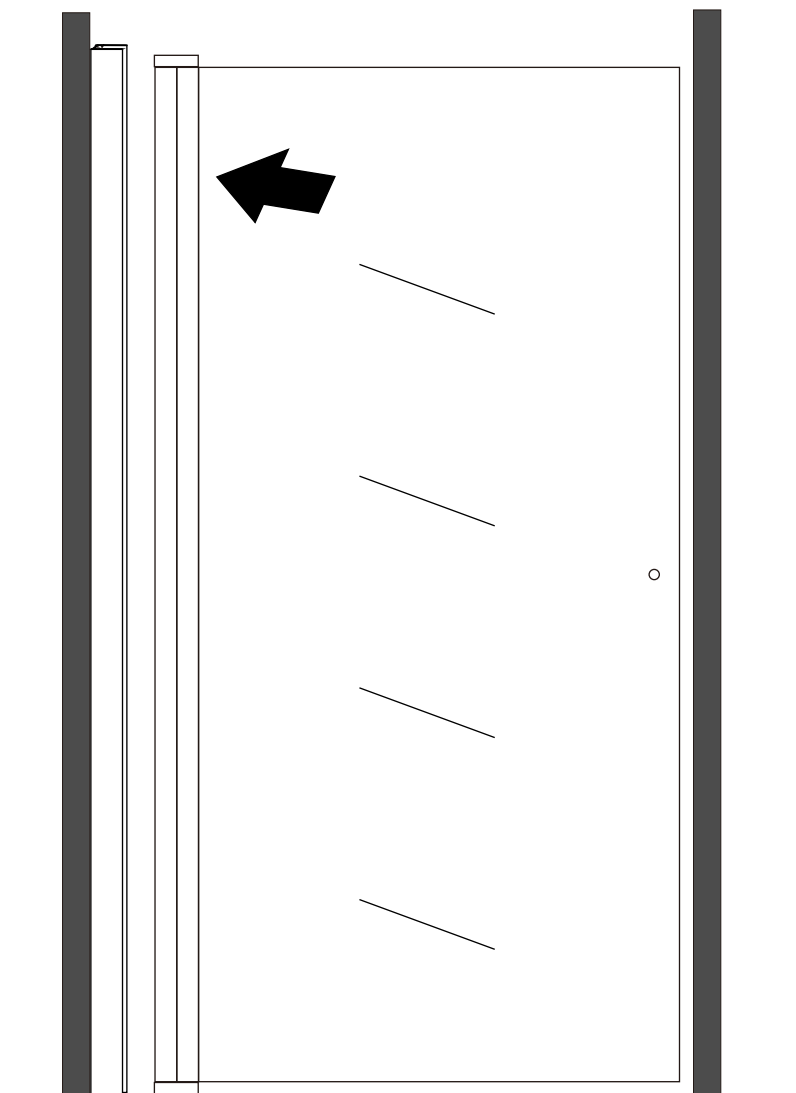

4

STEP4:

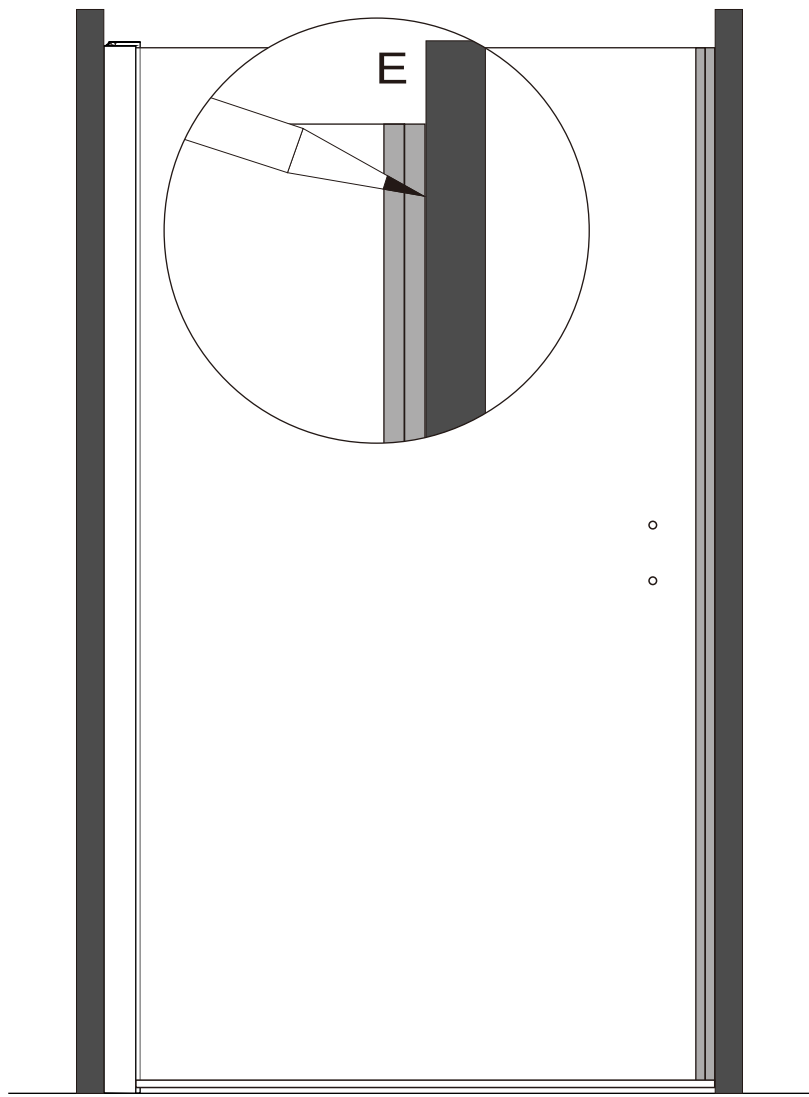

STEP5:

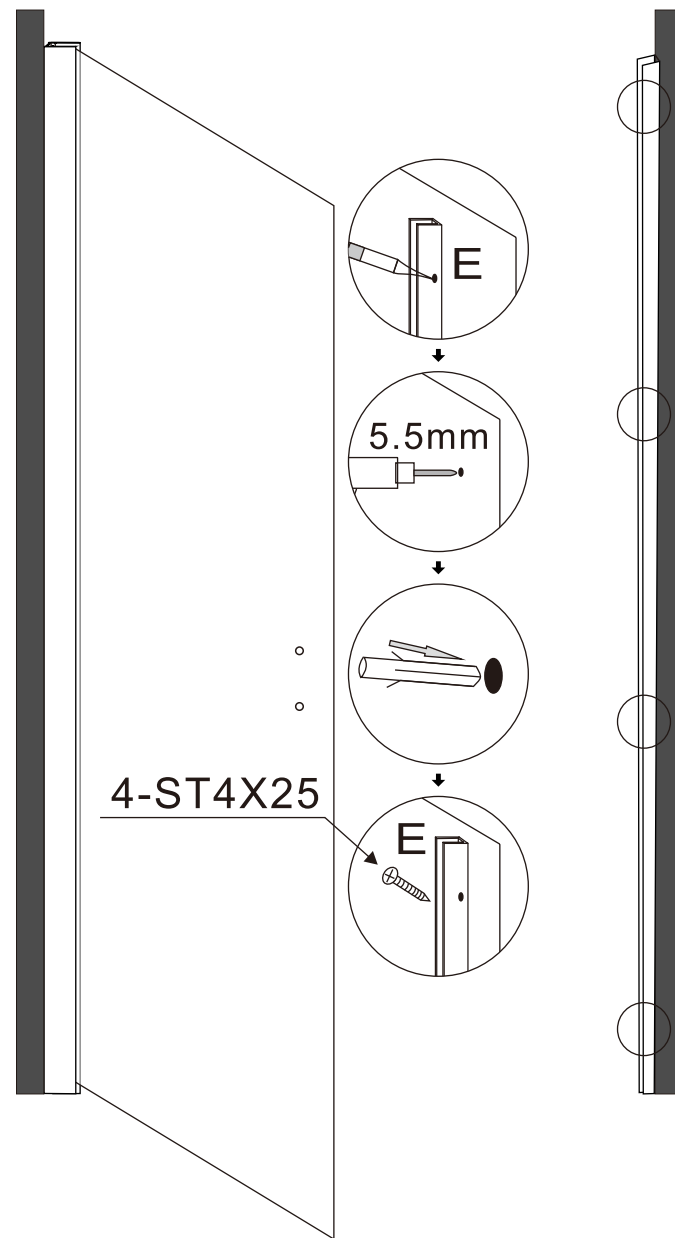

STEP6:

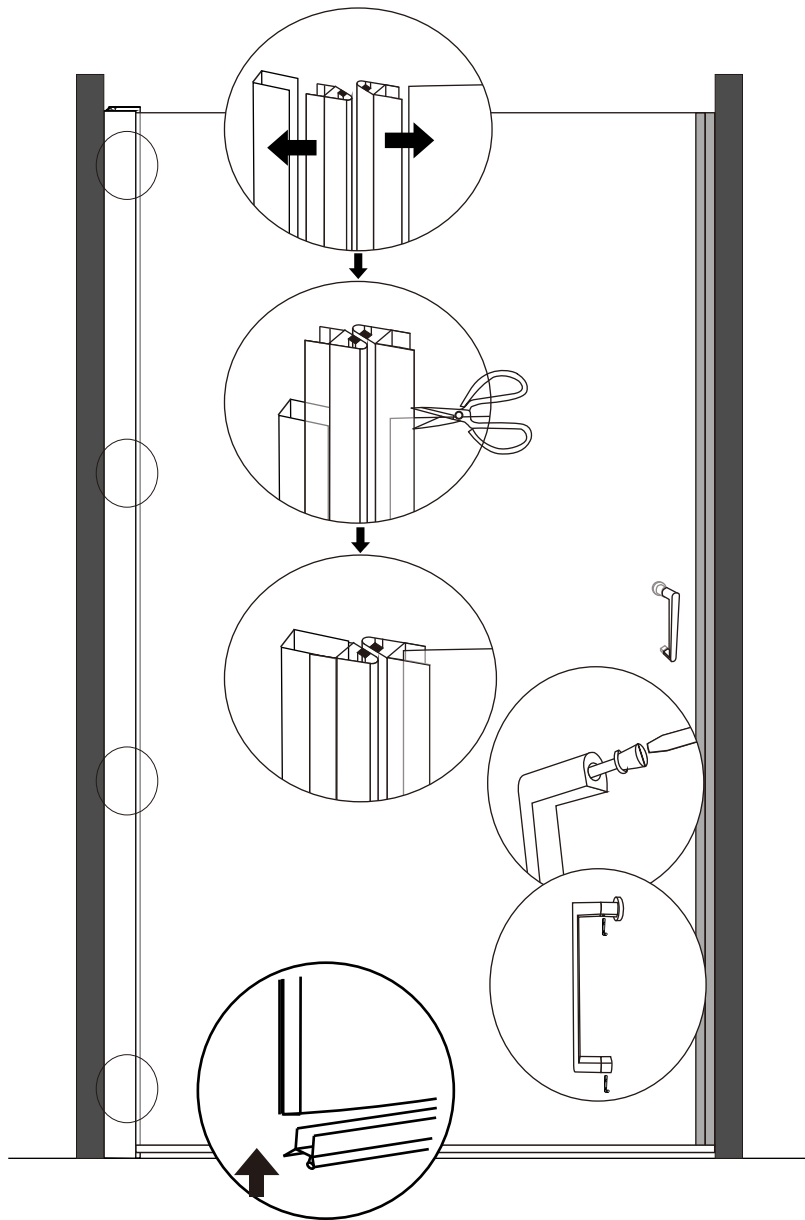

STEP7:

