

SELF-CONTAINED DIGITAL ACCESS CONTROL KEYPAD

CE



DOLKSS1KB

Programming & Installation Manual

FOR ELECTRIC LOCK INSTALLTION

Transmitter 
SOLUTIONS®

TABLE OF CONTENTS

INTRODUCTION	3
DESCRIPTION OF CONNECTION TERMINALS & INDICATORS	3-7
Connection Terminals	4
The LED Indicators	5
The Pacifier Tones & The LED Indicating Signals	5
STANDARD PROGRAMMING SUMMARY CHART	6-8
SETTING & PROGRAMMING	9-26
Criteria for Programming	9
Enter and Exit Programming Mode	9
The DAP Jumper (Direct Access to Programming Mode) – If Master Code is Forgotten	9
Programming A New Master Code	10
System Refresh (Complete Data Refresh)	10
Programming The User Codes	11
Programming The Super User Code	12-13
Programming The Visitor Codes	14
Deleting User Codes & Other Function Codes	15
Configuration of Output Modes for Outputs 1	16-17
Configuration of Output 1 for Electric Lock	18
False Attempt System Lock-up or Reporting	19
Output Activation Announcer	20
User Code Entry Modes (Auto or Manual)	20
Pacifier Tones ON-OFF	21
Main Status LED Flashing ON-OFF	21
Egress Delay & Warning	22-23
SET KEYPAD TO SINGLE USER MODE (to whom it may require)	24-25
Programming Summary Chart for “Single-User Mode”	24-25
Programming Examples for “Single-User Mode”	25
SPECIFICATIONS	26
APPLICATION EXAMPLE	27
AUXILIARY INFORMATION	28

INTRODUCTION

DOLKSS1KB is a self-contained digital access control keypad that offers field proven reliability and cost effective solutions for residential and commercial installations. It is designed for stand alone electric lock operating with 12V DC power supply. It employs a 3 Amp Solid State output contact and is virtually compatible with any Fail-safe or Fail-secure electric locking device.

DESCRIPTION OF CONNECTION TERMINALS & INDICATORS

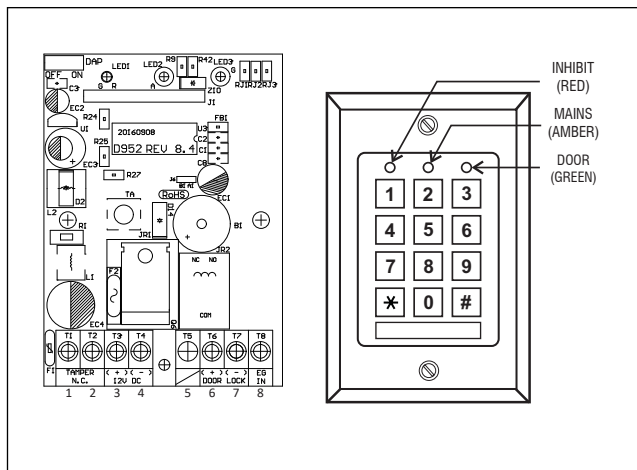

CONNECTION TERMINALS

- **1 - 2 : TAMPER N.C.**

Normally Closed contact while the keypad is secured on the box. It is open while keypad is separated from the box. Connect this N.C. terminal to a 24 hour zone of an alarm system if necessary.

- **3 - 4 : 12V DC -- POWER INPUT**

Connect to 12V DC power supply. The (-) supply, Terminal (4) is the common grounding point of the keypad. Terminal (3) is the +12V power input terminal.

- **6 - 7 : OUTPUT 1 -- DOOR LOCK**

Output 1 is controlled by the group 1 user codes. It is a 12VDC / 3 Amp rating Solid State output contact with terminal 6 (+) and terminal 7 (-) for electric door lock actuation. Connect the lock to these terminals directly with correct polarity. The output has been set for **Fail-Secure Electric Lock in Default**. It is programmable for Fail-Secure (energized to open) or Fail-Safe (de-energized to open) electric lock at programming Location 66.

The output contact is programmable for Start / Stop (toggle) mode or timer mode from 1 to 999 seconds. See programming Location 40-43 for the details.

- **8 - EG IN -- EGRESS INPUT**

A Normally Open (N.O.) input terminal refers to (-) ground, with the help of a normally open button to activate the Output 1 for the same time period as like the user code. Egress button is usually put inside the house near the door.

More than one egress buttons can be connected in parallel to the terminal. Leave this terminal open if it is not used.

THE LED INDICATORS

- **MAINS (AMBER)**

This is a status indicator. It flashes during standby and other indications in synchronization with the pacifier tones. See the chart of LED indication signals below for the details.

- **DOOR (GREEN)**

It lights up in green while output 1 is active (The door is open).

- **INHIBIT (RED)**

It lights up while output 1 is inhibited; including manually inhibited with Super User Code or due to False Code Lock-up setting in Location 70.

BACK LIGHTING

The keypad is in dim back lighting during the standby period. It gets brighter for 10 seconds on each key button press, which indicates the allowable time for succeeding code entry. The previous codes will be cancelled if no code is entered within 10 seconds.

THE PACIFIER TONES & THE LED INDICATING SIGNALS

The built-in buzzer and the MAINS LED indicator give the following tones and signals for operation status:

STATUS	TONES*	LED SIGNALS
1. In programming mode	---	ON
2. Successful key entry	1 Beep	1 Flash
3. Successful code entry	2 Beeps	2 Flashes
4. Unsuccessful code entry	5 Beeps	5 Flashes
5. DAP jumper not replaced	Continuous Beeps	Continuous Flashes
6. In standby mode	---	1 Flash in 2 seconds interval
7. Output relay activated	1 second Long Beep **	---

NOTE:

* All Pacifier Tones can be enabled or disabled through programming options at Location 83.

** The Output Activation Beep can be enabled or disabled through programming options at Location 81.

STANDARD PROGRAMMING SUMMARY CHART

A) Enter Programming Mode with Master Code (Exit-Factory Master Code: 0 0 0 0)

Entry of Master Code	Confirm	Comments
X X X X	*	Set system to Programming Mode

NOTE: Factory has put a master code **0 0 0 0** into the keypad before exit-factory, owner may take it for first time use.

B) System Refreshing – Installer Programming (Default: 8 9 0 1, Multi-user mode)

Refresh Code	Confirm	Comments
8 9 0 1	#	Clear all previously stored data and set keypad back to default values except Master Code

C) Code Entries – User Programming

1) Recording Master Code and User Codes – User Programming (No Default Codes)

Locations	User IDs	Entry of Codes	Confirm	Comments
0		4 to 8 digits	#	Owner's Master Code for setting system to programming mode
1	00 to 99	4 to 8 digits	#	100 User Codes for operating Output 1(Door Lock)

2) Recording Super User Code – User Programming (No Default Codes)

Location	Entry of Code	Confirm	Comments
4 5	4 to 8 digits	#	Owner's Multi-task User Code

3) Recording the Visitor Codes – User Programming (No Default Codes)

Location	User IDs	OperationTime	Entry of Code	Confirm	Comments
4 7	0 to 9	00 to 99	4 to 8 digits	#	10 visitor codes for operating Output 1. Operation Time: 00 = One time use only 01 to 99 = Valid within time limit of 1-99 hours

D) Configuration of Output Modes – Installer Programming (Default: Momentary, 1-second)

Location	Code of Timing	Confirm	Comments
4 0	1 to 999	#	Output 1, Momentary Mode from 1 to 999 seconds (default=1 second)
4 1		#	Output 1, Start / Stop Mode (toggle)
4 2		#	Output 1, Start / Stop Mode (toggle) with 2-digit Accelerated start code
4 3		#	Output 1, Start / Stop Mode (toggle) with 3-digit Accelerated start code

E) Configuration of Output 1 for Electric Lock – Installer Programming (Default: Fail-Secure)

Location	Type of Lock	Confirm	Comments
6 6	0	#	Fail-Secure electric lock (energized to unlock)
6 6	1	#	Fail-Safe electric lock (de-energized to unlock)

F) False Code Lock-up & Reporting – Installer Programming (Default: 10 tries / 30 seconds)

Location	Lock-up Modes	Confirm	Comments
7 0	1	#	10 successive false codes, keypad locks during 30 seconds (default)
7 0	5 to 10	#	Selectable of 5 to 10 false code, keypad locks during 15 minutes. Locking can be released at any time with Super User Code # 9
7 0	00	#	Disappearance of all the above securities

G) Output Activation (Door Open) Announcer – Installer Programming (Default: 1 long beep)

Location	Function Codes	Confirm	Comments
8 1	0	#	No notification.
8 1	1	#	2 short-beep is given when the door lock is opened.
8 1	2	#	1 second long beep notification is given when the door lock is opened. It is good for locking device give no sound when it activates. Such as a magnetic lock (default)

H) User Code Entry Modes (Auto or Manual) – Installer Programming (Default: Manual)

Location	Function Codes	Confirm	Comments
8 2	0	#	Manual Entry Mode requires to enter # button after the user codes. It is NOT necessary to set the Master Code and all User Codes in the same digit length. They can be 4-8 digits mixed arbitrary (default)
8 2	1	#	Auto Entry Mode does not need to enter # button after the user codes. However, All the User Codes MUST be in the same digit length of the Master Code and they can be 4-8 digits

I) Pacifier Tones (Key-press beeps) – Installer Programming (Default: ON)

Location	Function Codes	Confirm	Comments
8 3	0	#	Pacifier tone OFF, good for silent environment
8 3	1	#	Pacifier tone ON for every key-press (default)

J) Main LED Flashing ON-OFF – Installer Programming (Default: Flashing)

Location	Function Codes	Confirm	Comments
8 4	0	#	Main LED OFF during system standby, good for people do not like flashing LED at night
8 4	1	#	Main LED flashing during system standby (default)

K) Egress Delay & Warning – Installer Programming

(Default: Instant, No warning)

<u>Location</u>	<u>Delay Options</u>	<u>Confirm</u>	<u>Comments</u>
<input type="text" value="8"/> <input type="text" value="5"/>	0 to 4	<input type="text" value="#"/>	Five delay options for operating Output 1 with egress button: 0 – Instant activation, no delay and warning (default) 1 – Momentary contact, 5 seconds delay with warning 2 – Momentary contact, 10 seconds delay with warning 3 – Hold contact, 5 seconds delay with warning 4 – Hold contact, 10 seconds delay with warning

L) Exit Programming Mode

<u>Confirm</u>	<u>Comments</u>
<input type="text" value="*"/>	It is always necessary to set keypad back to normal operations after programming

Criteria for Programming

- (1) The keypad **MUST** be in Programming Mode for making Setting and Data Changes.
- (2) Programming can be accomplished in workshop or at the installation site. All data are stored in a non-volatile memory and will not be lost in power off.
- (3) **DO NOT** disconnect the keypad from power while in programming mode; otherwise could cause a keypad memory error.

Enter and Exit Programming Mode

It is necessary to set the keypad in programming mode with the Master Code for all programming.

1. Enter programming mode with the master code and confirm it with key.

For the owner's convenience in programming at the first time, a Master Code  has been set before exit-factory.

Master Code



Confirm



--- Keypad is now in programming mode

2. Use the programming instructions stated in "Programming Summary Chart" to make change of the keypad data. Programming can be done continuously one by one on the Locations required until finish.
3. **Exit the programming mode by pressing the  key after all the required programming is finished.**

NOTE:

- For security reason, owner should program a new master code to replace the exit-factory master code.
- Once a new master code is programmed, the old master code is replaced.
- Use DAP jumper to set keypad to programming mode if master code is forgotten. See DAP Jumper description for the details.

The DAP Jumper (Direct Access to Programming Mode) – If Master Code is Forgotten

If the master code is forgotten, use the DAP jumper (located on the main circuit board) to override the forgotten code and permit the keypad direct entry into programming mode. Apply the procedures precisely as follows.

1. Disconnect the power supply.
2. Move the DAP jumper from OFF to ON.
3. Reconnect the power supply.
The keypad will start beeping.
4. Move the DAP jumper back to OFF position.
The keypad will stop beeping as soon as the jumper is removed.
5. The keypad is now in the programming mode, ready to receive new programming data.
6. Re-program the keypad with the available options shown on the "Programming Summary Chart".

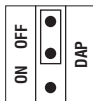

- The operation of DAP jumper is for setting the keypad into programming mode only. It does not affect the stored data in the programming locations.
- After the keypad is in programming mode, a new master code may be programmed to replace the one that was forgotten.

<u>Location</u>	<u>New Master Code</u>	<u>Confirm</u>
0	X X X X	#

NOTE:

- Location 0 is the storage location for the master code.
- The master codes can be 4-8 digits long.
- User codes must have the same length as the master code if the keypad is in auto code entry mode.

Programming Example :

1. Set keypad to programming mode with master code and * key or DAP jumper. Taking the factory-set master code 0000 as example here:

0 0 0 0 *

2. Program a new Master Code 3 2 8 9 for the keypad:

0 3 2 8 9 #

3. Exit programming mode by pressing the * key.

NOTE:

- The keypad has a new master code 3 2 8 9 now.
- The owner can use the new master code to set the keypad into programming mode in the future and does not require to use DAP jumper every time.

System Refresh (Complete Data Refresh)**(Refresh Code 8901)**

Sometimes it may require to completely erase all the current data in memory (except the master code) and set the keypad back to its default values as like a new unit. This may be necessary while the stored data can not be traced or for a new owner who bought a house with a keypad installed. The procedures are as follows:

1. Set keypad to programming mode with master code and * key. Taking the previous programmed master code 3 2 8 9 as example here:

3 2 8 9 *

2. Enter the system refresh code and confirm with # key to clear all the current stored data except the Master Code:

8 9 0 1 #

3. Enter the required new data for the keypad. See “Programming Summary Chart” for the available data.
4. Exit programming mode by pressing the * to make keypad back to normal operation mode after all the required data are entered.

NOTE:

- The keypad is in Manual Code Entry Mode (default) after refreshing.

One group of user codes can be programmed to operate output 1 for door open. The following are the programming procedures.

	<u>Locations</u>	<u>User ID</u>	<u>Entry of Code</u>	<u>Confirm</u>
Output 1	1	00 - 99	4 - 8 Digits	#

NOTE:

- Location 1 is the storage place for the User Codes for Output 1.
- 100 unique User IDs **00-99** for 100 User Codes.
- The user codes can be 4-8 digits long in manual code entry mode; but must have the same length as the master code if the keypad is in auto code entry mode.
- See “Programming Summary Chart” Section C – 1 for more information
- See information on **Location 82** concerning digit length in Auto and Manual code entry modes.

Programming Example :

1. Set keypad to programming mode with master code and * key. Taking the previous programmed master code **3 2 8 9** as example here:

3 2 8 9 *

2. Program an User Code **8 3 2 1** for output 1 ----- One of the 100 user codes (user ID: 00-99, taking ID = 01 as example):

1 0 1 8 3 2 1 #

3. Exit programming mode by pressing the * key

Operation (Manual Code Entry Mode)

Press 8 3 2 1 # ----- Output 1 activates (The door is open)

NOTE:

In Auto Code Entry Mode only the User Codes that have the same digit length as the master code are valid and press the # key is not required.

Super User Code is a multi-task user code for activating the output 1 and operating the special functions of Output 1.

<u>Locations</u>	<u>Super User Code</u>	<u>Confirm</u>
4 5	4 - 8 Digits	#

NOTE:

- The super user code can be 4-8 digits long in manual code entry mode; but must have the same length as the master code if the keypad is in auto code entry mode.
- Super user code and Egress Button are excluded from any system operation inhibit and lock-up; they are always valid for door open at anytime for safety.
- See “Programming Summary Chart” Section C – 2 for more information
- See information on **Location 82** concerning digit length in Auto and Manual code entry modes.

Programming Example :

1. Set keypad to programming mode with master code and * key. Taking the previous programmed master code **3 2 8 9** as example here:

3 2 8 9 *

2. Program **2 5 8 0** as Super User Code:

4 5 2 5 8 0 #

3. Exit programming mode by pressing the *

Operation :**1) Operating Output 1**

Super User Code is just like a normal user code. Simply key-in the code with a specific output number of the desired output. Super User Code can also be used to reset an output operating with long timer instantly at anytime required.

2 5 8 0 # 1 ----- Output 1 Activates or De-activates

2) Overriding The Door Lock Controlled by Output 1 (Keep Door Un-locked)

The Output 1 is usually for door lock control. In some circumstances, the door lock may be required to be un-locked for a period for people to enter-exit the premises conveniently without user code. The function Starts / Stops in toggle with the following code entry.

2 5 8 0 # 7 ----- The Door is Un-locked, Start-Stop in Toggle

NOTE:

- The “Output 1” LED (Green) turns ON while the door is un-locked.
- DO NOT forget to stop this function after its use is no longer required.
- **This feature is recommended for Fail-safe locks only.**
- **Fail-secure lock is NOT recommended, which may be damaged by staying activated for too long due to high power consumption.**

REMARK :

While **SUPER USER CODE # 7** is in operation to hold the door lock open, all the User Codes including Super User Code for Output 1 are temporarily suspended.

3) Inhibiting The User Codes for Output 1 (Manually Disable All User Codes for Door Lock Actuation)

To enhance security after office hour or while nobody inside house, owner can manually stop the operation of Output 1 to prevent users from accessing the protected premise with user codes. The function is Start-Stop in toggle with the following code entry.

2 5 8 0 # 9 ----- Door Lock Operation Disabled, Start-Stop in Toggle

NOTE:

- Inhibiting applies to all the user code for Output 1 only.
- For safety reasons, the egress button and the super user code continue to operate the output 1 even output 1 is inhibited.
- The INHIBIT LED is ON while output 1 is inhibited.

Visitor Codes are temporary user codes that can be assigned to visitors or temporary workers to activate Output 1 (usually for door lock actuation). They can be programmed for **One-Time** use or with **Time-Limit** in a valid duration.

Locations	User ID	Valid Duration	Entry of Code	Confirm
4 7	0 - 9	00 or 01 to 99	Visitor Code	#

NOTE:

- Visitor codes can be 4-8 digits long in manual code entry mode; but must have the same length as the master code if the keypad is in auto code entry mode.
- 10 unique User IDs **0-9** for 10 Visitor Codes.
- Valid Duration:
 - 0 0 --- One-Time Code – It has no time limit but can only be used ONCE by visitor, after which it is automatically cleared.
 - 0 1 to 9 9 --- Time-Limit in Hour – Set the duration the visitor codes will be valid, from 1 to 99 hours.
- All Visitor Codes will be deleted after power lost.
- See “Programming Summary Chart” Section C – 4 for more information.
- See information on **Location 82** concerning digit length of the code in Auto and Manual code entry modes.

Programming Example :

1. Set keypad to programming mode with master code and  key. Taking the previous programmed master code **3 2 8 9** as example here:

2. Program a Visitor Code **1 3 7 8** at ID “0” for One-Time use:

3. Program a Visitor Code **2 3 0 8 9** at ID “1” with Time-Limit of 5 hours:



4. Program a Visitor Code **8 3 5 8** at ID “2” with Time-Limit of 10 hours:

5. Exit programming mode by pressing the 

Operation :

1. Activate Output 1 with the One-Time Visitor Code:

     ----- The code is cleared after use

2. Activate Output 1 with the 5 hours Time-Limit Visitor Code:

      ----- Un-limited use within 5 hours





3. Activate Output 1 with the 10 hours Time-Limit Visitor Code:

     ----- Un-limited use within 10 hours

To delete a user who has left the company or who no longer has the authority to enter the protected area.





Deleting Examples:

1. Set keypad to programming mode with master code and  key. Taking the previous programmed master code **3 2 8 9** as example here:

2. Deleting the codes one by one if more than one codes are required. Enter Location number and User ID (if has) and the  key:

- a) Delete a User Code from ID 01 from Output 1, press Location 1, User ID 01 and  key:

- b) Delete the Super User Code, press Location 45 and  key:

- c) Delete a Visitor Code from ID 3, press Location 47, User ID 3 and  key:

3. Exit programming mode by pressing the 

The output 1 can be programmed to trigger with the following options. for a programmed length of time from 1 to 999 seconds; or to trigger ON and OFF in toggle with a user code; or to trigger ON with an accelerated start code and OFF with a full digit user code.

	Locations	Time Length	Confirm
A)	4 0	1 – 999	#
B)	4 1		#
C)	4 2		#
D)	4 3		#

NOTE:

Programming Locations:

- Locations 40, 41, 42 and 43 for Output 1

Programming Options for Output 1 (See “Programming Summary Chart” Section D for more information) :

A) Location 40 : Momentary Mode with time length from 1 to 999 seconds (Default = 1 second)

The relay outputs can be programmed to work for a time length from 1 to 999 seconds to cope with the door opening required.

B) Location 41 : Start / Stop Mode (toggle)

The relay outputs can be programmed to trigger ON (start) and OFF (stop) with a user code.

C) Location 42 : Start / Stop Mode (toggle) with 2-digit Accelerated Code

The relay outputs can be programmed to trigger ON with only the first 2 digits of a user code and OFF with a full user code.

Example:

- User Code **8 3 2 1** is a full code, then the first 2 digit **8 3** is the accelerated code.
- User Code **5 4 3 2 1** is a full code, then the first 2 digit **5 4** is the accelerated code.

D) Location 43 : Start / Stop Mode (toggle) with 3-digit Accelerated Code

The relay outputs can be programmed to trigger ON with only the first 3 digits of a user code and OFF with a full user code.

Example:

- User Code **5 4 3 2 1** is a full code, then the first 3 digit **5 4 3** is the accelerated code.
- User Code **9 2 7 0 5 3** is a full code, then the first 3 digit **9 2 7** is the accelerated code.

Programming Examples:

1. Set keypad to programming mode with master code and ***** key. Taking the previous programmed master code **3 2 8 9** as example here:

3 2 8 9 *****

2. Set Output 1 in momentary mode of 5 seconds:

4 0 5 **#**

3. Set Output 1 in Start / Stop Mode:

4 1 **#**

4. Set Output 1 in Start / Stop Mode with 2-digit Accelerated Start Code:

4 2 **#**

5. Exit programming mode by pressing the *****

Operation :

1. Operate Output 1 in momentary mode of 5 seconds using user code **8 3 2 1** that was programmed previously:

8 3 2 1 **#** ----- Output 1 operates for 5 seconds

2. Operate Output 1 in Start / Stop mode using user code **8 3 2 1** that was programmed previously:

8 3 2 1 **#** ----- Output 1 start / stop in toggle with the same user code

3. Operate Output 1 in Start / Stop mode with the 2 digit Accelerated code using user code **8 3 2 1** that was programmed previously:

8 3 **#** ----- Output 1 starts with Accelerated Code

8 3 2 1 **#** ----- Output 1 stops with Full User Code

NOTE:

- **The purpose of the accelerated Code** -- Start / Stop mode with accelerated code can be considered as two user codes with one for starting and the other for stopping the output. Owner can give the accelerated code to the staff to start a system (for example, an alarm system). The staff can only start the system but can not stop it. Only the owner can stop the system with the full user code.
- The Super User Code is always valid to Start / Stop the output.

Super User Code **#** **1** ----- Output 1 Activates or De-activates

There are two types of electric door locks on the market. They are Fail-Secure and Fail-Safe. It is necessary to select the right one for your application environment. The keypad has been designed compatible with both types of lock with an appropriate code of the type of lock.

<u>Locations</u>	<u>Type of Lock</u>	<u>Confirm</u>
6 6	0 or 1	#

Programming Codes for Type of Locks:

- 0 -- Fail-Secure Electric Lock --- It is normally **de-energized** (OFF) to lock, power ON to unlock (security first) (**Default**).
e.g. Fail-secure Electric strike locks etc.
- 1 -- Fail-Safe Electric Lock --- It is normally **energized** (ON) to lock, power OFF to unlock (safety first).
e.g. Electro-magnetic locks, Drop bolt locks, Fail-safe Electric strike locks etc.

Important Note to Installer:

It is necessary to confirm that the lock is Fail-Secure or Fail-Safe before setting the type of lock for it. Wrong setting a Fail-Secure electric lock to normally energized operation may cause damage to the lock or even the keypad; because the Fail-Secure electric lock usually takes high current and is not suitable for normally energized operation.

False Attempt System Lock-up or Reporting

(Location 70)

The keypad can be programmed to give system lock up or to report the event in order to secure the premises against unauthorized entry of multiple false codes are entered. The lock-up options are represented by a 1 or 2 digits code for owner's selection.

<u>Locations</u>	<u>Lock-Up Options</u>	<u>Confirm</u>
7 0	1 to 2 Digits	#

Programming Codes for Lock-Up Options:

1 -- After 10 successive false attempts using incorrect user codes, the keypad will lock for 30 seconds (**Default**).

5 to 1 0 -- After 5 to 10 successive false attempts using incorrect user codes, the keypad will lock for 15 minutes. The lock-up can be terminated at any time with Super User Code during the locking period if required.

Super User Code # 9

0 0 -- No system lock-up will happen.

Programming Examples:

1. Set keypad to programming mode with master code and * key. Taking the previous programmed master code 3 2 8 9 as example here:

3 2 8 9 *

2. Set keypad to lock 15 minutes after 5 successive false attempts using incorrect user codes:

7 0 5 #

3. Exit programming mode by pressing the *

Output Activation Announcer

(Location 81)

The purpose of output activation announcer is to give a sound signal to notify the visitor outside to open the door when the lock is activated. It is good for the locking device, such as a magnetic lock that gives no sound when it is activated.

Locations

8 1

Function Options

0, 1 or 2

Confirm

#

Programming Options:

- 0 -- No output activation notification will be given when the door lock is opened.
- 1 -- The keypad will beep twice when the door lock is opened.
- 2 -- The keypad will give a one second long beep when the door lock is opened (**Default**).

User Code Entry Modes (Auto or Manual)

(Location 82)

Some users like to press # key to confirm a code entry manually to prevent the unauthorized person to easily check out the digit length of the user code; but some people do not. They prefer the keypad to check the code automatically when the last number of digit is reached. The keypad can be programmed for auto or manual user code entry modes.

Locations

8 2

Function Options

0 or 1

Confirm

#

Programming Options:

- 0 -- Manual code entry mode (**Default**), The # key must be pressed after entry of an user code to indicate the code has been entered completely. In this case, the user codes can be 4-8 digits arbitrary and they are not required to be in the same digit length of the master code.
- 1 -- Auto code entry mode, Pressing the # key is not required after entry of a user code. In auto code entry mode, all user codes must have the same number of digit as the master code. For example, if the master code is 5 digits, then all the user codes must be 5 digits as well.

Pacifier Tones ON-OFF**(Location 83)**

Pacifier tones are the beep tones from the keypad to confirm the code entry successfully or not. Pacifier tone ON-OFF does not impact the sound mode of the “Output Activation Announcer” at Location 81

Locations

8 3

Function Options

0 or 1

Confirm

#

Programming Options:

- 0 -- All pacifier tones OFF, good for place needs silent environment.
- 1 -- Pacifier tones enabled, the tones indicate operation status of the keypad; such as 1 beep for successful key entry and 5 beeps for unsuccessful code entry (**Default**).

Main Status LED Flashing ON-OFF**(Location 84)**

The status LED typically flashes while the keypad is in standby. Some people find it is annoying especially at the night time. The LED can be ON or OFF with the setting here.

Locations

8 4

Function Options

0 or 1

Confirm

#

Programming Options:

- 0 -- The status LED flashing is OFF. It is good for the people do not like a flashing light at night.
- 1 -- The status LED flashes all the time in standby mode (**Default**)

Most of the keypads mainly controls “Going In” with user codes and controls “Going Out” simply pressing an egress button. However, in some situations, providing some warning and delay are desirable before the door is open after pressing the egress button. For example, in hospitals or schools, it may be desirable to delay the egress operation and provide a warning to prevent patients or young children from easily leaving the protected area.

- An egress button programmed with egress delay & warning does not affect the normal operation of the keypad. The user codes are always the first priority to operate output 1 to actuate the door lock.
- It is not necessary to do anything if egress delay is not required. Just leave the egress button on its default setting.

<u>Locations</u>	<u>Egress Modes</u>	<u>Confirm</u>
8 5	0 to 4	#

The Five Egress Modes:

- 0 -- Momentary Contact with no warning and delay (**Default**)
Press the egress button momentarily, Output 1 activates instantly to open the door.
- 1 -- Momentary Contact with 5 seconds delay and warning beep
Press the egress button momentarily, the keypad will beep for 5 seconds before Output 1 activates.
- 2 -- Momentary Contact with 10 seconds delay and warning beep
Press the egress button momentarily, the keypad will beep for 10 seconds before Output 1 activates.
- 3 -- Hold contact for 5 seconds with warning beep
Press and hold the egress button for 5 seconds and the keypad will beep for those 5 seconds before Output 1 activates.
- 4 -- Hold contact for 10 seconds with warning beep
Press and hold the egress button for 10 seconds and the keypad will beep for those 10 seconds before Output 1 activates.

Programming & Operation Examples :

1. Set keypad to programming mode with master code and * key. Taking the previous programmed master code **3 2 8 9** as example here:

3 2 8 9 *

2. Program the egress button with 5 seconds delay momentarily mode:

8 5 1 #

Operation --- Press the egress button momentarily, the keypad will beep for 5 seconds before the door is open to warn that someone is preparing to exit the protected area.

3. Program the egress button with 5 seconds delay hold contact mode:

8 5 3 #

Operation --- Press and hold the egress button for 5 seconds. The keypad will beep for those 5 seconds before the door is Open to warn that someone is preparing to exit the protected area .

4. Program the egress button to return to default setting:

8 5 0 #

Operation --- Press the egress button momentarily, the door is open instantly without warning.

5. Exit programming mode by pressing the *

NOTE:

For safety and to avoid confusion, when a delay is programmed, please post a notice near the egress button to notify the users. Here are two example stickers for an egress button with 5 seconds momentary delay or 5 seconds press-and-hold delay.

Press The Button Momentarily
And Wait For 5 Seconds
Until The Door Is Unlocked

Press And Hold The Button
For 5 Seconds
Until The Door Is Unlocked

SET KEYPAD TO SINGLE USER MODE (to whom it may require)

This keypad also consists of a simplified version software for code entry. It is single user mode for those users only need one each user code for output 1 and the special functions.

Once the keypad is in single user mode, there is no User ID required for the codes, just simply enter the code to each Locations directly.

Single user mode is prepared for those users who need simple function and use the default values for their keypad only. Please ignore this section if it is not suitable for your application.

Important Notes:

- All user codes and master code must be 4 digits. The codes of more than 4 digits will be invalid.
- Change the master code to 4 digits before refreshing the keypad to single user mode. Otherwise, refreshing will be refused.
- Refreshing takes 2-3 seconds to complete. Do not enter any code during refreshing until 2 confirmation beeps are heard.
- The keypad will be in auto code entry mode in default after it is refreshed to single user mode.
- The keypad can be changed back to standard multi-user mode with the system refreshing code 8 9 0 1.
- Single user mode simplifies the procedures for code entry only. All programming procedures for other features are exactly the same like in multi-user mode and not affected.
- See summary chart for the “Single-User Mode” programming procedures.

Programming Summary Chart for “Single-User Mode”

A) Enter Programming Mode with Master Code (Exit-Factory Master Code: 0 0 0 0)

<u>Entry of Master Code</u>	<u>Confirm</u>	<u>Comments</u>
<input type="text" value="X"/> <input type="text" value="X"/> <input type="text" value="X"/> <input type="text" value="X"/>	<input type="text" value="*"/>	Set system to Programming Mode

NOTE: Factory has put a master code into the keypad before exit-factory, owner may take it for first time use.

B) System Refreshing to Single User Mode – Installer Programming (Default: 8 9 0 0, Single-user mode)

<u>Refresh Code</u>	<u>Confirm</u>	<u>Comments</u>
<input type="text" value="8"/> <input type="text" value="9"/> <input type="text" value="0"/> <input type="text" value="0"/>	<input type="text" value="#"/>	Clear all previously stored data and set keypad back to default values except Master Code

C) Code Entries – User Programming 1) Recording Master Code and User Codes – User Programming (No Default Codes)

<u>Locations</u>	<u>Entry of Codes</u>	<u>Confirm</u>	<u>Comments</u>
<input type="text" value="0"/>	4 digits fixed	<input type="text" value="#"/>	Owner’s Master Code for setting system to programming mode
<input type="text" value="1"/>	4 digits fixed	<input type="text" value="#"/>	User Code for operating Output 1

2) Recording Super User Code – User Programming (No Default Codes)

<u>Location</u>	<u>Entry of Code</u>	<u>Confirm</u>	<u>Comments</u>
<input type="text" value="4"/> <input type="text" value="5"/>	4 digits fixed	<input type="text" value="#"/>	Owner's Multi-task User Code

3) Recording the Visitor Codes – User Programming (No Default Codes)

<u>Location</u>	<u>Operation Time</u>	<u>Entry of Code</u>	<u>Confirm</u>	<u>Comments</u>
<input type="text" value="4"/> <input type="text" value="7"/>	00 to 99	4 digits fixed	<input type="text" value="#"/>	visitor code for operating Output 1. Operation Time: 00 = One time use only 01 to 99 = Valid within time limit of 1-99 hours

Programming Examples for "Single-User Mode"

1. Set keypad to programming mode with the Ex-factory Master Code **0000** or your Master Code if it was changed:

2. Refresh the keypad to Single-User Mode with Refreshing code **8900**:

3. Program a new Master Code **3289** for the keypad:

4. Program an User Code **8321** for **output 1**:

5. Program a Super User Code **2580**:

6. Program a Visitor Code **2308** with Time-Limit of **8 hours**:

7. Exit programming mode by pressing the

SPECIFICATIONS

- **Operation Voltage:**
12V DC, 11-15V DC
- **Operation Current:**
Quiescent - 16mA
Maximum - 50mA
- **Operation Modes:**
 - a) Multi User Mode -- 100 user codes for output 1 (user number 00-99), Auto or Manual Code Entry
 - b) Single User Mode -- 1 user code for each output and the special functions, Auto or Manual Code Entry
- **User Code Combinations:**
 - a) Single User Mode -- 10,000 (User Code fixed at 4 digits)
 - b) Multi User Mode -- Over 1 Million (User Code 4-8 digits programmable)
- **Input Sensing Terminals:**
Egress Input -- Normally open referring to (-) ground
- **Output Contacts:**
OUTPUT 1 : Solid State Fail-secure or Fail-safe, 3A / 12VDC. Rating
- **Tamper Switch Contact:**
Normally Closed Dry Contact, 50mA / 24VDC Max.
- **Auto Refreshing Time During Code Entry:**
 - a) Eash Digit Maximum Entry Time Limit -- 10 seconds
 - b) Eash Code Maximum Entry Time Limit -- 30 seconds
- **Operating Environment:**
In-door use only
- **Operation Temperature:**
-20°C to +70°C
- **Ambient Humidity:**
5-95% relative humidity (non-condensing)
- **Dimensions:**
117(H) X 72(W) X 42(D)mm
- **Weight:**
140g net

Specifications are subject to change for modification without notice

APPLICATION EXAMPLE

BASIC WIRINGS OF A STAND ALONE DOOR LOCK

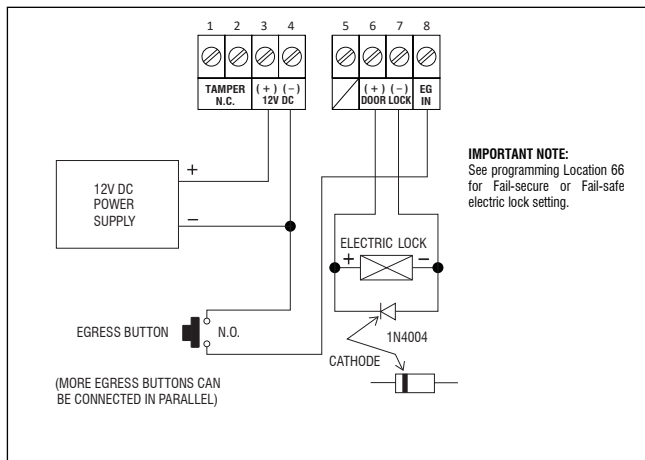

NOTE:

- Connect the 1N4004 as close as possible to the lock in parallel with the lock power terminals to absorb the back EMF to prevent it from damaging the keypad.
- To avoid Electro-Static-Discharge from interfering with the operation of the keypad, always ground the (-) GND terminal of the keypad to earth.
- The DOOR LED lights up in Green during the door lock is open.
- See programming Location 66 for Fail-secure or Fail-safe electric lock setting.

AUXILIARY INFORMATION

- **DRY CONTACT**

A dry contact means that no electricity is connected to it. It is prepared for free connections. The Relay Output contacts provided in this keypad system are dry contacts.

- **N.C.**

Normally Closed, the contact is closed circuit at normal status. It is open circuit when active.

- **N.O.**

Normally Open, the contact is open circuit at normal status. It is closed circuit when active.

- **TRANSISTOR OPEN COLLECTOR OUTPUT**

An open collector output is equivalent to a Normally Open (N.O.) contact referring to ground similar to a relay contact referring to ground. The transistor is normally OFF, and its output switches to ground (-) when active. The open collector can only provide switching function for small power but it is usually good enough for controlling of an alarm system. The Duress, Inter-lock and Key Active/Alarm Outputs of the keypad are open collector outputs.



**OPEN COLLECTOR
OUTPUT ----**

Output switches to
ground when activated

EQUIVALENT



**N.O. CONTACT
OUTPUT ----**

Output switches to
ground when activated



2480 South 3850 West, Suite B
Salt Lake City, UT 84120
(866) 975-0101 • (866) 975-0404 fax
www.transmittersolutions.com



VERSION: 170318_V1