

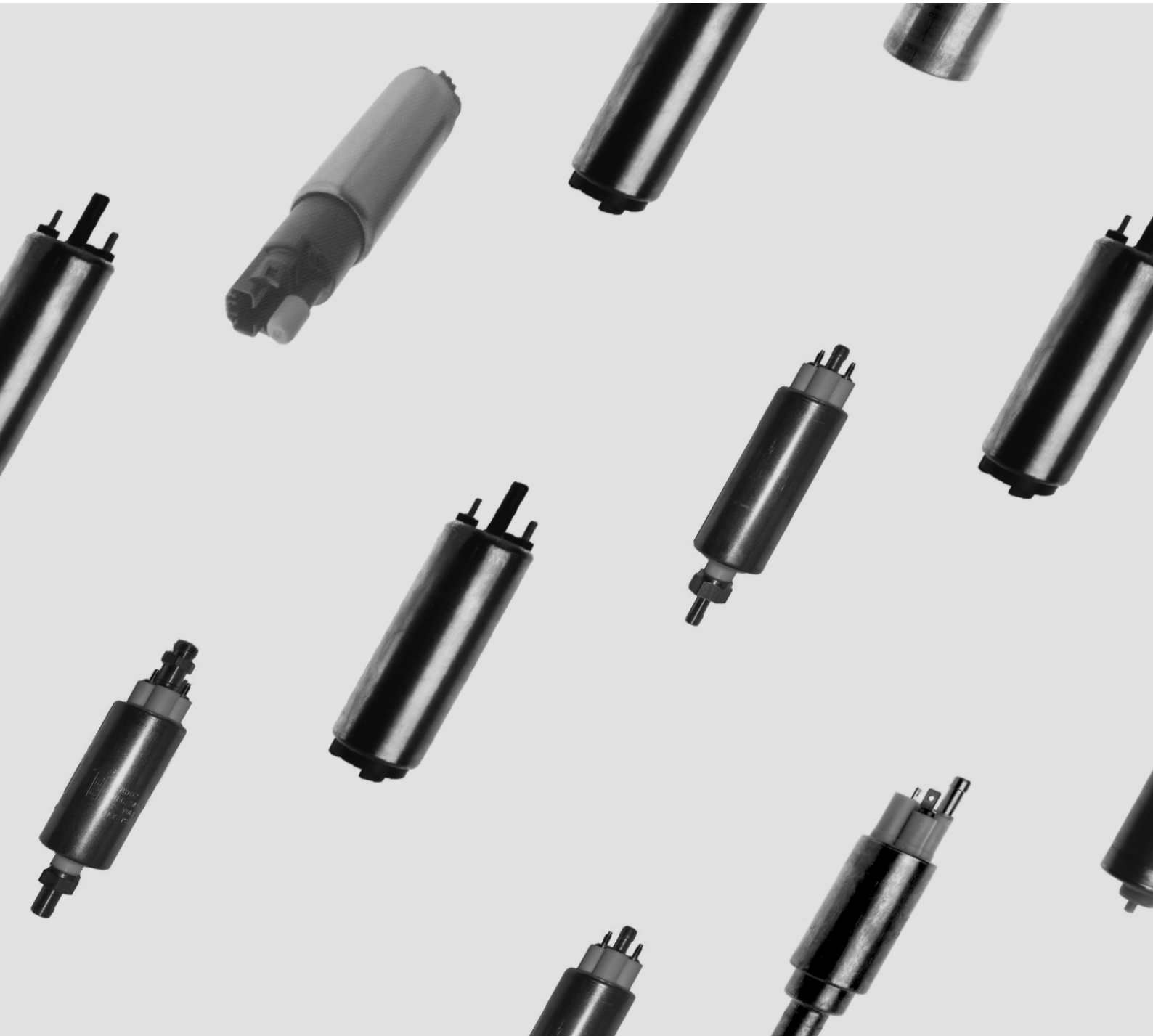

AUTOPARTS

EFI Fuel Pumps

ILLUSTRATED BUYER'S GUIDE



LOCAL SERVICE. WORLD-CLASS QUALITY.

Issue Date	August 2012
Index	Page 1
Warranty Policy and Conditions of Sale	Page 3
Fuel Pump Diagnostics	Page 4
General Installation Instructions	Page 5
Universal Low Pressure Electric Fuel Pumps	Page 6
High Performance Pumps	Page 7
Alfa Romeo, Audi, BLMC, BMW	Page 8
Chevrolet, Chrysler-Jeep USA	Page 9
Citroen, Daewoo, Daihatsu	Page 9
Daihatsu cont., Eunos, Fiat	Page 10
Ford	Page 10 - 11
Holden	Page 11 - 12
Honda	Page 12 - 13
Hyundai, Isuzu	Page 14
Jaguar / Daimler, Kia, Lexus, Marine, Marine Universal	Page 15
Mazda	Page 15 - 16
Mercedes Benz, Mitsubishi	Page 16 - 17
Nissan	Page 17 - 18
Peugeot	Page 18 - 19
Pontiac, Porsche, Proton, Renault, Rover-Landrover-Rangerover, SAAB	Page 19
Subaru	Page 19 - 20
Suzuki, Toyota	Page 21
Toyota Import Vehicles Cross Reference	Page 21 - 22
Triumph, Volkswagen, Volvo	Page 23
Fuel Pump Numerical Listings	Page 24 - 27
Fuel Pump Illustrations	Page 28 - 39

Toll Free Fax: 0800-4-CDL PARTS
(Orders Only) 0800-4-235-72787

Telephone: (09) 262-1417
Facsimile: (09) 262-1441

Street Address: 9a Earl Richardson Ave
 Manukau 2104

Postal Address: P O Box 97-146
 Manukau 2241

Email: sales@cldautoparts.co.nz

Website: www.cldautoparts.co.nz

AIRTEX FUEL PUMPS ARE TOTALLY O.E.

◆ Same Impeller Design

◆ Same Fuel-Delivery Capacity

◆ Same Motor Size

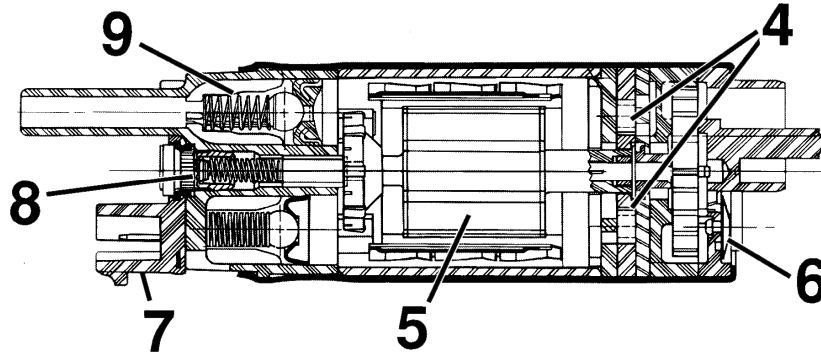

10 Reasons to Install Airtex Fuel Pumps

- 1** • The same design specified by original equipment manufacturer (O.E.)
- 2** • Performance tested to perform in most fuel blends.
- 3** • Large armature bearing surfaces.
- 4** • Metal inlet and outlet plates in pumping mechanism.
- 5** • Armature is balanced for longer life and quieter operation.
- 6** • Radio frequency filter used to eliminate buzzing in radio and car phone.
- 7** • Original equipment connecting terminals where possible. Intank pumps are complete with filter strainer supplied.
- 8** • Brush wire ends are soldered for secure connections.
- 9** • Check valve is brass bullet type with viton tip or steel ball on viton seat to minimise noise.
- 10** • All pumps test flowed after final assembly.

WARRANTY POLICY AND CONDITIONS OF SALE

Most intank EFI pumps are supplied with a primary strainer. The purpose of the primary strainer is to prevent tank contaminants entering and subsequently damaging the EFI pump. Failure to fit the supplied strainer will void any warranty claim. Please refer to page 5 for installation guidelines.

Standard EFI pumps are warranted against faulty materials and workmanship when used for their designated purpose and for a period of two years or 40,000km from date of fitment, whichever occurs first.

Non automotive applications, high performance and race car pumps such as **EP6906, EP6907, EP6966** are warranted for a period of 12 months or 20,000km from date of fitment, whichever occurs first.

Claims must be submitted in writing accompanied by the alleged faulty pump complete with strainer, proof of purchase and the following details:

1. Vehicle type
2. Fuel used i.e. 91 Octane, 96 Octane, LPG or CNG
3. Fitment date
4. Failure date
5. Kilometres travelled since date of fitment
6. Vehicle usage i.e. private, business, racing, marine

CDL Autoparts are the only automotive company in New Zealand to possess a factory approved EFI pump test rig for measuring flow and pressure. All pumps returned will be thoroughly inspected and tested, if any of the following are apparent the claim will be declined.

1. Fuel contamination
2. Use of alcohol fuel
3. Excessive use of intank fuel additives
4. Damage from unprofessional installation
5. Pump fitted to a dual fuel system and run dry

In the event of any disputes the pump will be returned to the manufacturer for evaluation, their decision will be final.

CDL Autoparts Ltd and their suppliers are the sole adjudicators on warranty claims, placement of an order is deemed to be acceptance of the conditions of sale and warranty.

Credits: Credit of items supplied as ordered by the customer will be at the discretion of CDL Autoparts Ltd.

Freight: Freight charges on returned goods will be borne by the customer and will be considered upon finalisation of the claim.

New Zealand Consumer Guarantees Act 1993:

Where the customer is a business as defined by the Act, the Consumer Guarantees Act 1993 does not apply.

Disclaimer: All care has been exercised in the research and production of this catalogue. This catalogue is designed to primarily suit the New Zealand new vehicle market. Used import vehicle applications can vary from New Zealand New specifications, therefore, due to vehicle production changes and supersessions no responsibility is accepted by CDL Autoparts Ltd for the accuracy of any information contained herein.

Copyright Notice:

© CDL Autoparts Ltd AK/114761 - CDL Autoparts Ltd is the owner of Copyright in this catalogue. This catalogue must not be reproduced in whole or in part without written authorisation from CDL Autoparts Ltd AK/114761.

EFI FUEL PUMP DIAGNOSTICS

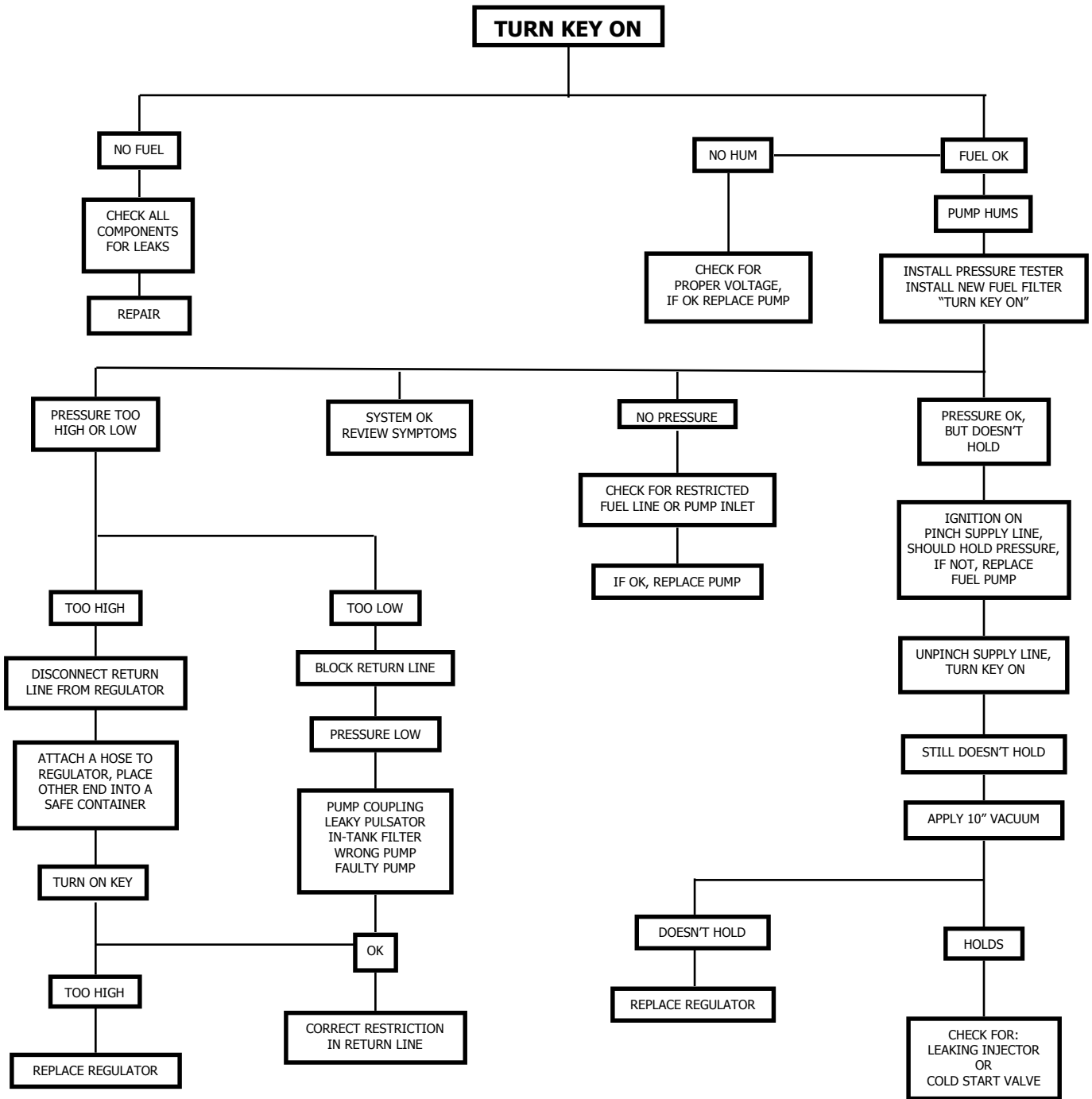

3 Common Styles of EFI Pump Elements

Roller Cell

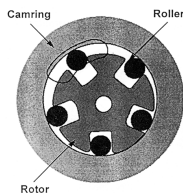

Turbine

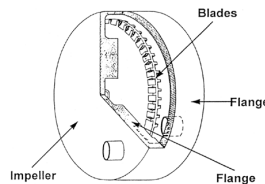

Gerotor

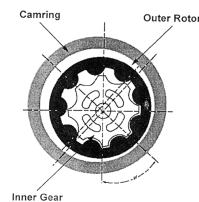

GENERAL INSTALLATION INSTRUCTIONS

INTANK APPLICATIONS - NEVER RUN PUMP DRY

1. Switch off power source to fuel pump.
2. Ensure fuel tank is close to empty, remove pump or pump sender assembly.
3. Remove fuel pump from hanger.
4. Check tank for contaminants, if any water or dirt is evident, remove tank and thoroughly clean.

Note: If the tank is badly contaminated, there is a strong possibility the fuel rail could also be contaminated and the injectors clogged.

5. Observe fitting instruction supplied with pump and fit to hanger using a new strainer.
6. Replace flange gasket, seal screws and tighten hanger flange to tank.
7. Replace inline fuel filter
8. Check system for leaks.

It is very important to replace the strainer (used) and the EFI filter when installing a new pump; failure to do so could void the manufacturers warranty.

EXTERNAL INLINE APPLICATIONS - NEVER RUN PUMP DRY

1. Switch off power source to fuel pump.
2. Ensure fuel tank is close to empty.
3. Clamp off fuel inlet line to pump, remove pump.
4. Check tank for contaminants, if any water or dirt is evident, remove tank and thoroughly clean.

Note: If the tank is badly contaminated, there is a strong possibility the fuel rail could also be contaminated and the injectors clogged.

5. Observe fitting instructions supplied with pump and fit to fuel line.
6. Replace inline EFI fuel filter.
7. Check system for leaks.

It is very important to replace the strainer (used) and the EFI filter when installing a new pump; failure to do so could void the manufacturers warranty.



UNIVERSAL LOW PRESSURE ELECTRIC FUEL PUMPS

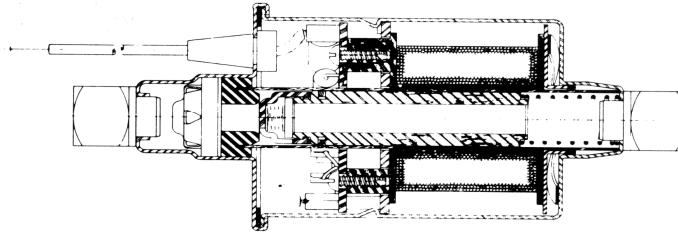

New universal solid state electric fuel pump features advanced technology.

Exclusive design provides increased vapour handling capacity. Solid state engineering has no electric contact points to wear out and it is highly resistant to voltage spikes, even reversed polarity. Permanently sealed construction with no screws to loosen or leak. Impervious to corrosion from alcohol blended fuels. Pump is filled with epoxy for maximum heat dissipation and increased protection from vibration.

Our pump is virtually indestructible!

AIRTEX SOLENOID STYLE SOLID STATE PUMPS ARE PUSH TYPE PUMPS AND WILL ONLY REACH THEIR PEAK PERFORMANCE IF MOUNTED AS CLOSE TO THE FUEL TANK AS POSSIBLE.

- | | |
|------------------|--|
| EP4006 | 24 volt, 10mm inlet-outlet with fitting kit, ideal for diesel lift pump, 6-10psi. |
| EP4010 | 24 volt, 10mm inlet-outlet with fitting kit, ideal for diesel lift pump, 10-14psi. |
| EP8011 | 6 volt, 8mm inlet-outlet with fitting kit and filter supplied. <u>Negative earth only.</u> |
| EP8012 | 12 volt, 8mm inlet-outlet with fitting kit and filter supplied, 5-9psi. |
| EP8012-38 | 12 volt, 10mm inlet-outlet with fitting kit, 9psi. Ideal for V8 applications. |
| EP8016 | 12 volt, 8mm inlet-outlet with fitting kit and filter supplied, 2.5-4psi. |
| EP8090 | 12 volt, 10mm inlet-outlet with fitting kit, 5-9psi. Heavy duty. |
| EP8153 | 12 volt, 1/4 x 18 npt inlet-outlet with fitting kit, 10-14psi. |

HIGH PERFORMANCE ROTARY SOLID DISPLACEMENT PUMPS

- | | |
|-----------------|---|
| EP84070 | 12 volt, rotary inline pump, 4-6psi, 72gph. |
| EP84389 | 12v rotary inline pump, 5-7psi, 72gph, marine application. |
| EP8845DC | 12v roller rotary inline diesel pump, 24psi, 275L/hr, open flow, carbon commutator. |

HIGH PERFORMANCE ELECTRIC FUEL PUMP FEATURES

EP6906*

EFI pump universal external inline mounting rollervane pump for high performance MPI systems. Maximum open flow 150 litres per hour. Maximum shut down pressure 8-8.5 bar, screw terminals, 8mm inlet and outlet pipes, no primary strainer supplied. Mounting brackets and hardware included, designed for leaded, unleaded or fuel blend type fuels.



EP6907*

EFI pump universal external inline mounting rollervane pump for high performance MPI systems. Maximum open flow 250-280 litres per hour. Maximum shut down pressure 7.5-8.2 bar, screw terminals, 10mm inlet and outlet pipes, no primary strainer supplied. Mounting brackets and hardware included, designed for leaded, unleaded or fuel blend type fuels.



Suitable for Hi-performance jet boat and car racing applications.

EP6966*

EFI pump universal intank mounting, 51mm body, turbine style for high performance MPI systems. Maximum open flow 340 litres per hour, maximum shutdown pressure 8.5 bar, screw terminals, 8mm outlet pipe, primary strainer included. Will supply 450 BHP at 4 bar.

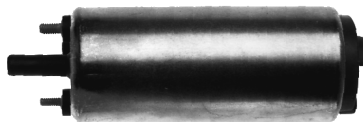

Suitable for Mazda Rotary racing applications.

****Warranty period on high performance pumps - 12 months or 20,000km***

VEHICLE APPLICATIONS

Make / Model	Series	Body	Year	Type	CC	Pump	Notes
ALFA ROMEO							
Alfa 33, Boxer			1988-1994	L4	1.7L	EP6949	
Alfa 75, Twin Spark			1985-1993	L4	2.0L	EP6949	
Alfa 75			1986-1993	V6	2.5L, 3.0L	EP6949	
Alfa 90			1984-1993	V6	2.5L	EP6949	
Alfetta GT GTV			1978-1987	L4	1.8, 2.0L	EP6949	
Alfa GTV6			1980-1987	V6	2.5L	EP6949	
AUDI							
5E			1978-1982	L5	2.1L	EP6944	
80			1978-1994	L4	1.6, 1.8, 2.0L	EP6948	
80			1992-1996	L5	2.3L	EP6915	
90 Quattro			1989-1992	L5	2.3L	EP6915	
100			1983-1991	L5	2.2, 2.3L	EP6915	
100 Quattro			1985-1989	L5	2.2L	EP6944	
200			1989-1991	L5	2.1L	EP6915	
A3			1997-2005	L4, V6	1.6, 1.8, 2.6, 3.2L	EP7927	
A4			1995-2004	L4, V6	1.8, 2.0, 2.4, 2.8L	EP7926	
A6			1994-2002	V6, V8	2.4, 2.8, 3.2, 4.2L	EP7926	
BLMC							
Maestro			1984>	L4	2.0L	EP6949	
BMW							
316i	E36		1990-1999	L4	1.6L	EP6979	GM Style Pump 37mm
318	E30		1988-1991	L4	1.8L	EP6980	GM Style Pump 37mm
318	E36		1993-1999	L4	1.8, 1.9L	EP6979	Replaces Bosch & VDO Pumps
318i	E21		1980-1982	L4	1.8L	EP6944	
318i	E30		1983-1987	L4	1.8L	EP6949	
320	E36		1991-1995	L6	2.0L	EP6979	Replaces Bosch & VDO Pumps
320i	E30		1976-1978	L6	2.0L	EP6945	
320i	E30		1982-1986	L6	2.0L	EP6949	
323	E30		1987-1996	L6	2.3L	EP6980	Delco Style Pump 37mm
323	E36		1997-1999	L6	2.5L	EP6979	Replaces Bosch & VDO Pumps
323i	E21		1979-1982	L6	2.3L	EP6944	
325	E36		1991-1996	L6	2.5L	EP6979	Replaces Bosch & VDO Pumps
325	E46		2000>	L6	2.5L	EP7928	
325i	E30		1985-1989	L6	2.5L	EP6949	
328	E36		1995-1999	L6	2.8L	EP7929	
328	E46		1999-2001	L6	2.8L	EP7929	
3 Series	E46		1999-2005	L4 B20, B20A	1.8, 2.0, 2.5L	EP7942M	
520i	E20		1980-1982	L6	2.0L	EP6944	
520i	E28		1983-1987	L6	2.0L	EP6949	
525e	E28		1983-1987	L6	2.8L	EP6949	
528i	E28		1981-1987	L6	2.8L	EP6949	
535	E39		1997-1999	V8	3.5L	EP7930	
535i	E34		1985-1987	L6	3.5L	EP6949	
535i	E36		1988-1996	L6	2.5L	EP6979	
540	E34, E39		1993-2003	V8	4.0, 4.4L	EP7930	
633 CSI	E24		1978>	L6	3.3L	EP6949	
635 CSI	E24		1986>	L6	3.5L	EP6949	
728i	E28		1979-1987	L6	2.8L	EP6949	
730i	E32, E38		1988-1996	L6	3.0L	EP6949	
735i	E32		1983-1986	L6	3.5L	EP6949	
735i	E32		1986-1993	L6	3.5L	EP6980	
740	E32		1991-1996	V8	4.0L	EP7931	
740	E38		1995-2002	V8	4.0, 4.4L	EP7930	
745	E65, E66		2001>	V8	4.4L	EP7930	
750	E32, E38		1987-2001	V8, V12	5.0, 5.4L	EP7930	
840	E31		1994-1999	V8	4.0, 4.4L	EP7930	
850	E31, E32		1989-1994	V12	5.0L	EP7945	
M3	E36		1995-1996	L4	2.3L	EP6979	Replaces Bosch & VDO Pumps
M3	E36		1997>	L6	3.2L	EP6979	Replaces Bosch & VDO Pumps
M3	E30		1985-1994	L4	2.3, 3.2L	EP6949	
M5	E34		1988-1995	L6	3.5L	EP7932	
M5	E39		1999>	V8	5.0L	EP7930	
X5	E53		1999>	V8	4.6L	EP7933	
Z3	E36, E37		1996-2003	L4, L6	2.0, 2.8, 3.0L	EP7928	

VEHICLE APPLICATIONS

Make / Model	Series	Body	Year	Type	CC	Pump	Notes
CHEVROLET							
Blazer-GMC	C10		1986-1994	V6	176-262CID	EP6950	
Blazer-GMC			1987-1994	V8	305-350CID	EP6950	
Blazer	S10		1997-2002	V6	262CID	EP6993M	2 Door Only
Blazer	S10		1998-2002	V6	262CID	EP6992M	4 Door Only
Camaro			1985-1992	V6	189CID	EP6903	
Camaro			1985-1992	V8	305/350CID	EP6903	
Camaro			1996-1997	V8	350CID	EP6991M	Intank Module
Caprice			1987-1992	V8	305/350CID	EP6903	
Corvette			1985-1991	V8	350CID	EP6923	
Corvette			1992>	V8	350CID	EP6967	
Silverado 1500, 2500, 3500			1999-2004	V6	4.3L	EP7978M	With Evap Emm. 2 plugs, Code TCF
Silverado 1500, 2500, 3500			1999-2004	V8	4.8, 5.3, 6.0L	EP7978M	With Evap Emm. 2 plugs, Code TCF
Silverado 1500, 2500, 3500			1998-2004	V6	4.3L	EP7979M	With Evap Emm. 1 plug, Code TCU
Silverado 1500, 2500, 3500			1998-2004	V8	4.8, 5.3, 6.0L	EP7979M	With Evap Emm. 1 plug, Code TCU
Silverado			1999-2004	V6, V8	ALL	EP7978M	Module Code TCF, 2 plugs
Silverado			1999-2004	V6, V8	ALL	EP7979M	Module Code TCU, 1 plug
CHRYSLER - JEEP USA							
Jeep Cherokee			1986-1990	L6	4.0L	EP6932	
Jeep Cherokee			1991-1993	L4	2.5L	EP6922	
Jeep Cherokee			1994-1996	L4, L6	2.5, 4.0L	EP6998	
Jeep Cherokee			1997-2001	L4, L6	2.5, 4.0L	EP6999	
Grand Cherokee			1997-2004	L6, V8	4.0, 4.7L	EP6999	
Jeep Wrangler			1986-1990	L4	2.5L	EP6922	
Jeep Wrangler			1991-1996	L4, L6	2.5, 4.0L	EP6998	
Jeep Wrangler			1997-2002	L4, L6	2.4, 2.5, 4.0L	EP6999	Pump Only
Jeep Wrangler			1997-2004	L4, L6	2.4, 2.5, 4.0L	EP6983M	OE Module
Neon			1996>	L4 A4	2.0L	EP6969M	
Voyager			1997>	L4 SR4E	3.3L	EP6970M	
CITROEN							
AX			1986>	L4 TU, TUD	1.4L	EP6949	
BX16, BX19			1986-1993	L4 TU, XU, XUD	1.6, 1.9L	EP6949	
C5			2001-2005	L4	2.0L	EP7934	
C5			2001-2005	L6	3.0L	EP7935	
CX25			1985-1992	L4	2.5L	EP6949	
XM			1991-2001	L6	3.0L	EP7936	
XZARA			2000-2005	L4	1.6L	EP7937	
XANTIA			1994-2001	L4	2.0L	EP7936	
DAEWOO							
Cielo DOHC			09/1995>	L4	1.5L	EP6975	
Cielo SOHC			09/1995>	L4	1.5L	EP6975	
Espero DOHC			09/1995>	L4	2.0L	EP6975	
Lanos			1996-2003	L4	1.6L	EP7938	For Complete Module use EP6974M
Lanos			1997-2003	L4	1.5, 1.6L	EP6976M	
Leganza			1997-2001	L4	2.0, 2.2L	EP6974M	
Leganza			1997>	L4	2.0, 2.2L	EP7938	For Complete Module use EP6974M
Nubira 16 Valve			1994-1996	L4	1.5L	EP6974M	
Nubira 16 Valve			2000>	L4	1.6L	EP7940M	
Nubira 16 Valve			2000>	L4	2.0L	EP7941M	
Nubira			1997-2000	L4	2.0L	EP6974M	
Nubira			1998-2000	L4	1.6, 2.0L	EP6974M	
Nubira			2001>	L4	1.6L	EP7940	
Nubira			2001>	L6	2.0L	EP7941	
DAIHATSU							
Applause			1992>	L4 HD SOHC 16V	1.6L	EP6909	
Applause Exi	A101		1989-1992	L4 HD SOHC 16V	1.6L	EP6900	
Charade GTi			1987-1991	L4 HC	1.3L	EP6900	
Charade	G102		1988-1993	L4 HC, HE	1.3, 1.5L	EP6909	
Charade	G202-SEI		1993-1998	L4 HC, HE	1.3, 1.5L	EP6909	
Feroza			10/1988-1992	L4 HD	1.6L	EP6901	
Feroza			1993-1995	L4 HD	1.6L	EP6909	
Mira	L501		1995>	L3 EF Series	660cc	EP6909	
Move			1997-2000	L3	.847L	EP7922	
Pyzar	G303		1996-2000	L4 HE-E	1.5L	EP6909	
Rocky	F80-F87		1987-1991	L4 3Y, 3Y-E	2.0L	EP6901	

VEHICLE APPLICATIONS

Make / Model	Series	Body	Year	Type	CC	Pump	Notes
DAIHATSU cont...							
Rocky FS			07/1990>	L4 HD	1.6L	EP6901	
Sirion			1996-2005	L3	1.0L	EP7922	
Terios	J100, J102		1997>	L4 HC-EJ-K3	1.3L	EP6909	
EUNOS							
30X	KB		1992-1997	V6	1.8L	EP6909	
500	KF		1993-1999	V6	2.0L	EP6909	
800	KJ		1994-2000	V6	2.3L	EP6900	
800	KL		1992-1999	V6	2.5L	EP6900	
FIAT							
Argenter			1981-1986	L4	2.0L	EP6949	
Brava, Bravo			1996>	L4	1.6, 1.8L	EP6973	
Croma iE 120HP			1986-1989	L4	2.0L	EP6949	
Tempra iE	SX		1991-1994	L4	1.8L	EP6973	
Tipo			1988-1994	L4	1.4, 1.6, 1.8L	EP6973	
Uno 70	SX/CTX		1985-1994	L4	1.3, 1.4L	EP6941	
FORD FAIRLANE, LTD - CROSS OVER TO FORD FALCON, FAIRMONT, GHIA							
FAIRLANE	LTD			FALCON EQUIVALENT			
NA	DA			EA			
NC	DC			EB-ED			
NF	DF			EF			
NL	DL			EL			
FORD							
Bronco			1990-1997	V8	5.0L, 5.8L	EP6981M	Plastic Tank
Capri			1980-1981	V6	2.8L	EP6947	
Capri			1982-1987	V6	2.8L	EP6948	
Capri	1, 2SA, SC, SE		1989 - on	L4, B6T	1.6L	EP6909	
Courier 2WD and 4WD			1991-1996	L4 AM OHC EFI	2.6L	EP6900	
Courier	OHC		1991-1996	L4, G6E	2.6L	EP6900	
Escape	ED22		2001 on	L4, ZA	2.0L	EP6990M	
Escape	ED30		2001 on	V6, ZA	3.0L	EP6990M	
Expedition 4WD			1997>	V8	4.6L	EP6955	Oblong Plug, 6.3mm Terminals
Explorer XLT 4WD			1995-1997	V6	4.0L	EP6954	Square Plug, 1.75mm Terminals
Explorer			1995 - 01	V6, V8	4.0, 5.0L	EP6954	Thin Terminals
Explorer			1995 - 01	V6, V8	4.0, 5.0L	EP6955	Thick Terminals
F100 Pick Up			1989 - 97	L6, V8	4.9, 5.0, 7.5L	EP6981M	
F150			1990-1997	V8	5.0L, 5.8L	EP6981M	Plastic Tank
F150, F250, F350			1985-1990	V8	5.0L	EP6935	External H/P Pump
F150, F250, F350			1985-1990	V8	5.0L	EP5907	Intank L/P Pump
F150, F250, F350			1990-1994	V8	5.0L, 5.8L	EP5908	Mid Tank L/P Pump
Falcon Sedan	AU, AU2, AU3	Sedan	1998 - 02	L6, V8	4.0, 5.0L	EP6961	
Falcon Utility	AU, AU2, AU3	Utility	1998 - 02	L6, V8	4.0, 5.0L	EP7908M	
Falcon Wagon	AU, AU2, AU3	Wagon	1998 - 02	L6, V8	4.0, 5.0L	EP6934	Pump Only
Falcon Wagon	AU, AU2, AU3	Wagon	1998 - 02	L6, V8	4.0, 5.0L	EP7901M	Complete Module Assy.
Falcon Sedan Turbo	BA - BA2, BF - BF2	Sedan	2002 - 08	L6	4.0L	EP7905M	
Falcon Sedan XR8	BA - BA2, BF - BF2	Sedan	2002 - 08	V8 DOHC	5.4L	EP7905M	
Falcon Utility	BA - BA2, BF - BF2	Utility	2002 - 08	L6	4.0L	EP7904M	
Falcon Utility	BA - BA2, BF - BF2	Utility	2002 - 08	V8 DOHC	5.4L	EP7906M	
Falcon Utility Turbo	BA - BA2, BF - BF2	Utility	2002 - 08	L6	4.0L	EP7906M	
Falcon Wagon	BA - BA2, BF - BF3	Wagon	2002 - on	L6	4.0L	EP7903M	
Falcon Sedan	BA, BA2, BF	Sedan	2002 - 08	L6, V8 SOHC	4.0, 5.4L	EP7902M	Excluding XR8
Falcon Sedan	EA	Sedan	1987 - 91	L6	3.9L	EP6928	CFI only
Falcon Sedan	EA, EB, ED	Sedan	1988 - 93	L6	3.9, 4.0L	EP6927	Multipoint
Falcon Wagon	EB	Wagon	1993 - 94	L6, V8	4.0, 5.0L	EP7991	
Falcon Wagon	ED	Wagon	1994 - 95	L6, V8	4.0, 5.0L	EP6930	
Falcon Sedan	EF, EL	Sedan	upto - 2/98	L6, V8	4.0, 5.0L	EP6927	
Falcon Wagon	EF, EL	Wagon	1995 - 98	L6, V8	4.0, 5.0L	EP6930	
Falcon Sedan	EL	Sedan	3/98 - on	L6, V8	4.0, 5.0L	EP6961	
Falcon Sedan	XE, XF	Sedan	1983 - 88	L6	4.1L	EP6929	
Falcon Wagon	XE, XF	Wagon	1983 - 88	L6	4.1L	EP6925	H.P. External Pump
Falcon Wagon	XE, XF	Wagon	1983 - 88	L6	4.1L	EP5906	L.P. Intank Lift Pump
Falcon Utility	XG-XH	Utility	1993 - on	L6, V8	4.0, 5.0L	EP6927	
Festiva	DA2		1994 - 98	L4, B3	1.3L	EP6909	
Festiva	DB2		1999 - 02	L4, B3, B5	1.3, 1.5L	EP6989	
Festiva	DB2		1999-2001	L4 B3, B5	1.3, 1.5L	EP6909	

VEHICLE APPLICATIONS

Make / Model	Series	Body	Year	Type	CC	Pump	Notes
FORD cont...							
Focus			2000 on	L4	1.8, 2.0L	EP7943	
Laser	BF		1987 - 90	L4, B3	1.3L	EP6900	
Laser BFTPF			1987-89	L4 B3	1.3L	EP6900	
Laser BHASP			1993-1996	L4, B5, ZE	1.5L	EP6909	
Laser	BH to BJ		1993 - 00	L4, B6	1.6L	EP6909	
Laser BJ			2000 on	L4, Z6	1.6L	EP6909	
Laser BJ6			2000>	L4 Z6	1.6L	EP6909	
Laser BJ6PF			1999-2000	L4 B6	1.6L	EP6909	
Laser KC and Turbo	KC		1983-1984	L4 E5, E5T	1.5L	EP6901	
Laser	KC to KE		1985 - 90	L4, B6, B6T	1.6L	EP6900	
Laser	KF, KH, TX3		1990 - 94	L4, B5, B6	1.5, 1.6L	EP6909	
Laser	KF, KH, TX3		1990-1994	L4 BP DOHC 16V	1.8L	EP6909	
Laser	KF, KH, TX3		1990-1994	L4 B5, B6	1.6L	EP6909	
Laser Liata, Lynx	KJ		1994 on	L4, B6, B6T	1.6L	EP6909	
Laser XR3i	BP		1994>	L4	1.8L	EP6909	
Laser BJ6	BJ		2000>	L4 Z6	1.6L	EP6909	
Mondeo	HA to HE	Sedan, Wagon	1994 - 04	L4, V6	2.0, 2.5L	EP7943	
Mustang			1985 - 97	L4, V6	2.3, 3.8L	EP6996	
Mustang			1985 - 97	V8	4.6, 5.0, 5.8L	EP6996	
Probe	KL DOHC		1994 - 97	V6	2.5L	EP6938	
Sierra			1990-1992	L4	2.0L	EP6923	
Sierra XR4i			1984-1989	V6	2.8L	EP6948	
Taurus	DN to DP		1996 - 99	V6	3.0L	EP6937M	
Telstar			1985-1986	L4 FE	2.0L	EP6901	
Telstar and 12v	12v		1987 - 90	L4, FE	2.0L	EP6900	
Telstar TX5			1990-1996	L4 FS DOHC	2.0L	EP6909	
Telstar TX5	DOHC 24v		1990 - 96	L4, FS	2.0L	EP6909	
Telstar TX5, XRI	DOHC 24v		1992 - 96	V6, KL	2.5L	EP6938	
Territory	Non Turbo		2004 - 09/2007	L6	4.0L	EP7921M	
Territory	Non Turbo		09/2007 on	L6	4.0L	EP7993M	
Territory	Turbo		2004 - 09/2007	L6	4.0L	EP7944M	
Territory	Turbo		09/2007 on	L6	4.0L	EP7992M	
Transit	VF, VG, VH, VJ		1997-2005	L4	2.0, 2.3L	EP7946	
HOLDEN							
Adventra X8	VY CX8, LX8		08/2003-08/2004	V8 Gen III LS1	5.7L	EP7910M	To 156716
Adventra X8	VY CX8, LX8		08/2003-08/2004	V8 Gen III LS1	5.7L	EP7915M	Fm 156717
Adventra	VY-VZ	Wagon	2004>	V6 Alloy Tech	3.6L	EP7917M	4 Pin Oval
Adventra	VY-VZ	Wagon	2004>	V8 GEN 3 LS1	5.7L	EP7915M	4 Pin Oval
Astra	AH		2005>	L4 Z18XE	1.8L	EP6913	38mm Body
Astra	AS14		1995-2000	L4 C14NZ	1.4L	EP7947	43mm Body
Astra	AS18		1995-2000	L4 C18NZ	1.8L	EP7947	43mm Body
Astra TBI			1996	L4	1.4L	EP7973	
Astra	TR		1995-2000	L4 C16	1.6L	EP7947	43mm Body
Astra	TS		1998-2000	L4 X18	1.8L	EP7947	43mm Body
Astra	TS		2001>	L4 X22SE	2.2L	EP6913	38mm Body
Barina	XC		05/2001-02/2006	L4 Z14, Z18, XE, P	1.4, 1.8L	EP7947	
Barina	XC		2001>	L4 X14XE	1.4L	EP6913	
Barina	Gti		1986-1988	L4 G13A, G13B	1.3L	EP6900	
Barina	SB		1990-1994	L4	1.2, 1.4, 1.6L	EP6909	
Barina Joy			1994-1997	L4 C14NZ	1.4L	EP6913	
Barina Merit			1995-2000	L4 C12NZ	1.2L	EP6913	
Camira JJ Isuzu Engine			1984-1989	L4 4ZB1J, 4ZC1J	1.8, 2.0L	EP6925	
Commodore	VK		1985-1986	L6	3.3L	EP6925	
Commodore	VL		1986-1988	L6 RB20, RB30	2.0, 3.0L	EP6925	
Commodore	VL		1986-1988	L6 RB20, RB30	2.0, 3.0L	EP5920	Intank L/P Pump
Commodore	VE	ALL	2007>	V6 Alloytech	3.6L	EP7976	
Commodore	VE	ALL	2007>	V8 GEN 4 LS2	6.0L	EP7976	
Commodore	VN	ALL	1988-91	V6 & V8	3.8L, 5.0L	EP6925	85L Tank, External HP Pump
Commodore	VN	ALL	1988-91	V6 & V8	3.8L, 5.0L	EP5920	85L Tank, Intank LP Pump
Commodore	VN	ALL	1988-91	V6 & V8	3.8L, 5.0L	EP6923	65L Tank, Single Intank Pump
Commodore	VP, VR, VS	ALL	1991-96	V6 & V8	3.8L, 5.0L	EP6923	65L Tank, Single Intank Pump
Commodore	VT, VX	ALL	1997-01	V6 & V8	3.8, 5.0, 5.7L	EP6934	Pump Only, Vin # up to L763312
Commodore	VT, VX	ALL	1997-01	V6 & V8	3.8, 5.0, 5.7L	EP7900M	Module, 4 Pin Square, Vin # up to L763312
Commodore V6 Supercharged	VT, VX, VX II	Sedan, Wagon	1997-7/02	V6	3.8L	EP6986M	4 Pin Square, Vin # up to 3L893056
Commodore	VT II, VX	ALL	2000-01	V8 GEN 3 LS1	5.7L	EP6960M	4 Pin Square, Vin # up to L763312
Commodore	VU	Ute	2000-7/02	V6	3.8L	EP7919M	4 Pin Square
Commodore	VU	Ute	2000-7/02	V8 GEN 3 LS1	5.7L	EP7909M	4 Pin Square

VEHICLE APPLICATIONS

Make / Model	Series	Body	Year	Type	CC	Pump	Notes
HOLDEN cont...							
Commodore	VX II	Sedan, Wagon	7/01-7/02	V6	3.8L	EP7918M	4 Pin Square, Vin # L763313 to 3L892098
Commodore	VX II	Sedan, Wagon	2001-02	V8 GEN 3 LS1	5.7L	EP7928M	4 Pin Square, Vin # L763313 to 3L891247
Commodore	VX II, VY	Sedan, Wagon	7/02-7/03	V6	3.8L	EP7920M	4 Pin Oval, Vin # 3L892099 to 4L156716
Commodore	VX II, VY	Sedan, Wagon	7/02-7/03	V8 GEN 3 LS1	5.7L	EP7910M	4 Pin Oval, Vin # 3L891428 to 4L156716
Commodore V6 Supercharged	VX II, VY, VY II	Sedan, Wagon	7/02-2004	V6	3.8L	EP7907M	4 Pin Oval, Vin # 3L893057 onwards
Commodore	VY	Ute	7/02-7/03	V6	3.8L	EP7911M	4 Pin Oval, Vin # up to 4L156716
Commodore	VY	1 Tonne Flat Deck	7/02-7/03	V6	3.8L	EP7972	Note 1
Commodore	VY	Ute	7/02-7/03	V8 GEN 3 LS1	5.7L	EP7912M	4 Pin Oval, Vin # up to 4L156716
Commodore	VY	1 Tonne Flat Deck	7/02-7/03	V8 GEN 3 LS1	5.7L	EP7972	Note 1
Commodore	VY II	Sedan, Wagon	7/03-2004	V6	3.8L	EP7913M	4 Pin Oval, Vin # from 4L156717
Commodore	VY II	Ute	7/03-2004	V6	3.8L	EP7914M	4 Pin Oval, Vin # from 4L156717
Commodore	VY II	1 Tonne Flat Deck	7/03-2004	V6	3.8L	EP7972	Note 1
Commodore	VY II	Sedan, Wagon	7/03-2004	V8	5.7L	EP7915M	
Commodore	VY II	Sedan, Wagon	7/03-2004	V8 GEN 3 LS1	5.7L	EP7915M	4 Pin Oval, Vin # from 4L156717
Commodore	VY II	Ute	7/03-2004	V8 GEN 3 LS1	5.7L	EP7916M	4 Pin Oval, Vin # from 4L156717
Commodore	VY II	1 Tonne Flat Deck	7/03-2004	V8 GEN 3 LS1	5.7L	EP7972	Note 1
Commodore	VZ	Sedan, Wagon	2004-06	V6 Alloy Tech	3.6L	EP7917M	
Commodore	VZ	Ute	2004>	V6 Alloy Tech	3.6L	EP7923M	
Commodore	VZ	1 Tonne Flat Deck	2004>	V6	3.6L	EP7972	Note 1
Commodore	VZ	Sedan, Wagon	2004-06	V8 GEN 3 LS1	5.7L	EP7915M	
Commodore	VZ	Ute	2004>	V8 GEN 3 LS1	5.7L	EP7924M	
Commodore	VZ	1 Tonne Flat Deck	2004>	V8 GEN 3 LS1	5.7L	EP7972	Note 1
Commodore	VZ	Sedan, Wagon	2006>	V8 GEN 4 LS2	6.0L	EP7925M	
Commodore	VZ	Ute	2006	V8 GEN 4 LS2	6.0L	EP7974M	
Commodore	VZ	1 Tonne Flat Deck	2006	V8 GEN 4 LS2	6.0L	EP7972	Note 1
Crewman	VZ	Ute	2006>	V6 Alloy Tech	3.6L	EP7972	Note 1
Crewman	VZ	Ute	2006>	V8 GEN 4 LS2	6.0L	EP7972	Note 1
Cross 6	VZ	Wagon	2006>	V6 Alloy Tech	3.6L	EP7972	Note 1
Cross 8	VZ	Wagon	2006>	V8 GEN 4 LS2	6.0L	EP7972	Note 1
Note 1 = Vehicles are fitted with a Denso module including saddle tank variants. EP7972 is a pump only with fitting kit.							
Cruz	YG		2002>	L4 M15A	1.5L	EP6913	
Epica	CDX, CDXI		2007>	L4	2.5L	EP7969M	
Jackaroo	UBS17		1988-1993	L4 4JB1, 4ZE1	2.3, 2.6L	EP6914	
Jackaroo	UBS25, UBS69		1993>	V6 6VD1	3.2L	EP6909	
Jackaroo	UBS92		09/1993-02/1998	V6 6VD1, 6VE1	3.2L	EP6909	
Jackaroo	UBS97		03/1998-2003	V6 6VE1	3.2L	EP6909	
Rodeo	4ZE1		1994>	L4 4ZE1	2.6L	EP6909	
Rodeo	R9		1998-2003	V6 6VD1	3.2L	EP7922	
Rodeo	RA		2003>	L4 C24SE	2.4L	EP7968	
Rodeo	RA		2003>	V6 6VE1	3.5L	EP7968	
Rodeo V6			1994>	V6 6VD1	3.2L	EP6909	
Rodeo	TFR17, TFS17		1991-1994	L4 4ZE1	2.6L	EP6914	
Rodeo 2WD	TFR25		1992-1999	V6 6VD1	3.2L	EP6909	
Rodeo	TFR77		2002>	L4 4JHI-T	3.0L	EP6909	
Suburban	FK1		2002>	V8 RCWG	5.0L	EP7980M	
Vectra	JR		1993-1998	L4 X20XE, V6 X25	2.0L, 2.5L	EP7947	43mm Body
Vectra	JS		1996-2000	V6 X25XE	2.5L	EP6913	38mm Body
Vectra	JS, JSII		2000-2002	V6 X2EXE	2.6L	EP6913	38mm Body
Vectra	VE20		1996-9900	L4 X20XE	2.0L	EP6913	38mm Body
Vectra	VE22		2000-2002	V6 X22XE	2.2L	EP6913	38mm Body
Vectra	ZC		2003>	L4, V6 Z22, Z23SE	2.2, 3.2L	EP6913	38mm Body
Zafira			2001>	L4 Z22SE	2.2L	EP6909	
HOLDEN STATESMAN							
STATESMAN WH	REFER COMMODORE VT / VX						
STATESMAN WK	REFER COMMODORE VY						
STATESMAN WL	REFER COMMODORE VZ						
STATESMAN WM	REFER COMMODORE VE						
HONDA							
Accord	CA		1985-07/1989	L4 A18, A20	1.8, 2.0L	EP6902	
Accord	CA2		1985-1989	L4 B18A	1.8L	EP6902	
Accord	CB		08/1989-08/1993	L4 F18, F20	1.8, 2.0L	EP6905	
Accord	CB		08/1989-08/1993	L4 F22	2.2L	EP6905	
Accord	CD		08/1993-1997	L4 F18, F20	1.8, 2.0L	EP6905	
Accord	CD		08/1993-1997	L4 F22, H22	2.2L	EP6905	
Accord	CD6		1993-1997	L4 H22A	2.2L	EP6905	
Accord S/W	CE1		1993-1997	L4 F22B	2.2L	EP6905	

VEHICLE APPLICATIONS

Make / Model	Series	Body	Year	Type	CC	Pump	Notes
HONDA cont...							
Accord S/W	CF4		1997>	L4 F20B	2.0L	EP6905	
Accord	CF8		1998>	L4 F23A	2.3L	EP6905	
Accord	CG1		1997>	V6 J30A	3.0L	EP6905	
Accord	CL9		2003>	L4 K24A	2.4L	EP6909	
Accord	UA		07/1995>	V6 G32A	3.2L	EP6905	
Ascot	CB1		1989-1995	L4 F18A	1.8L	EP6905	
Ascot 4WS	CB4		1990-1995	L4 F20A	2.0L	EP6905	
Ascot	CC4		1992-1995	L4 H23A	2.3L	EP6909	
Ascot	CC5		1992-1995	L4 F23A	2.3L	EP6904	
Ascot	CE4		1992-1995	L5 G20A	2.0L	EP6904	
Ascot	CE5		1993-1995	L5 G25A	2.5L	EP6904	
Ballade	AK		09/1983-09/1987	L4 EW	1.5L	EP6901	
City	GA1		1987-1989	L4 D12A	1.2L	EP6902	
City	GA2		1989-1994	L4 D13C	1.3L	EP6902	
Civic	AH, AK		09/1983-1986	L4 EW	1.5L	EP6901	
Civic	ED3		1988-1992	L4 D15B	1.5L	EP6902	
Civic	ED6		1990-1993	L4 D15B	1.5L	EP6904	
Civic	EF2, EF3, EF4		1987-08/1991	L4 D13, D15, ZC	1.3, 1.5, 1.6L	EP6902	
Civic	EF5		1989-1991	L4 ZC	1.6L	EP6904	
Civic	EG3		1991-1995	L4 D13B	1.3L	EP6909	
Civic	EG6		1991-1995	L4 B16A	1.6L	EP6904	
Civic	EG7		1991-1995	L4 D13B	1.3L	EP6904	
Civic	EG8		1992	L4 DB15B	1.5L	EP6904	
Civic	EJ, EK		09/1991>	L4 D15, D16, ZC	1.5, 1.6L	EP6904	
Civic	EJ1		1993-1997	L4 D16A	1.6L	EP6904	
Civic	EJ3		1993-1995	L4 ZC	1.6L	EP6904	
Civic	EK2		1995-1997	L4 D13B	1.3L	EP6904	
Civic	EK3		1995-1999	L4 D15B	1.5L	EP6904	
Civic	ES8		2001>	L4 D15Y	1.5L	EP6904	
Civic	EU1		2001>	L4 D15Y	1.5L	EP6904	
Civic	EU2		2000-2001	L4 D16Y	1.6L	EP6904	
Civic	EU3		2001>	L4 D17A	1.7L	EP6904	
Concerto	MA1		1988-1992	L4 D15B	1.5L	EP6902	
Concerto	MA2, MA3		06/1988>	L4 D16, ZC	1.6L	EP6904	
CRV	E-RDI		10/1995-2001	L4 B20B	2.0L	EP6905	
CRV	RD7		2002>	L4 K24A	2.4L	EP6909	
CRV			2001>	L4 K24	2.4L	EP6904	
CRX	EF		1987-08/1991	L4 D15, D16, ZC	1.5, 1.6L	EP6902	
CRX	EF6		1987-1991	L4 D15B	1.5L	EP6902	
Domani	MA4, MA5		1992-1996	L4 ZC	1.6L	EP6904	
Domani	MA7		1994-1998	L4 D15B	1.5L	EP6904	
Domani	MB4		1997-1999	L4 D16A	1.6L	EP6904	
Inspire	CC2		1992-1996	L5 G25A	2.5L	EP6904	
Inspire	UA2		1995-1997	L5 G25A	2.5L	EP6905	
Integra	DA, DB		11/1985-07/1993	L4 ZC, B18A,B18B	1.6, 1.8L	EP6902	
Integra	DC		08/1993-09/2001	L4 B18B	1.8L	EP6904	
Jazz	GD1		2002>	L4 L13A	1.3L	EP6904	
Legend	KA1, KA5		12/1985-09/1991	L4 C20A	2.0L	EP6902	
Legend	KA2		12/1985-09/1991	V6 C25A, C27A	2.5, 2.7L	EP6902	
Legend	KA7, KA8, KA9		10/1991>	V6 C32A, C35A	3.2, 3.5L	EP6902	
Logo			1996-1999	L4 GA3	1.3L	EP6904	
NSX	NA1		08/1990>	V6 C30A	3.0L	EP6919	OE High Performance Pump
Odyssey	RA1, RA2		09/1994>	L4 F22B	2.2L	EP6905	
Odyssey 4WD	RA9		2000-2005	V6 J30A	3.0L	EP6905	
Prelude	AB		1983-04/1985	L4 A20A	2.0L	EP6901	
Prelude	BA		05/1985-10/1991	L4 B20A	2.0L	EP6902	
Prelude	BA8, 9		1991-1994	L4 F20A	2.0L	EP6902	
Prelude	BB		11/1991-1995	L4 B20B, F22A	2.0, 2.2L	EP6902	
Prelude	BB2		1991-1996	L4 H23A	2.2L	EP6902	
Prelude	BB6		1996>	L4 H22A	2.2L	EP6904	
Shuttle	AK		09/1983-09/1987	L4 EW	1.5L	EP6901	
Shuttle	EF, EF2		10/1987-1995	L4 ZC	1.6L	EP6902	
Shuttle	EY4		1987-1995	L4 D15B	1.5L	EP6902	
Vigor	AD		06/1983-06/1985	L4 ES	1.8L	EP6901	
Vigor	CA, CB		06/1985-10/1991	L4 B20A, F20A	2.0L	EP6902	
Vigor	CB5		1989-1991	L5 G20A, G25A	2.0, 2.5L	EP6902	
Vigor	CC2		1992-1995	L5 G25A	2.5L	EP6902	

VEHICLE APPLICATIONS

Make / Model	Series	Body	Year	Type	CC	Pump	Notes
HYUNDAI							
Accent	GA21		1994-1997	L4 GUEH	1.5L	EP6909	
Accent			1995-1999	L4 G4EK / G4FK	1.5L	EP6962	
Accent			2000-2005	L4 G4EC	1.5L	EP7994	
Accent			2000-2005	L4 G4ED	1.5L	EP7994	
Elantra			2001-2006	L4	1.6L	EP7998	
Elantra			2001-2006	L4 G4GB	1.8L	EP7998	
Elantra			2001-2006	L4 G4GC	2.0L	EP7998	
Excel	X2		1990-1993	L4 4G15	1.5L	EP6951	
Excel	X2		1991-1994	L4 4G15	1.5L	EP6951	
Excel	X3		1994-1999	L4 G4EK	1.5L	EP6963	
Excel	X3		1995>	L4 G4E	1.5L	EP6909	
Getz			2002-2005	L4 G4EA	1.3L	EP7996	
Getz			2002-2005	L4 G4EC	1.5L	EP7996	
Getz			2005-on	L4 G4EE	1.4L	EP7996	
Getz			2005-on	L4 G4ED	1.6L	EP7996	
Grandeur			2001-2005	V6 G6CT	3.0L	EP6962	
Grandeur			2001-2005	V6 G6CU	3.5L	EP6962	
Lantra	J1		1990-1995	L4 G4CR, L4 G4CN	1.6L	EP6909	
Lantra	J2		1995-2000	L4 G4GM	1.8L	EP6962	
Lantra	J2		1995-2000	L4 G4GF	2.0L	EP6962	
Lantra	JRFG		1991>	L4 G40R DOHC	1.6L	EP6909	
Lantra	KF2, KF3		01/1991>	L4 4G67 DOHC	1.8L	EP6909	
Lantra			1995-2002	L4	1.6, 1.8L	EP6909	
Santa Fe	CM		2007-on	L4 G4CS	2.4L	TBA	
Santa Fe	CM		2007-on	V6 G6EA	2.7L	TBA	
Santa Fe	SM		2001-2006	L4 G4JS	2.4L	EP7994	
Santa Fe	SM		2001-2006	V6 G6BA	2.7L	EP7994	
Santa Fe			2000>	V6	2.7L	EP6909	
S-Coupe			1990-1994	L4 LG15	1.5L	EP6951	
Sonata	DF31 Y2, Y3		1993-1998	L4 G4CP	2.0L	EP6909	
Sonata	EF		1998-2001	L4	2.0L	EP6909	
Sonata	G406		12/1991-05/1996	L4 4G63, G4P	2.0L	EP6952	
Sonata	GLS, G276m G676 Y1		04/1989-1992	L4 4G64 SOHC	2.4L	EP6952	
Sonata	Y1		04/1989-1992	V6 G672	3.0L	EP6952	
Sonata	Y2		1989-1992	L4 G4CP	2.0L	EP6952	
Sonata	Y2		1989-1992	L4 G4CS	2.4L	EP6952	
Sonata	Y2		1989-1992	V6 G6AT	3.0L	EP6952	
Sonata	Y2		1993-1996	V6 G6AT	3.0L	EP6909	
Sonata	Y3		1992-1998	L4 G4CP	2.0L	EP6909	
Sonata	Y3		1992-1998	L4 G4CS	2.4L	EP6909	
Sonata	Y3		1992-1998	L4 G6AT	3.0L	EP6909	
Sonata	Y3		1993-1996	V6 G6AT	3.0L	EP6909	
Sonata			1999-2001	L4 G4CS	2.4L	EP6962	
Sonata			1999-2001	V6 G6BV	2.5L	EP6962	
Sonata			2002-2005	V6 EFB	2.7L	EP6909	
Sonata			2002-2005	L4 G4JS	2.4L	EP7996	
Sonata			2002-2005	V6 G6BA	2.7L	EP7996	
Sonata			2006>	V6 NF	3.3L	EP6909	
Sonata			2006-2008	L4 G4JS	2.4L	EP7998	
Sonata			2006-2008	V6 G6DB	3.3L	EP7998	
Terracan			2001-2007	V6 G6CU	3.5L	EP6909	
Tiburon			2002-2008	L4 G4GC	2.0L	EP7998	
Tiburon			2002-2008	V6 G6BA	2.7L	EP7998	
Trajet			2000>	V6 G6BA	2.7L	EP7998	
Trajet			2001>	V6 G6B	2.6L	EP6909	
Tucson			2004>	V6 G6B	2.6L	EP6909	
Tucson			2004>	L4 G4JP	2.0L	EP7998	
Tucson			2004>	V6 G6BA	2.7L	EP7998	
ISUZU							
Bighorn/Trooper			1988-1994	L4 4ZE1	2.6L	EP6914	
Bighorn/Trooper			1992-1996	V6 6VD1	3.2L	EP6914	
Bighorn/Trooper			1996>	V6 6VD1, 6VE1	3.2, 3.5L	EP6909	
MU Non Turbo			1989	L4	2.6L	EP6914	
MU Turbo			1990-1997	L4 4JB1-T	2.8L	EP6914	
Piazza			05/1983-1988	L4 G200Z	2.0L	EP6910	
Pickup 4WD (VAN)	TFR, TFS		1988-1994	L4 4ZE1 OHC	2.6L	EP6914	
Trooper 4WD	UBS17		09/1988-1994	L4 4ZE1 OHC	2.6L	EP6914	

VEHICLE APPLICATIONS

Make / Model	Series	Body	Year	Type	CC	Pump	Notes
JAGUAR / DAIMLER							
Sovereign			1990-1994	L6	4.0L	EP6953	
XJ6			1978-1987	L6	4.2L	EP6918	
XJ6			1988-1992	L6	3.6, 4.0L	EP6916	
XJ6			1992-1996	L6	3.2, 4.0L	EP6953	
XJ12, XJS			1978-1991	V12	5.3L	EP6918	
XJ12			1992>	V12	6.0L	EP6953	
XJR			1995-2000	L6, V8	4.0L	EP7942	
XJS			1975-1982	V12	5.3L	EP7950	
KIA							
Camival			1999>	V6 K5	2.5L	EP7951	
Credos			1998-2001	L4	2.0L	EP7964	
Mentor Series			07/1996>	L4	1.5L	EP6962	
Sorento			2003>	V6 G6C	3.5L	EP6909	
Sportage			07/1996>	L4	2.0L	EP6963	
LEXUS							
ES300			1990>	V6 3VZ-FE	3.0L	EP6931	
ES300	MCV20		1994>	V6 1MZ-FE	3.0L	EP6931	
ES300	VCV10		1992-1998	V6 3VZ-FE	3.0L	EP6931	
IS200			1999-2000	L6 1G-FE	2.0L	EP6931	
LS400			1990-2000	V8 1UZ-FE	4.0L	EP6965	
LX470			1998>	V8 2UZ-FE	4.7L	EP6931	
SC400			1995>	V8 1UZ-FE	4.0L	EP6965	
MARINE							
Mercuriser			1991>	V6	4.3L	EP6978	High Pressure Pump
MPI Heavy Duty - Jet Boats				ALL	ALL	EP6984HD	Heavy Duty Drive
O.M.C. - Low Pressure			1992-1994	V6	4.3L	Refer CDL	
Volvo - Penta - Low Pressure			1993-1994	V8	7.4L	Refer CDL	
Volvo - Penta 2 Pumps Used - Low Press.			1994-1996	V8	5.0, 5.8L	Refer CDL	
Volvo - Penta 2 Pumps Used			1994>	V8	5.0, 5.8L	EP6978	High Pressure Pump
Volvo - Penta - Low Pressure			1992-1996	V6	4.3L	Refer CDL	
Volvo - Penta - Low Pressure			1994>	V6	4.3L	Refer CDL	
MARINE UNIVERSAL PUMPS							
MPI Inline Pump				All		EP6907	280L/Hour, 120 PSI
TBI Inline Pump				All		EP6921	200 L/Hour, 16 PSI
MAZDA							
121			10/1990>	L4 B3, B5	1.3, 1.5L	EP6909	
3			2004>	L4	2.0L	EP6909	
3			2004>	L4	2.3L	EP6909	
6	GG3S		2002>	L4	2.3L	EP6909	
323	BA		09/1994-1998	L4 B6, BP	1.6, 1.8L	EP6909	
323 Familia 16v	BA		1994-1998	L4 Z5	1.5L	EP6909	
323	BD incl Turbo		01/1983-01/1985	L4 E5, E5T	1.5L	EP6901	
323	BF incl Turbo		01/1985-08/1989	L4 B6, B6T	1.6L	EP6900	
323	BG		08/1989-09/1994	L4 B5, B6, BP	1.5, 1.6, 1.8L	EP6909	
323	BJ5P		1998-2000	L4 ZL-VE	1.5L	EP6909	
323 (Wagon)	BJ5W		1998-2001	L4 ZL-VE	1.5L	EP6909	
626	GC		04/1983-02/1985	L4 FE	2.0L	EP6901	
626	GD		03/1985-10/1991	L4 F8, FE F2	1.8, 2.0, 2.2L	EP6900	
626	GE		12/1991-06/1997	LF FS	2.0L	EP6909	
626	GE		12/1991-06/1997	V6 KL	2.5L	EP6938	
626	GF		07/1997-06/2002	L4 FE	2.0L	EP6989	
626 (Wagon)	GV		1993-1997	L4 FE, F2	2.0L	EP6909	
626 (Wagon)	GW		1998-2003	L4 FS	2.0L	EP6989	
929/Luce			09/1983-02/1985	L4 FE	2.0L	EP6901	
929/Luce			07/1986-1991	V6 JF	2.0L	EP6900	
929/Luce			10/1987-1991	V6 JE, JET	3.0L	EP6900	
Astina	BA		1994-1998	B6, BP	1.6, 1.8L	EP6909	
Astina	BG		1989-1994	B5, B6, BP	1.5, 1.6, 1.8L	EP6909	
Autozam	AZ3		1991-9500	L4 B5	1.5L	EP6909	
B2200	UE96		1990-1992	L4 FS	2.2L	EP6900	
B2600 2WD, 4WD			1992-04/1996	L4 G6	2.6L	EP6900	
Bounty			05/1996>	L4	2.6L	EP6909	
Capella	GD		1985-1991	L4 F8, FE	1.8, 2.0L	EP6909	

VEHICLE APPLICATIONS

Make / Model	Series	Body	Year	Type	CC	Pump	Notes
MAZDA cont...							
Capella	GE		1991-1997	L4 FS, F2	2.0, 2.2L	EP6900	
Capella	GF		1997-2003	L4 FS	2.0L	EP6989	
Capella (Wagon)	GV		1992-1997	L4 FE, F2	2.0, 2.2L	EP6909	
Capella (Wagon)	GW		1997-2003	L4 FS	2.0L	EP6989	
Demio DC	DC		1996>	L4 B3, B5	1.3, 1.5L	EP6989	
Etude			02/1988>	L4 B5	1.5L	EP6900	
Lantis			1993-1997	V6 KF	2.0L	EP6938	
MPV			01/1990>	V6 JE, JEE	3.0L	EP6909	
MPV			12/1994-1998	V6, G5, G5E	2.5L	EP6909	
MPV	LW5W		1999>	V6 GY	2.5L	EP6909	
MS6 - Cronos			1991-1995	V6 K8, KF	1.8, 2.0L	EP6938	
MS8			1992-1995	V6 KF, KL	2.0L	EP6938	
MX5 - Miata			1989-1994	L4 B6	1.6L	EP6909	
MX5	NB8C		1998>	L4 BP	1.8L	EP6989	
MX6	GM35		1990-1994	L4 FE	2.0L	EP6909	
MX6			1990-1996	V6 KF, KL	2.0, 2.5L	EP6938	
RX7			1986-1994	13B	1.3L	EP6900	
RX7 Turbo			1989-1995	13BT	1.3L	EP6933	OE High Performance Pump
Sentia	HD5S		1991-1995	V6 J5-DE	2.5L	EP6909	
Sentia	HDFS, HDES		1991-1995	V6 JE-ZE	3.0L	EP6909	
Tribute	ED22		2001>	L4	2.0L	EP6990M	
Tribute	ED25		2001>	V6	2.5L	EP6990M	
Tribute	ED30		2001>	V6	3.0L	EP6990M	
MERCEDES BENZ							
190, 190E			1986-1994	W301	2.0L	EP6948	
230 Series			1981>	W123	2.3L	EP6948	
250 Series			1977-1985	L6 DOHC	2.8L	EP6948	
280 Series			1977>	L6	2.8L	EP6948	
300 Series			1986>	L6	3.0L	EP6948	
380 Series			1981-1986	V8 OHC	3.8L	EP6948	
420 Series			1979-1988	W126	4.2L	EP6948	
450 Series			1973-1980	V8 OHC	4.5L	EP6947	
500 Series			1980-1992	W126	5.0L	EP6948	
500 Series			1980-1992	V8	5.0L	EP6943	
560 Series			1983-1992	W126	5.5L	EP6942	
500			1994>	V8	5.0L	EP6994	
600			1981-1993	V8	6.0L	EP6942	
C230			1994>	L4	2.3L	EP6994	
C43			1994>	V8	4.3L	EP6994	
CL500			1994>	V8	5.0L	EP6994	
CL55			1994>	V8	5.5L	EP6994	
CLK430			1994>	V8	4.3L	EP6994	
CLK55			1994>	V8	5.5L	EP6994	
E320			1994>	V6	3.2L	EP6994	
E55			1994>	V8	5.5L	EP6994	
G55			1994>	V8	5.5L	EP6994	
S320			1994>	V6	3.2L	EP6994	
S430			1994>	V8	4.3L	EP6994	
S500			1994>	V8	5.0L	EP6994	
S55			1994>	V8	5.5L	EP6994	
SL320			1994>	V6	3.2L	EP6994	
SL500			1994>	V8	5.0L	EP6994	
SLK230			1994>	L4	2.3L	EP6994	
MITSUBISHI							
Carisma	DA2A		1996-2000	L4 4G93	1.8L	EP6909	
Challenger	K99		1996-1999	V6 6G74	3.5L	EP6909	
Chariot / 4WD			1991-1995	L4 4G93, 4G63	1.8, 2.0L	EP6909	
Chariot	N84W		1997>	L4 4G64	2.4L	EP6909	
Cordia Includes Turbo			1984-1986	L4 G62B, G62BT	1.8L	EP6901	
Debonair			10/1986-1991	V6 6G72	3.0L	EP6908	
Debonair			10/1992>	V6 6G74	3.5L	EP6909	
Delica	PA, PD4W		1994-1996	L4 4G64	2.4L	EP6909	
Diamante			1990-1999	V6 6G72, 6G74	3.0, 3.5L	EP6909	
Diamante	F15A, F25A, F31A		05/1990-1997	V6 6G71, 72, 73	2.0, 2.5, 3.0L	EP6909	
Diamante	TJ		2002>	V6 6G74	3.5L	EP6909	
Eclipse Includes Turbo			02/1990>	L4 4G63, 63T	2.0L	EP6909	

VEHICLE APPLICATIONS

Make / Model	Series	Body	Year	Type	CC	Pump	Notes
MITSUBISHI cont.,,							
Evolution 4 to 9				L4	2.0L	EP7981	
FTO Coupe			10/1994-1996	V6 6A12	2.0L	EP6909	
Galant	E17A		1987-1991	V6 6G71	2.0L	EP6909	
Galant	E35A		1989-1992	L4 4G67	1.8L	EP6909	
Galant	E53A		1992-1996	V6 AII	1.8L	EP6909	
Galant	EA2A		1997>	L4 4G63	2.0L	EP6909	
Galant	EC5A		1996>	V6 6A13	2.5L	EP6909	
Galant Turbo	EC5A		1996>	V6 6A13-T	2.5L	EP6909	
Galant, Sigma, Eterna Incl. Turbo			1984-1985	L4 4G37, 4G37T	1.8L	EP6901	
Galant, Sigma, Eterna Incl. Turbo			1984-1985	L4 4G63, 4G63T	2.0L	EP6901	
Galant, Sigma, Eterna	EA2A		1986-1989	L4 4G37B, 4G63	1.8, 2.0L	EP6908	
Galant, Sigma, Eterna			1990-2001	L4 4G37, 63, 93	1.8, 2.0L	EP6909	
Galant			02/1992-1996	V6 6A12, 6A13	2.0, 2.5L	EP6909	
Galant			2001>	L4 4G63	2.0L	EP6909	
Galant	SJ		1993-1996	L4 4G93	1.8L	EP6909	
GTO Turbo	Z16A		1992>	V6 6G72T	3.0L	EP6965	
GTO Non Turbo	Z16A		1992>	V6 6G72	3.0L	EP6909	
L200			1992-2000	V6 6G72	3.0L	EP6909	
L200	K65		1997>	L4 4G64	2.4L	EP6909	
L300			1989-1994	L4 4G63, 4G64	2.0, 2.4L	EP6908	
L300			1995-2000	L4 4G63, 4G64	2.0, 2.4L	EP6909	
Lancer			04/1986-05/1989	L4 4G15	1.5L	EP6908	
Lancer	CA		06/1989-08/1990	L4 4G15, 4961	1.5, 1.6L	EP6909	
Lancer	CB		09/1990-10/1992	L4 4915, 4961	1.5, 1.6L	EP6909	
Lancer	CC		10/1992-07/1996	L4 4992, 4993	1.6, 1.8L	EP6909	
Lancer	CJ1A, CK1A		1995-1999	L4 4G13	1.3L	EP6909	
Lancer	CS5A		2000>	L4 4G93	1.8L	EP6909	
Lancer Turbo	CT9A		1999>	L4 4G63T	2.0L	EP6909	
Lancer	LJ1, LJ2, LJ5, LJ6		1993-1997	L4 4G93	1.8L	EP6909	
Lancer	LM6S		2000>	L4 4G93	1.8L	EP6909	
Legnum	EA1W, EC1W		1996-2000	L4 4G93	1.8L	EP6909	
Legnum	EA5W, EC5W		1996-1998	V6 6A12, 6A13	2.0, 2.5L	EP6909	
Libero	CB2W		1992-1996	L4 4G15	1.5L	EP6909	
Libero	CB5W, CD5W		1992-1996	L4 4G93	1.8L	EP6909	
Magna	TM, TN, TP		1987-10/1991	L4 4G54	2.6L	EP6908	
Magna	TR, TS		10/1991-1996	L4 4G54	2.6L	EP6909	
Magna	TR, TS		10/1991-1996	V6 6G72	3.0L	EP6909	
Magna	TE, TF, TH		1996>	L4 4G64	2.4L	EP6909	
Magna	TF, TH		1996>	V6 6G73, 6G74	2.5, 3.5L	EP6909	
Mirage, Geneva			10/1987-07/1991	L4 4G15B, 4G61	1.5, 1.6L	EP6908	
Mirage, Geneva Incl. Turbo			08/1991>	L4 4G91, 92, 93	1.5, 1.6, 1.8L	EP6909	
Mirage, Geneva			11/1995>	V6 6A11	1.8L	EP6909	
Mirage FWD	CA1A		1991-1996	L4 4G13	1.3L	EP6909	
Mirage	CJ1A, CK1A		1995-1999	L4 4G13	1.3L	EP6909	
Mirage	MM1L2		1996-1999	L4 4G15	1.5L	EP6909	
Nimbus	PD43		1998>	L4 4G64	2.4L	EP6909	
Pajero			1990-1996	V6 6G72	3.0L	EP6909	
Pajero			1994>	V6 6G74	3.5L	EP6909	
RVR	N23W		1991-1997	L4 4G63	2.0L	EP6909	
RVR FWD	N61W		1997-2000	L4 4G93	1.8L	EP6909	
RVR 4WD	N74W		1997-2000	L4 4G64	2.4L	EP6909	
Starion Turbo			05/1982-03/1988	L4 4G63-T OHC	2.0L	EP6901	
Tredia Turbo			03/1982-07/1985	L4 G32B, G62B	1.6, 1.8L	EP6901	
Triton	K76		2001>	V6 6G72	3.0L	EP6909	
V2000			1986>	6G71	2.0L	EP6908	
V3000	EA, EB, EC		1986-1989	V6 6G72	3.0L	EP6908	
V3000, Verada	KR, KS		1989-1996	V6 6G72	3.0L	EP6909	
NISSAN							
200SX			1994>	L4 SR18, SR20	1.8, 2.0L	EP6958	Acetal Module
280C, ZX			11/1979-10/1984	L6 L28E	2.8L	EP6910	
300ZX			1984-1989	V6 VG30E	3.0L	EP6912	
300ZX			1989-1993	V6 VG30DE	3.0L	EP6912	
350Z			2003-2005	V6 VQ35DE	3.5L	EP7952	
Avenir	EW10, PW10, PW11		05/1990>	L4 SR18, SR20 DE	1.8, 2.0L	EP6987	
Avenir / Renessa W10, W11			05/1990>	L4 SR18, SR20 DE, QG18DE	1.8, 2.0L	EP6987	
Bluebird Turbo	U11		10/1984-10/1989	L4 CA18ET	1.8L	EP6912	
Bluebird	U11		10/1984-10/1989	L4 CA20	2.0L	EP6912	

VEHICLE APPLICATIONS

Make / Model	Series	Body	Year	Type	CC	Pump	Notes
NISSAN cont...							
Bluebird	U11		10/1984-10/1989	V6 VG20	2.0L	EP6912	
Bluebird	U12		10/1989-1992	L4 CA18, CA20	1.8, 2.0L	EP6912	
Bluebird	U12		10/1989-1992	L4 KA24	2.4L	EP6912	
Bluebird	U13		1993-1996	L4 SR18, SR20	1.8, 2.0L	EP6956	Acetal Module
Bluebird	U13		1993-1996	L4 KA24	2.4L	EP6956	Acetal Module
Bluebird	U14		01/1996-1998	L4 SR18,SR20 DE	1.8, 2.0L	EP6958	Acetal Module
Cefiro	A31		09/1988-08/1994	L6 RB20, RB25	2.0, 2.5L	EP6912	
Cefiro	A32		08/1994-1998	V6 VQ20, 25, 30	2.0, 2.5, 3.0L	EP6939	Acetal Module
Fairlady			1984-1989	V6 VG30E	3.0L	EP6912	
Langley	N12		1983-1985	L4 E15	1.5L	EP6910	
Langley	N13		1986-08/1990	L4 GA15	1.5L	EP6912	
Laurel			11/1979-10/1984	L4 Z20	2.0L	EP6910	
Laurel	C33		1989-1992	L6 RB20DE	2.0L	EP6912	
Laurel	C34		1993-1996	L6 RB20E	2.0L	EP6988	
Laurel	C34		1993-1996	L6 RB25DE	2.5L	EP6988	
Maxima	U11		10/1984-10/1988	V6 VG20E	2.0L	EP6912	
Maxima	J30		10/1988-1995	V6 VG30E	3.0L	EP6912	
Maxima	A32		1995-1999	V6 VQ30DE	3.0L	EP6939	Acetal Module
Maxima	A33		2000-2003	V6 VQ30DE	3.0L	EP6995	
Maxima	J31		2003>	V6 VQ35DE	3.5L	EP6995	
Micra			1995-1999	L4 G13DE	1.3L	EP7953	
Navara	D21		1992-1995	L4 Z24	2.4L	EP6912	
Navara	D21		1992-1995	V6 VG30E	3.0L	EP6912	
Navara	D22		1997>	L4 KA24	2.4L	EP6912	
Prairie			1992-1998	L4 SR20DE	2.0L	EP6956	
Pathfinder / Terrano	D21		10/1988-1995	V6 VG30E	3.0L	EP6956	
Pathfinder / Terrano	R50		1995-2004	V6 VG33E	3.3L	EP6939	
Pathfinder	R51		2005>	V6 VQ40	4.0L	EP7952	
Patrol	Y60		1990-1997	L6 TB42E	4.2L	EP6912	
Patrol	Y61		1998-2001	L6 TB45E	4.5L	EP6912	
Presea	R11		1995-1998	L4 SR18DE	1.8L	EP6956	
Primera	P10		02/1990-10/1995	L4 SR18, SR20DE	1.8, 2.0L	EP6956	Acetal Module
Primera	P11		11/1995-04/2001	L4 SR18, SR20DE	1.8, 2.0L	EP6958	Acetal Module
Primera	P12		2001>	L4 QG20DE	2.0L	EP6956	
Primera P12			2001>	L4 QR20DD, QR25DD	2.0, 2.5L	EP7987	
Pulsar	N16		2001>	L4 QG18DE	1.8L	EP6958	
Pulsar	N16		2000>	L4 QG16DE	1.6L	EP6958	
Pulsar / Sentra	N12		1983-1985	L4 E15	1.5L	EP6910	
Pulsar / Sentra	N13		1986-08/1990	L4 GA15, GA16	1.5, 1.6L	EP6912	
Pulsar / Sentra	N14		08/1990-1994	L4 GA16, SR18, SR20E	1.6, 1.8, 2.0L	EP6959	
Pulsar / Sentra	N15		1995-1999	L4 GA15, SR18, SR20E	1.5, 1.8, 2.0L	EP6958	Acetal Module
Regulus	JR50		1995-1997	V6 VG33E	3.3L	EP6939	
Silvia	S13		1991-1993	L4 SR20DE	2.0L	EP6912	
Silvia	S14		1993-1998	L4 SR20DE	2.0L	EP6959	
Skyline	R30		1981-10/1984	L4 L20, L24	2.0, 2.4L	EP6910	
Skyline	R31		11/1984-1989	L6 RB20, RB30	2.0, 3.0L	EP6912	
Skyline	R32		1989-1993	L6 RB20, RB25	2.0, 2.5L	EP6912	
Skyline	R33		1993-1996	L6 RB25	2.5L	EP6939	Acetal Module, 38mm Pump
Skyline	R33		1993-1996	L6 RB20, RB25	2.0, 2.5L	EP6988	51mm Pump
Stanza	T12		1986-1990	L4 CA18, CA20	1.8, 2.0L	EP6912	
Sunny	B12		03/1986-1990	L4 GA15	1.5L	EP6912	
Sunny	B13		01/1990-01/1994	L4 GA16, SR18	1.6, 1.8L	EP6912	
Sunny	B14		1994-1998	L4 GA13DE	1.3L	EP6958	
Sunny	B14, B15		01/1994-1998	L4 GA16, SR18	1.6, 2.0L	EP6958	Acetal Module
Vanette / Serena / Largo	C23		05/1993>	L4 SR20, KA24	2.0, 2.4L	EP6956	Acetal Module
X-Trail	T30		2001>	L4 QR25DE	2.5L	EP6939	
PEUGEOT							
205 GTI OAK	OAK		1986-1991	L4 XU5J1/J/JA/JP	1.6L	EP6971	
206			2001>	L4	1.6, 2.0L	EP7967	
306			1993>	L4	1.8, 2.0L	EP7956	
307			2000>	L4	1.6, 2.0L	EP7934	
309	GL, GR, SR, SRI		1985-1993	L4	1.1, 1.3, 1.4, 1.6, 2.0L	EP6949	
309 GTI	SDB10 CD62		06/1987-04/1992	L4	1.7, 1.9L	EP6949	
405	GL, GR, SR		05/1987-1996	L4	1.9, 2.0L	EP6949	
406			1996>	L4	2.0L	EP7957	
406			1996>	V6	3.0L	EP7958	
505			1979-1985	L4	1.8, 2.0, 2.2L	EP6949	

VEHICLE APPLICATIONS

Make / Model	Series	Body	Year	Type	CC	Pump	Notes
PEUGEOT cont...							
505			1986-1989	L4	2.3, 2.5L	EP6949	
604			1983-1986	V6	2.8L	EP7959	
605			1989-2000	L4	2.1, 2.5L	EP6949	
605			1989-2000	V6	3.0L	EP6949	
607			2001>	V6	3.0L	EP7965	
PONTIAC							
LE MANS			01/1989-03/1992		2.0L	EP6964	
PORSCHE							
911 Carrera			1984-1989	F6	3.2, 3.6L	EP6941	
911 SC			1977-1980	F6	3.0L	EP6945	
911 SC			1980-1983	F6	3.0L	EP6944	
911 Turbo			1977-1995	F6	3.3, 3.6L	EP6944	
911 Turbo			1995>	F6	3.6L	EP6941	
924			1977-1981	4	2.0L	EP6945	
924 Turbo			1980-1982	4	2.0L	EP6944	
928			1978-1982	V8	4.5L	EP6945	
928S			1980-1983	V8	4.7L	EP6944	
928S			1983-1986	V8	4.7L	EP6941	
928 S4 GT			1986-1991	V8	5.0L	EP6941	
944			1982-1989	4	2.5, 2.7L	EP6941	
944 S4			1986-1991	4	2.5L	EP6941	
944 Turbo			1986-1991	4	2.5L	EP6941	
PROTON							
Saga MB5PRO			1987-1991	L4 4G15	1.5L	EP6908	
RENAULT							
R11			1985>	L4	1.4, 1.7L	EP6949	
R19			1986-1992	L4	1.8L	EP6949	
R21, R25			09/1986-1994	L4	1.7, 2.0, 2.2L	EP6949	
R25 & Alpine			11/1984-03/1993	V6	2.0, 2.8L	EP6941	
Clio			2000>	L4	1.4, 1.6L	EP7961	
Clio			2000>	L4	2.0L	EP7962	
Espace			06/1985-1994	L4, V6	2.0, 2.2, 2.8L	EP6949	
Fuego			04/1981-10/1986	L4	1.5, 2.0L	EP6949	
Laguna			1994-2005	L4, V6	2.0, 3.0L	EP7963	
Megane			2001-2004	L4	1.6L	EP7961	
Scenic			2000>	L4	1.6L	EP7966	
ROVER - LANDROVER - RANGEROVER							
214, 216			1991-1996	L4 K Series	1.4, 1.6L	EP6971	
220			1991-1995	L4 T Series	2.0L	EP6971	
3500 SD1			1983-1986	V8	3.5L	EP6925	
416i			05/1986-04/1990	L4 DOHC D16D	1.6L	EP6901	
825/827Si			09/1987-07/1990	V6	2.5L, 2.7L	EP6902	
Land Rover Discovery	Series 1		1991-1999	V8	3.9L	EP6936	Pump Only, OE Module = EP7960M
Range Rover			1985-1989	V8	3.5L	EP6936	Pump Only, OE Module = EP7960M
Range Rover			1989-1994	V8	3.9L	EP7960M	Complete Module
Range Rover Vogue			1986-1991	V8	3.5L, 4.0L	EP6922	
Range Rover Discovery			1992>	V8	4.0L	EP6936	Pump Only, OE Module = EP7960M
Range Rover HSE46			1995-1999	V8 46D	4.6L	EP6936	Pump Only, OE Module = EP7960M
SAAB							
900-9000			1983-1987	L4	2.0, 2.2L	EP5923	L/P Primer Pump
900 GLE 16v			1989-1990	L4 B202	2.0L	EP6925	
9000 GLE 16v			1987-1990	L4 B202	2.0L	EP6925	
9000 CD 16v			1990-1993	L4 B234	2.3L	EP6925	
SUBARU							
Alcyone-Vortex	Turbo	ALL	1985-1987	F4 / 1.8L	EA82T	EP6910	51mm Body
Alcyone-Vortex	VR, VS Turbo 4WD	ALL	1985-1989	F4 / 1.8L	EA82T	EP6910	51mm Body
Alcyone-Vortex	VX 4WD	ALL	1989-1991	F4 / 2.7L	ER27G	EP6910	51mm Body
Alcyone-Vortex	VY 4WD	ALL	1991-1993	F6 / 3.3L	EG33G	EP6920	51mm Body
Forester	SF Non Turbo	ALL	1997-2002	F4 / 2.0L	EJ20	EP6968	38mm Body
Forester	SF Non Turbo	ALL	1997-2002	F4 / 2.5L	EJ25	EP6968	38mm Body

Make / Model	Series	Body	Year	Type	CC	Pump	Notes
SUBARU cont...							
Forester	SF Turbo	ALL	1997-2002	F4 / 2.0L	EJ20T	EP6920	51mm Body
Forester	SG Non Turbo	ALL	2002-2007	F4 / 2.0L	EJ20	EP7985	38mm Body
Forester	SG Non Turbo	ALL	2002-2007	F4 / 2.5L	EJ25	EP7985	38mm Body
Forester	SG Turbo	ALL	2002-2007	F4 / 2.0L	EJ20T	EP7985	38mm Body
Forester	SH Non Turbo	ALL	2008-on	F4 / 2.0L	EJ20	EP7985	38mm Body
Forester	SH Non Turbo	ALL	2008-on	F4 / 2.5L	EJ25	EP7985	38mm Body
Forester	SH Turbo	ALL	2008-on	F4 / 2.0L	EJ20T	EP7985	38mm Body
Impreza	GC, GF	ALL	1993-1996	F4 / 1.8L, 2.0L	EJ18, EJ20	EP6917	51mm Body
Impreza	GC, GF	ALL	1997-2001	F4 / 1.5L, 1.6L	EJ15, EJ16	EP6968	38mm Body
Impreza	GC, GF	ALL	1997-2001	F4 / 1.8L, 2.0L	EJ18, EJ20	EP6968	38mm Body
Impreza	GD, GG	ALL	2001-2007	F4 / 1.5L	EJ15	EP7985	38mm Body
Impreza	GD, GG	ALL	2001-2007	F4 / 2.0L	EJ20	EP7985	38mm Body
Impreza	GD, GG	ALL	2001-2007	F4 / 2.5L	EJ25	EP7985	38mm Body
Impreza	GC, GF	ALL	1993-1996	F4 / 1.5L, 1.6L	EJ15, EJ16	EP6917	51mm Body
Impreza WRX	GC, GF Turbo	ALL	1993-2001	F4 / 2.0L	EJ20T	EP6920	51mm Body
Impreza WRX	GD, GG Turbo	ALL	2001-2007	F4 / 2.0L	EJ20T	EP7985	38mm Body
Legacy	BC, BF Non Turbo	ALL	1989-1994	F4 / 1.8L	EJ18	EP6917	51mm Body
Legacy	BC, BF Non Turbo	ALL	1989-1994	F4 / 2.0L	EJ20	EP6917	51mm Body
Legacy	BC, BF Non Turbo	ALL	1989-1994	F4 / 2.2L	EJ22	EP6917	51mm Body
Legacy	BC, BF Turbo	ALL	1989-1994	F4 / 2.0L	EJ20T	EP6920	51mm Body
Legacy	BD, BG Non Turbo	ALL	1994-1998	F4 / 2.0L	EJ20	EP6968	38mm Body
Legacy	BD, BG Non Turbo	ALL	1994-1998	F4 / 2.2L	EJ22	EP6968	38mm Body
Legacy	BD, BG Non Turbo	ALL	1994-1998	F4 / 2.5L	EJ25	EP6968	38mm Body
Legacy	BD, BG Twin Turbo	ALL	1994-1998	F4 / 2.0L	EJ20TT	EP6982	51mm Body
Legacy	BE, BH Non Turbo	ALL	1998-2000	F4 / 2.0L	EJ20	EP7980	38mm Body
Legacy	BE, BH Non Turbo	ALL	1998-2000	F4 / 2.5L	EJ25	EP7980	38mm Body
Legacy	BE, BH Non Turbo	ALL	2001-2003	F4 / 2.0L	EJ20	EP7980	38mm Body
Legacy	BE, BH Non Turbo	ALL	2001-2003	F4 / 2.5L	EJ25	EP7980	38mm Body
Legacy	BE, BH Non Turbo	ALL	2001-2003	F6 / 3.0L	EZ30D	EP7980	38mm Body
Legacy	BE, BH Twin Turbo	ALL	1998-2000	F4 / 2.0L	EJ20TT	EP6982	51mm Body
Legacy	BE, BH Twin Turbo	ALL	2001-2003	F4 / 2.0L	EJ20TT	EP6982	51mm Body
Legacy	BL, BP Non Turbo	ALL	2003-2008	F4 / 2.0L	EJ20	EP7980	38mm Body
Legacy	BL, BP Non Turbo	ALL	2003-2008	F4 / 2.5L	EJ25	EP7980	38mm Body
Legacy	BL, BP Non Turbo	ALL	2003-2008	F6 / 3.0L	EZ30D	EP7980	38mm Body
Legacy	BL, BP Turbo	ALL	2003-2008	F4 / 2.0L	EJ20T	EP7980	38mm Body
Leone	4WD Turbo	ALL	1984-1989	F4 / 1.8L	EA81T, EA82T	EP6910	External Pump
Omega	JF1A	ALL	1988-1992	F4 / 1.8L	EA82	EP6910	External Pump
Omega	JF1A	ALL	1993-1994	F4 / 1.8L	EA82	EP6920	51mm Body
Omega	Turbo	ALL	1988-1989	F4 / 1.8L	EA82T	EP6910	External Pump
Outback	BE, BH	ALL	1996-2002	F4 / 2.5L	EJ25	EP6920	51mm Body
SVX	Coupe	ALL	1988-1992	F6 / 3.3L	EG33	EP6968	38mm Body
SVX	Coupe	ALL	1992-1997	F6 / 3.3L	EG33	EP6920	51mm Body

WARNING NOTE:

Twin Turbo Subaru applications require a special high performance EFI pump; part number EP6982.

Although EP6917 and EP6920 are similar in appearance their output and pressure is considerably less and could be detrimental to engine performance and life expectancy. EP6920 has higher output pressure than EP6917. We recommend EP6917 be fitted to non turbo applications to retain OE fuel consumption.

As a guide, CDL Autoparts recommend the following:

- EP6917 suits non turbo vehicles
- EP6920 suits single turbo vehicles
- EP6982 suits twin turbo vehicles

Other manufacturers and suppliers may catalogue the same part numbered pump for single turbo, twin turbo and non turbo models. This practise is flawed and dangerous as outlined above.

Cedele supplied EFI pumps have equivalent output and pressure to Genuine OE pumps.

Due to the proliferation of Subaru used imports it is difficult in some models to identify the correct fuel pump. For this reason CDL Autoparts identify the cannister sizes on fuel pumps in the "notes" column of this listing.

VEHICLE APPLICATIONS

Make / Model	Series	Body	Year	Type	CC	Pump	Notes
SUZUKI							
Alto	HA11		1993-1998	L3	0.8L	EP6909	
Alto	SR310		1999>	L4 K10A	1.0L	EP6909	
Baleno			1995>	L4 G16,18	1.6, 1.8L	EP6909	
Jimny	JB32W		1999>	L4 G13B	1.3L	EP6909	
Swift	MA		1996>	L4 G13B	1.3L	EP6909	
Swift	SF413 II		1989-1993	L4 G13B DOHC	1.3L	EP6900	
Swift	SF413 III		10/1989-1994	L4 G16A OHC	1.6L	EP6909	
Vitara / Escudo			1991-1996	L4 G16A EFI	1.6L	EP6997	
Vitara / Escudo	TD62W		1995>	V6 H20A, H25A	2.0L, 2.5L	EP6997	
Vitara Grand / Escudo	FTA03		1997>	L4 G16B, J20A	1.6L, 2.0L	EP6997	
TOYOTA (for alternative import names refer end of Toyota listing)							
Altezza	1GFE		1998	L6	2.0L	EP6931	
Altezza	SXE10		1998-2000	L4 3S-GE	2.0L	EP6931	
Aristo	JZS147		1993-1997	L6 2JZ-GE	3.0L	EP6931	
Avalon			1998-2004	V6 1MZ-FE	3.0L	EP6931	
Caldina	AT191		1996-1997	L4 7A-FE	1.8L	EP6926	
Caldina	AT211		1996-1997	L4 7A-FE	1.8L	EP6926	
Caldina	ET196		1992-1997	L4 5E-FE	1.5L	EP6926	
Caldina	ST190, ST195		1992-9600	L4 3S-FE	2.0L	EP6926	
Caldina	ST210		1996-1998	L4 3S-FE	2.0L	EP6926	
Caldina 4WD Turbo	ST215		1997-1999	L4 3S-GTE	2.0L	EP6926	
Camry	ACV36		2002>	L4 2AZ-FE	2.4L	EP6926	
Camry	SV10, 11, 12, 20, 21		06/1984-1989	L4 1S, 2S, 3S-FE	1.8, 2.0L	EP6900	
Camry	SV30		1990-1994	L4 4S-FE	1.8L	EP6931	
Camry	SV32, 33		1990-1994	L4 3SGE, 3G-FE	2.0L	EP6931	
Camry	SV40		1994-1998	L4 4S-FE	1.8L	EP6931	
Camry	SV41, 42, 43		1990-1996	L4 3S-FE, 5S-FE	2.0, 2.2L	EP6931	
Camry	VCV10		1993-1996	V6 3VZ-FE	3.0L	EP6931	
Camry	VZV20		04/1987-07/1990	V6 1VZ-FEU	2.0L	EP6900	
Camry	VZV30, 31		07/1990-1994	V6 1VZ-FEU	2.0L	EP6931	
Camry	VZV32, 33		1991-1994	V6 4VZ-FE	2.5L	EP6931	
Canib 4WD	AE115		1995-1998	L4 7A-FE	1.8L	EP6926	
Carina	AT191		1994-1997	L4 7A-FE	1.8L	EP6926	
Carina	AT192		1992-1996	L4 5A-FE	1.5L	EP6926	
Carina	AT211		1996-1997	L4 7A-FE	1.8L	EP6926	
Cavalier			1996-1994	L4 T2	2.4, 3.0L	EP6972M	
Cavalier			1995>	L4 T2	2.2, 2.3L	EP6977M	
Celica	GA61, MA45, MA64		07/1981-02/1986	L6 1GEU	2.0L	EP6901	
Celica	ST162, 163, ST170, ST180		05/1985-09/1989	L4 3SFE	2.0L	EP6900	
Celica	ST182, 183, 184, 185		01/1989-10/1993	L4 3S-FE, 5SFE	2.0, 2.2L	EP6926	
Celica	ST202, 203, 205		10/1993-1997	L4 3S-FE, 5SFE	2.0, 2.2L	EP6926	
Celica	TA46, 47, 63		08/1979-08/1985	L4 3TEU, GTEU	1.8L	EP6901	
Celsior	UCF-10		1989-1992	V8 1UZ-FE	4.0L	EP6900	
Chaser	GX, MX		10/1981-1988	L6 MTEU, 1GEU	2.0L	EP6901	
Chaser	GX83		08/1989-10/1992	L6 7MGE	3.0L	EP6931	
Chaser	JZX		08/1990>	L6 1JZ, 2JZ	2.5, 3.0L	EP6931	
Chaser	SX60, SX70		08/1982-08/1988	L4 1S-U	1.8L	EP6901	
Corolla/Sprinter/Canib/FXGT	AE81, AE82, AE 85, AE91, AE92		06/1983-1991	L4 3A, 4AGE	1.5, 1.6L	EP6900	
Corolla/Sprinter/DXE	E80, 90, 96, 97		1985-1987	L4 2E-L SOHC	1.3L	EP6900	
Corolla	AE93		1991-1993	L4 7AFE	1.8L	EP6926	
Corolla Sprinter	AE110		1995-1999	L4 5AFE	1.5L	EP6926	
Corolla	AE101		1991-1994	L4 4A-GZE	1.6L	EP6926	
Corolla	AE101, 102, 104, 111		06/1991>	L4 4A-GE, 4AFE	1.6L	EP6926	
Corolla	EE100, 101, 102, 103, 104, 107		06/1991-1998	L4 2E, 3E	1.3, 1.5L	EP6926	
Corolla	EE108G		1991-1994	L4 3E	1.5L	EP6926	
Corolla	EE111		1995-1999	L4 4E-FE	1.3L	EP6926	
Corolla	ST170		1988-1992	L4 4S-F	1.8L	EP6900	
Corolla	ZZE128		2001>	L4 1ZZ-FE	1.8L	EP6926	
Corolla II	EL30		1986-1990	L4 2E-E	1.3L	EP6900	
Corolla II	EL41		1990-1994	L4 4E-FE	1.3L	EP6926	
Corolla II	EL43		1990-1994	L4 5E-FHE, FE	1.5L	EP6926	
Corolla II	EL51		1994-1998	L4 4E-FE	1.3L	EP6926	
Corolla II	EL53		1994-1998	L4 5E-FE	1.5L	EP6926	
Corona	ST180		1991-1995	L4 4S-F	1.8L	EP6900	
Corona	ST180		1990-1993	L4 4S-FE	1.8L	EP6926	
Corona	ST190, 191, 202		1991-1994	L4 4S-FE, 3SFE	1.8, 2.0L	EP6926	
Corona	ST200		1993-1997	L4 4S-FE	1.8L	EP6926	

VEHICLE APPLICATIONS

Make / Model	Series	Body	Year	Type	CC	Pump	Notes
TOYOTA (for alternative import names refer end of Toyota listing) cont...							
Corona	ST210		1996-1998	L4 3S-FE	2.0L	EP6926	
Corona/Carina	ST150, 151, 160, 162		10/1983-1990	L4 1S, 2S, 3SGE	1.8, 2.0L	EP6900	
Corona/Carina	ST170, 171, 182, 183		12/1987-1990	L4 4S-F, 3SGE	1.8, 2.0L	EP6900	
Corona/Carina	AT190		02/1992-1996	L4 4AFE	1.6L	EP6926	
Corona	AT211		1996-1997	L4 7A-FE	1.8L	EP6926	
Corsa	EL53		1994-1998	L4 5E-FE	1.5L	EP6926	
Cressida	GX60, 70, 71, 81		1981-1985	L6 1G-EU, 5MGE	2.0, 2.8L	EP6901	
Cressida	JZX		08/1990-1992	L6 1JZ-GE	2.5L	EP6900	
Cressida	MX62, 73, 83		1986-1989	L6 5MGE, 7MGE	2.8, 3.0L	EP6900	
Cressida/Chaser	GX90		1992-1996	L6 1G-FE	2.0L	EP6931	
Cressida/Chaser	JZX90		1992-1996	L6 1JZ-FE	2.5L	EP6931	
Cressida/Chaser	SX80		1988-1990	L4 4S-FI	1.8L	EP6900	
Crown	JZS, JZS147		11/1991-1997	L6 2JZ-GE	3.0L	EP6931	
Crown	UZ5		11/1991>	V8 1UZ-FE	4.0L	EP6965	
Cynos/Paseo	EL52, 44		01/1991>	L4 4EFE, 5E	1.3, 1.5L	EP6926	
Cyren	ST206		1994-1996	L4 3SFE	2.0L	EP6926	
Hilux/Surf/4 Runner	RZN, VZN		08/1990>	V6 3VZ, 5VZ	3.0, 3.4L	EP6900	
Hilux/Surf/4 Runner	YN Series		1987-1990	L4 2Y, 3Y, 4Y	1.8, 2.0, 2.2L	EP6965	
Hilux 2WD	RZN185		1996>	L4 3RZ-FE	2.7L	EP6926	
Hilux 4WD	RZN185		1995>	L4 3RZ-FE	2.7L	EP6926	
Ipsum	SXM10		1996-2000	L4 3S-FE	2.0L	EP6926	
Landcruiser	FJ70 BJ Series		1992-1996	L6 1FZ-FE	4.5L	EP6931	
Landcruiser	FJ80 FJ Series		1987-1992	L6 3FE	4.0L	EP6965	
Liteace/Townace	YR21G, 26G, 30G		10/1985>	L4 3Y	2.0L	EP6900	
MR2	AW11		06/1984-10/1989	L4 4A-GE DOHC	1.6L	EP6965	
MR2	SW20		1989-1999	L4 3S-GE	2.0L	EP6926	
MR2	ZZW30R		2000>	L4	2.0L	EP6926	
Prado	VZJ 90, 95		1992>	V6 5VZ-FE	3.4L	EP6931	38mm Pump
Previa	ACR30		2001>	L4	2.4L	EP6926	
Previa	TCR10R, 11R		1994>	L4 2TZ-FE	2.4L	EP6926	
RAV4	ACA20, ACA21		2000>	L4 1AZ-FE	2.0L	EP6926	
RAV 4WD	SXA10G, 11G		04/1994-1999	L4 3SFE	2.0L	EP6926	
Soarer	JZZ30, JZZ31		05/1991>	L6 1JZ, 2JZ	2.4, 3.0L	EP6926	
Sprinter 4WD	AE115		1995-1998	L4 7A-FE	1.8L	EP6926	
Starlet	EP71, EP76V		10/1984-10/1989	L4 2E	1.3L	EP6900	
Starlet	EP81, 82, 85, 90, 91, 95		1991-1996	L4 2E, 4EFE	1.3, 1.4L	EP6926	
Starlet Turbo	EP82		1991-1995	L4 4EFT	1.3L	EP6926	
Supra	GA70		02/1986-08/1990	L6 1G-EU	2.0L	EP6965	
Supra	JZA80		05/1993-1994	V6 2JZ-GE	3.0L	EP6931	
Supra	MA61, MA70		03/1986-08/1990	L6 5M-E, 7MGE	2.8, 3.0L	EP6965	
Supra Twin Turbo			1994-1996	L6 2JZ-GTE	3.0L	EP6933	OE Pump
Tarago RV 4WD	YR22		05/1990>	L4 4YEC	2.2L	EP6926	
Tarago	TCR10, 11		1994-2000	L4 2TZ-FE	2.4L	EP6926	
Tarago	TCR10, 20, 21		1990-1994	L4 2TZ-FE	2.4L	EP6900	
Tarago	YR20, 30, 31		1986-1991	L4 3Y	2.0L	EP6900	
Tarago Efi	YR22		1985-1990	L4	2.2L	EP6900	
Tercel	AL20, EL30, 31		05/1986-09/1990	L4 2E, 3E	1.3, 1.5L	EP6900	
Tercel	EL41		1990-1994	L4 4E-FE	1.3L	EP6926	
Tercel	EL43		1990-1994	L4 5E-FHE	1.5L	EP6965	
Tercel	EL53		1994-1998	L4 5E-FE	1.5L	EP6926	
Townace Efi	KR42R		1998>	L4	1.8L	EP6909	
Vienta	MCV20R, VCV10R		1995>	V6	3.0L	EP6931	
Vista	SV40		1994-1998	L4 4S-FE	1.8L	EP6931	
Vista	SV41		1994-1998	L4 3S-FE	2.0L	EP6931	
Windom	VCV10		1991-1996	V6	3.0L	EP6931	
TOYOTA IMPORT VEHICLES CROSS REFERENCE NAMES							
4 Runner			refer	Hilux	Masterace		refer Liteace
Aristo			refer	Crown	Microbus		refer Coaster
Carib			refer	Corolla	Noah		refer Liteace
Caldina			refer	Corona	Paseo		refer Corolla
Canina			refer	Corona	Prado		refer Landcruiser
Ceres			refer	Corolla	Premio		refer Corona
Chaser			refer	Corona Mk2	Promnent		refer Camry
Commutor			refer	Microbus/Coaster	Sera		refer Corolla
Corsa			refer	Corolla	Sceptre		refer Camry
Cressida			refer	Corona Mk2	Sprinter		refer Corolla
Cresta			refer	Corona	Surf		refer Hilux

Pump Number	Pump Location	Body Size (mm)	Pressure	Strainer Included	Vehicle Applications
EP5906	IT	37	L	√	Ford Priming Pump
EP5907	IT	37	L	√	Ford Priming Pump
EP5908	IT	37	L	√	Ford Midtank Priming Pump
EP5919	IT	32	L	√	Ford Midtank Priming Pump
EP5920	IT	37	L	√	Commodore Priming Pump, Volvo
EP5921	IT	37	L	√	Rover-Volvo Priming Pump
EP5923	IT	37	L	√	Saab
EP6900	IT	51	H	√	Daihatsu, Ford, Holden, Isuzu, Mazda, Toyota, Suzuki
EP6901	EX	47	H	N/R	Daihatsu, Ford, Honda, Mazda, Mitsubishi, Rover, Toyota
EP6902	IT	51	H	√	Honda, Rover
EP6903	IT	37	H	√	Chev-BMW
EP6904	IT	38	H	√	Honda
EP6905	IT	38	H	√	Honda
EP6906	EX	47	H	N/R	Universal multipoint performance pump
EP6907	EX	47	H	N/R	Universal multipoint performance pump
EP6908	IT	51	H	√	Mitsubishi, Proton
EP6909	IT	38	H	√	Daihatsu, Ford, Holden, Honda, Hyundai, Mazda, Mitsubishi, Subaru, Suzuki
EP6910	EX	47	H	N/R	Nissan, Subaru, Isuzu
EP6911	IT	51	H	√	Nissan
EP6912	IT	51	H	√	Nissan
EP6913	IT	38	H	√	Holden
EP6914	IT	51	H	√	Holden, Isuzu
EP6915	IT	60	H	N/R	Audi, Mercedes Benz
EP6916	EX	47	H	N/R	Jaguar, Volvo
EP6917	IT	51	H	√	Subaru (non turbo)
EP6918	EX	47	H	N/R	Jaguar Series III XJ
EP6919	IT	51	H	√	Honda
EP6920	IT	51	H	√	Subaru Single Turbo
EP6921	EX	47	M	N/R	Universal TBI Pump
EP6922	IT	37	H	√	Jeep, Rover, Renault
EP6923	IT	37	H	√	Holden VG-VS, V6-V8, Chev, Ford Sierra
EP6924	EX	47	H	N/R	GM, Volvo
EP6925	EX	47	H	N/R	Universal Multipoint Pump
EP6926	IT	38	H	√	Toyota, Lexus
EP6927	IT	43	H	√	Ford
EP6928	IT	37	M	√	Ford CFI
EP6929	IT	37	H	√	Ford
EP6930	IT	43	H	√	Ford
EP6931	IT	38	H	√	Toyota, Lexus
EP6932	IT	47	H	√	Jeep
EP6933	IT	51	H	√	Mazda RX7 including Turbo, Lexus
EP6934	IT	45	H	√	Commodore VT, VX, V6-V8, Ford
EP6935	EX	47	H	N/R	Ford F150, 250, 350
EP6936	IT	37	H	√	Rangerover
EP6937M	IT	-	H	OE MODULE	Ford Taurus
EP6938	IT	38	H	√	Ford, Mazda
EP6939	IT	38	H	√	Nissan
EP6940	EX	47	H	N/R	Jaguar, Daimler, Volvo
EP6941	EX	47	H	N/R	Alfa, Fiat, Porsche, Renault, Volvo

Pump Number	Pump Location	Body Size (mm)	Pressure	Strainer Included	Vehicle Applications
EP6942	EX	47	H	N/R	Mercedes Benz
EP6943	EX	47	H	N/R	Ford, Mercedes Benz
EP6944	EX	47	H	N/R	Audi, BMW, Porsche, Renault, Volvo, VW
EP6945	EX	47	H	N/R	BMW, Mercedes Benz, Peugeot, Porsche
EP6946	EX	47	H	N/R	Volvo
EP6947	EX	47	H	N/R	Ferrari, Ford, Mercedes Benz
EP6948	EX	52	H	N/R	Audi, Ford, Mercedes Benz, Triumph
EP6949	EX	47	H	N/R	Alfa, BLMC, BMW, Citroen, Fiat, Jaguar, Peugeot, Renault, VW
EP6950	IT	37	M	√	Chevrolet TBI
EP6951	IT	37	H	√	Hyundai
EP6952	IT	37	H	√	Hyundai
EP6953	IT	37	H	√	Jaguar XJ
EP6954	IT	38	H	√	Ford Explorer
EP6955	IT	38	H	√	Ford Expedition
EP6956	IT	51	H	√	Nissan
EP6957	IT	47	H	√	Triumph TR7
EP6958	IT	38	H	√	Nissan
EP6959	IT	51	H	√	Nissan
EP6960M	IT	-	H	OE MODULE	Commodore VT Chev Engine
EP6961	IT	50	H	√	Ford Falcon AU
EP6962	IT	38	H	√	Kia Mentor
EP6963	IT	38	H	√	Kia Sportage
EP6964	IT	37	M	√	Pontiac LeMans
EP6965	IT	51	H	√	Toyota Turbo, Toyota H.P., Lexus, Mitsubishi
EP6966	IT	51	H	√	Universal High Performance
EP6967	IT	37	H	√	Corvette
EP6968	IT	38	H	√	Subaru
EP6969M	IT	-	H	OE MODULE	Chrysler Neon
EP6970M	IT	-	H	OE MODULE	Chrysler Voyager
EP6971	IT	37	H	√	Rover 214, Peugeot
EP6972M	IT	-	H	OE MODULE	Toyota Cavalier
EP6973	IT	37	H	√	Peugeot, Multiple European
EP6974M	IT	-	H	OE MODULE	Daewoo
EP6975	IT	-	H	√	Daewoo
EP6976M	IT	-	h	OE MODULE	Daewoo
EP6977M	IT	-	H	OE MODULE	Toyota Cavalier
EP6978	IT	41	H	√	Mercuriser - Volvo
EP6979	IT	43	H	√	BMW
EP6980	IT	37	H	√	BMW
EP6981M	IT	-	H	OE MODULE	Ford F100
EP6982	IT	51	H	√	Subaru Twin Turbo OE Pump
EP6983M	IT	-	H	OE MODULE	Chrysler-Jeep
EP6984HD	EX	47	H	N/R	Marine Heavy Duty
EP6985M	IT	-	H	OE MODULE	Marine and GMC
EP6986M	IT	-	H	OE MODULE	Holden VT, VX V6 Supercharged
EP6987	IT	51	H	√	Nissan
EP6988	IT	51	H	√	Nissan
EP6989	IT	38	H	√	Mazda
EP6990M	IT	-	H	OE MODULE	Ford, Mazda

Pump Number	Pump Location	Body Size (mm)	Pressure	Strainer Included	Vehicle Applications
EP6991M	IT	-	H	OE MODULE	Camaro
EP6992M	IT	-	H	OE MODULE	Chevrolet S10 2 Door
EP6993M	IT	-	H	OE MODULE	Chevrolet S10 4 Door
EP6994	EX	43	H	N/R	Mercedes Benz
EP6995	IT	38	H	√	Nissan
EP6996	IT		H	√	Mustang
EP6997	IT	38	H	√	Suzuki
EP6998	IT	38	H	√	Chrysler Jeep
EP6999	IT	38	H	√	Chrysler Jeep
EP7900M	IT	-	H	OE MODULE	Holden
EP7901M	IT	-	H	OE MODULE	Ford
EP7902M	IT	-	H	OE MODULE	Ford
EP7903M	IT	-	H	OE MODULE	Ford
EP7904M	IT	-	H	OE MODULE	Ford
EP7905M	IT	-	H	OE MODULE	Ford
EP7906M	IT	-	H	OE MODULE	Ford
EP7907M	IT	-	H	OE MODULE	Holden
EP7908M	IT	-	H	OE MODULE	Ford
EP7909M	IT	-	H	OE MODULE	Holden
EP7910M	IT	-	H	OE MODULE	Holden
EP7911M	IT	-	H	OE MODULE	Holden
EP7912M	IT	-	H	OE MODULE	Holden
EP7913M	IT	-	H	OE MODULE	Holden
EP7914M	IT	-	H	OE MODULE	Holden
EP7915M	IT	-	H	OE MODULE	Holden
EP7916M	IT	-	H	OE MODULE	Holden
EP7917M	IT	-	H	OE MODULE	Holden
EP7918M	IT	-	H	OE MODULE	Holden
EP7919M	IT	-	H	OE MODULE	Holden
EP7920M	IT	-	H	OE MODULE	Holden
EP7921M	IT	-	H	OE MODULE	Ford
EP7922	IT	38	H	√	Daewoo
EP7923M	IT	-	H	OE MODULE	Holden
EP7924M	IT	-	H	OE MODULE	Holden
EP7925M	IT	-	H	OE MODULE	Holden
EP7926	IT	43	H	√	Audi
EP7927	IT	51	H	OE MODULE	Audi, VW
EP7928M	IT	43	H	√	GMH
EP7929	EX	43	H	N/R	Ford
EP7930	IT	43	H	N/R	BMW
EP7931	IT	-	H	HANGER ASSY	BMW
EP7932	IT	-	H	HANGER ASSY	BMW
EP7933	EX	43	H	N/R	BMW
EP7934M	IT	-	H	OE MODULE	Citroen, Peugeot
EP7935M	IT	-	H	OE MODULE	Citroen
EP7936M	IT	-	H	OE MODULE	Citroen
EP7937M	IT	-	H	OE MODULE	Citroen

Pump Number	Pump Location	Body Size (mm)	Pressure	Strainer Included	Vehicle Applications
EP7938	IT	37	H	√	Daewoo
EP7939	IT	38	H	√	Jaguar
EP7940M	IT	-	H	OE MODULE	Daewoo
EP7941M	IT	-	H	OE MODULE	Daewoo
EP7942M	IT	-	H	OE MODULE	Jaguar
EP7943	IT	38	H	√	Ford
EP7944M	IT	-	H	OE MODULE	Ford
EP7945M	IT	-	H	OE MODULE	BMW
EP7946	IT	38	H	√	Ford
EP7947	IT	43	H	√	Holden
EP7948M	IT	-	H	OE MODULE	Holden
EP7949M	IT	-	H	OE MODULE	Holden
EP7950	EX	50	H	N/R	Jaguar
EP7951	IT	-	H	HANGER ASSY	Kia
EP7952	IT	38	H	√	Nissan
EP7953	IT	51	H	√	Nissan
EP7954	IT	43	H	√	VW
EP7955M	IT	-	H	OE MODULE	VW
EP7956M	IT	-	H	OE MODULE	Peugeot
EP7957M	IT	-	H	OE MODULE	Peugeot
EP7958M	IT	-	H	OE MODULE	Peugeot
EP7959	EX	50	H	N/R	Peugeot
EP7960M	IT	-	H	OE MODULE	Rover
EP7961M	IT	-	H	OE MODULE	Renault
EP7962M	IT	-	H	OE MODULE	Renault
EP7963M	IT	-	H	OE MODULE	Renault
EP7964	IT	-	H	HANGER ASSY	Kia
EP7965M	IT	-	H	OE MODULE	Peugeot
EP7966	IT	43	H	√	Renault
EP7967M	IT	-	H	OE MODULE	Holden
EP7968	IT	38	H	√	Holden Rodeo
EP7969M	IT	-	H	OE MODULE	Holden Epica
EP7970M	IT	-	H	OE MODULE	Holden
EP7971M	IT	-	H	OE MODULE	Holden
EP7972	IT	-	H	√	Holden
EP7973	IT	-	H	√	Holden
EP7974M	IT	-	H	OE MODULE	Holden
EP7975	IT	-	H	√	Holden
EP7976	IT	-	H	√	Holden
EP7977M	IT	-	H	OE MODULE	Holden
EP7978M	IT	-	H	OE MODULE	Chevrolet
EP7979M	IT	-	H	OE MODULE	Chevrolet
EP7980M	IT	-	H	OE MODULE	Holden - Chev - Suburban

















WHERE A REPLACEMENT PUMP BODY IS SMALLER IN DIAMETER THAN THE ORIGINAL PUMP, A SPACER SLEEVE IS PROVIDED.

REFER PAGES 28 to 39 FOR ILLUSTRATIONS/PUMP STYLES

<p>EP5906</p>  <p>FORD Correct Strainer Supplied</p>	<p>EP5907</p>  <p>FORD Correct Strainer Supplied</p>	<p>EP5908</p>  <p>FORD Correct Strainer Supplied</p>	<p>EP5919</p>  <p>FORD Correct Strainer Supplied</p>
<p>EP5920</p>  <p>HOLDEN - VOLVO Correct Strainer Supplied</p>	<p>EP5921</p>  <p>ROVER V8 Correct Strainer Supplied</p>	<p>EP5922</p>  <p>TOYOTA-MITSUBISHI</p>	<p>EP5923</p>  <p>SAAB Correct Strainer Supplied</p>
<p>EP6900</p>  <p>FORD MAZDA TOYOTA Correct Strainer Supplied</p>	<p>EP6901</p>  <p>UNIVERSAL JAPAN</p>	<p>EP6902</p>  <p>HONDA Correct Strainer Supplied</p>	<p>EP6903</p>  <p>CHEVROLET Correct Strainer Supplied</p>
<p>EP6904</p>  <p>HONDA Correct Strainer Supplied</p>	<p>EP6905</p>  <p>HONDA Correct Strainer Supplied</p>	<p>EP6906</p>  <p>UNIVERSAL MPI</p>	<p>EP6907</p>  <p>UNIVERSAL MPI HIGH PERFORMANCE</p>

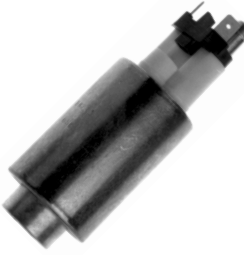





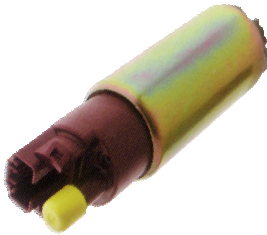

<p>EP6908</p>  <p>MITSUBISHI Correct Strainer Supplied</p>	<p>EP6909</p>  <p>FORD HONDA MAZDA MITSUBISHI Correct Strainer Supplied</p>	<p>EP6910</p>  <p>NISSAN</p>	<p>EP6911</p>  <p>NISSAN</p>
<p>EP6912</p>  <p>NISSAN Correct Strainer Supplied</p>	<p>EP6913</p>  <p>ASTRA BARINA VECTRA Correct Strainer Supplied</p>	<p>EP6914</p>  <p>RODEO Correct Strainer Supplied</p>	<p>EP6915</p>  <p>AUDI K-JET</p>
<p>EP6916</p>  <p>JAGUAR - VOLVO</p>	<p>EP6917</p>  <p>SUBARU NON TURBO Correct Strainer Supplied</p>	<p>EP6918</p>  <p>JAGUAR</p>	<p>EP6919</p>  <p>HONDA NSX Correct Strainer Supplied</p>
<p>EP6920</p>  <p>SUBARU SINGLE TURBO Correct Strainer Supplied</p>	<p>EP6921</p>  <p>UNIVERSAL T.B.I.</p>	<p>EP6922</p>  <p>RANGEROVER - JEEP Correct Strainer Supplied</p>	<p>EP6923</p>  <p>GMH CHEVROLET Correct Strainer Supplied</p>

<p>EP6924</p>  <p>BMW CADILLAC VOLVO</p>	<p>EP6925</p>  <p>UNIVERSAL MPI</p>	<p>EP6926</p>  <p>TOYOTA Correct Strainer Supplied</p>	<p>EP6927</p>  <p>FORD Correct Strainer Supplied</p>
<p>EP6928</p>  <p>FORD Correct Strainer Supplied</p>	<p>EP6929</p>  <p>FORD Correct Strainer Supplied</p>	<p>EP6930</p>  <p>FORD Correct Strainer Supplied</p>	<p>EP6931</p>  <p>TOYOTA Correct Strainer Supplied</p>
<p>EP6932</p>  <p>JEEP</p>	<p>EP6933</p>  <p>MAZDA RX7 Correct Strainer Supplied</p>	<p>EP6934</p>  <p>HOLDEN - FORD Correct Strainer Supplied</p>	<p>EP6935</p>  <p>FORD</p>
<p>EP6936</p>  <p>RANGEROVER Correct Strainer Supplied</p>	<p>EP6937M</p>  <p>FORD TAURUS</p>	<p>EP6938</p>  <p>FORD - MAZDA Correct Strainer Supplied</p>	<p>EP6939</p>  <p>NISSAN Correct Strainer Supplied</p>

EP6940	EP6941	EP6942	EP6943
 DAIMLER JAGUAR VOLVO	 ALFA FIAT PORCHE VOLVO	 MERCEDES BENZ	 Inlet 15mm push on. Outlet 8mm push on. FORD MERCEDES BENZ
EP6944	EP6945	EP6946	EP6947
 AUDI RENAULT VW VOLVO	 BMW MERCEDES PEUGEOT	 VOLVO	 FERRARI FORD MERCEDES
EP6948	EP6949	EP6950	EP6951
 AUDI FORD MERCEDES TRIUMPH PI	 ALFA BMW FIAT JAGUAR	 CHEVROLET TBI Correct Strainer Supplied	 HYUNDAI Correct Strainer Supplied
EP6952	EP6953	EP6954	EP6955
 HYUNDAI Correct Strainer Supplied	 JAGUAR Correct Strainer Supplied	 FORD Correct Strainer Supplied	 FORD Correct Strainer Supplied

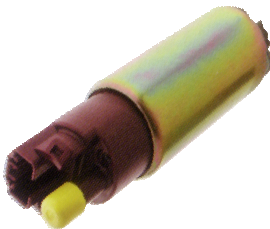
<p>EP6956</p>	<p>EP6957</p>	<p>EP6958</p>	<p>EP6959</p>
 <p>NISSAN Correct Strainer Supplied</p>	 <p>TRIUMPH TR7</p>	 <p>NISSAN Correct Strainer Supplied</p>	 <p>NISSAN Correct Strainer Supplied</p>
<p>EP6960M</p>	<p>EP6961</p>	<p>EP6962</p>	<p>EP6963</p>
 <p>HOLDEN - CHEVROLET</p>	 <p>FORD</p>	 <p>KIA Correct Strainer Supplied</p>	 <p>KIA Correct Strainer Supplied</p>
<p>EP6964</p>	<p>EP6965</p>	<p>EP6966</p>	<p>EP6967</p>
 <p>PONTIAC Correct Strainer Supplied</p>	 <p>TOYOTA MITSUBISHI Correct Strainer Supplied</p>	 <p>UNIVERSAL INTANK HP Correct Strainer Supplied</p>	 <p>CORVETTE Correct Strainer Supplied</p>
<p>EP6968</p>	<p>EP6969M</p>	<p>EP6970M</p>	<p>EP6971</p>
 <p>SUBARU Correct Strainer Supplied</p>	 <p>CHRYSLER NEON</p>	 <p>CHRYSLER VOYAGER</p>	 <p>ROVER 214K Correct Strainer Supplied</p>

<p>EP6972M</p>  <p>TOYOTA CAVALIER</p>	<p>EP6973</p>  <p>PEUGEOT MULTIPLE EUROPEAN</p>	<p>EP6974M</p>  <p>DAEWOO</p>	<p>EP6975</p>  <p>DAEWOO</p>
<p>EP6976M</p>  <p>DAEWOO</p>	<p>EP6977M</p>  <p>TOYOTA CAVALIER</p>	<p>EP6978</p>  <p>MERCUISER V6 MARINE</p>	<p>EP6979</p>  <p>BMW Correct Strainer Supplied</p>
<p>EP6980</p>  <p>BMW Correct Strainer Supplied</p>	<p>EP6981M</p>  <p>FORD</p>	<p>EP6982</p>  <p>SUBARU TWIN TURBO Correct Strainer Supplied</p>	<p>EP6983M</p>  <p>JEEP</p>
<p>EP6984HD</p>  <p>MARINE HEAVY DUTY</p>	<p>EP6985M</p>  <p>MARINE AND GMC.</p>	<p>EP6986M</p>  <p>HOLDEN</p>	<p>EP6987</p>  <p>NISSAN Correct Strainer Supplied</p>

<p>EP6988</p>	<p>EP6989</p>	<p>EP6990M</p>	<p>EP6991M</p>
 <p>NISSAN Correct Strainer Supplied</p>	 <p>FORD MAZDA Correct Strainer Supplied</p>	 <p>FORD MAZDA</p>	 <p>CHEV CAMARO</p>
<p>EP6992M</p>	<p>EP6993M</p>	<p>EP6994</p>	<p>EP6995</p>
 <p>CHEVROLET S10 V6</p>	 <p>CHEVROLET S10 V6</p>	 <p>MERCEDES</p>	 <p>NISSAN Correct Strainer Supplied</p>
<p>EP6996</p>	<p>EP6997</p>	<p>EP6998</p>	<p>EP6999</p>
 <p>FORD MUSTANG Correct Strainer Supplied</p>	 <p>SUZUKI Correct Strainer Supplied</p>	 <p>CHRYSLER JEEP Correct Strainer Supplied</p>	 <p>CHRYSLER JEEP Correct Strainer Supplied</p>
<p>EP7900M</p>	<p>EP7901M</p>	<p>EP7902M</p>	<p>EP7903M</p>
 <p>HOLDEN</p>	 <p>FORD</p>	 <p>FORD</p>	 <p>FORD</p>

<p>EP7904M</p>	<p>EP7905M</p>	<p>EP7906M</p>	<p>EP7907M</p>
			
<p>FORD</p>	<p>FORD</p>	<p>FORD</p>	<p>GMH</p>
<p>EP7908M</p>	<p>EP7909M</p>	<p>EP7910M</p>	<p>EP7911M</p>
			
<p>FORD</p>	<p>HOLDEN</p>	<p>HOLDEN</p>	<p>HOLDEN</p>
<p>EP7912M</p>	<p>EP7913M</p>	<p>EP7914M</p>	<p>EP7915M</p>
			
<p>HOLDEN</p>	<p>HOLDEN</p>	<p>HOLDEN</p>	<p>HOLDEN</p>
<p>EP7916M</p>	<p>EP7917M</p>	<p>EP7918M</p>	<p>EP7919M</p>
			
<p>HOLDEN</p>	<p>HOLDEN</p>	<p>HOLDEN</p>	<p>HOLDEN</p>

<p>EP7920M</p>	<p>EP7921M</p>	<p>EP7922</p>	<p>EP7923M</p>
			
<p>HOLDEN</p>	<p>FORD</p>	<p>DAIHATSU Correct Strainer Supplied</p>	<p>HOLDEN</p>
<p>EP7924M</p>	<p>EP7925M</p>	<p>EP7926</p>	<p>EP7927</p>
			
<p>HOLDEN</p>	<p>HOLDEN</p>	<p>AUDI Correct Strainer Supplied</p>	<p>AUDI VW Correct Strainer Supplied</p>
<p>EP7928M</p>	<p>EP7929</p>	<p>EP7930</p>	<p>EP7931</p>
			
<p>HOLDEN Correct Strainer Supplied</p>	<p>BMW Correct Strainer Supplied</p>	<p>BMW Correct Strainer Supplied</p>	<p>BMW Correct Strainer Supplied</p>
<p>EP7932</p>	<p>EP7933</p>	<p>EP7934M</p>	<p>EP7935M</p>
			
<p>BMW Correct Strainer Supplied</p>	<p>BMW Correct Strainer Supplied</p>	<p>CITROEN PEUGEOT</p>	<p>CITROEN</p>

<p>EP7936M</p>	<p>EP7937M</p>	<p>EP7938</p>	<p>EP7939</p>
 <p>CITROEN</p>	 <p>CITROEN</p>	 <p>DAEWOO</p>	 <p>JAGUAR</p>
<p>EP7940M</p>	<p>EP7941M</p>	<p>EP7942M</p>	<p>EP7943</p>
 <p>DAEWOO</p>	 <p>DAEWOO</p>	 <p>BMW</p>	 <p>FORD FOCUS</p>
<p>EP7944M</p>	<p>EP7945M</p>	<p>EP7946</p>	<p>EP7947</p>
 <p>FORD</p>	 <p>BMW Correct Strainer Supplied</p>	 <p>FORD Correct Strainer Supplied</p>	 <p>HOLDEN Correct Strainer Supplied</p>
<p>EP7948M</p>	<p>EP7949M</p>	<p>EP7950</p>	<p>EP7951</p>
 <p>HOLDEN</p>	 <p>HOLDEN</p>	 <p>JAGUAR</p>	 <p>KIA Correct Strainer Supplied</p>

EP7952	EP7953	EP7954	EP7955M
 <p>NISSAN Correct Strainer Supplied</p>	 <p>NISSAN Correct Strainer Supplied</p>	 <p>VOLKSWAGON Correct Strainer Supplied</p>	 <p>VOLKSWAGON</p>
EP7956M	EP7957M	EP7958M	EP7959
 <p>PEUGEOT</p>	 <p>PEUGEOT</p>	 <p>PEUGEOT</p>	 <p>PEUGEOT</p>
EP7960M	EP7961M	EP7962M	EP7963M
 <p>ROVER</p>	 <p>RENAULT</p>	 <p>RENAULT</p>	 <p>RENAULT</p>
EP7964	EP7965M	EP7966	EP7967M
 <p>KIA Correct Strainer Supplied</p>	 <p>PEUGEOT</p>	 <p>RENAULT Correct Strainer Supplied</p>	 <p>PEUGEOT</p>

EP7968	EP7969M	EP7970M	EP7971M
 <p>HOLDEN RODEO Correct Strainer Supplied</p>	<p>No Photo Available</p> <p>HOLDEN EPICA</p>	 <p>HOLDEN</p>	<p>No Photo Available</p> <p>HOLDEN</p>
EP7972	EP7973	EP7974M	EP7975
 <p>HOLDEN</p>	 <p>HOLDEN ASTRA, COMBO, BARINA TBI</p>	 <p>HOLDEN</p>	<p>No Photo Available</p> <p>HOLDEN</p>
EP7976	EP7977M	EP7978M	EP7979M
 <p>HOLDEN</p>	<p>No Photo Available</p> <p>HOLDEN</p>	<p>No Photo Available</p> <p>CHEV SILVERADO, TCF MODULE CODE 2 PLUGS</p>	<p>No Photo Available</p> <p>CHEV SILVERADO, TCU MODULE CODE 2 PLUGS</p>
EP7980M	EP7981	EP7982	EP7983
 <p>HOLDEN SUBURBAN</p>	<p>No Photo Available</p> <p>MITSUBISHI EVO</p>	<p>No Photo Available</p> <p>DAEWOO</p>	<p>No Photo Available</p> <p>SAAB</p> <p>EP7984 - Onward</p> <p>Photos unavailable at time of printing</p>

