



ADW SPORTS

SPORTS & ENTERTAINMENT DIVISION OF
ADMIRALWORLD GENERAL TRADING LLC

IMPATIA®

COLLECTION CATALOGUE

2024



A Beautiful Way to Have Fun



Reinventing the Classics	1
Our vision	3
Tailor Made in Italy	4
Game Tables	
Filotto	8
Lungolinea	24
Scivolo	38
Derby	44
Unootto	54
Tuttuno	64
Games and Accessories	
Lancio	72
Tocco	74
Verso	76
Game sets	78
Precious Leather Collection	83
IMPATIA and Creative Team	87
Creative Direction	89
The Designers	90
Technical Information	93
Terms and Conditions	125
Contact	126



Reinventing the Classics



Our Vision

REINVENTING THE CLASSICS

Located in the heart of the Milan district, known for its iconic fashion and design influences, Impatia embodies creativity and a flair for design in everything it does. Uniting the traditions of Italian design, art and craftsmanship to produce bespoke luxury game tables. At its core, Impatia manifests the principle of daring, distinct design that is destined to become a true classic. At Impatia each creation is a tale of excellence, driven by the core value of empathy.

Nata nel cuore del distretto produttivo di Milano, noto in tutto il mondo per le sue influenze nei campi della moda e del design, Impatia incarna l'estro creativo in ogni sua proposta. I suoi preziosi tavoli da gioco sono il risultato della tradizione del design, unita all'arte e all'artigianato italiano. L'anima di Impatia è sintetizzata nei principi del design audace e distinto, e destinata a diventare un vero classico. In Impatia ogni creazione è un racconto di eccellenza, guidato dal valore fondamentale dell'empatia.

Tailor Made in Italy

HANDCRAFTED FOR YOU

Whether it is in the design, the craftsmanship or the materials used, Impatia always draws upon the highest quality of Italian traditions and innovations to create something that is harmonized between classic and modern. Impatia collaborates with talented artisans from across the country to bring to light creations that are one-of-a-kind. Entirely Made in Italy. Proudly Made in Lombardy.

Nel design, nell'artigianato e nei materiali utilizzati, Impatia attinge sempre alla massima qualità della tradizione e innovazione italiana, perseguendo l'obiettivo di armonizzare classico e moderno. Impatia collabora con artigiani di talento da tutto il paese, proponendo creazioni uniche nel loro genere. Interamente Made in Italy. Orgogliosamente Made in Lombardia.

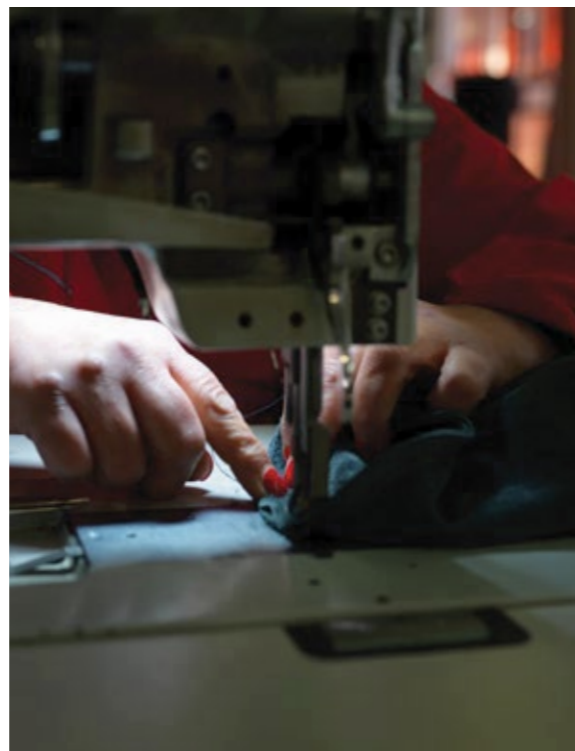

Artisan Workshop
Handcrafted leather pockets



Marble Workshop
The process of smoothing a block of marble to create Tocco



Game Tables

Filotto Collection

BILLIARD TABLE

Filotto is the first product created for Impatia's collection, that gives new life, new characteristics and new values to a classic product. The design, construction and workmanship of this work of genius are all Italian – showcasing the highest expression of technological sophistication and craftsmanship that has always distinguished Italy from the rest of the world.

Filotto è il primo tavolo ideato per la collezione di Impatia che dona nuova vita, nuove caratteristiche e nuovi valori a un prodotto classico. Il design, la costruzione e la lavorazione di questo innovativo biliardo sono tutti italiani e mostrano la massima espressione di sofisticazione tecnologica e dell'artigianalità che ha sempre distinto l'Italia dal resto del mondo.

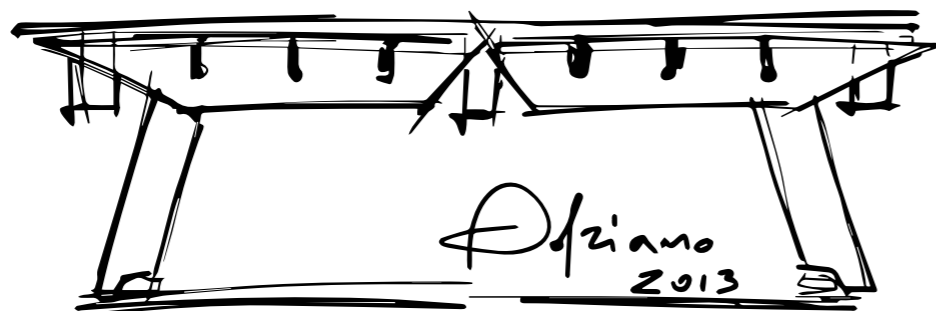

Filotto Classic
CHartreuse Simonis cloth and Nero leather pockets



Filotto Classic



Filotto Classic
Low-iron glass with metal components

Filotto Collection

Filotto Gold

This edition of the Filotto takes the world of luxury to a whole new level by featuring handcrafted connecting joints made from gold made by Italian goldsmiths. While indeed beautiful in many aspects, the Filotto Gold Edition likewise ensures a premium quality gaming experience.

Questa edizione del Filotto porta il mondo del lusso a un livello completamente nuovo, caratterizzato da giunti artigianali in oro realizzati da orafi italiani. Anche Filotto Gold garantisce un'esperienza di gioco di qualità premium.

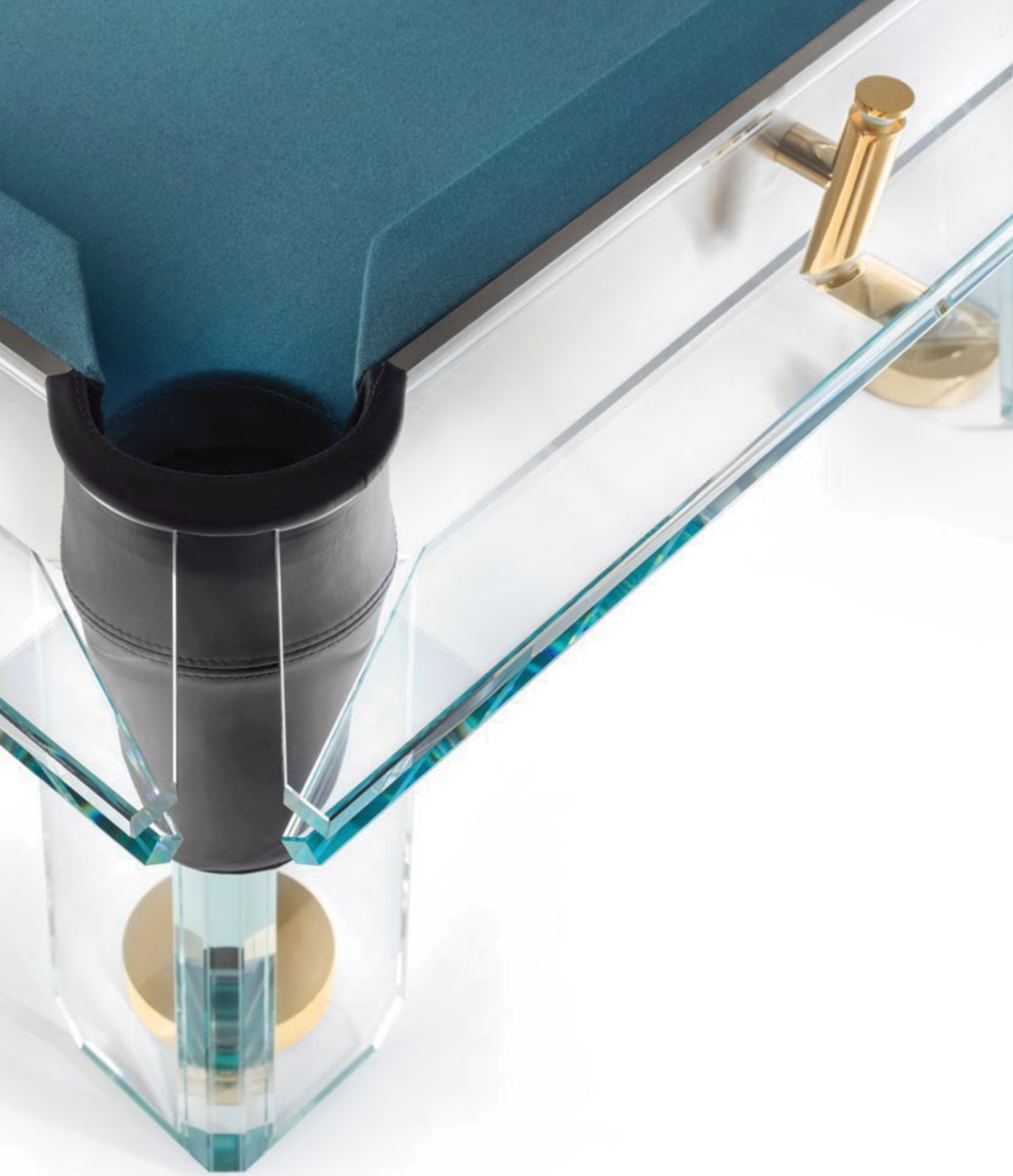



Filotto Gold
Powder Blue Simonis cloth and Nero leather pockets



Filotto Dark

As a staple among Impatia's luxury game table collection, the Filotto pool table has always left an unforgettable impression, and now even more so with its sleek and modern smoked glass finish.

As a professional pool table, available in 8ft and 7ft the Filotto Dark has a slate base, essential for any dedicated player, complemented by a customizable Simonis cloth playing field and elegant leather pockets.

Come un punto fermo nella collezione di tavoli da gioco di lusso di Impatia, il tavolo da biliardo Filotto ha sempre lasciato un'impressione indimenticabile, e ora ancora di più con la sua elegante e moderna finitura in vetro fumé.

Filotto Dark, tavolo da biliardo professionale, disponibile in 8 piedi e 7 piedi, ha una base in ardesia, essenziale per ogni giocatore dedicato, completata da un campo da gioco in tessuto Simonis personalizzabile ed eleganti buche in pelle.



Smoked glass frame with handcrafted leather pocket



Customizable Simonis cloth playing field





Filotto Wood
Bronze glass with walnut wood legs



Filotto Wood
Dark oak legs with a Slate Grey Simonis cloth and Nero leather pockets

Lungolinea Collection

TABLE TENNIS

The idea of playing on a transparent game table may seem unimaginable, but thanks to careful engineering, it is now possible. Even for the most competitive professional players, a game of table tennis can now be enjoyed on a table made of complete glass.

Giocare su una superficie trasparente può sembrare inimmaginabile, ma l'attenta progettazione di Lungolinea lo rende possibile. Con questo tavolo, anche i giocatori professionisti più competitivi possono apprezzare il tennis da tavolo su una superficie completamente in vetro.

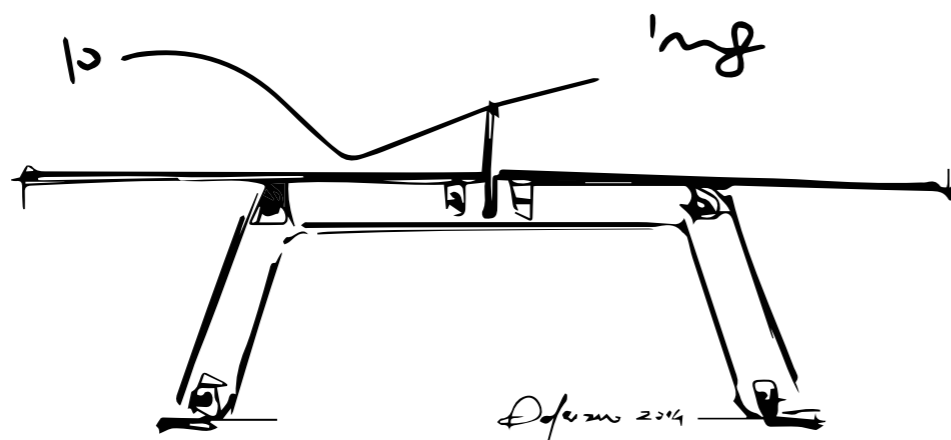

Lungolinea Classic
Ping pong game set



Lungolinea Classic



Lungolinea Classic
Low-iron glass with chrome components

Lungolinea Collection

Lungolinea Gold



Lungolinea Gold
Gold plated components

Lungolinea Wood



Lungolinea Wood
Walnut legs with chrome components



This edition of the Lungolinea incorporates detailing in wood adding a soft warm touch to the glass transparent exterior of the table.

Questa edizione di Lungolinea incorpora dettagli in legno che aggiungono un tocco morbido e caldo alla superficie in vetro trasparente del tavolo.



Lungolinea Wood
Walnut legs with chrome components



Lungolinea Leather

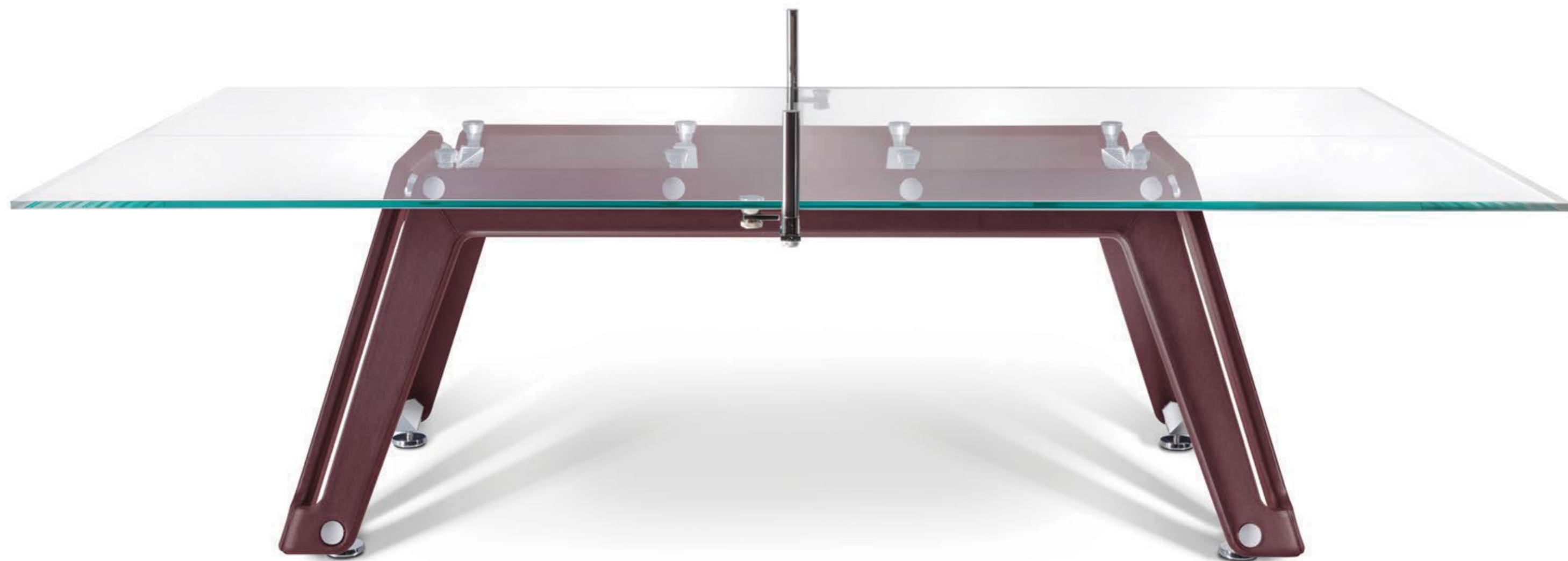

Lungolinea Leather
Low-iron glass with chrome components



Lungolinea Leather
Vino leather

Scivolo Collection

SHUFFLEBOARD TABLE

Scivolo represents IMPATIA's contemporary take on the traditional shuffleboard table, a game renowned for its ability to transcend barriers and unite people. Distinguished by its groundbreaking design featuring the innovative use of glass and minimalist aesthetics, Scivolo stands as a testament to original Italian design and masterful artisan production—a genuine Made in Italy masterpiece.

Scivolo rappresenta l'interpretazione contemporanea di IMPATIA del tradizionale Shuffleboard, un gioco noto per la sua capacità di superare le differenze e unire le persone. Distinguendosi per il suo design all'avanguardia che presenta l'uso innovativo del vetro e un'estetica minimalista, Scivolo diventa un testimone del design italiano originale e della produzione artigianale di eccellenza—un autentico capolavoro Made in Italy.



Scivolo Wood
Walnut frame with a low-iron glass legs



Scivolo Wood



Scivolo Wood
Walnut and low iron structure with chrome components



The Scivolo shuffleboard showcases a walnut wood frame, adding a warm and linear feel to the transparent glass legs and playing surface. Renowned for its timeless luxury finish, the Alcantara padding comes in a selection of 10 standard colors. Scivolo is thoughtfully designed to create an unparalleled gaming experience that seamlessly merges style with functionality.

Lo shuffleboard Scivolo mostra una cornice in legno di noce, che aggiunge un tocco caldo e lineare alle gambe trasparenti in vetro e alla superficie di gioco. Rinomato per la sua finitura di lusso senza tempo, il rivestimento in Alcantara è disponibile in una selezione di 10 colori standard. Scivolo è progettato con cura per creare un'esperienza di gioco senza pari, che fonde in modo impeccabile lo stile con la funzionalità.



Scivolo Wood
Alcantara and walnut surface

Derby Collection

FOOSBALL TABLE

For a game that is loved by many around the world, IMPATIA is proud to present the Derby Collection, a modern rendition of the classic football table elevated by refined design, innovation, and the highest level of Italian artistry.

Dedicato ad un gioco amato in tutto il mondo, IMPATIA è orgogliosa di presentare la collezione Derby, una moderna interpretazione del classico calcio balilla, impreziosito da un design raffinato, innovativo e dal più alto livello di arte italiana.





Derby Wood
Walnut frame with bronze glass playing field





Seamless Design

Handcrafted in Italy, Derby Wood unveils a crystal-clear glass playing field, supported by a contemporary solid wood structure finished with sublime metal detailing. Taking the game of foosball to new heights, Derby captures a beautiful balance between innovation and the long-applauded workmanship of Italian artisans.

Prodotto artigianalmente in Italia, Derby Wood è caratterizzato da un campo da gioco in vetro cristallino, sostenuto da una struttura contemporanea in legno massello rifinita con sublimi dettagli in metallo. Derby eleva il gioco del calcio balilla a nuove vette, raggiungendo un bellissimo equilibrio tra innovazione e la rinomata eccellenza dell'artigianato italiano.



Smooth shapes
The solid wood frame is embedded with sleek metal detailing



Geometric Handles
Solid wood handles connected to metal rods.





Derby Canvas



Derby Canvas
White lacquered solid wood and chrome components

Unotto Collection

CARD TABLE

Unotto is the reinterpretation of the traditional professional card table, making the A-game stylish and sophisticated. The entire structure is made of glass and is inspired by the classic cut of the diamond. The octagonal table consists of a frame that supports the playing surface in Alcantara®. The chrome finish metal legs make this jewel of an Italian design even more brilliant.

Unotto è la reinterpretazione del tradizionale tavolo da gioco di carte professionale, in grado di ridefinire l'A-game in modo elegante e sofisticato. L'intera struttura è in vetro ed è ispirata al classico taglio del diamante. Il tavolo ottagonale è costituito da una cornice che sostiene la superficie di gioco in Alcantara®. Le gambe in metallo con finitura cromata rendono questo gioiello del design italiano ancora più brillante.

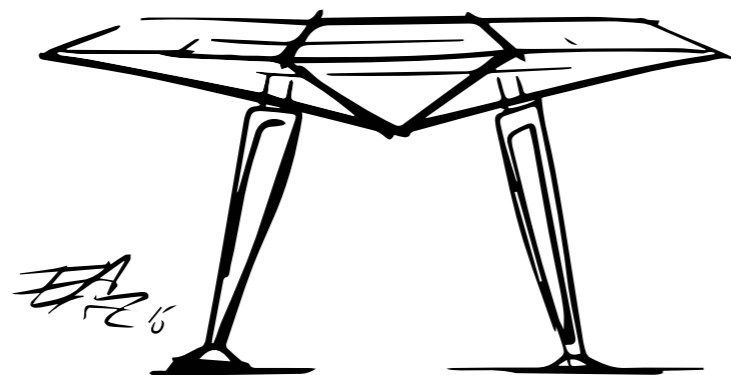

Unotto Marble
Nero Marquina marble frame with a low-iron glass edge





Unotto Marble
Nero Marquina marble frame with a Pearl Alcantara playing surface

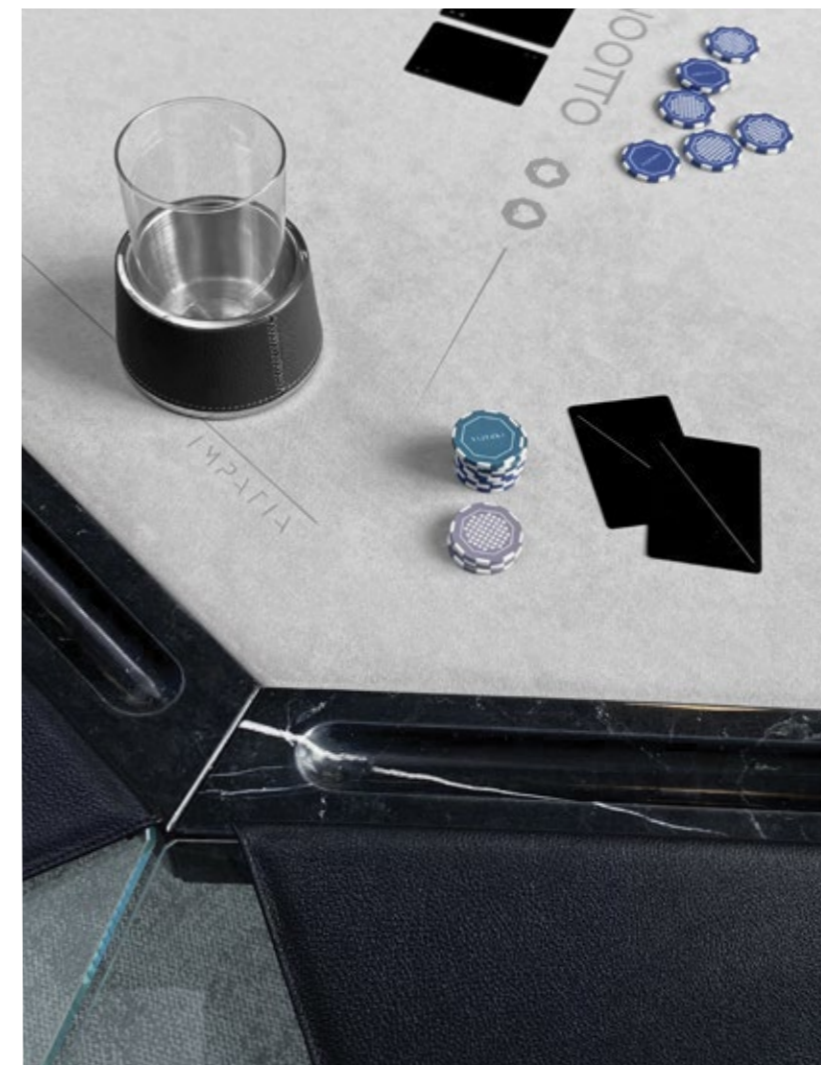

Unotto Marble
Italian marble available in three colours



Unotto Marble

DARK EDITION

The refined lines of the Unotto card table welcome the player into the zone, that magic area in which the individual becomes one with the table, plunging into the game to the point of being able to predict his opponents' moves and transform his own to elicit success.

Le linee raffinate del tavolo da gioco di carte Unotto accolgono il giocatore in quell'area magica in cui l'individuo diventa un tutt'uno con la superficie di gioco, immergendosi nella partita fino a poter predire le mosse dei suoi avversari, o trasformare le proprie per vincere.

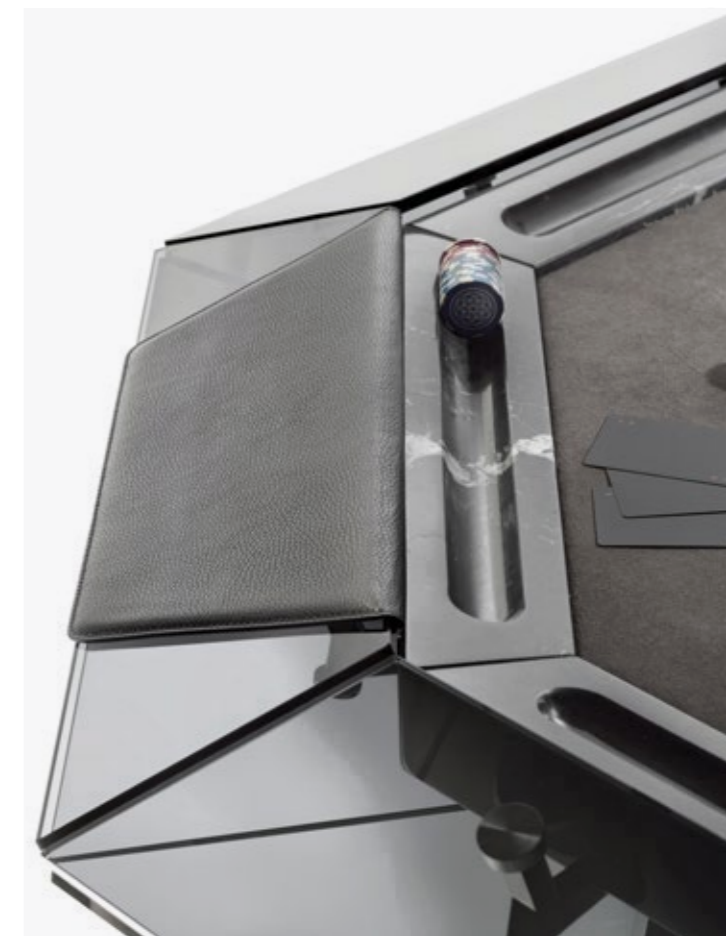

Unotto Dark
Smoked glass with black matte components



Unotto Wood
8 players card table with Bronze glass top and Walnut wood frame

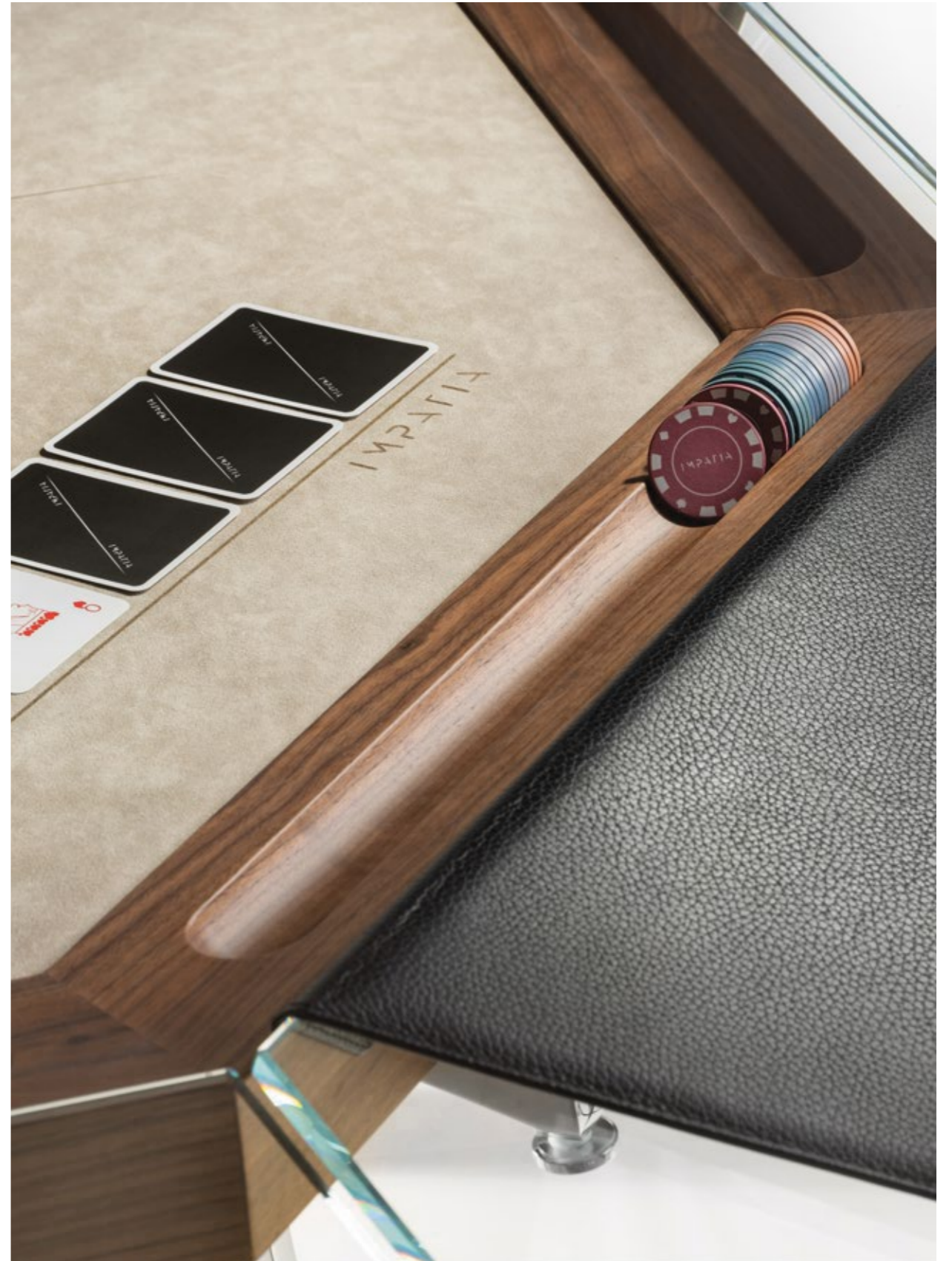

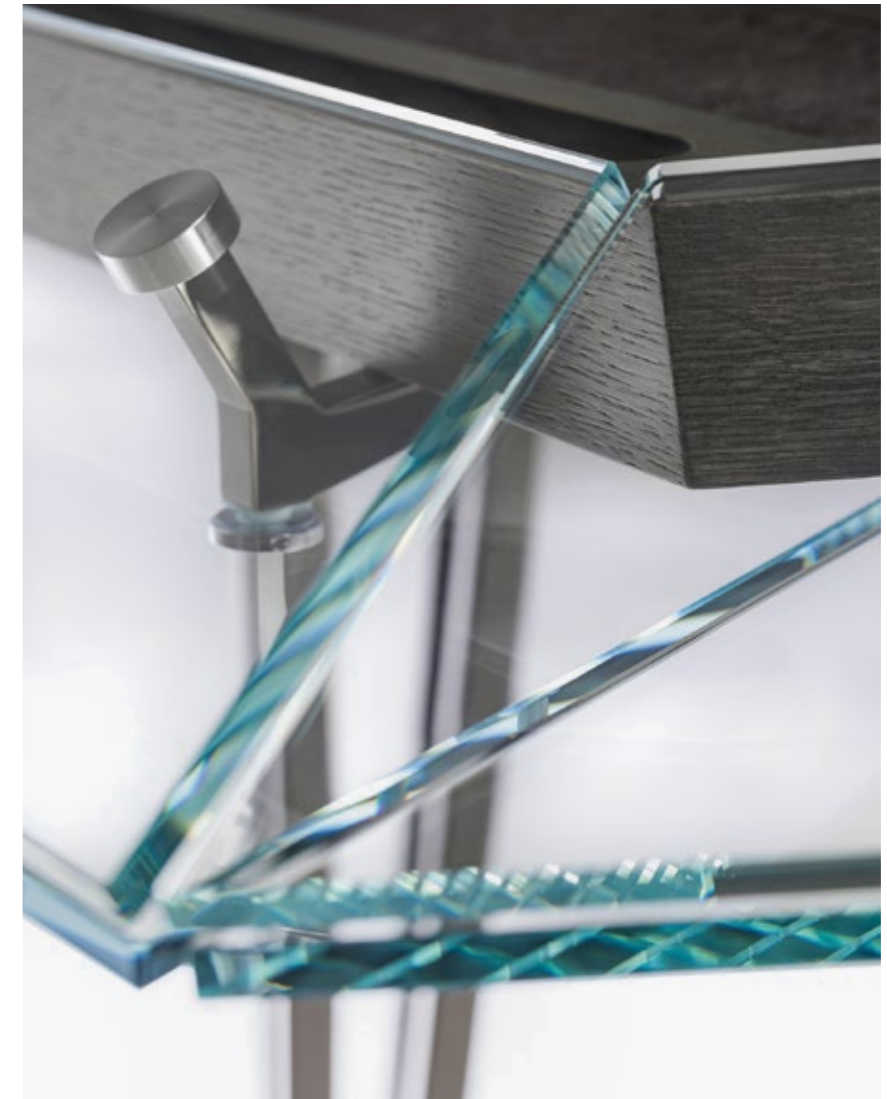

Unotto Wood
Transparent glass with Dark oak and Anthracite Alcantara

Tuttuno Collection

MULTI-GAME TABLE

This modern table is designed to accommodate two or four players. The minimalistic design gives off the unique impression that the table is floating. Its design incorporates complexity and high quality material selection. The table is available in the Mahjong, Backgammon or Checkers Edition, which includes exclusive game box sets developed by Impatia.

Questo moderno tavolo è progettato per ospitare due o quattro giocatori. Il design minimalista dà l'impressione unica che il tavolo fluttui nello spazio. Il suo design incorpora complessità e selezione dei materiali di alta qualità. Il tavolo è disponibile nelle edizioni Mahjong, Backgammon o Dama, che includono esclusivi cofanetti di gioco disegnati da Impatia.

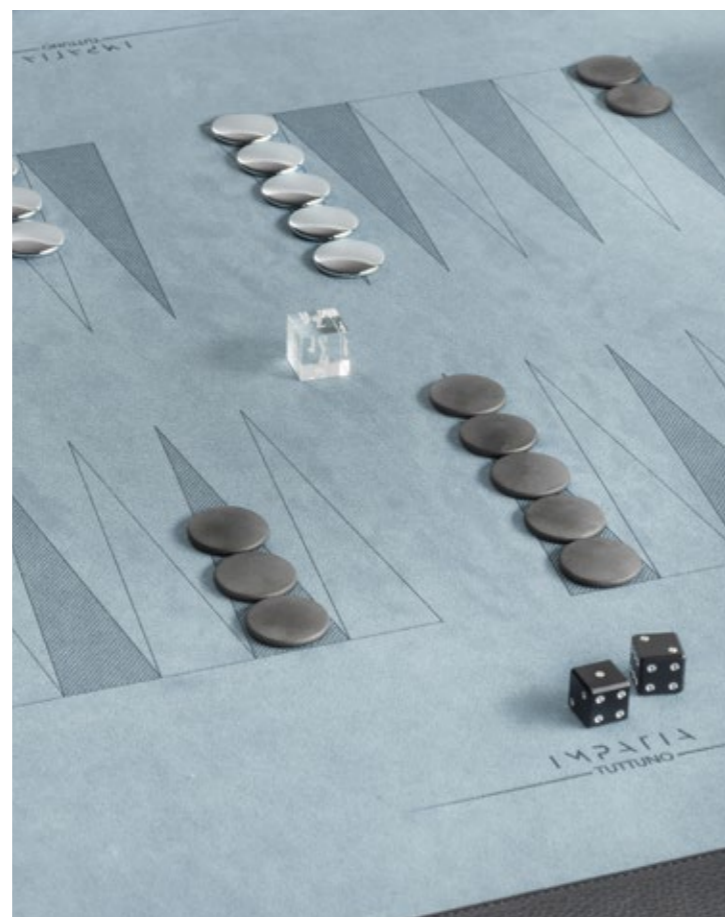

Tuttuno Leather
Sky Alcantara with a Backgammon playing surface



Tuttuno Leather
BACKGAMMON

Tuttuno Leather
CHECKERS



Tuttuno Leather
Sea Sand Alcantara checkers playing surface with Tobacco leather armrests





Tuttuno Leather MAHJONG

Tuttuno's transparent aesthetic is the result of design precision and materiality. The elegant Alcantara® covering of the playing surface is highlighted by the essential glass structure of Tuttuno, which, with a simple gesture, can also be used as an elegant side table.

L'estetica trasparente di Tuttuno è il risultato della precisione e della materialità del design. L'elegante rivestimento in Alcantara® della superficie di gioco è evidenziato dall'essenziale struttura in vetro di Tuttuno che, con un semplice gesto, può essere utilizzato anche come elegante tavolino.



Tuttuno Mahjong
Custom designed Mahjong tiles



Games and Accessories

Lancio Marble

CORNHOLE

IMPATIA reimagines the classic game of "cornhole" by blending sophisticated design with the game's inherent simplicity. Suitable for both indoor and outdoor settings, Lancio's unique design features a glass plate supported by a marble base, available in multiple finishes. Lancio is complemented with eight cornhole bags meticulously handcrafted by Italian artisans using Alcantara.

IMPATIA reinterpreta il classico gioco del "cornhole" unendo un design sofisticato alla semplicità intrinseca del gioco. Adatto sia per ambienti interni che esterni, il design unico di Lancio presenta un piatto in vetro supportato da una base in marmo, disponibile in molteplici finiture. Lancio è arricchito da otto sacchetti per cornhole meticolosamente realizzati a mano da artigiani italiani utilizzando l'Alcantara.



Lancio Marble
Alcantara bags

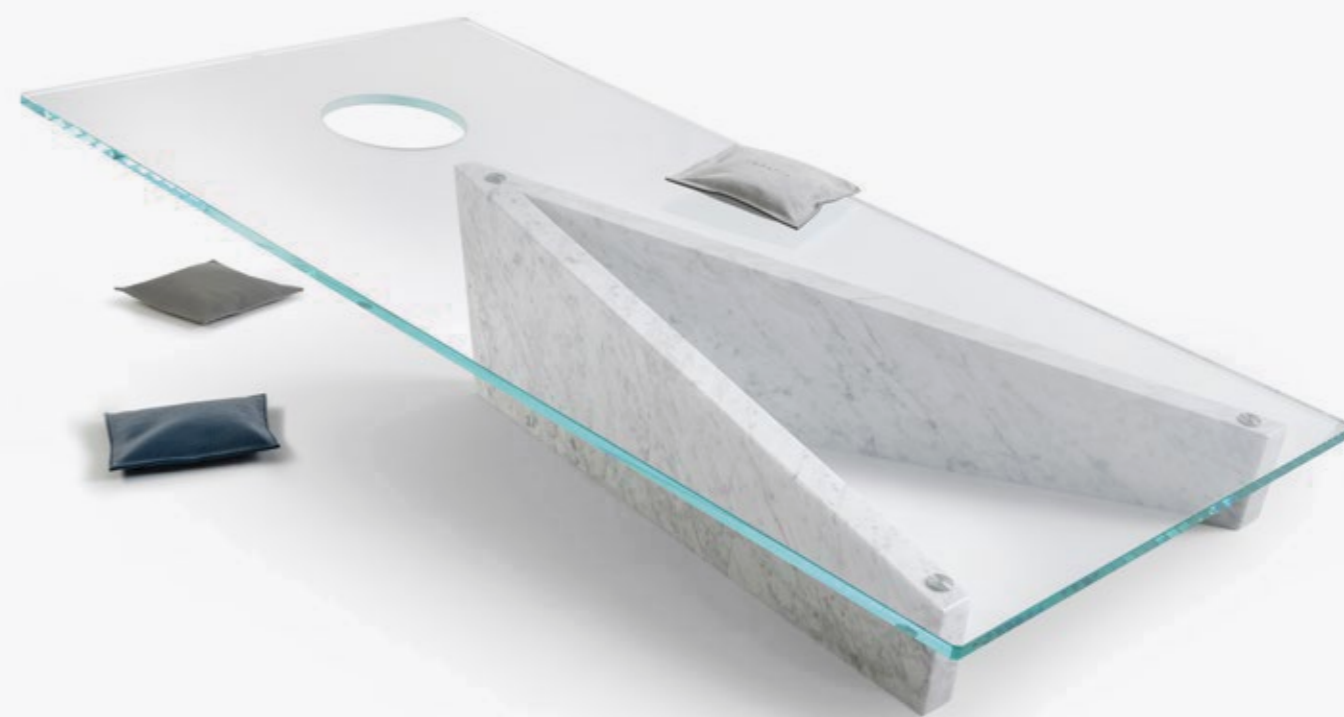

Tocco
MARBLE CUE RACK

Italian marble in its truest form, showcased with subtle touches of minimalistic design to enhance any living space. The Tocco cue rack is a classic accessory that has been reinterpreted in a flawless manner.

Il marmo italiano nella sua forma più vera, dal design minimalista in grado di valorizzare qualsiasi spazio abitativo. Il porta stecche Tocco è un accessorio classico che è stato reinterpretato in modo impeccabile.



Tocco by Adriano Design
Bianco di Carrara



Verso

CUE RACK

The Verso glass cue rack distinguishes itself as a singular example of design and functionality, reinventing a classic accessory with visual boldness and timeless elegance. The cues, placed at the sides of the structure, highlight the perfect equilibrium between form and function, where every detail is conceived to elevate the game to new achievements.

Il porta stecche Verso si distingue come un esemplare unico di design e funzionalità, reinventando un accessorio classico con un'audacia visiva e una raffinatezza senza tempo. Le stecche, poggiate ai lati della struttura, sottolineano l'equilibrio perfetto tra forma e funzione, dove ogni dettaglio è pensato per elevare il gioco a nuovi traguardi.



Verso by IMPATIA R&D
Low-iron glass



Filotto Game Set

BILLIARDS

Among a strong focus on developing one of kind game tables it is just as equally important to focus on the accessories. As a result, Impatia offers a range of luxury game accessories that complement each table perfectly. Extending the use of high-quality materials and Italian craftsmanship each accessory set is carefully thought out and designed to perfection.



Billiards Game Set
Handcrafted from leather

Unootto Game Set

POKER

Oltre ad una forte attenzione allo sviluppo di tavoli da gioco unici nel loro genere, è altrettanto importante concentrarsi sugli accessori. Di conseguenza, Impatia offre una gamma di accessori di gioco di lusso che completano perfettamente ogni tavolo. Estendendo l'uso di materiali di alta qualità e artigianato italiano, ogni set di accessori è attentamente pensato e progettato alla perfezione.



Poker Game Set
Handcrafted from leather

Tuttuno Game Set
BACKGAMMON



Backgammon Game Set
Handcrafted from leather

Tuttuno Game Set
MAHJONG



Mahjong Game Set
Handcrafted from leather

Tuttuno Game Set
CHECKERS



Checkers Game Set
Handcrafted from leather with metal detailing.



Precious Leather Collection

Precious Leather Game Sets

This new collection of accessories, presented and designed by the IMPATIA R&D team, seeks to highlight a balance between vivid colors and the natural textures combined in this luxurious type of leather. The Minimalist and timeless design is juxtaposed with the traditions of master leatherworkers through chromed metal elements, which create a play of light and reflections in contrast to the natural materials.

Questa nuova collezione di accessori, presentata e progettata da IMPATIA R&D, ricerca un equilibrio tra la brillantezza dei colori e l'intensità delle texture naturali delle pelli, finemente accostate tra loro. Il design minimalista e senza tempo si affianca alla tradizione dei mastri pellettieri attraverso gli elementi metallici cromati, creando un gioco di luci e riflessi con i materiali naturali.



Billiards Game Set
Crocodile box with glass and metal detailing.



Poker Game Set
Crocodile box with glass and metal detailing.

Checkers Game Set
Crocodile box with metal detailing.



Backgammon Game Set
Crocodile box with metal checkers.



Mahjong Game Set
Crocodile box with engraved metal tiles.



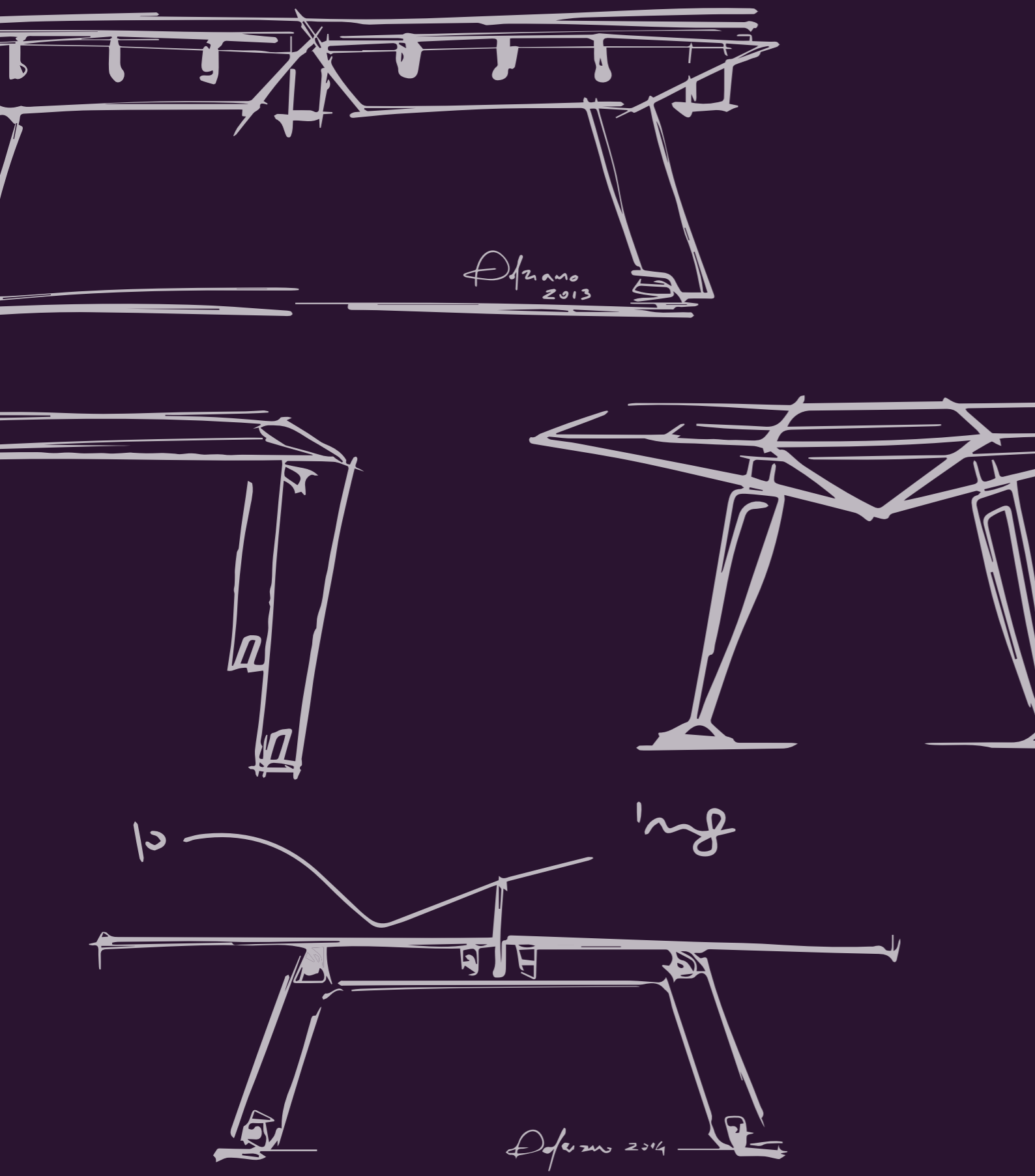

IMPATIA and the Creative Team

A human-to-human approach

At Impatia each creation is a tale of excellence, driven by the core value of empathy. The human-to-human approach creates a journey of exploration, which is highlighted by technical development, high-quality materials, and incomparable aesthetic refinement.

In Impatia ogni creazione è un racconto di eccellenza, guidato dal valore fondamentale dell'empatia. L'approccio uomo-a-uomo pone le basi ad un viaggio di esplorazione per ogni creazione, evidenziato dallo sviluppo tecnico, dai materiali di alta qualità e dall'incomparabile raffinatezza estetica.



Creative Direction

IMPATIA

Founders Irene Prandoni and Gregg Brodarick lead the creative process at Impatia, developing design products that showcase beautiful aesthetics along with functionality. Both with a background in architecture, the Italian and American duo bring a unique tailor-made experience that constantly aims to push the boundaries of the game table industry and bring a flair to the DNA of Impatia.

I fondatori Irene Prandoni e Gregg Brodarick guidano il processo creativo di Impatia, sviluppando prodotti di design che uniscono elementi dell'estetica più elegante alla funzionalità. Accomunato anche dalla formazione nel campo dell'architettura, il duo italo-americano condivide un'esperienza unica e su misura che mira costantemente a ridefinire i confini dell'industria dei tavoli da gioco, incorporandoli nel DNA di Impatia.



Lucia Guazzi

PRODUCT DESIGNER

Product Designer Lucia Guazzi, who graduated from Politecnico Milano, is part of Impatia's research and development team, helping develop a range of design products within the collection. In 2022, Guazzi received multiple awards for the Derby Football Table, including the GOOD DESIGN and the Archiproduct Design Award. With a balance between technical knowledge and creative ability, Guazzi elevates Impatia's R&D team into creating design objects that showcase a beautiful way to have fun.

La Product Designer Lucia Guazzi, laureata al Politecnico di Milano, fa parte del team di ricerca e sviluppo di Impatia, contribuendo allo sviluppo di una gamma di prodotti di design all'interno della collezione. Nel 2022, Guazzi ha ricevuto numerosi premi per il Calcio balilla Derby, inclusi il GOOD DESIGN e l' Archiproduct Design Award. Con un equilibrio tra conoscenza tecnica e capacità creativa, Guazzi porta il team di R&S di Impatia a creare oggetti di design che mostrano un modo bello di divertirsi.



Adriano Design

PRODUCT DESIGNERS

The Torino based design studio Adriano Design, formed by brothers Davide and Gabriele Adriano, designed the glass Lungolinea table tennis and Filotto billiard table for Impatia. Established in 1997, the studio has worked in collaboration with prominent global brands. Their wide range of work has also been displayed in some of the most distinguished museums, including the Triennale Design Museum in Milan and the Chicago Athenaeum. They have received numerous international awards, including the prestigious Compasso d'Oro ADI in 2014 and 2022.

Lo studio di design torinese Adriano Design, fondato dai fratelli Davide e Gabriele Adriano, ha creato per Impatia il tavolo da ping pong in cristallo Lungolinea e il tavolo da biliardo Filotto. Avviato nel 1997, lo studio vanta collaborazioni con rinomati marchi internazionali. Una selezione dei loro numerosi progetti è stata esposta in prestigiosi musei, tra cui la Triennale di Milano e il Chicago Athenaeum. Hanno ottenuto diversi riconoscimenti internazionali, inclusi il Compasso d'Oro nel 2014 e nel 2022.



Enrico Azzimonti

ARCHITECT AND DESIGNER



Enrico Azzimonti designed the Unootto glass poker table for Impatia which received the distinguished GOOD DESIGN Award in 2022. Driven by a passion for innovation and Italian industrial design, Azzimonti established his studio in 1994 and since then has researched and developed products for Italian and international brands.

He has won numerous awards, including the Platinum A'Design Award in 2017, and selections of his projects are permanently shown in The Design Museum of Barcelona.

Enrico Azzimonti ha progettato il tavolo da poker in vetro Unootto per Impatia, ricevendo il prestigioso premio GOOD DESIGN nel 2022. Mosso da una passione per l'innovazione e il design industriale italiano, Azzimonti ha fondato il suo studio nel 1994 e da allora si è dedicato alla ricerca e allo sviluppo di prodotti per marchi italiani e internazionali.

Ha ricevuto numerosi riconoscimenti, tra cui il Platinum A'Design Award nel 2017, e alcune selezioni dei suoi progetti sono esposte in modo permanente al Museo del Design di Barcellona.



Technical Information

Filotto Classic
8ft Pro*



268 cm

105.5"

82 cm (h)
32"



152 cm

60"

PRODUCT INFORMATION

Frame and legs in low-iron glass
Chrome components
Three-piece Italian slate base
Simonis cloth
Leather pockets
**Also available in 7ft*

PRODUCT WEIGHT

640 Kg / 1410 lbs

PACKAGING INFORMATION

165 x 134 x 76 cm (h)
65" x 52" x 30" (h)
780 Kg / 1719 lbs

SELECTED GLASS



Transparent

SELECTED METAL



Chrome

SUGGESTED ROOM DIMENSION

600 cm x 485 cm / 234" x 190"

MINIMUM ROOM DIMENSION

550 cm x 435 cm / 217" x 171"

Filotto Dark
8ft Pro*



268 cm

105.5"

82 cm (h)
32"



152 cm

60"

PRODUCT INFORMATION

Frame and legs in tinted glass
Chrome components
Three-piece Italian slate base
Simonis cloth
Leather pockets
**Also available in 7ft*

SELECTED GLASS



Smoked



Bronze

SELECTED METAL



Chrome

PRODUCT WEIGHT

640 Kg / 1410 lbs

PACKAGING INFORMATION

165 x 134 x 76 cm (h)
65" x 52" x 30" (h)
780 Kg / 1719 lbs



Simonis cloth



Frame and legs in low-iron glass



Leather pockets



Chrome foot joint



Bronze glass frame



Leather pocket

Designed by Adriano Design

Filotto Gold
8ft Pro*



268 cm

105,5"

82 cm (h)
32"



152 cm

60"

PRODUCT INFORMATION

Frame and legs in low-iron glass
Selected gold plated components
Three-piece Italian slate base
Simonis cloth
Leather pockets
**Also available in 7ft*

PRODUCT WEIGHT

640 Kg / 1410 lbs

PACKAGING INFORMATION

165 x 134 x 76 cm (h)
65" x 52" x 30" (h)
780 Kg / 1719 lbs

SELECTED GLASS



Transparent

SELECTED METAL



Gold plated

SUGGESTED ROOM DIMENSION

600 cm x 485 cm / 234" x 190"

MINIMUM ROOM DIMENSION

550 cm x 435 cm / 217" x 171"



Gold plated components



Frame and legs in low-iron glass

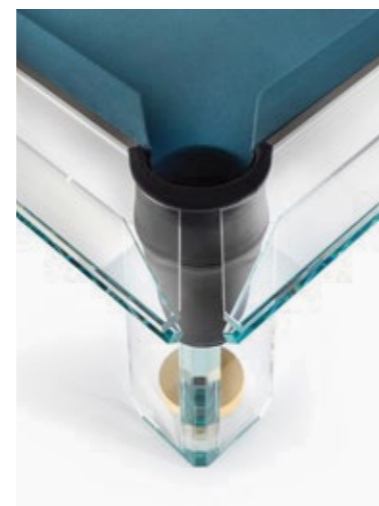

Leather pockets

Filotto Wood
8ft Pro*



268 cm

105,5"

82 cm (h)
32"



152 cm

60"

PRODUCT INFORMATION

Frame in tinted glass
Legs in wood
Chrome components
Three piece Italian slate base
Simonis cloth
Leather pockets
**Also available in 7ft*

SELECTED GLASS



Transparent



Smoked



Bronze

SELECTED METAL



Chrome

SELECTED WOOD



Natural Oak



Walnut



Dark Oak



Natural Oak Legs



Bronze glass frame
Walnut wood legs



Smoked glass frame

Designed by Adriano Design

Filotto Collection
7ft



82 cm (h)
32"



PRODUCT INFORMATION
Frame and legs in low-iron glass
Chrome components
Two-piece Italian slate base
Simonis cloth
Leather pockets

SUGGESTED ROOM DIMENSION
555 cm x 455 cm / 219" x 179"

MINIMUM ROOM DIMENSION
with standard cue sticks
500 cm x 400 cm / 197" x 175"

PRODUCT WEIGHT
445 Kg / 981 lbs

PACKAGING INFORMATION
CASE 1
217 x 116 x 25 cm (h)
86 x 46 x 10"
315 kg / 695 lbs

CASE 2
165 x 134 x 60 cm (h)
65 x 53 x 24"
420 kg / 926 lbs

7FT VERSION IS AVAILABLE IN:
Classic
Gold
Dark
Wood

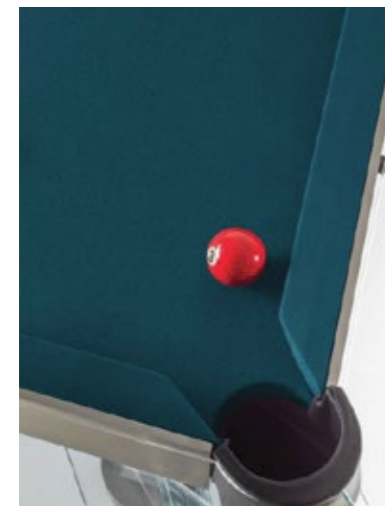

Simonis cloth



Frame and legs in low-iron glass



Leather pockets

Designed by Adriano Design

Filotto Simonis Cloth



Selected Leathers



Filotto Accessories

**Billiards Game Set**

Design by IMPATIA R&D
Handcrafted from leather with glass detailing and chrome components
Available in a range of 10 colors.
Made in Italy

SET INCLUDES

1 Professional cue ball game set
1 Leather triangle rack

DIMENSIONS AND WEIGHT

36,3 Ø x 8,5 cm
14,3" Ø x 3,3"
Gross Weight: 5kg / 11 lbs

**Tocco Cue Rack**

Design by Adriano Design
Solid marble. Made in Italy
*Cue stick set not included

DIMENSIONS AND WEIGHT

28 x 28 x 28 (h) cm
11" x 11" x 11" (h)
36 Kg / 79 lbs

PACKAGING INFORMATION

35 x 35 x 40 (h) cm
14" x 14" x 16" (h)
40 Kg / 88 lbs

Cue Stick Set (4)

Longoni x Impatia
Made in Italy

**Filotto Removable Top**

FENIX custom top
Consists of two-pieces
Made in Italy
Includes removable ping pong net kit.

DIMENSIONS AND WEIGHT

137cm x 152.5cm x 1cm each piece
54" x 60" x 0.4" each piece
76 kg / 168 lbs

PACKAGING INFORMATION

161 x 145 x 37 cm (h)
64" x 57" x 15" (h)
160 Kg / 353 lbs

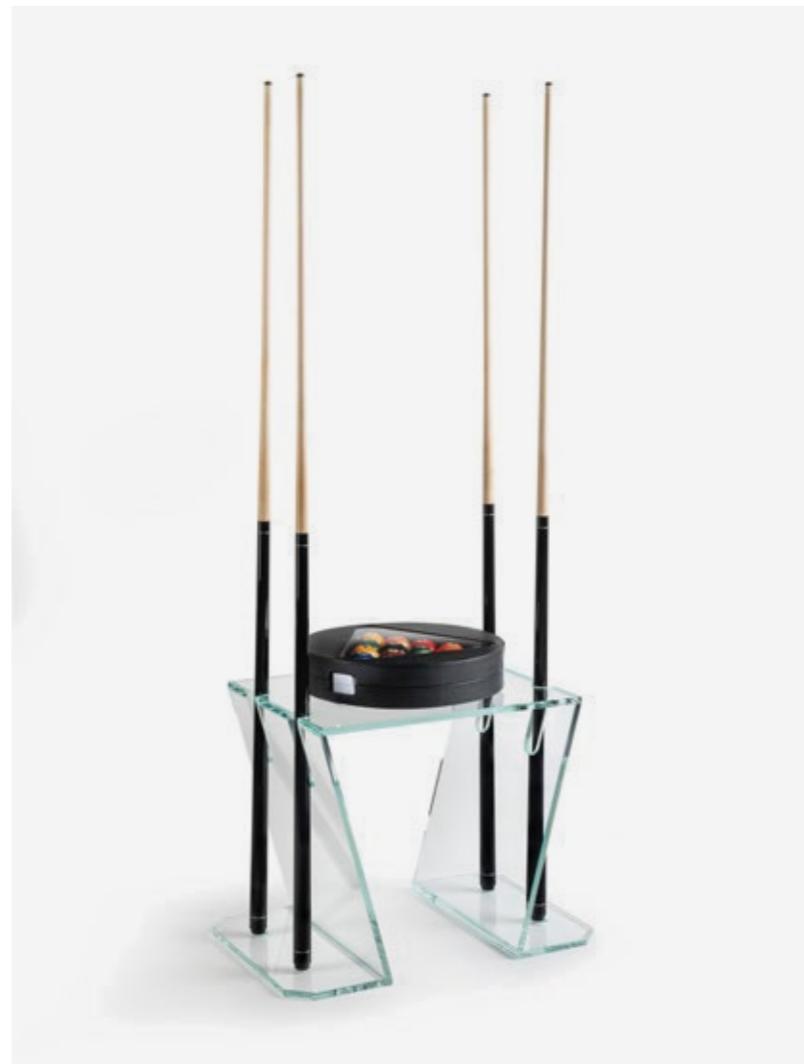
**Verso Cue Rack**

Design by IMPATIA R&D
Low-iron glass. Made in Italy

DIMENSIONS AND WEIGHT

60 x 40 x 45 (h) cm
24" x 16" x 18" (h)
20 Kg / 44 lbs

PACKAGING INFORMATION

72 x 52 x 60 (h) cm
28" x 20" x 24" (h)
40 Kg / 88 lbs

Lungolinea Classic



MATERIALS
 Low-iron glass
 Polished metal components
 Chrome connecting joints
 Alcantara® net

PRODUCT WEIGHT
 220 Kg / 485 lbs

PACKAGING INFORMATION
 204 cm x 151 cm x 40 cm (h)
 80" x 59" x 16" (h)
 340 kg / 750 lbs

SELECTED METAL

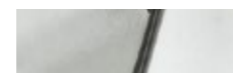

Chrome

ACCESSORIES
 1 Table tennis net kit
 2 Professional rackets
 4 Professional balls



Chrome metal components



Removable Alcantara net

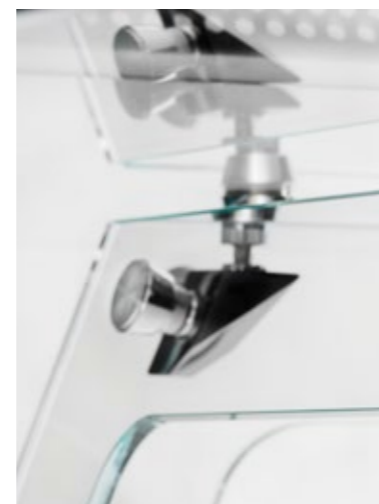

Metal components

Lungolinea Gold



MATERIALS
 Low-iron glass
 Polished metal components
 Selected gold plated connecting joints
 Alcantara® net

PRODUCT WEIGHT
 220 kg / 485 lbs

PACKAGING INFORMATION
 204 cm x 151 cm x 40 cm (h)
 80" x 59" x 16" (h)
 340 kg / 750 lbs

SELECTED METAL



Gold plated

ACCESSORIES
 1 Table tennis net kit
 2 Professional rackets
 4 Professional balls



Gold plated connecting joint

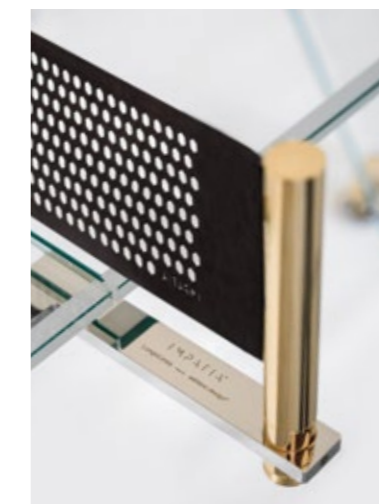

Removable Alcantara net



Gold plated connecting joint

Designed by Adriano Design

Lungolinea Wood

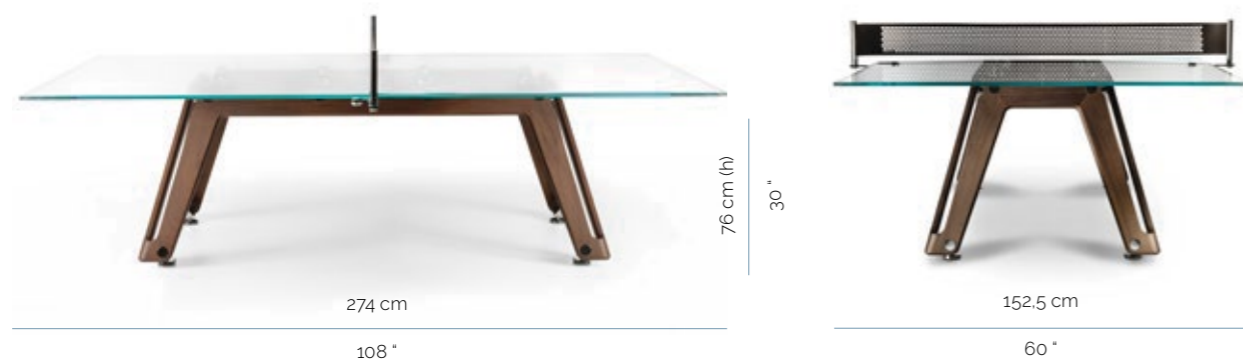

MATERIALS
 Top in Low-iron glass
 Base in wood
 Polished metal components
 Chrome connecting joints
 Alcantara net ®

ACCESSORIES
 1 Table tennis net kit
 2 Professional rackets
 4 Professional balls

PRODUCT WEIGHT
 200 kg / 441 lbs

PACKAGING INFORMATION
 204 cm x 151 cm x 40 cm (h)
 80" x 59" x 16" (h)
 320 kg / 705 lbs

SELECTED METAL



Chrome

SELECTED WOOD



Natural Oak



Walnut



Dark Oak



Chrome metal components



Removable Alcantara net



Wood base

Designed by Adriano Design

Lungolinea Leather



MATERIALS
 Low-iron glass table top
 Leather table base, options p. 116
 Chrome metal components
 Alcantara® net

ACCESSORIES
 1 Table tennis net kit
 2 Professional rackets
 4 Professional balls

PRODUCT WEIGHT
 200 Kg / 441 lbs

PACKAGING INFORMATION
 204 cm x 151 cm x 40 cm (h)
 80" x 59" x 16" (h)
 320 kg / 705 lbs

SELECTED METAL



Chrome

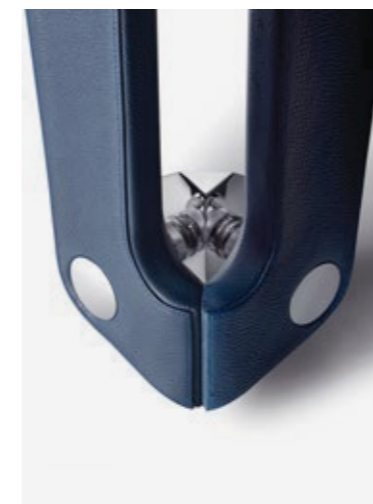

Chrome metal components



Removable Alcantara net

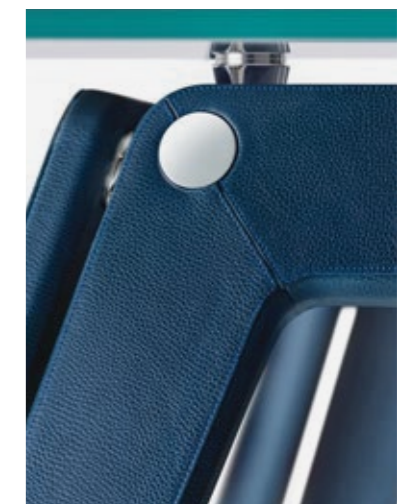

Navy leather base

Designed by Adriano Design

Scivolo Wood
12ft Shuffleboard



MATERIALS
Top in Low-iron glass
Base in wood
Metal components
Alcantara® surface

ACCESSORIES
8 Pucks
Shuffleboard Powder and Brush

PRODUCT WEIGHT
205 kg / 452 lbs

PACKAGING INFORMATION
CRATE 1
145 cm x 92 cm x 75 cm (h)
80" x 59" x 16" (h)
195 kg / 430 lbs

CRATE 2
330 x 55 x 30 cm (h)
130" x 22" x 12" (h)
190kg / 419 lbs

SELECTED METAL



Chrome

SELECTED WOOD



Walnut

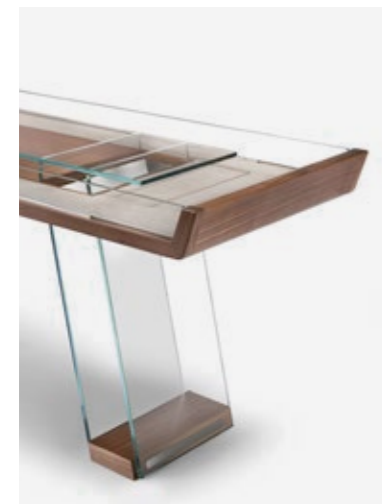

Low-iron leg



Removable Alcantara net

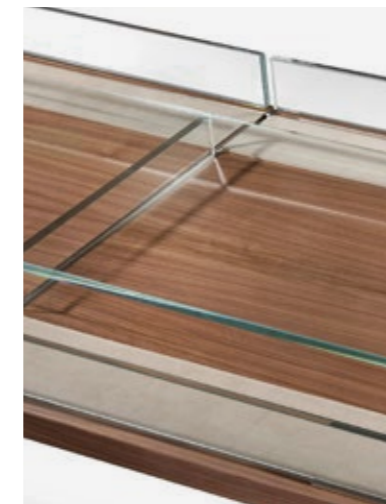

Wood base

Designed by IMPATIA R&D

Lancio Marble



MATERIALS
Low-iron glass frame
Marble structure
Alcantara® game set

PRODUCT WEIGHT
46kg / 101 lbs

PACKAGING INFORMATION
130 x 70 x 47 (h) cm
51" x 28" x 19" (h)

SELECTED GLASS



Transparent

SELECTED MARBLE



Bianco di Carrara



Bardiglio Nuvolato



Nero Marquina



Low-iron glass

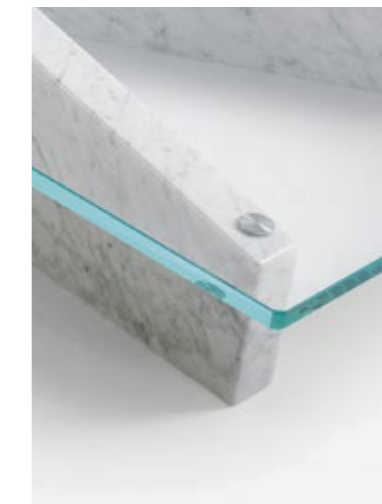

Marble Structure



Alcantara® Game set

Designed by IMPATIA R&D

Derby Wood

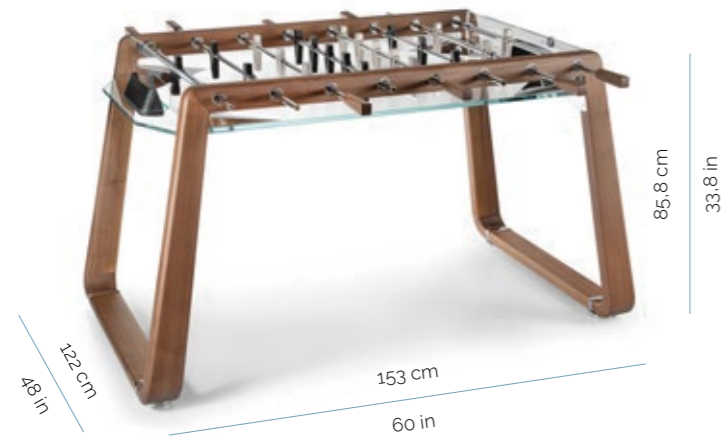



MATERIALS
 Wood structure
 Low-iron glass playing field
 Chrome finished metal components
 Anodised aluminum players
 Leather goal p. 103

PRODUCT WEIGHT
 80kg / 176 lbs

PACKAGING INFORMATION
 162cm x 94cm x 61(h)
 64" x 37" x 24" (h)
 160kg / 353 Lbs

SELECTED GLASS

 Transparent

SELECTED WOOD

 Natural Oak

 Walnut

 Dark Oak



Leather goal



Natural Oak and chrome details



Walnut and chrome details



Derby Dark





MATERIALS
 Wood structure
 Tinted glass playing field
 Chrome finished metal components
 Anodised aluminum players
 Leather goal p. 103

PRODUCT WEIGHT
 80kg / 176 lbs

PACKAGING INFORMATION
 162cm x 94cm x 61(h)
 64" x 37" x 24" (h)
 160kg / 353 Lbs

SELECTED GLASS

 Smoked

 Bronze

SELECTED WOOD

 Natural Oak

 Walnut

 Dark Oak

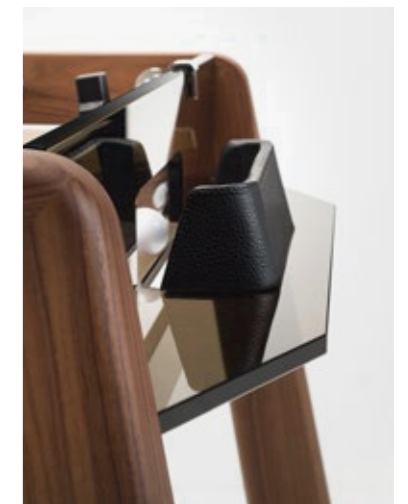

Dark Oak and smoked glass



Dark Oak legs



Walnut with bronze glass

Designed by IMPATIA R&D

Derby Canvas



MATERIALS
 Solid lacquered wood p.103
 Glass playing field
 Chrome finished metal components
 Anodised aluminum players

PRODUCT WEIGHT
 80kg / 176 lbs

PACKAGING INFORMATION
 162cm x 94cm x 61(h)
 64" x 37" x 24" (h)
 160kg / 353 Lbs



Transparent glass playing field



Chrome components



Leather Goal

Designed by IMPATIA R&D

Selected Glass

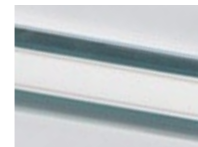

Transparent



Smoked

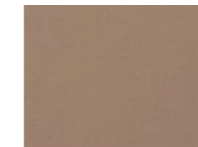

Bronze

Lacquered wood Selected Colors



White RAL



Traffic Grey RAL



Stone Grey RAL

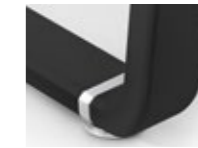

Black RAL



Orange Brown RAL

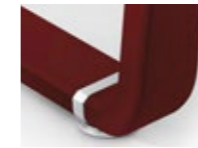

Wine Red RAL



Sapphire Blue RAL

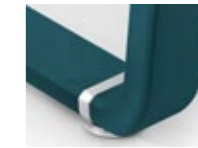

Ocean Blue RAL

Derby Selected Leathers

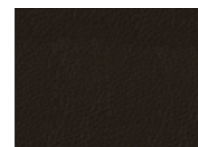

Nero

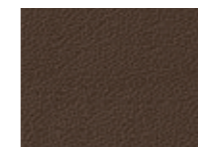

Tobacco

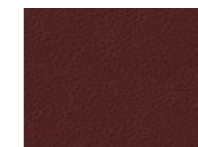

Vino

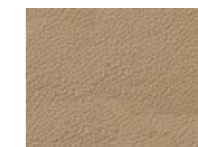

Beige



Viola

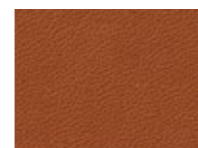

Arancio



Prato

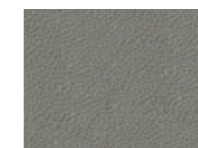

Gray

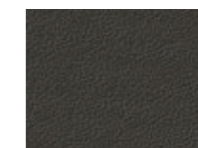

Ash



Navy

Unotto Marble

Also available in 10 Players



MATERIALS
 Low-iron glass frame
 Chrome finished legs and components
 Marble top structure
 Alcantara® playing surface

PRODUCT WEIGHT
 110 Kg / 242.5 lbs

PACKAGING INFORMATION
 142 cm x 142 cm x 40 cm (h)
 60" x 60" x 16" (h)
 205 kg / 452 lbs

SELECTED GLASS

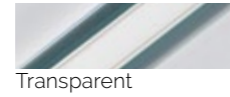

SELECTED METAL



SELECTED MARBLE



Chrome finished metal leg



Marble frame



Low-iron glass frame

Unotto Marble - Dark Edition

Also available in 10 Players



MATERIALS
 Smoked glass frame
 Selected black matte finished metal legs
 Marble top frame
 Alcantara® playing surface

PRODUCT WEIGHT
 110 Kg / 242.5 lbs

PACKAGING INFORMATION
 142 cm x 142 cm x 40 cm (h)
 60" x 60" x 16" (h)
 205 kg / 452 lbs

SELECTED GLASS

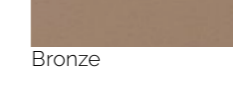
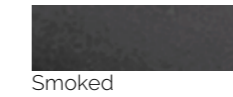

SELECTED MARBLE



Black matte metal finished leg



Nero Marquina marble frame



Smoked glass frame

Designed by Enrico Azzimonti

Unotto Wood

Also available in 10 Players



MATERIALS
 Low-iron glass frame
 Wood top frame
 Chrome finished legs and components
 Alcantara® playing surface



PRODUCT WEIGHT
 95 kg / 209 lbs

PACKAGING INFORMATION
 142 cm x 142 cm x 40 cm (h)
 60" x 60" x 16" (h)
 205 kg / 452 lbs

SELECTED GLASS

 Transparent

SELECTED METAL

 Chrome

SELECTED WOOD

 Natural Oak

 Walnut

 Dark Oak



Chrome finished metal leg



Walnut top frame



Dark oak top frame

Unotto Wood - Dark Edition

Also available in 10 Players



MATERIALS
 Glass frame
 Selected black matte finished metal legs
 Wood top frame
 Alcantara® playing surface

PRODUCT WEIGHT
 110 Kg / 242.5 lbs

PACKAGING INFORMATION
 142 cm x 142 cm x 40 cm (h)
 60" x 60" x 16" (h)
 205 kg / 452 lbs



SELECTED GLASS

 Smoked

 Bronze

SELECTED METAL

 Black matte

SELECTED WOOD

 Natural Oak

 Walnut

 Dark Oak



Black matte metal finished leg



Walnut frame with bronze glass



Smoked glass frame

Designed by Enrico Azzimonti

Unootto Gold

Also available in 10 Players



MATERIALS

Low-iron glass frame
Selected gold plated legs and components
Marble top structure
Alcantara® playing surface

PRODUCT WEIGHT

110 Kg / 242.5 lbs

PACKAGING INFORMATION

142 cm x 142 cm x 40 cm (h)
60" x 60" x 16" (h)
205 kg / 452 lbs

SELECTED GLASS



Transparent

SELECTED METAL



Gold plated

SELECTED MARBLE



Bianco di Carrara



Bardiglio Nuvolato



Nero Marquina



Gold plated metal leg



Bianco di Carrara marble frame

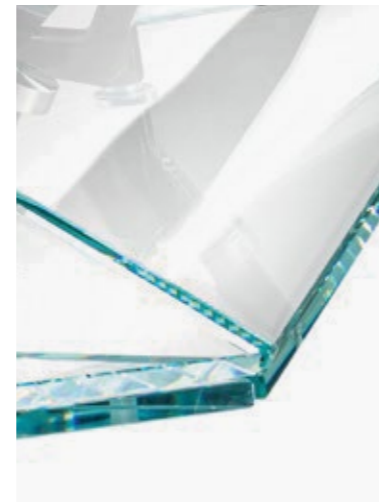

Low-iron glass frame

Unootto 10 Players



MATERIALS

Transparent, bronze or smoked glass
Chrome or black matte finished metal legs and components
Marble or wood top frame
Alcantara® playing surface

PRODUCT WEIGHT

140Kg / 309lbs

PACKAGING INFORMATION

221cm x 141cm x 48cm (h)
87" x 55" x 19" (h)
304 kg / 670 lbs



Chrome metal finished leg

SELECTED MARBLE



Bianco di Carrara



Bardiglio Nuvolato

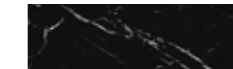

Nero Marquina



Nero Marquina marble frame

SELECTED WOOD



Natural Oak



Walnut



Dark Oak



Walnut inner top frame

Unotto Accessories

**Poker Game Set**

Design by IMPATIA R&D
Handcrafted from leather
10 colors available. Made in Italy

DIMENSIONS AND WEIGHT
35,6 cm x 35,6 cm x 6,5 cm (h)
14" x 14" x 2.5" (h)
Gross Weight: 8kg / 17 lb

**Cup Holders**

Design by Enrico Azzimonti
Handcrafted from leather.
10 colors available. Made in Italy

DIMENSIONS
12 cm Ø x 7 cm(h)
4.7" Ø x 2.7" (h)

Designed by Enrico Azzimonti

Unotto Removable Top

FENIX custom top
Made in Italy

DIMENSIONS AND WEIGHT
122 cm x 122cm x 1cm
48" x 48" x 0.4"
18 kg / 39 lb

**Leather Armrests**

Design by IMPATIA R&D
Handcrafted from leather
10 leather colors available
Made in Italy

Designed by IMPATIA R&D

Tuttuno Leather



MATERIALS
 Low-iron glass structure and legs
 Chrome finished metal components
 Leather top structure p. 116
 Alcantara® playing field p. 116

PRODUCT WEIGHT
 35 kg / 77 lbs

GAME OPTIONS

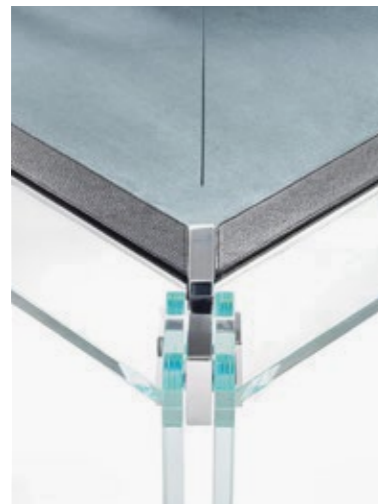

Mahjong



Checkers



Backgammon

PACKAGING INFORMATION
 93 cm x 117 cm x 42 cm (h)
 37" x 46" x 16.5" (h)
 95 kg / 209 lbs

SELECTED METAL

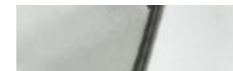

Chrome

Tuttuno Accessories



Leather Armrests
 Handcrafted from leather
 10 Leather colors available
 Made in Italy

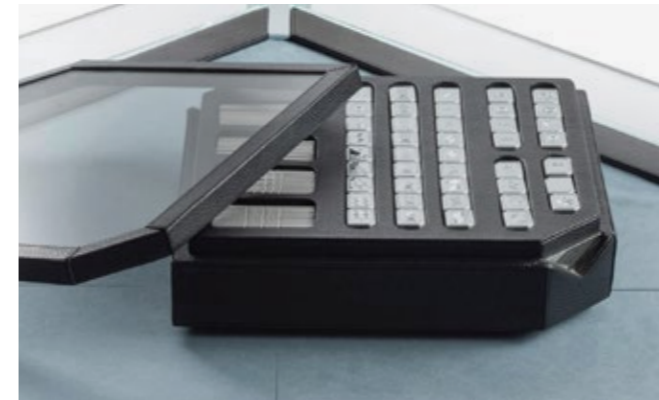

Mahjong Game Set
 Handcrafted leather box with glass detailing and chrome tiles
 10 Leather colors available
 Made in Italy

DIMENSIONS AND WEIGHT
 32.6 cm x 32.6 cm x 8.5 cm (h)
 12.8" x 12.8" x 3.3" (h)
 Gross Weight: 8kg / 17 lb



Backgammon Game Set
 Handcrafted leather box with chrome checkers
 10 Leather colors available
 Made in Italy

DIMENSIONS AND WEIGHT
 30.5 cm x 7.5 cm x 7.5 cm (h)
 12" x 2.9" x 2.9" (h)
 Gross Weight: 1.5kg / 3.3 lb

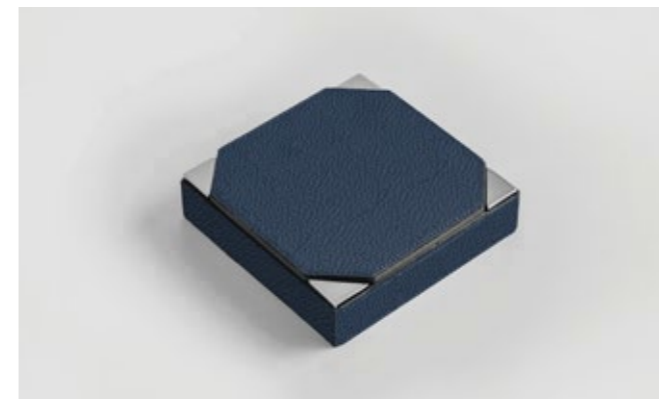

Checkers Game Set
 Handcrafted leather box with chrome checkers
 10 Leather colors available
 Made in Italy

DIMENSIONS AND WEIGHT
 30.5 cm x 7.5 cm x 7.5 cm (h)
 12" x 2.9" x 2.9" (h)
 Gross Weight: 1.5kg / 3.3 lb

Precious Leather Collection

**Billiard**

Design by IMPATIA R&D
Crocodile box with glass and metal detailing.
Available in a range of 6 colors.
Made in Italy

DIMENSIONS AND WEIGHT

36.3 Ø x 8.5 cm
14.3" Ø x 3.3"
Gross Weight: 5kg / 11 lb

**Poker**

Design by IMPATIA R&D
Crocodile box with glass and metal detailing.
Available in a range of 6 colors.
Made in Italy

DIMENSIONS AND WEIGHT

35.6 cm x 35.6 cm x 6.5 cm (h)
14" x 14" x 2.5" (h)
Gross Weight: 8kg / 17 lb

**Cup Holder**

Design by Enrico Azzimonti
Crocodile with interior metal detailing.
Available in a range of 6 colors.
Made in Italy

DIMENSIONS

12 cm Ø x 7 cm (h)
4.7" Ø x 2.7" (h)

**Mahjong**

Design by IMPATIA R&D
Crocodile box with glass and metal detailing.
Available in a range of 6 colors.
Made in Italy

DIMENSIONS AND WEIGHT

32.6 cm x 32.6 cm x 8.5 cm (h)
12.8" x 12.8" x 3.3" (h)
Gross Weight: 8kg / 17 lb

**Backgammon**

Design by IMPATIA R&D
Crocodile box with glass and metal detailing.
Available in a range of 6 colors.
Made in Italy

DIMENSIONS AND WEIGHT

30.5 cm x 7.5 cm x 7.5 cm (h)
12" x 2.9" x 2.9" (h)
Gross Weight: 1.5kg / 3.3 lb

**Checkers**

Design by IMPATIA R&D
Crocodile checkers box with metal detailing.
Available in a range of 6 colors.
Made in Italy

DIMENSIONS AND WEIGHT

16 cm x 16 cm x 4 cm (h)
6.2" x 6.2" x 1.5" (h)
Gross Weight: 1.2kg / 2.6 lb

Lungolinea Selected Alcantara



Anthracite



Powder



Chestnut

Unotto and Tuttuno Selected Alcantara



Anthracite



Pearl



Sky



Powder



Sea Sand



Fern



Terra

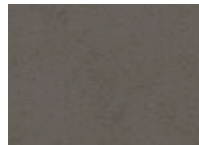

Stone



Pompeian



Cyclamen

Lungolinea, Unotto and Tuttuno Selected Leathers

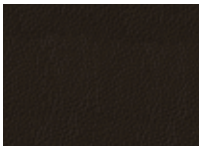

Nero

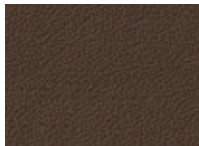

Tobacco



Vino

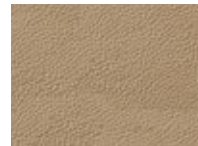

Beige



Viola

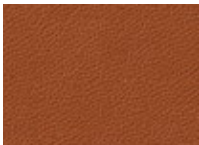

Arancio



Prato

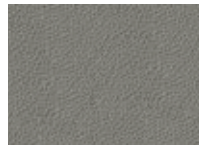

Gray

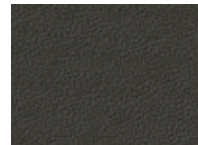

Ash



Navy

Precious Leather Game Sets Selected Leathers

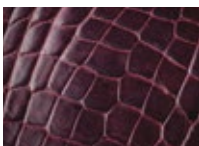

Burgundy

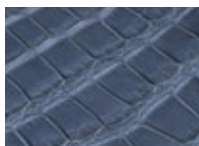

Deep Blue



Bright Orange



Forest Green



Smoked Gray



Midnight Black



ADW SPORTS

SPORTS & ENTERTAINMENT DIVISION OF
ADMIRALWORLD GENERAL TRADING LLC

EXCLUSIVE DISTRIBUTOR OF:

IMPATIA®



TEQBALL
WORLD IS CURVED

STIL-FIT INT.



RILEY®
ENGLAND



OUR ADDRESS:

ADMIRAL WORLD General Trading LLC P.O Box 112661 Str.8
Showroom 46, Al Quoz 1, Dubai, United Arab Emirates

Call Us:

M: +971 50 865 6575

For Sales Enquiries:

sales@admiralworld.com



Follow us
[admiralworldsports](https://www.instagram.com/admiralworldsports)

www.adw-sports.store