

LEITNER

H E A D S E T S



LH380

LEITNER

H E A D S E T S

WHEN THE CALL COUNTS

CONTENTS

Understanding your...

Headset controls	4
Charging base	5
Indicator lights	6
Audio signals	7

How to...

Set up your headset	8
Connect to Bluetooth	11
Make a landline call	12
Make a Bluetooth call	13
Answer a call	14
Use UniBase® Technology	15
Control your volume	16
Activate auto-on feature	17
Turn on call control	17
Connect a 2nd headset for conference calls or training	18
Register a new primary headset	20

Troubleshooting & Frequently Asked Questions	21
--	----

Health and Safety Instructions	22
--------------------------------------	----

UNDERSTANDING YOUR HEADSET CONTROLS

- A** Incoming Volume Up
- B** Microphone Mute Button
- C** Incoming Volume Down
- D** Headset ON/OFF (and Online Indicator)

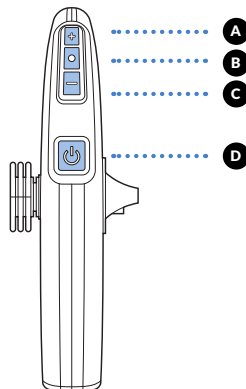

WHAT'S IN THE BOX

Headset

Charging Base

Lithium-Ion Battery

Battery Door

Replacement Ear Tips

Foam Windscreen

8.5v AC Adaptor

RJ-9 Phone Cord

Type A-to-Mini USB Cord

UNDERSTANDING YOUR CHARGING BASE

- 1 Battery Indicator
- 2 Computer Mode Button
- 3 Bluetooth Mode Button
- 4 Telephone Mode Button
- 5 Indicator Lights (see page 6)
- 6 USB Connector Port
- 7 Power Port
- 8 AUX Port
- 9 Telephone Connector Port
- 10 Handset Connector Port
- 11 Microphone Volume Up/Down
- 12 Accessory Selection Switch
- 13 Compatibility Switch

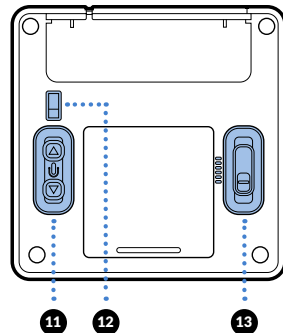
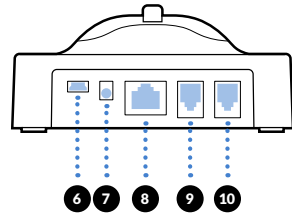
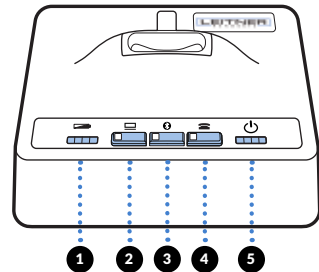

UNDERSTANDING THE INDICATOR LIGHTS

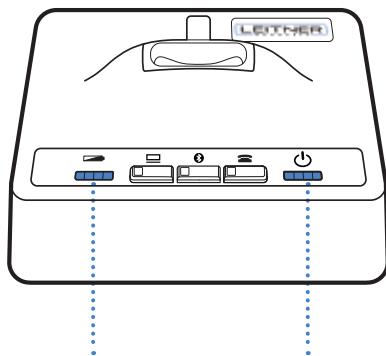

Battery Lights

25%	50%	75%	100%
-----	-----	-----	------

When the headset battery is below 20%, the first battery light will flash.

Indicator Lights

1	2	3	4
---	---	---	---

- 1 Power Light (it's plugged in)
- 2 Bluetooth Indicator* (it's connected)
- 3 Online Indicator (headset is on)
- 4 Charging Light (off when at 100%)

* This light will turn off when your headset is in the charging base. It does not mean your Bluetooth has disconnected.

UNDERSTANDING THE AUDIO SIGNALS

SOUND	WHAT IT MEANS
2 quick beeps (60 sec repeat)	Low battery
2 beeps	Nearly out of range
2 pitch tone	Out of range
2 rapid beeps	Back in range
1 beep	Receiver volume up/down
2 pitch tone (8 sec repeat)	Mute is on
1 beep	Mute off/on

When you walk out of range of the base, you will hear warning beeps in the headset. If the headset disconnects due to being out of range, the call will not drop. The headset will automatically reconnect when you are back in range.

NOTE: *If you do not move back in range within 5 minutes, the call will disconnect.*

HOW TO

SET UP YOUR HEADSET

- 1 Plug the power adaptor into the charging base. The power light on the base will light up. *We recommend charging your headset for at least 4 hours before use.*

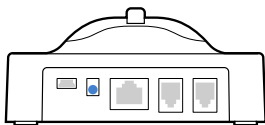

Power port

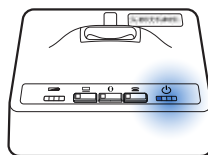

Power light

- 2a CONNECTING TO A TELEPHONE WITH A HEADSET JACK** Use the included connector cord to connect the telephone port on the base to the headset port on your desk phone. You may need to adjust the compatibility switch on the bottom of the base to find the correct setting for your phone model. Most phones use 1. Cisco phones should be set to 4 only when using the headset jack.

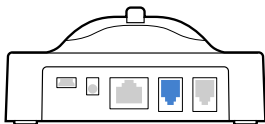

Telephone port

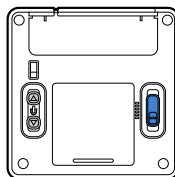

Compatibility switch

- 2b CONNECTING TO A TELEPHONE WITHOUT A HEADSET JACK** Connect the curly cord of your handset to the handset port on the charging base. Use the included connector cord to connect the telephone port on the charging base to the handset jack on your desk phone. See 2a on using the compatibility switch.

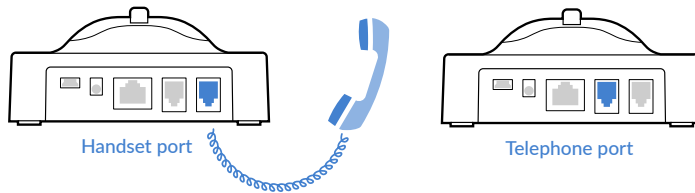

- 3 CONNECTING TO A LEITNER HANDSET LIFTER (OPTIONAL)** Connect your headset to your desk phone as shown in Step 2b. Attach the handset lifter to your desk phone and connect it to the AUX port on the charging base. Set the accessory selection switch on the bottom of the base to RHL. See the included user guide or go to headsets.com/LifterSetup for more help.

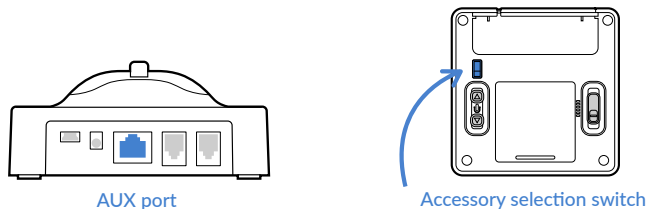

- 4 CONNECTING TO A LEITNER ELECTRONIC HOOKSWITCH (EHS) CABLE (OPTIONAL)*** Each office phone is a bit different so please refer to the EHS cable instructions for quick and easy setup.

* With a handset lifter or EHS cable connected, you'll be able to answer and end calls using the ON/OFF button on the headset—up to 350 feet away from your desk!

- 5 CONNECTING TO YOUR COMPUTER** Use the included USB cable to connect the charging base to an available USB port on your computer. If your computer doesn't recognize the device after a minute, go to your sound settings and select "DECT Headset" as both your default microphone and default speakers.

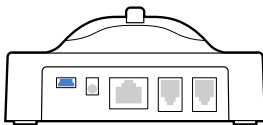

USB port

We'd love to help you get set up!

Call us at 1-800-432-3738, Monday through Friday 6:00am-4:30pm Pacific Time

HOW TO

CONNECT TO BLUETOOTH

- 1 With your headset turned off, hold down the Bluetooth button (1) for three seconds until the light starts flashing.
- 2 Make sure Bluetooth is enabled on the device you're trying to connect to. On most devices like iPhone or Android, this can be found in your settings menu.
- 3 Select 'DECT Headset' from the list of available devices (2).
- 4 The light on your charging base will stop flashing once it's successfully connected.

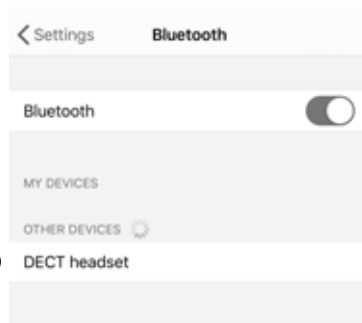
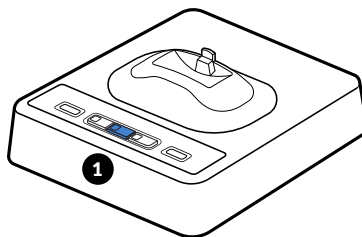

HOW TO

MAKE A LANDLINE CALL

- 1 Make sure telephone mode is on (1).
- 2 Press the ON/OFF button (2).
- 3 Press the headset button on your telephone or you can lift the phone handset if yours doesn't have one. If you have a handset lifter or electronic hookswitch (EHS) cable connected to the charging base, the line will automatically connect.
- 4 Dial the number you're calling.
- 5 To end the call: Place the headset on the charging base or press the ON/OFF button (2). If you have a handset lifter or an EHS cable, the call will disconnect automatically. If not, then manually hang up the phone.

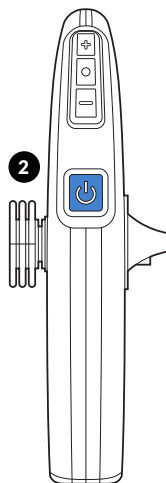
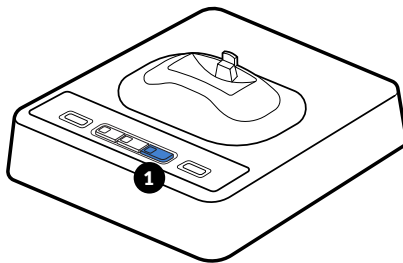

HOW TO

MAKE A BLUETOOTH CALL

- 1 Ensure your Bluetooth device is successfully connected to your charging base by following the steps on page 11.
- 2 Make sure Bluetooth mode is on (1).
- 3 Press the ON/OFF button (2).
- 4 Dial your call on your Bluetooth device as you normally would.
- 5 Depending on your device's settings, you may need to change the audio source on your device to 'DECT Headset' (most devices will connect automatically).
- 6 To end the call you can either:
 - Press the ON/OFF button (2)
 - Place the headset on the charging base
 - Manually end the call from your device

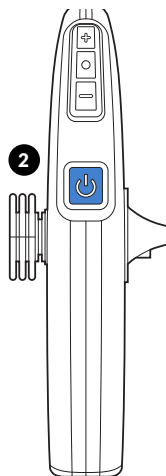
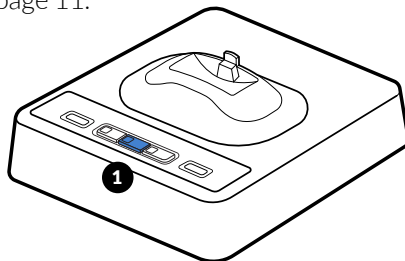

HOW TO

ANSWER A CALL

For incoming landline call:

- 1 Press the ON/OFF button (1) and make sure your base is in telephone mode (2).
- 2 Press the headset button on your phone. If your phone doesn't have a headset button, simply lift the handset to activate the call.*

* If you have a handset lifter or EHS cable connected to the charging base, the call will connect automatically.

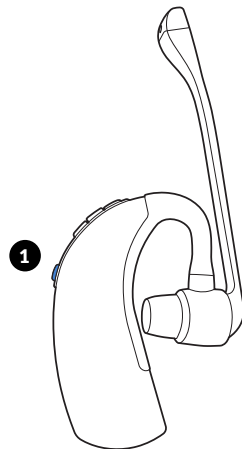

For incoming Bluetooth call:

- 1 Press the ON/OFF button (1) and your call will connect automatically.

To end the call:

- 1 Press the ON/OFF button (1) or place the headset on the charging base.
- 2 Manually hang up the call from your landline phone or Bluetooth device.*

* If you have a handset lifter or EHS cable connected to the charging base, the call will end automatically.

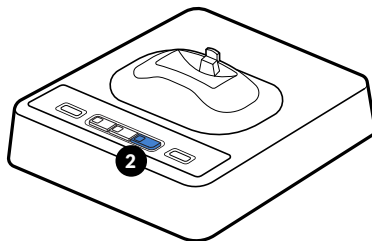

HOW TO

USE UNIBASE[®]

UniBase Technology allows you to conference calls between any two devices. Have a call on your cell phone and one on your landline? Conference them together with UniBase!

- 1 Begin a call on your first device.
- 2 Hold the mode button for the second device you want to add: Computer (1), Bluetooth (2) or Telephone (3).
- 3 After a few seconds, the mode button lights for the two selected devices will light up.
- 4 To exit UniBase mode, simply press the mode button of the device you want to stay on with.

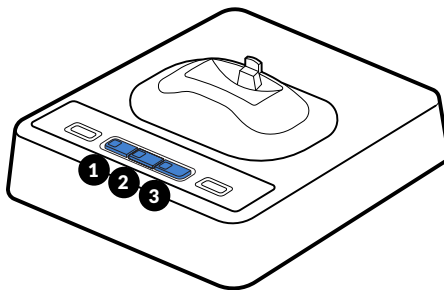

Sounds from your computer will be shared automatically with the conference call

HOW TO

CONTROL YOUR VOLUME

To adjust the headset listening volume:

While the headset is on, use the Incoming Volume Up button (1) to increase or Incoming Volume Down button (2) to decrease. The headset will beep each time the volume is adjusted.

To mute the headset microphone:

Press the mute button (3). While in mute mode, the headset will beep every 8 seconds. To unmute, press the mute button again.

To adjust the headset microphone volume:

Use the volume control buttons on the bottom of the headset base (4 or 5).

To adjust the ring detection volume:

If you're using a handset lifter or EHS cable, you'll hear a ring tone in your headset when you have an incoming call.

While the headset is off, use the volume control buttons (1 or 2) on the headset to adjust the headset's ring tone and notification audio signals.

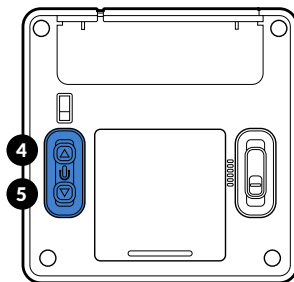
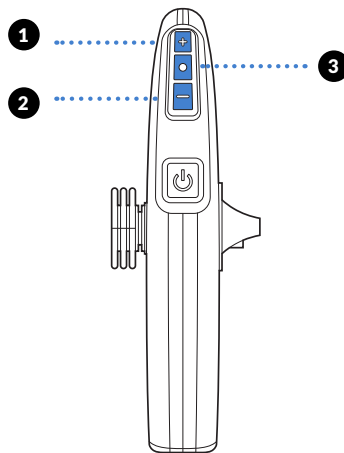

HOW TO

ACTIVATE AUTO-ON

Turn this feature on if you'd like your headset to turn on automatically when you pick up your headset off the charging base.

To turn this feature on: With your headset turned off, hold the + and – buttons (❶) on your headset together for three seconds. Once auto-on is activated, the light on your headset will flash *slowly*.

To turn this feature off: Follow the same steps again. This time the light on your headset will *quickly* flash.

HOW TO

TURN ON CALL CONTROL

Your Leitner Headset can answer and end Skype for Business calls directly from your headset.

To turn this feature on: Hold the up button (❷) on the bottom of your charging base together with the Computer Mode button on the top of your base for three seconds. Your base will quickly flash 6 times to confirm.

To turn this feature back off: Hold the down button (❸) on the bottom of your charging base together with the Computer Mode button on the top of your charging base for three seconds. Your base will flash 6 times to confirm.

HOW TO

CONNECT A SECONDARY HEADSET FOR

- 1 Turn on the primary headset.
- 2 With the secondary headset turned off, place it on the charging base.
- 3 After a moment, the secondary headset's online indicator light (1) will turn on and the primary base's online indicator light (2) will flash to show that the headset is registering with the base unit.
- 4 Once the registering has completed, the base's online indicator light (2) will stop flashing and the headset's online indicator light (1) will begin flashing.

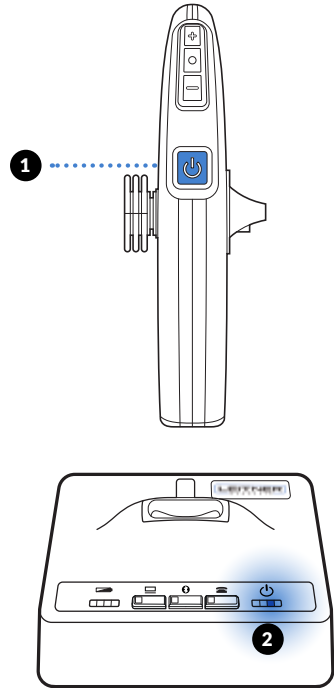

TRAINING OR CONFERENCE CALLS

- 5 If the secondary headset has Auto-On enabled, it will automatically connect when you lift it from the base. If it has Auto-On disabled, press the ON/OFF button (1) on the headset to connect.

NOTE: *The secondary headset will remain registered to the base until the primary headset is turned off or if either headset is returned to its original base. It takes about ten seconds for the secondary headset to re-register to its original base.*

Your LH380 can be conferenced with any on-the-ear Leitner wireless headset

HOW TO

REGISTER A NEW PRIMARY HEADSET

In the event that you need to replace your headset, you'll need to register the new headset to your charging base

- 1** Press and hold the telephone button (❶) for five seconds. The light will flash showing the base is in registration mode.
- 2** With your headset off, press and hold the mute button (❷) until it begins to flash (about five seconds) to make the headset enter registration mode.
- 3** Keep the headset out of the base until the light on the telephone button (❶) turns solid.
- 4** The headset will now be registered to the base. When the registration has completed, the light will stop flashing. The whole process should take about 30 seconds.

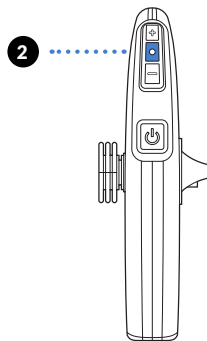
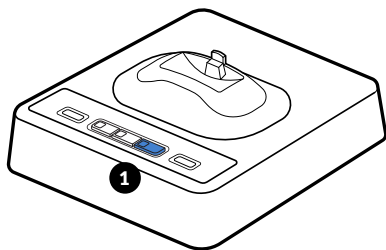

FREQUENTLY ASKED QUESTIONS

- Q. I don't have any battery lights on my headsets base and its been charging for more than 4 hours.**
- A.** Start by unplugging the power to the headset base, then remove the battery from the headset for 30 seconds. Reinstall the battery making sure the Leitner logo is facing you. Plug the power back into your base. Press and hold the Telephone Mode button on the base until it flashes, then press and hold the Mute button on the headset until it flashes. Finally, place the headset next to the base (don't place it in your charging base until the Telephone Mode light goes solid).
- Q. My headset is charged and turned on but I can't hear anything.**
- A.** If you set up your headset through the headset jack, make sure your telephone's headset button is on. Check the compatibility switch underneath your base is set to 1. Most Cisco phones should be set to 4.
- Q. I can't get my headset to work with my computer.**
- A.** Make sure the USB cord is connected between your charging base and computer. If your computer doesn't automatically recognize your headset, go to your computer's sound settings and make sure DECT Headset is selected as your output and input device. Your sound settings can be found on most Windows computers by searching 'sound settings' in your search bar.
- Q. I can hear people on the phone but they can't hear me.**
- A.** Try adjusting the microphone volume from the controls underneath the charging base. Call us at 1-800-432-3738 and we'll make sure you sound perfect!

HEALTH AND SAFETY

INSTRUCTIONS

It might seem a bit silly, but we're required to tell you these safety instructions about your Leitner headset. Please keep these instructions for your reference. When using this product, these basic safety precautions and warnings should be followed to reduce the risk of fire, electrical shock, injury to persons, and damage to property.

Operating, charging and storage temperatures are 32 °F to 104 °F (0 °C to 40 °C).

General Warnings

- Never allow children to play with the product; small parts may be a choking hazard.
- Do not disassemble the product or AC adaptor as this may expose you to dangerous voltages or other risks. Incorrect reassembly can cause electric shock or fire when the product is subsequently used.
- Do not insert anything into the product because this may cause damage to the internal components or cause personal injury.
- Avoid contact with liquids. Do not locate this product near water, for example, near a bathtub, or sink, in a wet basement, or near a swimming pool.
- Discontinue use of product if the product overheats, has a damaged cord or plug, has been dropped or damaged, or if the product has come into contact with liquids.
- This product should never be placed over or near a heat source and should not be placed in locations which do not have proper ventilation.
- If you experience skin irritation after using this product, discontinue use.

Charging Warnings

- Use only the charger provided with your headset to charge the product. Do not use the charger for any other purpose. Ensure that the voltage rating corresponds to the power supply you intend to use.
- Charge the headset according to the instructions supplied with the unit.
- Plug the AC adaptor into an outlet that's near the headset and is easily accessible.

Headset Battery Warnings

- The headset is equipped with a replaceable battery. To reduce the risk of fire or injury to persons read and follow these instructions.
- Do not dispose of the battery in a fire. The battery may explode. Check your local laws for disposal instructions.
- Do not open or mutilate the battery. There may be corrosive materials which can cause damage to eyes or skin and may be toxic if swallowed.
- Never charge the battery where the temperature may fall below 32 °F (0 °C) or rise above 104 °F (40 °C).

RECYCLING: *Your battery used in the headset must be recycled or disposed of properly. Contact your local recycling center for proper disposal of your headset battery.*

To Protect Your Hearing

- Set the volume in a low position before putting on your headset
- Avoid turning up the volume to block out noisy surroundings.
- Limit the amount of time you use headsets at high volume levels.
- Turn the volume down if the sound from the headset prevents you from hearing people speaking near you.



For live product support

1-800-432-3738

Mon-Fri 6:00am-4:30pm Pacific Time

www.leitnerheadsets.com