

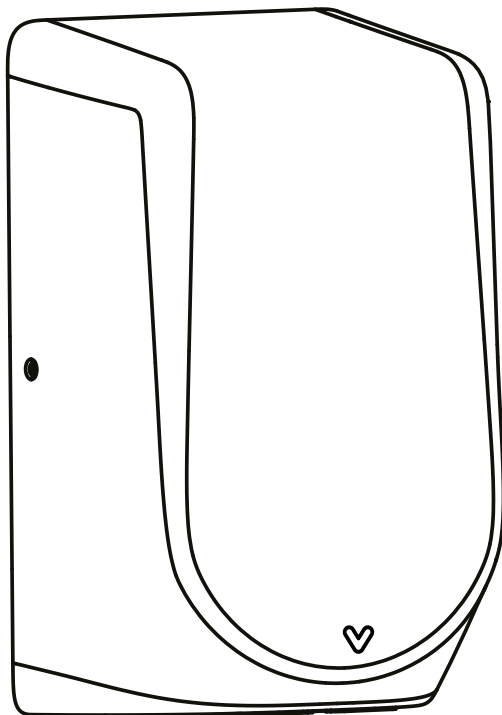

User Manual

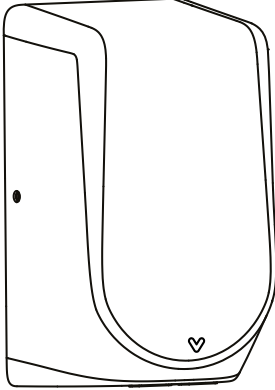

TECHNICAL SPECIFICATIONS

	Item Category	Performance Data	
	Operating Voltage	AC 220~240V, 50 Hz- 60 Hz	
	Rated Power Standard Mode	220~240V	840W
	Rated Power Quiet Mode 'on'	220~240V	250W
	Standby Power	≤ 1W	
	Air Speed	100 m/s	
	Motor Type	Brushed Motor, 30,000 RPM	
	Sensor Type	Auto Infrared touch free operation	
	Sensor Range	45° 15~25cm	
	Timing Protection	50 seconds auto shut off	
	Drying Time	10 ~ 12 sec	
	IP Rating	IPX3	
	Isolation	CLASS I	
	Unit Size	H 256mm x W 174.5mm x D 110mm	

IMPORTANT SAFETY INSTRUCTIONS

WARNING – TO REDUCE THE RISK OF FIRE, ELECTRIC SHOCK, OR INJURY TO PERSONS OBSERVE THE FOLLOWING:

- Use this unit only in the manner intended by the manufacturer. The manufacturer is not responsible for any damages caused by misuse or defective installation.
- The instructions contained within the installation template must be followed carefully when installing this unit. Failure to accurately follow the instructions may result in the incorrect operation of this unit, damage to property and/or personal injury.
- Installation work and electrical wiring must be done by qualified person(s) in accordance with all applicable codes and standards, including fire-rated construction.
- When cutting or drilling into wall or ceiling, do not damage electrical wiring and other hidden utilities.
- This unit must be powered by a dedicated circuit branch protected by a circuit breaker with the appropriate rating. The correct circuit cable must be used to meet the current consumption for this unit.
- This unit has been designed for indoor use only. Protect from water, sun and extreme temperatures. Do not install outdoors or close to moisture and/or heat generators.
- This unit cannot be modified. Qualified person(s) must be used for maintenance, any repair work or unit removal. If the units stops or works incorrectly, contact your regional dealer or contractor.
- This appliance can be used by children aged from 8 years and above and persons with reduced physical, sensory or mental capabilities or lack of experience and knowledge if they have been given supervision or instruction concerning use of the appliance in a safe way and understand the hazards involved. Do not allow children to play with the appliance or carry out cleaning and/or user maintenance on this hand dryer.
- If the supply cord is damaged, it must be replaced by the manufacturer, its service agent or similarly qualified persons in order to avoid a hazard.

UNPACKING

1. Remove all packing material. Recycling is recommended.
2. Carefully remove the hand dryer from the shipping carton, using care not to drop the appliance.
3. Inspect carefully for any damage that may have occurred during transit. Check for any loose, missing or damaged parts. If the hand dryer is damaged, promptly inform the shipper or dealer where you purchased it.

Standard items with the hand dryer are shown in fig.1 together with tools needed by the installer.

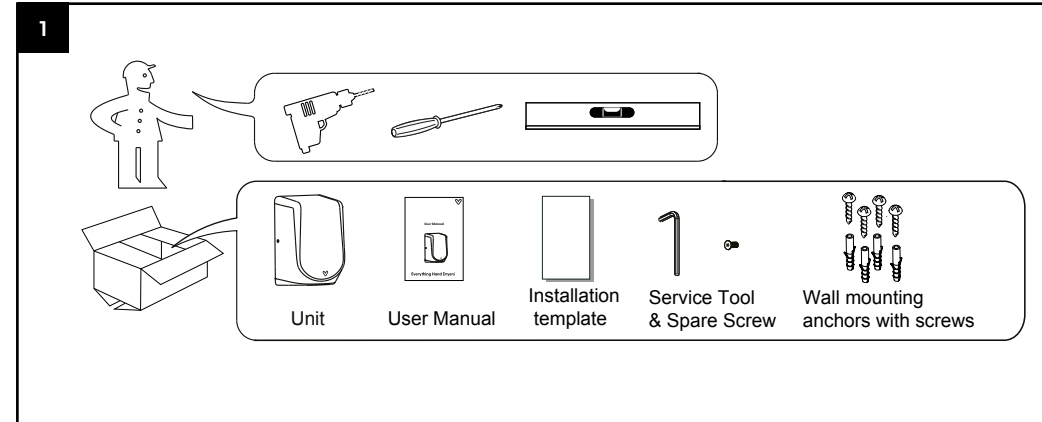

INSTALLATION

- 1.1 Place the main cover on a cloth to avoid marking its surface.
- 1.2 Remove the side security screws using the service tool (fig. 2).
- 1.3 Lift the front cover off the main body (fig. 3).

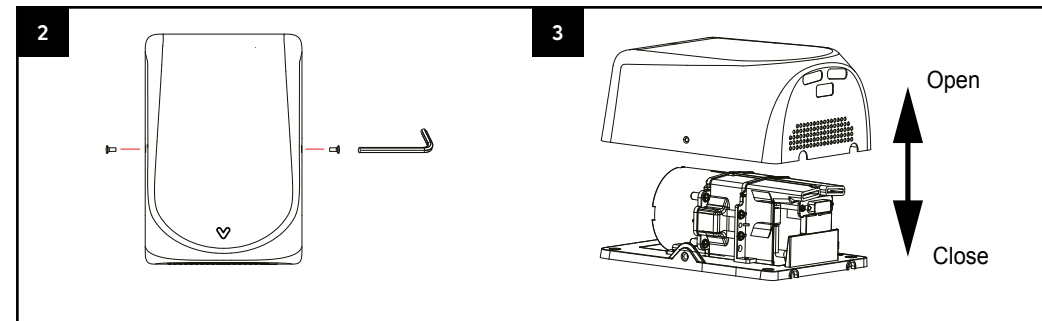

CAUTION

- Make sure power supply breaker is switched off.
- Check that the electrical supply corresponds to that shown on the rating plate. If the unit is connected to any electrical supply other than stated on the rating plate of the unit, permanent damage or unsafe operation of the unit may result.
- The unit must be mounted on a flat vertical wall capable of supporting the full weight of the unit.

2. Positioning

2.1 Mark the location on the wall with a pencil. Use the Installation Template to mark to locations for the four fixing points (fig. 4).

2.2 Pre-drill the wall in the marked locations using 5/16" (8mm) drill, insert the plastic anchors and tap flush to the wall. If the cable entry is to be done from the wall provide a proper cable exit (fig.5).

When installing above any surface, the distance from the bottom of the dryer must be a minimum of 700mm. Recommended height measurements for specific user groups can be found on the Installation Template.

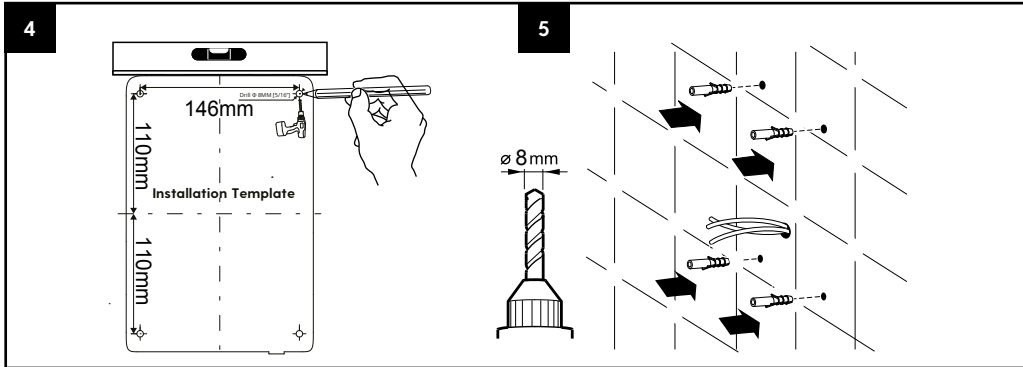

3. Installing Power cable and Connection terminal block

WARNING ENSURE POWER IS NOT CONNECTED

3.1 Pull the cable through the hole in the back panel. Ensure the cable is long enough to the terminal block (fig. 6).

3.2 The cable must sit in the dedicated TerraSafe channel (fig. 6B)

3.3 As shown, connect cable to terminal block.

3.4 Should the live cable be fed through the cable entry port on the base of the dryer, the cable restraining clamp must be fitted (fig. 6).

4. Fix the cover to the main unit and insert and tighten the security screws seated on the side surface.

5. Turn power on and test the unit for correct operation.

CAUTION: Connect the ground wire to the terminal block marked "⊕". The earth/ground cable must be fitted in all installations.

Do not over-tighten and crush the power cable.

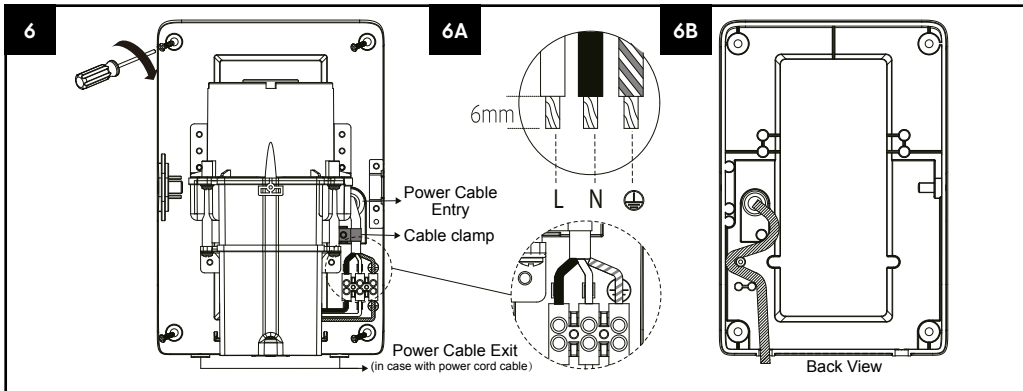

QUIET MODE (Q) SWITCH

Quiet Mode (Q) Switch (factory default setting 'OFF')

WARNING: ENSURE POWER IS NOT CONNECTED

1. Remove 2 side security screws, using the service tool (fig. 2).
2. Lift the front cover off the main body (fig. 3).
3. To change to Quiet Mode, push the switch to the right 'ON' as shown in fig. 7.
4. Reposition the front cover on the unit.
5. Re-fix the screws situated on the sides of the front cover.

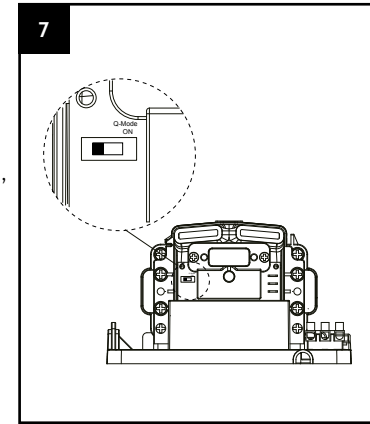

USE

1. No touch operation.
2. Shake excess water from hands.
3. Place hands under the outlet to start operation (fig. 8)
4. Slowly move hands back and forth under the outlet at the bottom of the dryer.
5. A blue LED light situated at the bottom of the dryer appears with the dryer operation.
6. The dryer stops when hands are removed.
7. The dryer will auto shut off after 50 seconds of uninterrupted use.

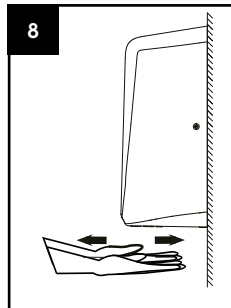

MAINTENANCE AND CLEANING

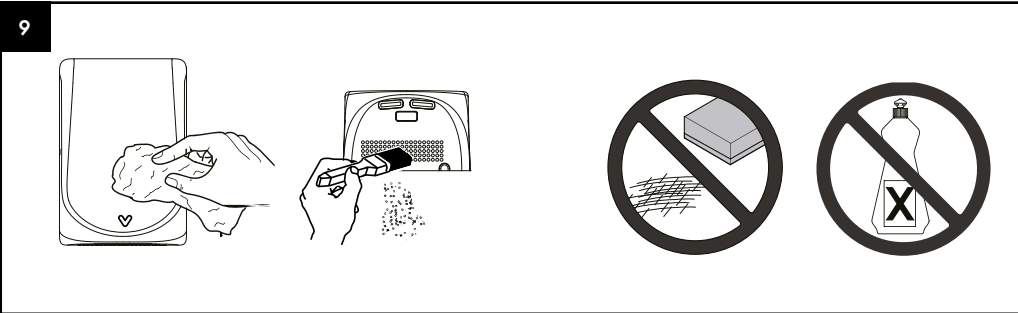

Regular maintenance.

Regularly clean the outer casing using a soft, damp cloth to gently wipe away any dirt.

 **CAUTION Never use abrasives or chemicals to clean the cover. Do not soak.**

Periodical deep clean.

1. Cleaning maintenance must not be taken until the unit has been removed from the wall or power is not connected.
2. Use the service tool to remove the security screws from the cover.
3. Remove the cover.
4. Clean all dust and lint from the interior of the hand dryer.
5. Replace the cover and fix security screws .
6. Wipe the cover with a damp cloth.

WARRANTY

THREE YEAR WARRANTY. We warrant the model covered in this manual to the original user against any defects in workmanship or materials under normal use for a period of three (3) years from the date of purchase. However, this warranty excludes damages resulting from normal wear and tear, motor burnout, incorrect use, incorrect installation, and any consumable parts (such as H13 filters etc).

If any part of the product is found to be defective in material or workmanship and returned to an authorised party, we will repair or replace the defective part. Please note that in the first instance, you should contact your retailer or supplier for details on how to claim a warranty repair or replacement.

Please be advised that our warranty does not cover damages resulting from misuse, abuse, or any modifications made to the product. Additionally, any repairs or replacements made outside of our authorised service centres will void the warranty.

By purchasing and using our product, you acknowledge and accept the terms of this warranty. We reserve the right to determine the validity of any warranty claims and to amend or revoke this warranty at any time without prior notice.

PRODUCT SUITABILITY. We understand that various jurisdictions have their own codes and regulations that govern the sales, construction, installation, and/or use of products for specific purposes. While we strive to ensure that our products comply with these codes and regulations, we cannot guarantee compliance nor be held responsible for the installation or use of our products.

We strongly advise that you review the product application and all applicable national and local codes and regulations before purchasing and using our products. It is your responsibility to ensure that the product, installation, and use are in compliance with these codes and regulations.

By purchasing and using our products, you acknowledge and accept the responsibility for complying with all applicable codes and regulations. Our warranty does not cover any damages or liabilities resulting from non-compliance with these codes and regulations.

