

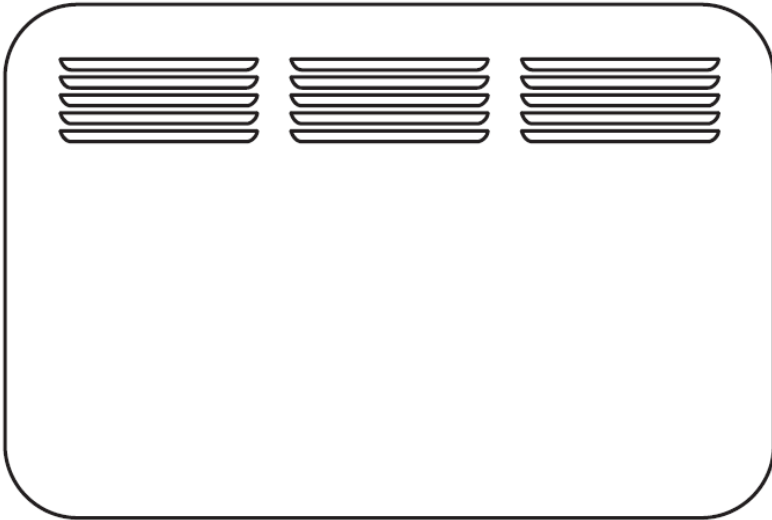

## Wifi panel convector heater

Always read this instruction manual before installing or using your appliance and always keep for future reference



**Model# HPH01B-05E1W/10E1W/15E1W/20E1W**

## Safety Advice

READ THIS NOTICE CAREFULLY BEFORE OPERATING THE APPLIANCE.

- This appliance can be used by children aged from 8 years and above and persons with reduced physical, sensory or mental capabilities or lack of experience and knowledge if they have been given supervision or instruction concerning use of the appliance in a safe way and understand the hazards involved. Children shall not play with the appliance.
- Cleaning and user maintenance shall not be made by children without supervision.
- Children of less than 3 years should be kept away unless continuously supervised.
- Children aged from 3 years and less than 8 years shall only switch on/off the appliance provided that it has been placed or installed in its intended normal operating position and they have been given supervision or instruction concerning use of the appliance in a safe way and understand the hazards involved. Children aged from 3 years and less than 8 years shall not plug in, regulate and clean the appliance or perform user maintenance.

**CAUTION - Some parts of this product can become very hot and cause burns. Particular attention has to be given where children and vulnerable people are present.**

- If the supply cord is damaged, it must be replaced by the manufacturer, its service agent or similarly qualified persons in order to avoid a hazard.
- CAUTION: In order to avoid a hazard due to inadvertent resetting of the thermal cutout, this appliance must not be

supplied through an external switching device, such as a timer, or connected to a circuit that is regularly switched on and off by the utility.



- **WARNING:** In order to avoid overheating, do not cover the heater.
- The heater must not be located immediately below a socket-outlet.
- Do not use this heater in the immediate surroundings of a bath, a shower or a swimming pool.
- Fixed heaters are to be installed so that switches and other controls cannot be touched by a person in the bath or shower.
- Do not use this heater if it has been dropped;
- Do not use if there are visible signs of damage to the heater.
- Use this heater on a horizontal and stable surface, or fix it to the wall, as applicable.

**WARNING:** Do not use this heater in small rooms when they are occupied by persons not capable of leaving the room on their own, unless constant supervision is provided.

**WARNING:** To reduce the risk of fire, keep textiles, curtains, or any other flammable material a minimum distance of 1 m from the air outlet.

**Warning: this product shall be installed in the volume 2 only according the national wiring rules (For France NF C 15-100)**

**Note:** The drawing below is for reference only.

We suggest that you contact a professional electrician for assistance.

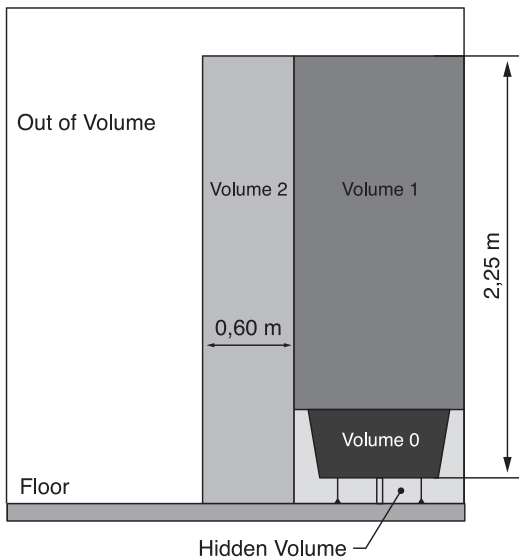

**THIS PRODUCT IS FOR ROOM HEATING**

## Installation

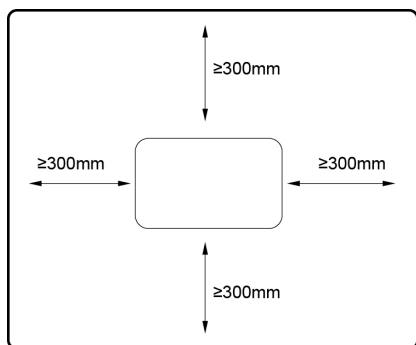

Make sure that the distance from walls and objects is respected.

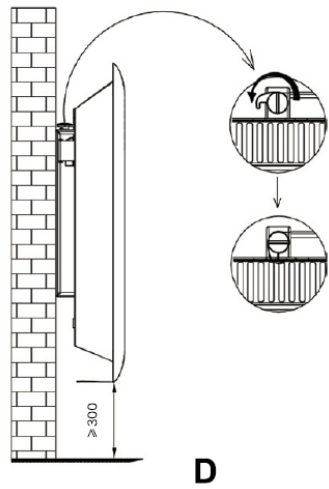
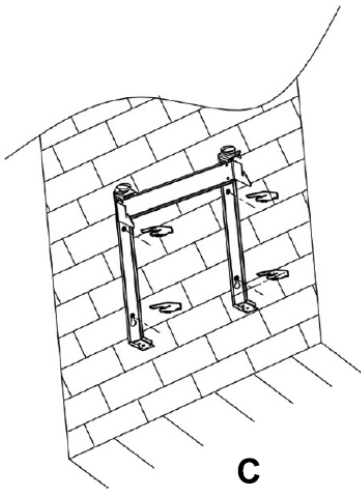
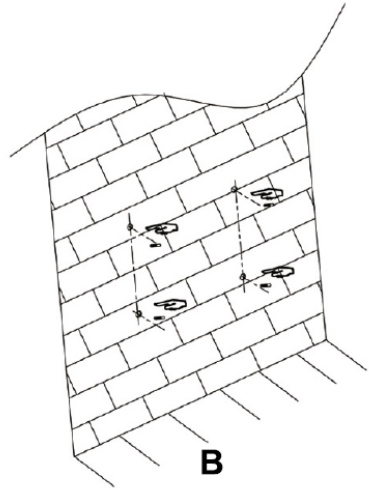
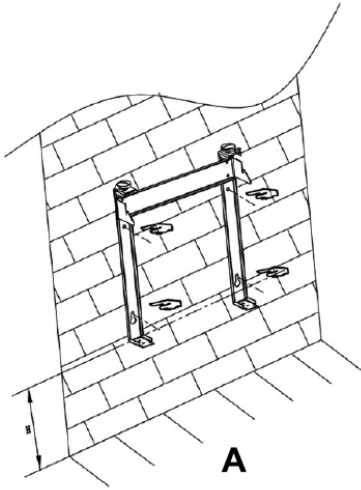

- A. Put the hanging rack on the wall as a guide ruler (please make sure the holes at parallel level) , use a mark pen to mark the hole position
- B. Drill holes on the wall with  $\phi$  8mm drill bit and insert the plastic wall plug
- C. Fasten the hanging rack on the wall with the screws,

do make sure the hanging rack is in correct direction

- D. Gently insert the heater body of the bottom to the hanging rack first and then push the heater body to be hooked on the whole hanging rack

**Warning: Be sure to keep the distance between the heater and floor, wall and so on at least 30cm.**

**Warning! When drilling holes, always check to ensure there is no wiring, pipework, etc. in the area to be drilled.**

**Warning: Before plugging in the unit make sure the radiator is properly attached to the wall. Otherwise problems can occur.**

## How to use:

### Control panel

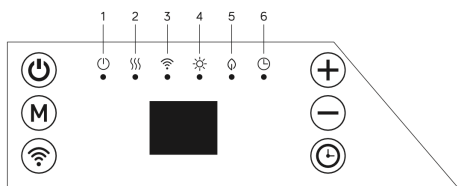

- ① Standby: on/off
- ② Heating status
- ③ Wifi
- ④ Comfort mode
- ⑤ ECO mode
- ⑥ Timer





	Standby
	Mode selection
	WIFI function
	Increase function
	Decrease function
	Timer

## How to use:









- Plug the appliance to AC 230-240V 50-60Hz socket, and press down on/off switch at the side of control box with a beep sound. The indicator light is on.
- Press to turn on the heater

- To stop the heater working, press  to turn off the heater,
- Unplug the product when it's not in use.

## Clock and day of week setting:



- Press down  3 secs to enter clock and day of week setting
- The screen display "", press  and  to select the day from 1-7.

1	Monday
2	Tuesday
3	Wednesday
4	Thursday
5	Friday
6	Saturday
7	Sunday





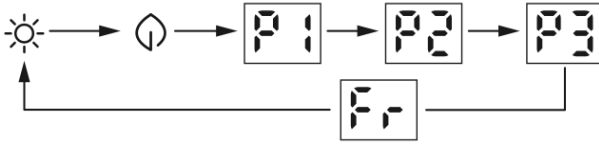

- Press  to confirm day setting and enter the clock hour setting, with the screen display: .
- Press  and  to set the current hour
- Press  to confirm hour setting and enter the minute setting, with the screen display: .
- Press  and  to set the current minute
- Press  to confirm all settings

Note: The clock and calendar will be reset to factory default if without power supply.

## Heating mode:

- Press  to enter mode selection. By pressing , heating mode runs in a continuous cycle as below:



-  Comfort mode: Press  and  to set the temperature from 5-35°C.
  -  ECO mode: Press  and  to set the temperature from 1-31 °C.  
Note: ECO mode=Comfort mode - 4 °C
  - Anti-frost mode: the screen display . The target temperature is 7 °C. The temperature can't be adjusted.
  - P1/P2/P3: Pre-set heating program.  
Note: If the clock and day setting are not finished, the first time to enter P1/P2/P3 program setting, it is requested to set day and clock setting in advance.
- P1: (Monday-Sunday) Unadjustable program



P2:(Monday-Friday) Unadjustable program



P2:(Saturday-Sunday) Unadjustable program















P3:(Monday-Friday) Adjustable program

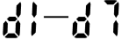





P3:(Saturday-Sunday) Adjustable program











- P3 adjustable program setting
  1. When under P3 mode, press  over 3 secs to enter day setting.
  2. The screen displays , press  and  to set from  (Monday-Sunday). Press  to confirm and enter hour setting
  3. The screen displays , press  and  to set from 00-23). Press  to choose heating mode for every hour (Comfort mode  or ECO mode  or anti-frost mode for neither 2 lights)
  4. Repeat the operation until you have completed the schedule of every hour and every day.





Note: After setting heating mode for hour 23, press  to come back to day setting.

Note: when screen displays , press  finish all setting with display of .

## Timer off function

- Press  one time, the screen display  and keeps flashing. press  and  to set timer from 0-24 hours. Press  again to confirm setting, then the indicator light  is on. The heater will then turn off after the set amount of time has passed.

## Open window function

- When the product is in status of stand-by, long press  when the screen display  or , press  or  to set the open window function on or off.
- When the heater is under working, the temperature of environment decrease 2 degrees within 2 minutes, the open window function will be activated, the heater will stop working. The screen will display like below.



- Press  to get back working.

## WiFi function.

- Use your phone to scan the QR code below or search for the “TUYA SMART” App to download and generate a free account. You can also visit [www.tuya.com](http://www.tuya.com) for more information. Please note Tuya are constantly developing and upgrading their Apps to make them more user friendly and sometimes, displays may differ slightly to the display shown in this manual due to upgrades



Select your country code, enter your mobile number and select “Get” to receive a message containing your verification code.  
Enter your verification code and select “Login”.

When the first using to turn on the heater, the WiFi indicator light will flash, connect it in the APP. Reset the WiFi, press for  3 secs, the item will “beep”, the WiFi indicator light will flash rapidly , you can now connect within the APP.

**Note: Below tuya app operation interface is just for reference.**

# A Quick connection:

Turn on your bluetooth in you mobile phone, then set as following steps.

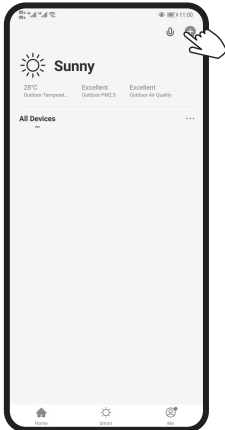

Press "+" in the right-top position and go to next step

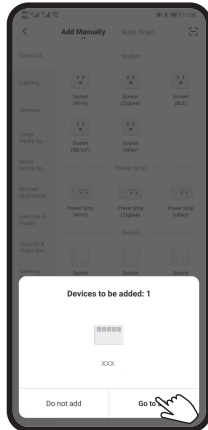

Press "Go to add"

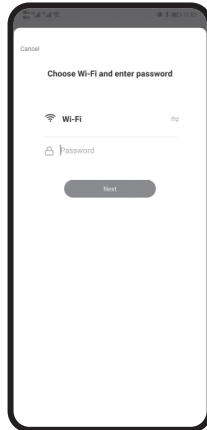

Select 2.4 GHz WiFi Network and enter the password, press next



Wait it's connected and press "Next", the APP will show as below

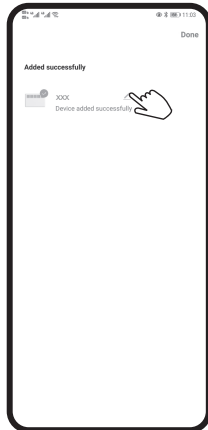

You can press to modify the name of the product

# B Normal connection

If the bluetooth is not on, pls follow the next step:

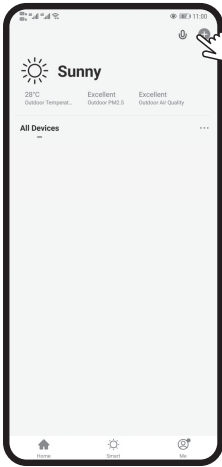

Press "+" in the right-top position and go to next step

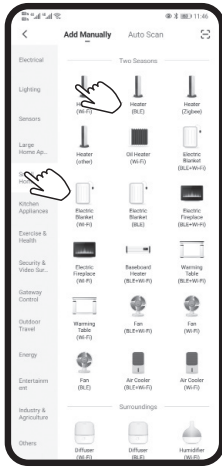

Choose small home appliance and heater

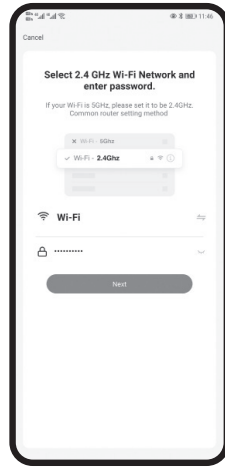

Select 2.4 GHz WiFi Network and enter the password, press next

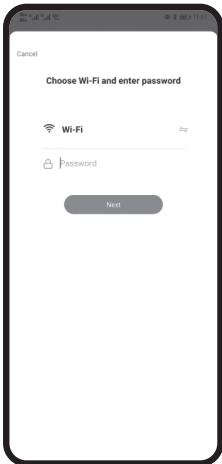

Select 2.4 GHz WiFi Network and enter the password, press next

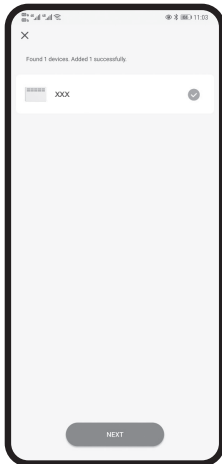

Wait it's connected and press "Next", the APP will show as below

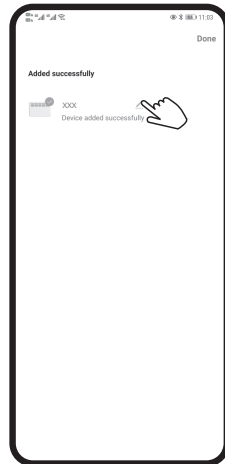

You can press to modify the name of the product

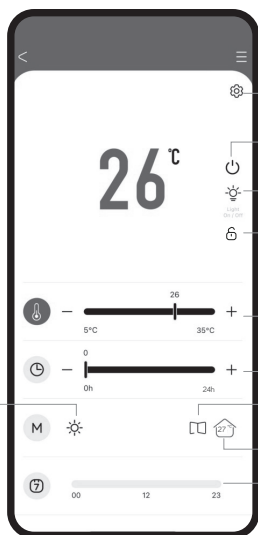

- Other functions
- Turn on/off the heater
- Night mode
- Children lock
- Target temperature setting
- Timer off
- Window open function
- Room temperature
- Smart timer

Working mode selection



- Comfort mode
- ECO mode
- P1 Weekly program P1
- P2 Weekly program P2
- P3 Weekly program P3
- Anti-frost mode
- Smart timer

Working mode selection

Please note when choosing P1/P2/P3 in the APP, the unit will operate to the settings shown in the manual. If you set P3 manually on the unit and you choose P3 in the APP the unit will operate to the settings you have set. You can also choose to set to your own requirements by selecting the Smart Timer  within the App.

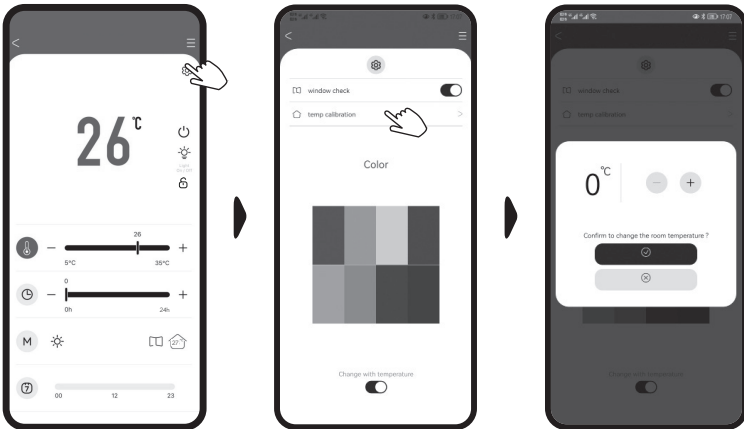
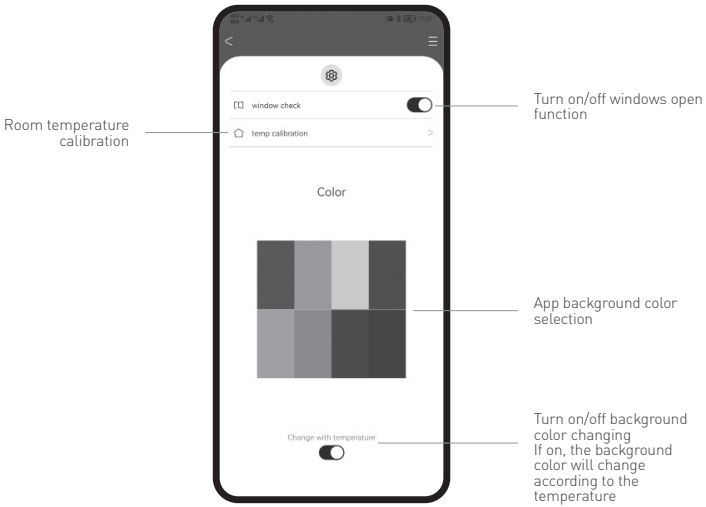

Use this function to set the Room Temperature Calibration to the correct room temperature if it is reading incorrect. Select temp calibration and then adjust temperature to current room temperature and select the tick box. The current room temperature is now set.

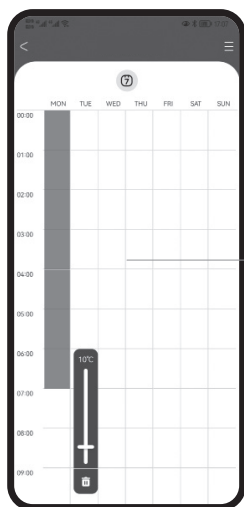

Smart timer:  
Set the working time and  
working temperature for  
every hour in everyday

## CLEANING & MAINTENANCE

- Switch off and unplug from the power supply before cleaning.
- Using a soft, moist cloth, with or without a mild soap solution, carefully clean the exterior surface of the product.
- CAUTION: Allow the product to completely cool before handling or cleaning it.
- Do not allow water or other liquids to run into the interior of the product, as this could create a fire and/or electrical hazard.
- We also recommend the periodic cleaning of this appliance by lightly running a vacuum cleaner nozzle over the guards to remove any dust or dirt that may have accumulated inside or on the unit.
- CAUTION: Do not use harsh detergents, chemical cleaners or solvents as they may damage the surface finish of the plastic components.



This marking indicates that this product should not be disposed with other household wastes throughout the EU. To prevent possible harm to the environment or human health from uncontrolled waste disposal, recycle it responsibly to promote the sustainable reuse of material resources. To return your used device, please use the return and collection systems or contact the retailer where the product was purchased. They can take this product for environmental safe recycling.

**Information requirements for electric local space heaters**

Model identifier(s): HPH01B-05E1W					
Item	Symbol	Value	Unit	Item	Unit
<b>Heat output</b>				<b>Type of heat input, for electric storage local space heaters only (select one)</b>	
Nominal heat output	P <sub>nom</sub>	0,5	kW	manual heat charge control, with integrated thermostat	[no]
Minimum heat output (indicative)	P <sub>min</sub>	0,5	kW	manual heat charge control with room and/or outdoor temperature feedback	[no]
Maximum continuous heat output	P <sub>max,c</sub>	0,5	kW	electronic heat charge control with room and/or outdoor temperature feedback	[no]
<b>Auxiliary electricity consumption</b>				fan assisted heat output	
At nominal heat output	e <sub>l,max</sub>	[no]	kW	<b>Type of heat output/room temperature control (select one)</b>	
At minimum heat output	e <sub>l,min</sub>	[no]	kW	single stage heat output and no room temperature control	[no]
In standby mode	e <sub>l,sb</sub>	0,00061	kW	Two or more manual stages, no room temperature control	[no]
Model identifier(s): HPH01B-10E1W				with mechanic thermostat room temperature control	
Item	Symbol	Value	Unit	with electronic room temperature control	[no]
<b>Heat output</b>				electronic room temperature control plus day timer	[no]
Nominal heat output	P <sub>nom</sub>	1,0	kW	electronic room temperature control plus week timer	[yes]
Minimum heat output (indicative)	P <sub>min</sub>	1,0	kW	<b>Other control options (multiple selections possible)</b>	
Maximum continuous heat output	P <sub>max,c</sub>	1,0	kW	room temperature control, with presence detection	[no]
<b>Auxiliary electricity consumption</b>				room temperature control, with open window detection	[yes]
At nominal heat output	e <sub>l,max</sub>	[no]	kW	with distance control option	[yes]
At minimum heat output	e <sub>l,min</sub>	[no]	kW	with adaptive start control	[no]
In standby mode	e <sub>l,sb</sub>	0,00061	kW	with working time limitation	[no]
				with black bulb sensor	[no]
Contact details	5-7 Bramley Business Park, Railsfield Rise, Leeds, LS13 3SA				



**Information requirements for electric local space heaters**

Model identifier(s): HPH01B-15E1W					
Item	Symbol	Value	Unit	Item	Unit
<b>Heat output</b>				<b>Type of heat input, for electric storage local space heaters only (select one)</b>	
Nominal heat output	$P_{nom}$	1,5	kW	manual heat charge control, with integrated thermostat	[no]
Minimum heat output (indicative)	$P_{min}$	1,5	kW	manual heat charge control with room and/or outdoor temperature feedback	[no]
Maximum continuous heat output	$P_{max,c}$	1,5	kW	electronic heat charge control with room and/or outdoor temperature feedback	[no]
<b>Auxiliary electricity consumption</b>				fan assisted heat output	
At nominal heat output	$el_{max}$	[no]	kW	<b>Type of heat output/room temperature control (select one)</b>	
At minimum heat output	$el_{min}$	[no]	kW	single stage heat output and no room temperature control	[no]
In standby mode	$el_{sb}$	0,00061	kW	Two or more manual stages, no room temperature control	[no]
Model identifier(s): HPH01B-20E1W				with mechanic thermostat room temperature control	
Item	Symbol	Value	Unit	with electronic room temperature control	
<b>Heat output</b>				electronic room temperature control plus day timer	
Nominal heat output	$P_{nom}$	2,0	kW	electronic room temperature control plus week timer	
Minimum heat output (indicative)	$P_{min}$	2,0	kW	<b>Other control options (multiple selections possible)</b>	
Maximum continuous heat output	$P_{max,c}$	2,0	kW	room temperature control, with presence detection	[no]
<b>Auxiliary electricity consumption</b>				room temperature control, with open window detection	
At nominal heat output	$el_{max}$	[no]	kW	with distance control option	
At minimum heat output	$el_{min}$	[no]	kW	with adaptive start control	
In standby mode	$el_{sb}$	0,00061	kW	with working time limitation	
				with black bulb sensor	
Contact details	5-7 Bramley Business Park, Railsfield Rise, Leeds, LS13 3SA				

Electrorad U.K. Ltd  
5-7 Bramley Business Park,  
Railsfield Rise,  
Leeds,  
LS13 3SA

[www.electrorad.co.uk](http://www.electrorad.co.uk) T: 0113 2746799 E: [sales@electrorad.co.uk](mailto:sales@electrorad.co.uk)