

Drawings are for guide purposes only and may be subject to change at any time

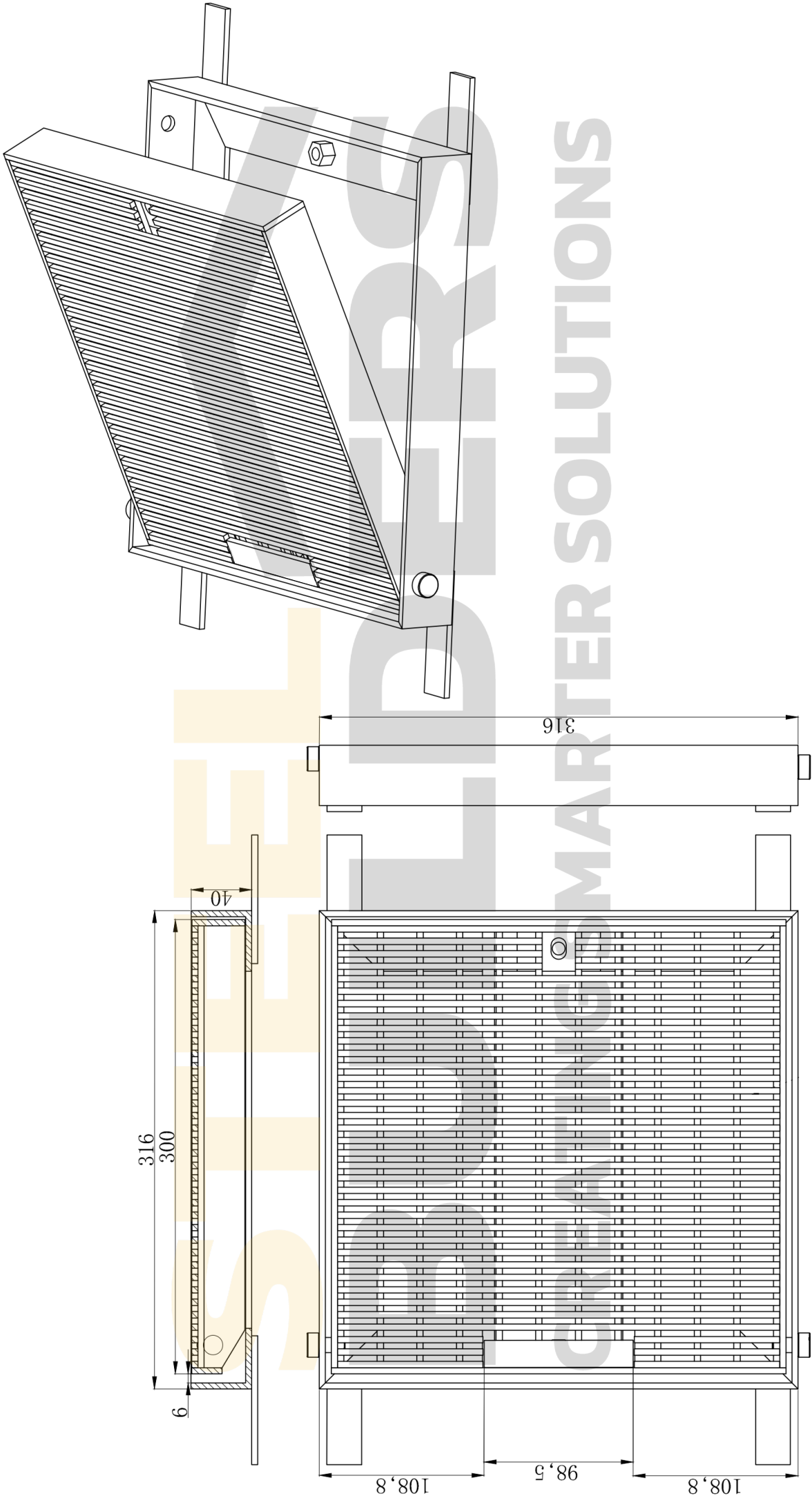

Drawings are for guide purposes only and may be subject to change at any time

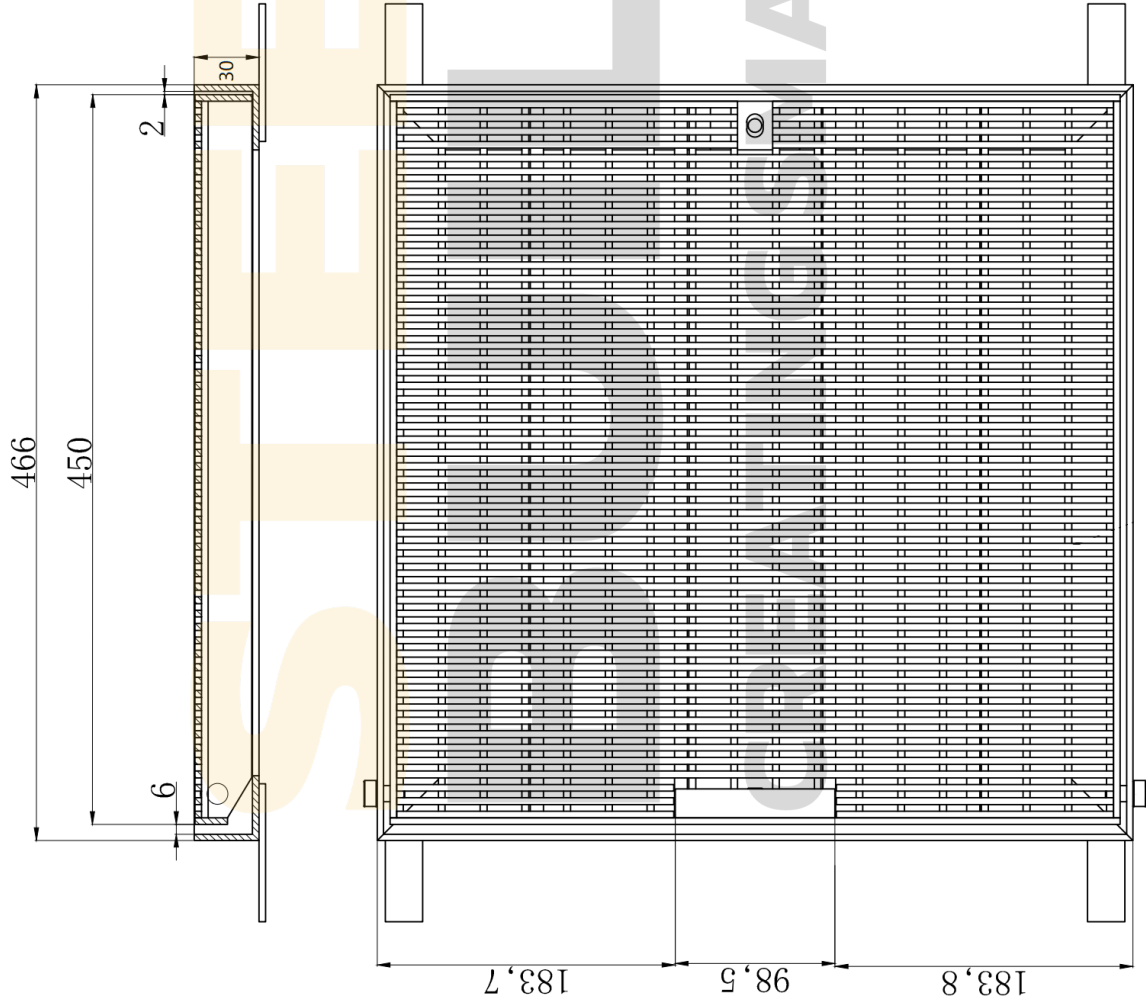
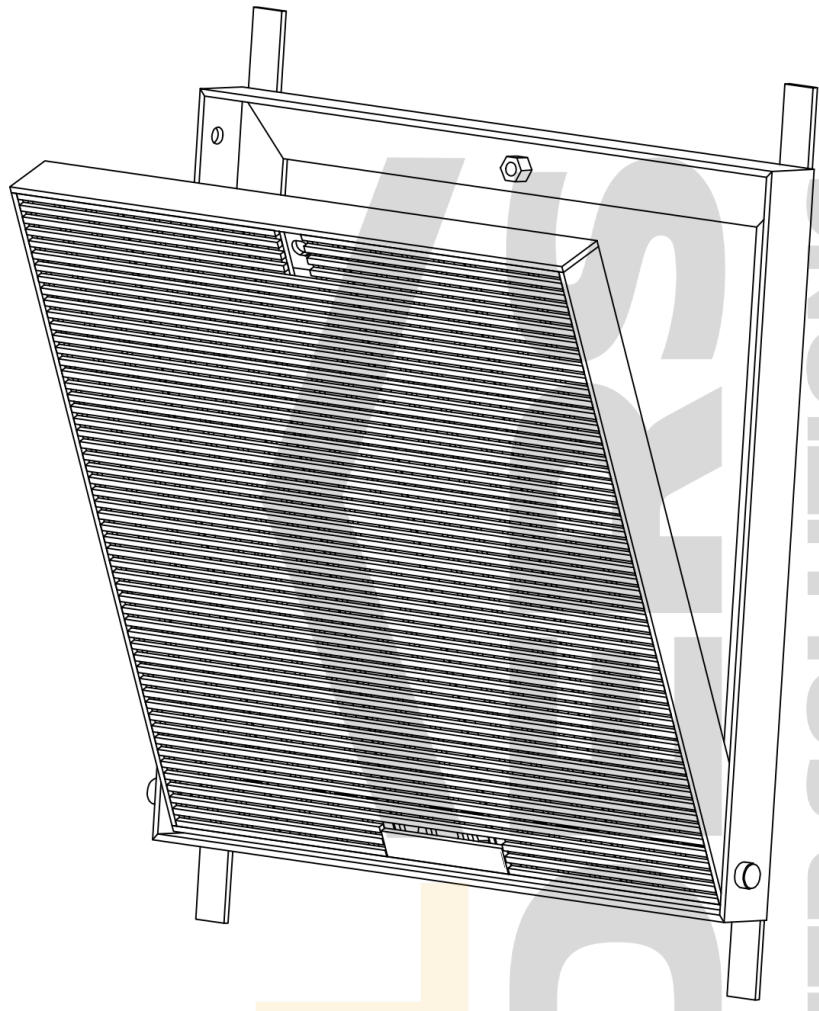

Drawings are for guide purposes only and may be subject to change at any time

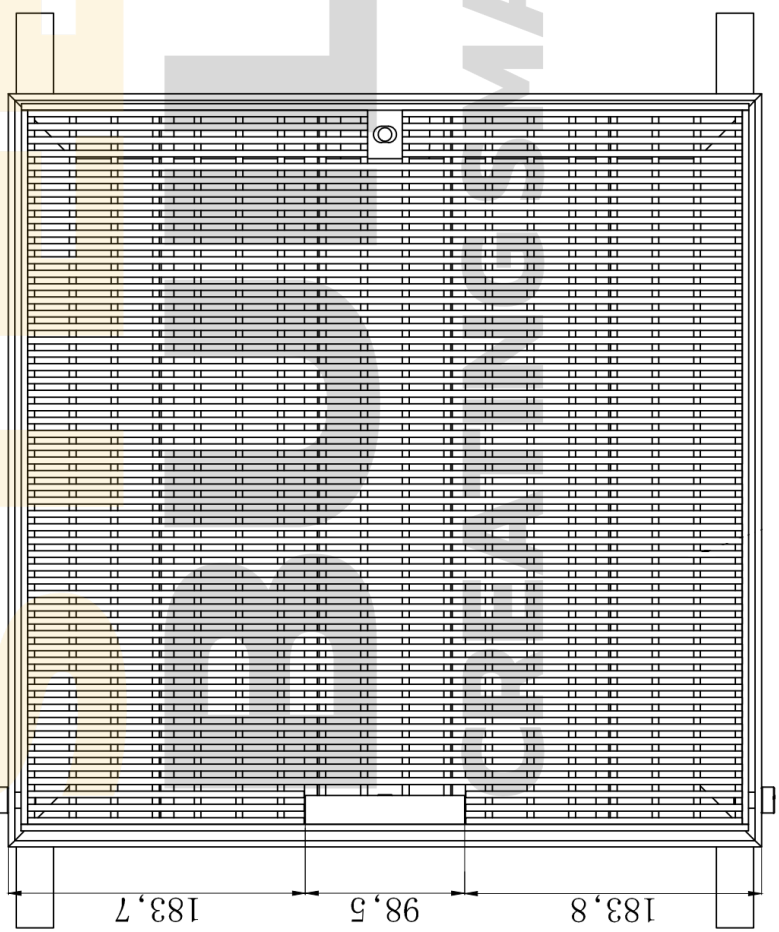
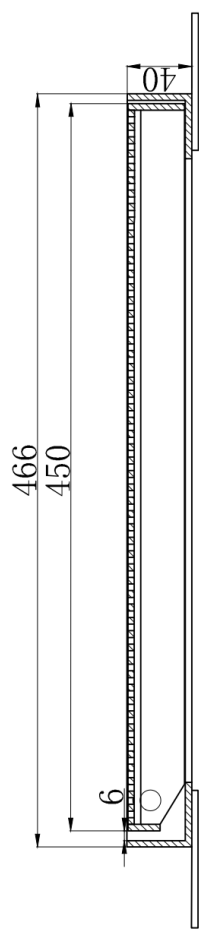
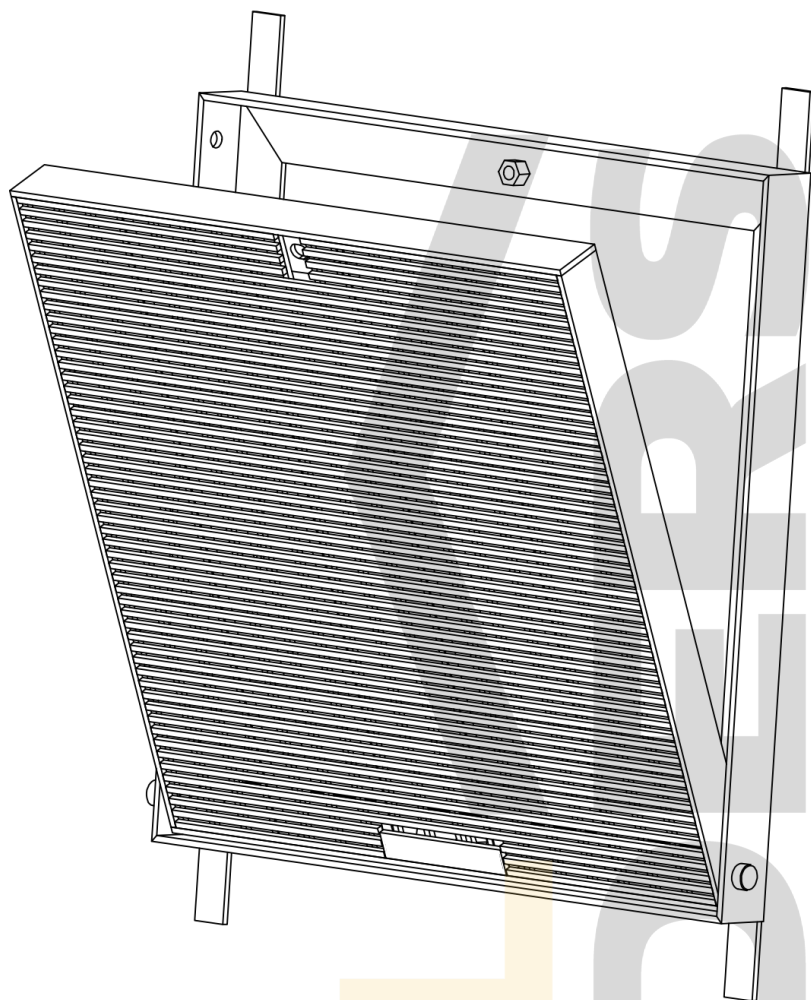

HEP  
PARTER SOLUTIONS

Drawings are for guide purposes only and may be subject to change at any time

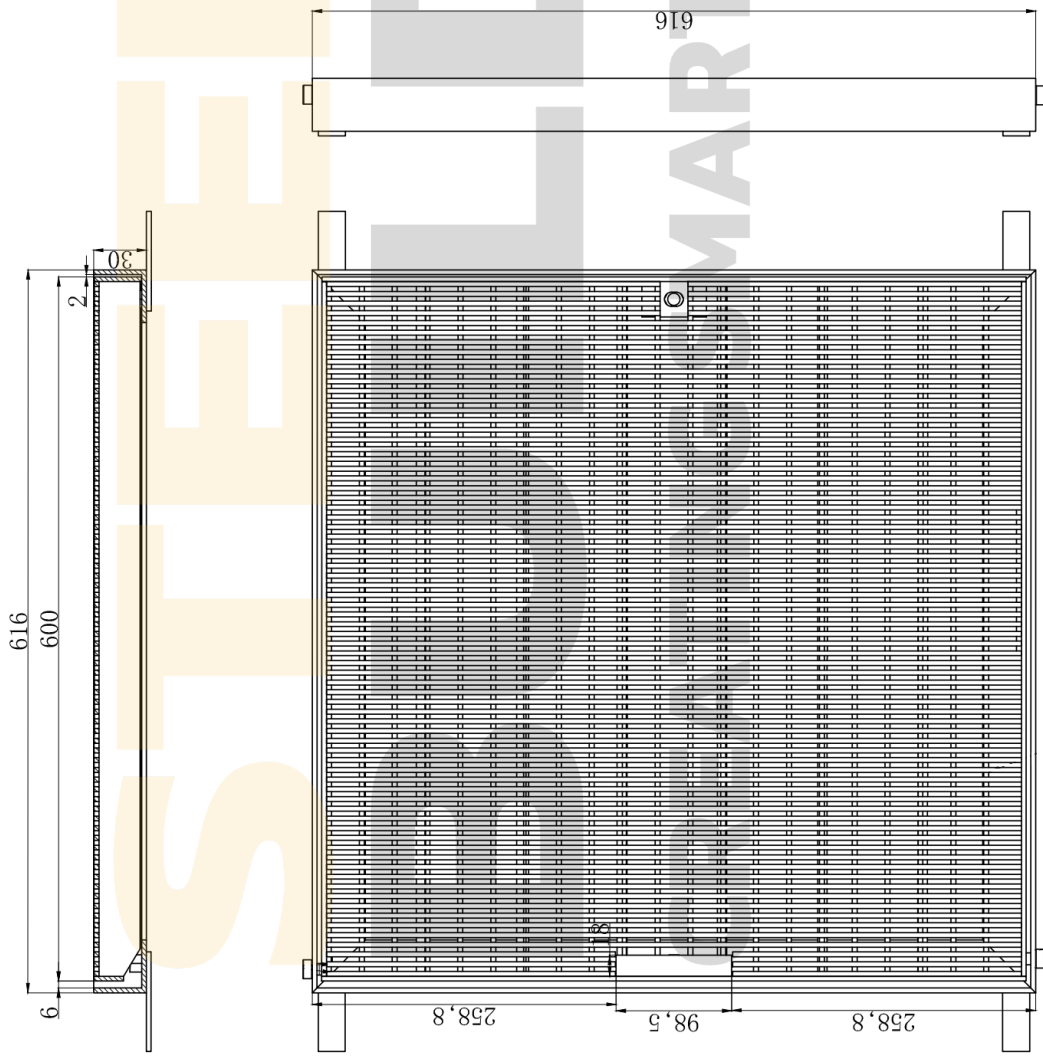
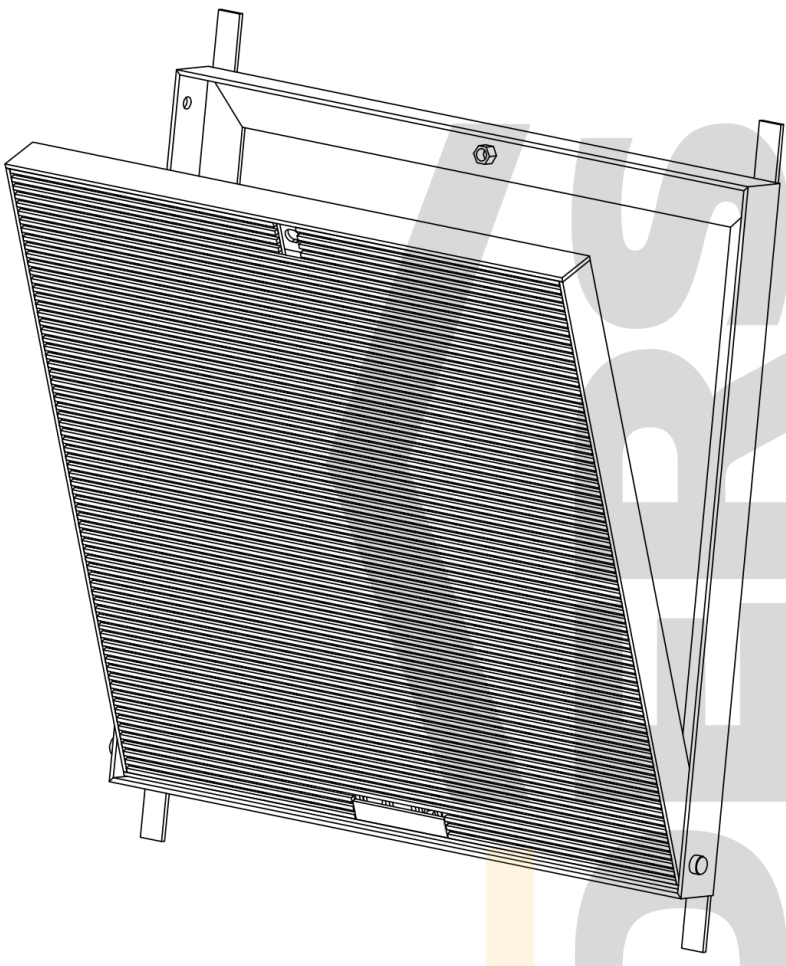

MARTER SOLUTIONS

Drawings are for guide purposes only and may be subject to change at any time

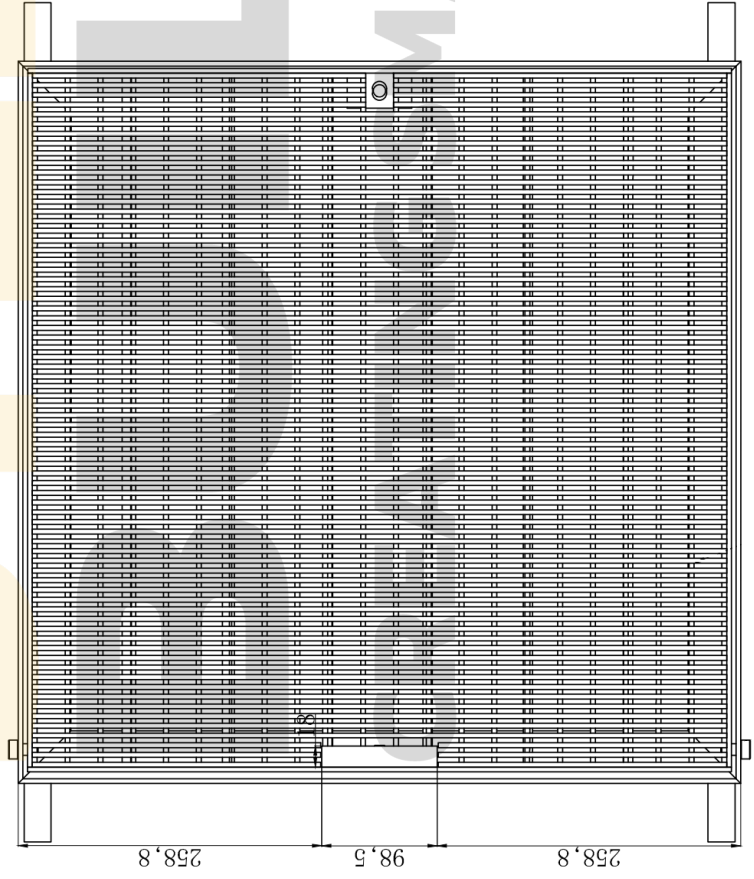
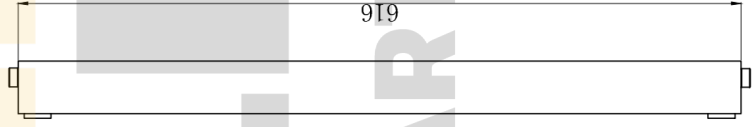
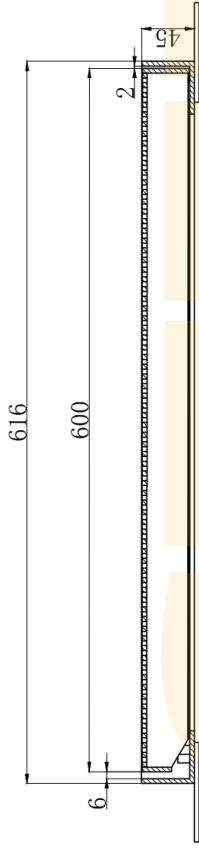
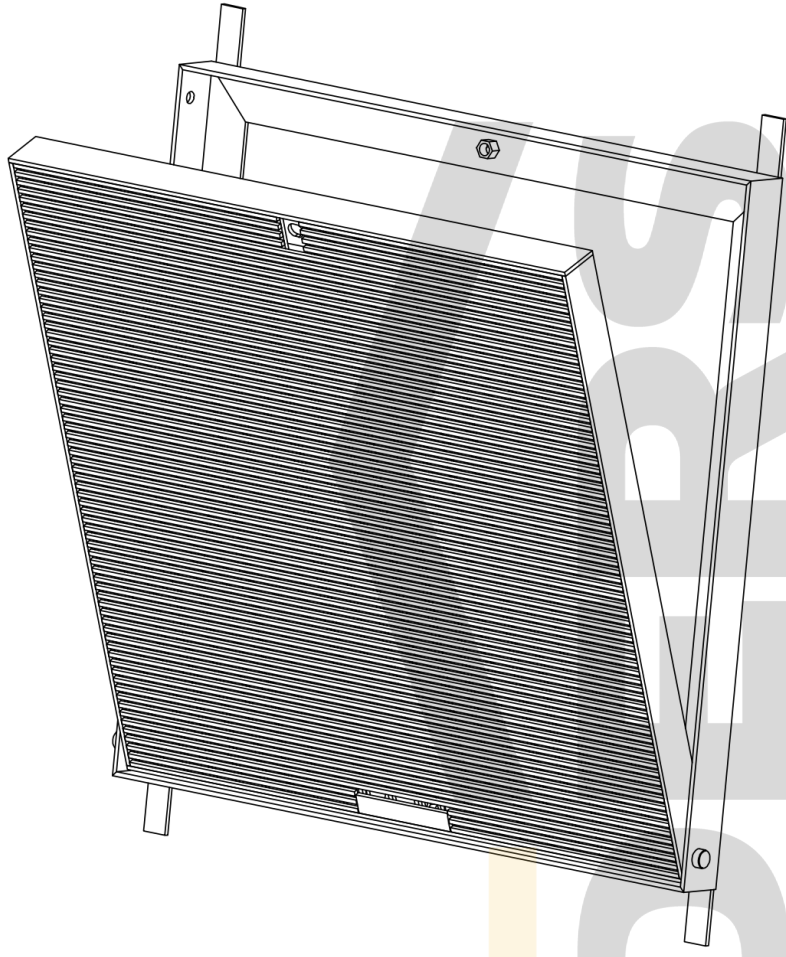

SMARTER SOLUTIONS

Drawings are for guide purposes only and may be subject to change at any time

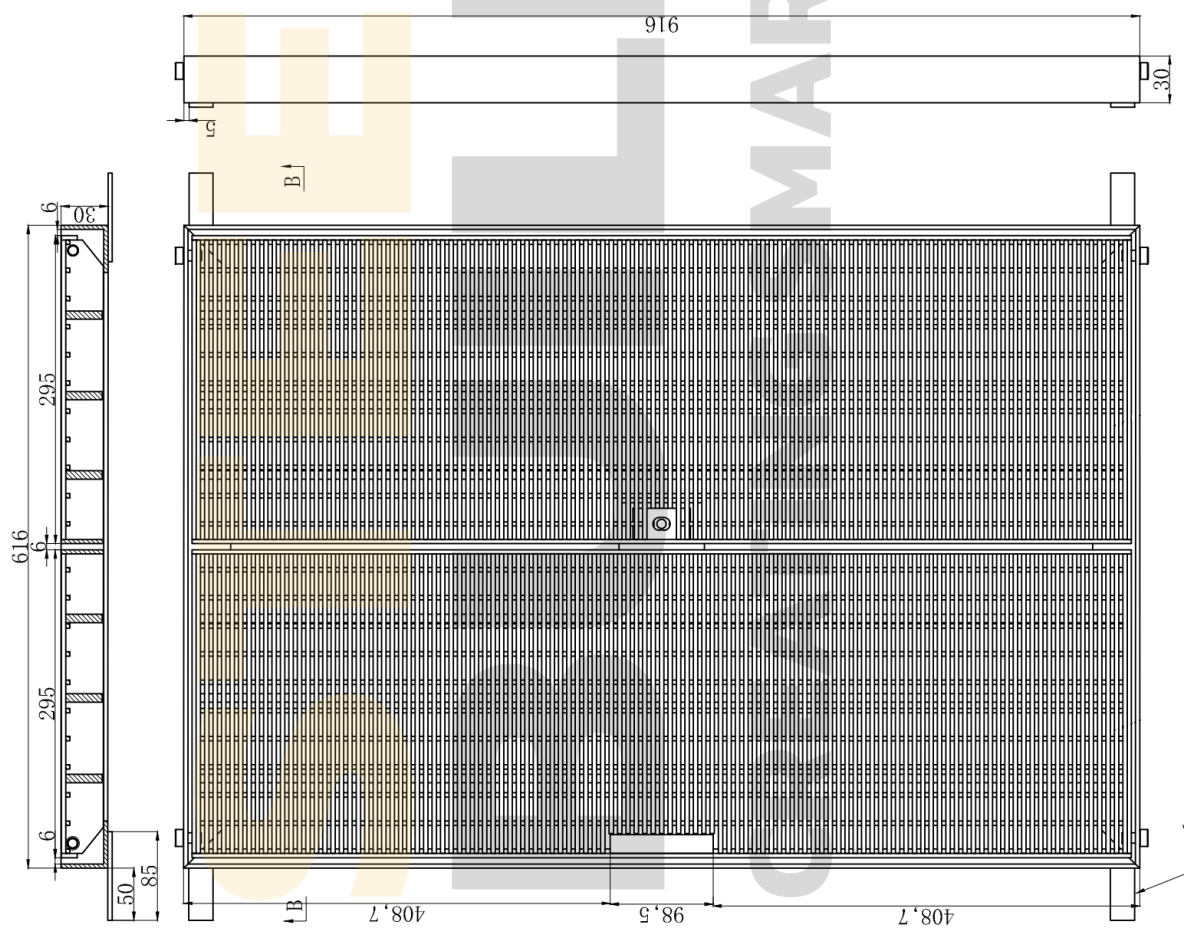
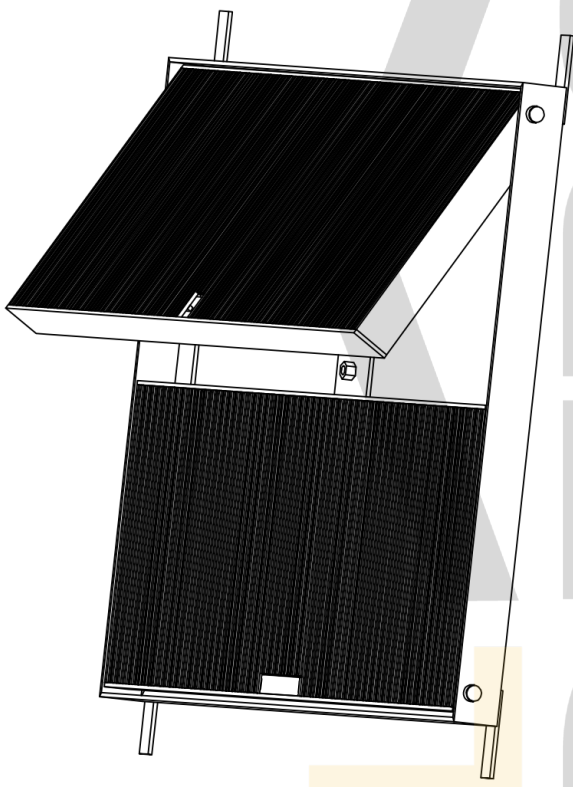

Drawings are for guide purposes only and may be subject to change at any time

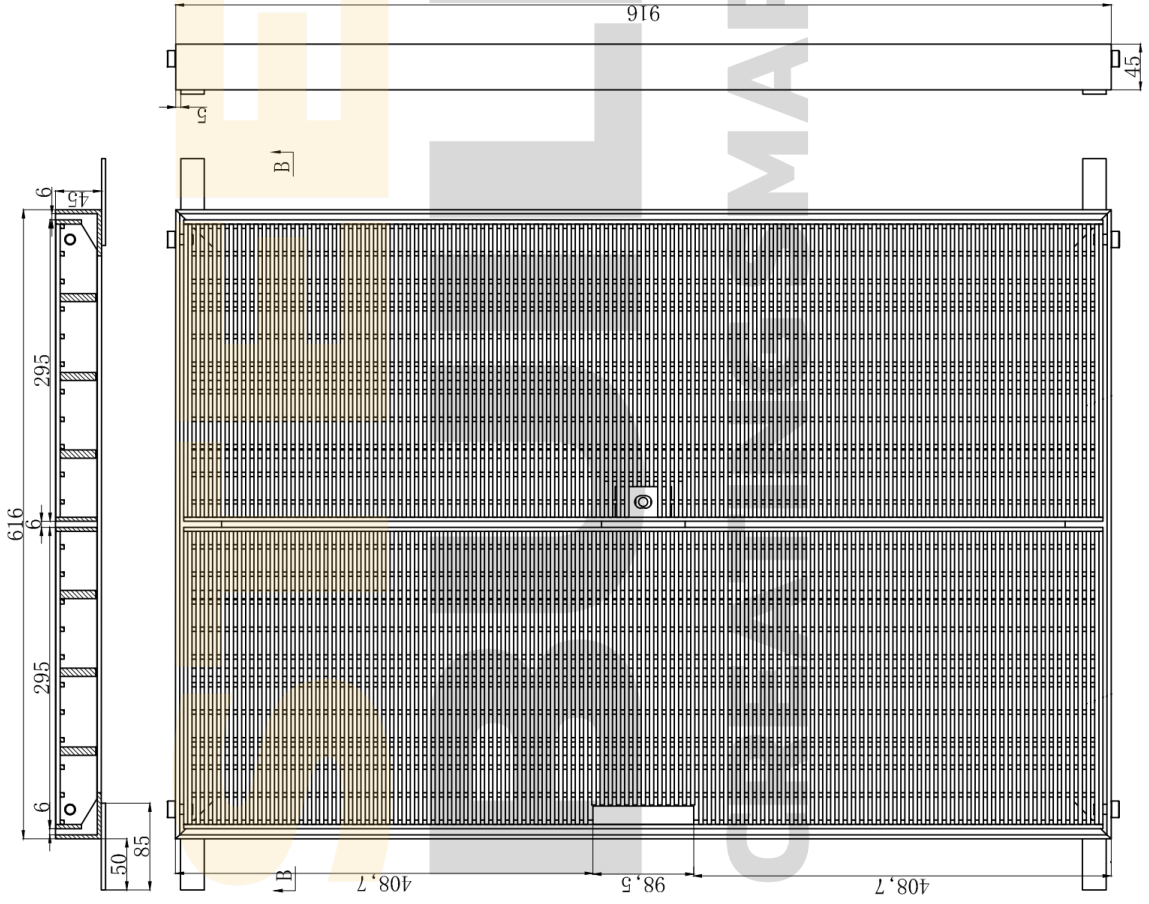
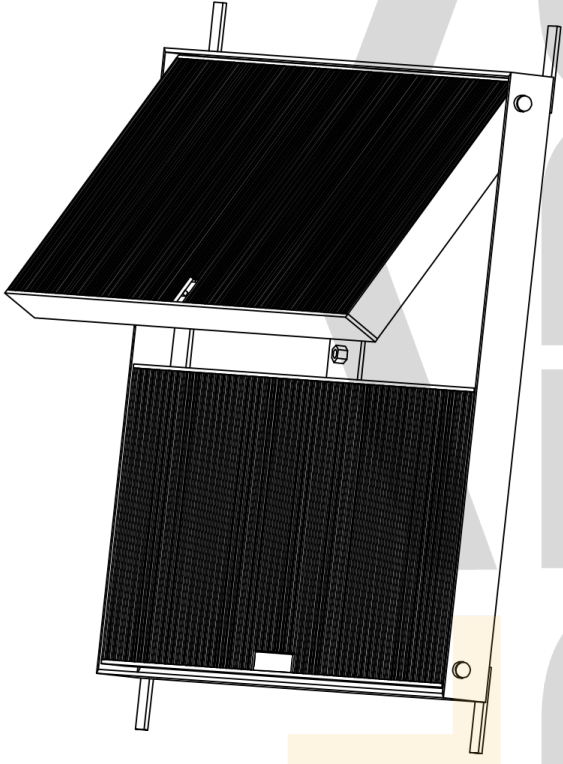

Drawings are for guide purposes only and may be subject to change at any time



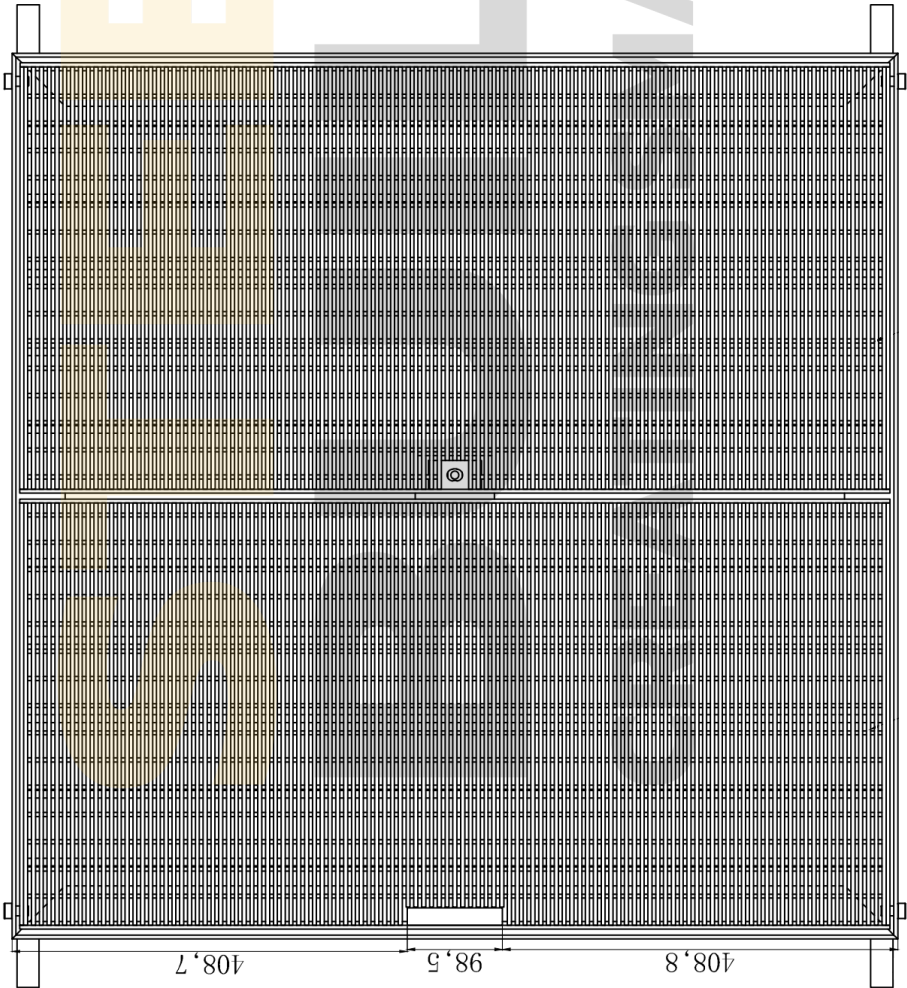
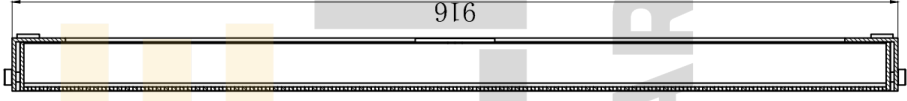
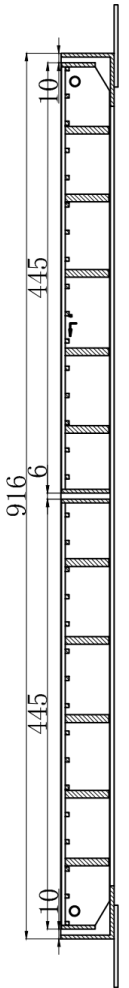
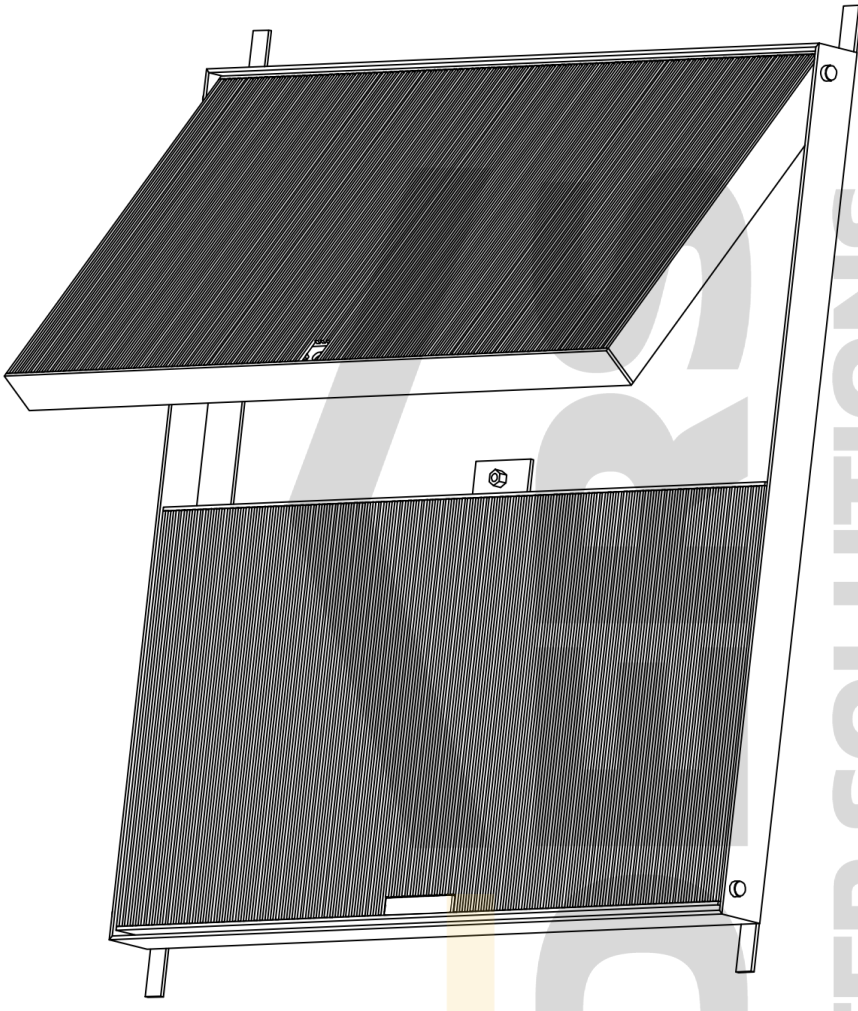

ARTER SOLUTIONS

Drawings are for guide purposes only and may be subject to change at any time

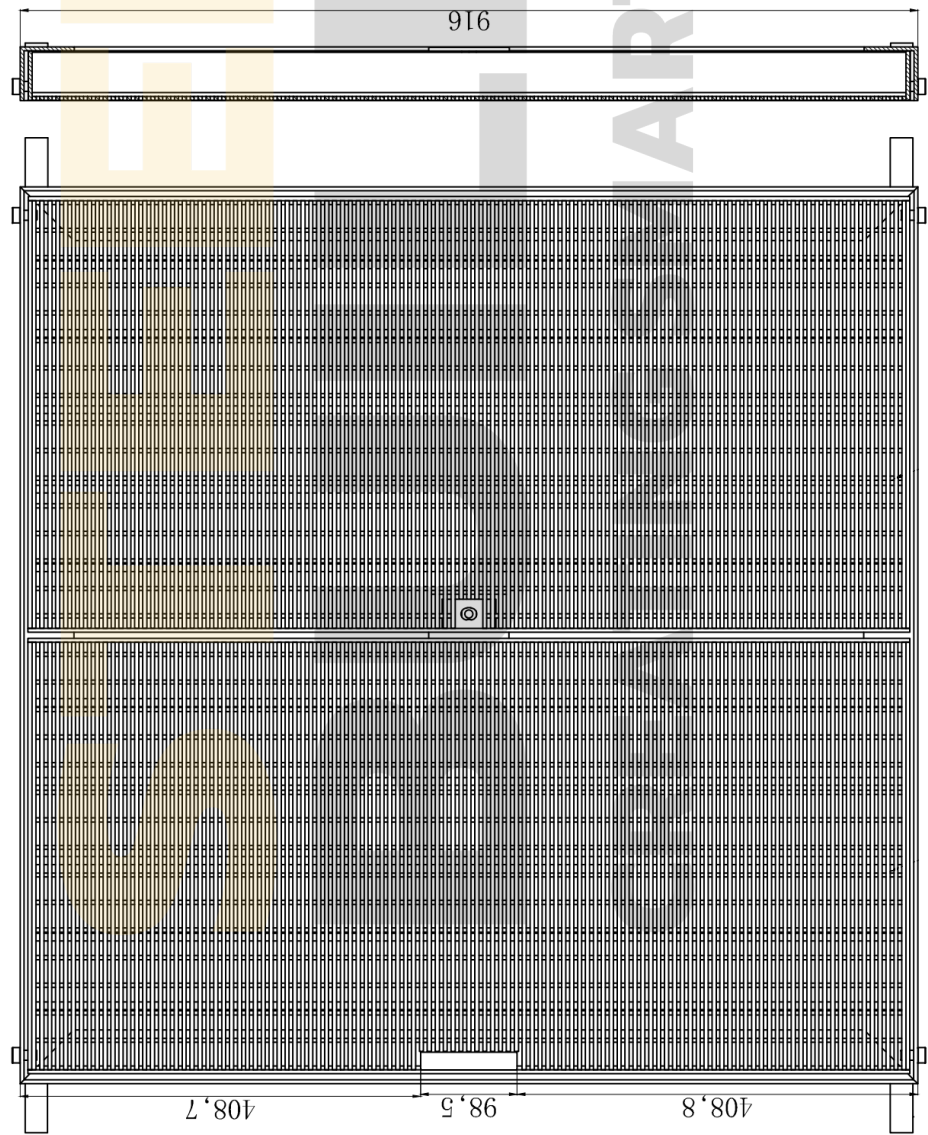
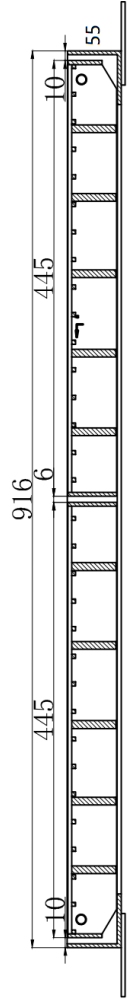
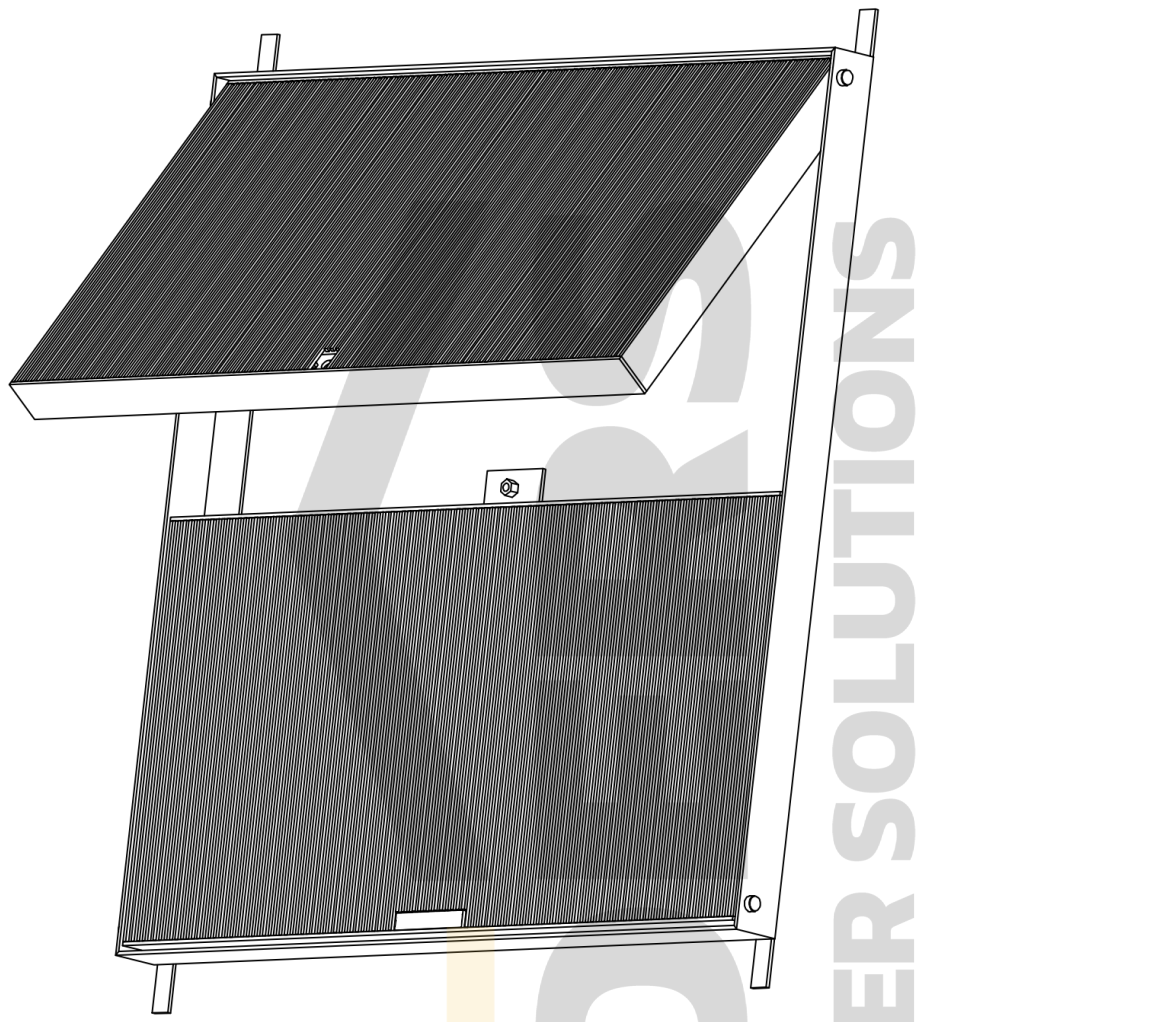

ARTER SOLUTIONS

Drawings are for guide purposes only and may be subject to change at any time

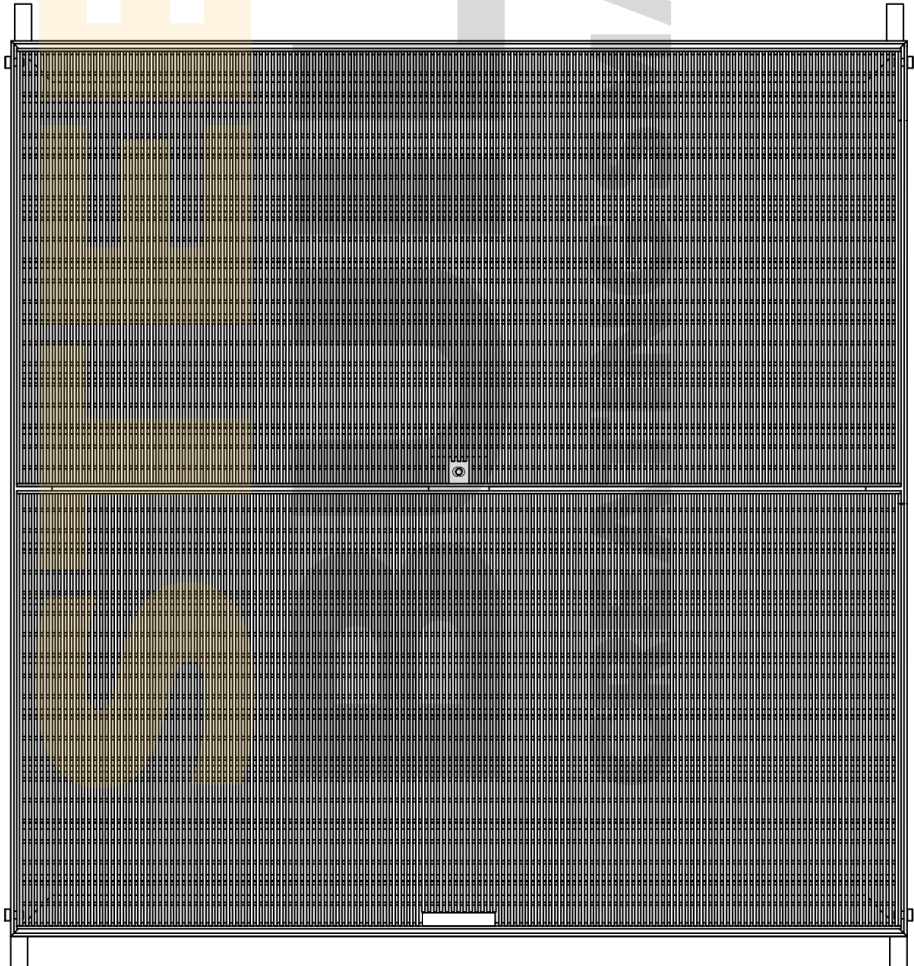
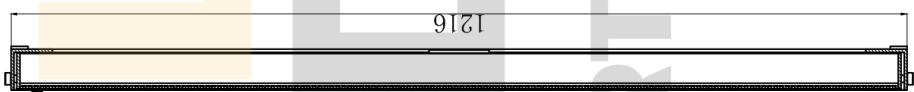
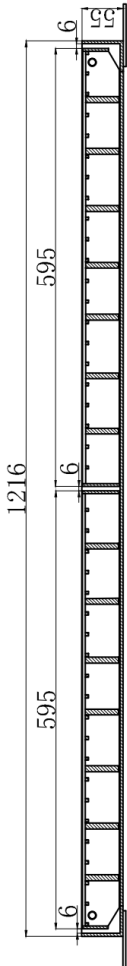
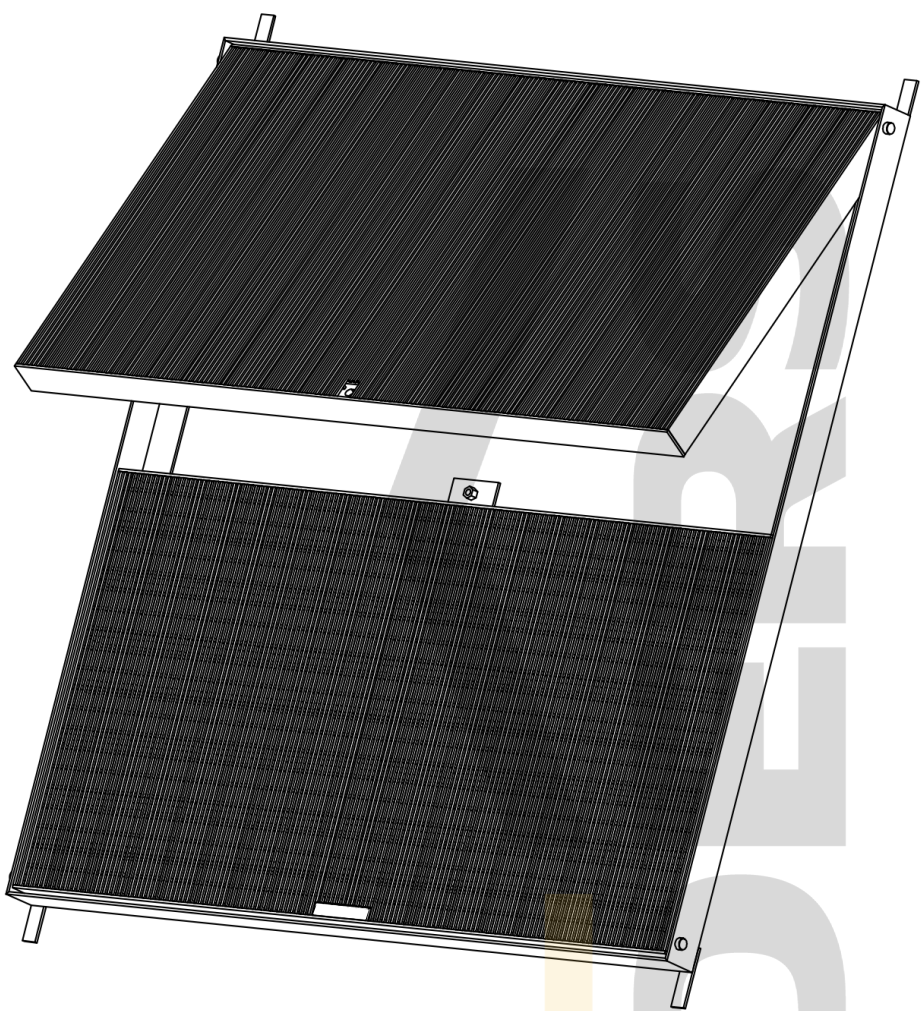

ARTER SOLUTIONS

Drawings are for guide purposes only and may be subject to change at any time