

PROJECT NAME	
ORDERING #	TYPE



DETAILS

Our Selectable LED UFO High Bay features high luminous efficacy combined with excellent build quality, a CRI of >80, and corrosion resistance. This corrosion-resistant light includes a hook for hanging. An adjustable U bracket and an adapter for pendant mounting are also available.

SPECIFICATIONS

Input Power	Wattage is selectable at install 150W Model: 150W/120W/100W 240W Model: 240W/200W/180W 310W Model: 310W/270W/240W
Input Voltage	120-277 VAC
Light Output	150W Model: Max. 22,500 lumens 240W Model: Max. 36,000 lumens 310W Model: Max. 46,500 lumens
Efficiency	150 lm/W
CCT	5000K
CRI	80
Average Lamp Life	50,000 hours
Dimming	0-10V with a dimming range of 100%-off
Controls	Includes plug for optional standard PIR sensor or PIR sensor with wireless networking for smart lighting control
Beam Angle	120°
Operating Temperature	-40°F to 122°F
Housing Color	Black
Certification	DLC, UL
Warranty	5 Years



150W



240W







310W

ORDERING

Example: **HBFXB150WSUD50**

SKU Root	Housing Color	Wattage / Lumens	Certification	CCT
HBFX	B - Black	150WS - 150W/120W/100W, Up to 22,500 lm 240WS - 240W/200W/180W, Up to 36,000 lm 310WS - 310W/270W/240W, Up to 46,500 lm	UD - DLC, UL	50 - 5000K

ACCESSORIES

Item Type	SKU	Description	Image
Sensor	ACCXHBFXSENSOR	PIR sensor (without receptacle of sensor)	
Remote	ACCXHBFXREMOTE	Remote Controller	
Mount	ACCXHBFXUBRKTSM ACCXHBFXUBRKTG	U bracket -A, black - Small U bracket -C black - Large	
Battery	EMUFO-25170-YY EMUFO-40170-YY	Emergency Battery Backup -25W/90min Emergency Battery Backup -40W/90min	

DIMENSIONS

150W

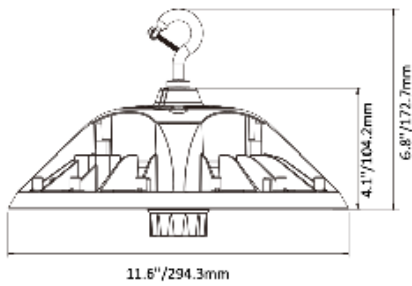

240W

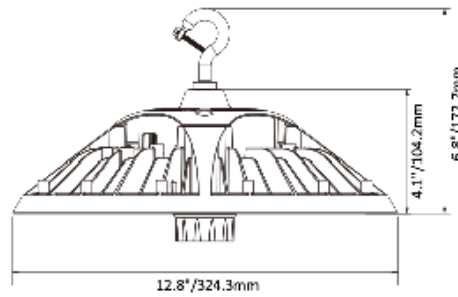

310W

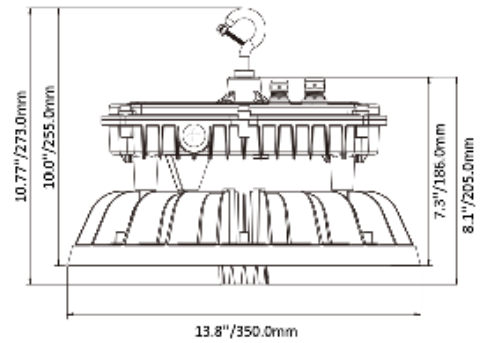

PHOTOMETRICS

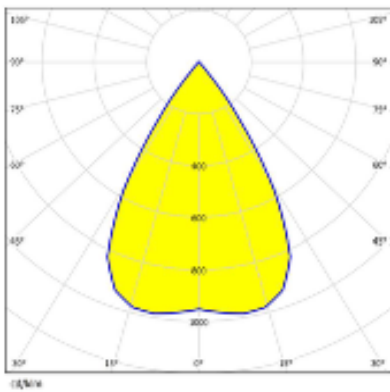

Beam angle: 60°

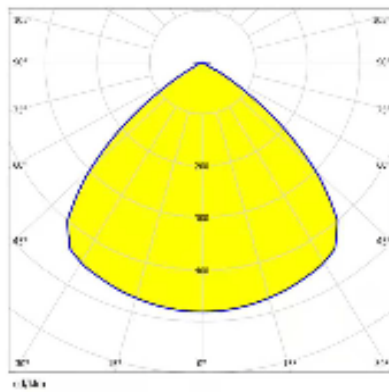

Beam angle: 90°

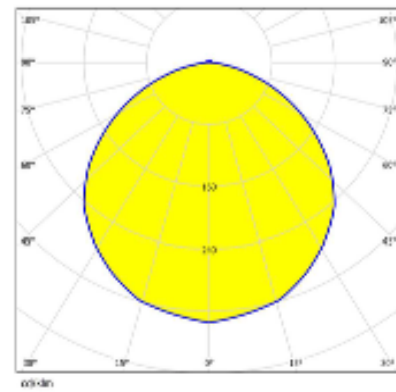

Beam angle: 120°