

Project Name: \_\_\_\_\_

Ordering #: \_\_\_\_\_ Type: \_\_\_\_\_



**5** YEAR WARRANTY

### OVERVIEW

<b>Wattage (W)</b>	100W, 150W, 250W, 300W
<b>Lumen Package (lm)</b>	Up to 42,000 lm
<b>Color Temperature (CCT)</b>	5000K
<b>Efficacy (lm/W)</b>	140 lm/W



100W



150W



250W, 300W

### SPECIFICATIONS

<b>Wattage &amp; Lumens</b>	100W, 14,100 lumens 150W, 21,000 lumens 250W, 35,000 lumens 300W, 42,000 lumens
<b>Efficacy</b>	140 lm/W
<b>CCT</b>	5000K
<b>CRI (Ra)</b>	70
<b>Controls</b>	0-10V Dimming
<b>Input Voltage</b>	120-277VAC, 347-480VAC
<b>Average Lifetime</b>	100,000 hours
<b>Beam Angle</b>	T3 (pushes light forward)
<b>Mounting</b>	Pole Mount, Slipfitter, Yoke Mount, Wall Mount
<b>Material</b>	Aluminum Alloy Polycarbonate Optical Lens
<b>IP Rating</b>	IP65
<b>Certifications</b>	UL
<b>Warranty</b>	5 Years

### ORDERING GUIDE

Example: **SBM5T3D100UD50**

SKU Root	Beam Angle	Controls	Wattage / Lumens	Certification	CCT
<b>SBM5</b>	<b>T3</b>	<b>D</b> - Dimmable	<b>100</b> - 100W, 14,100 lumens <b>150</b> - 150W, 21,000 lumens <b>250</b> - 250W, 35,000 lumens <b>300</b> - 300W, 42,000 lumens	<b>UD</b> - UL	<b>50</b> - 5000K

**PRODUCT DIMENSIONS**

**100W (Slipfitter Mount)**

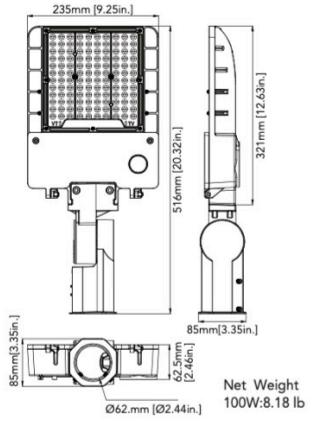

**100W (Wall Mount)**

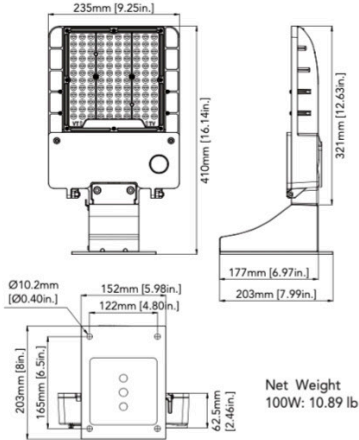

**100W (Pole Mount)**

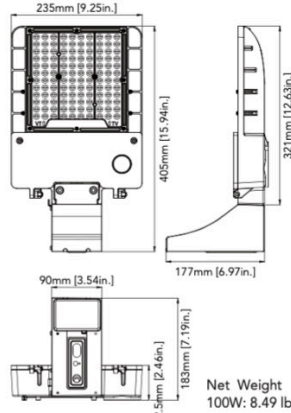

**100W (Yoke Mount)**

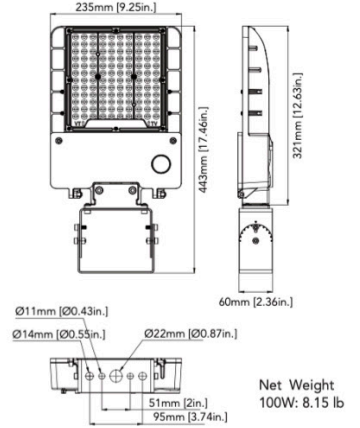

**150W (Slipfitter Mount)**

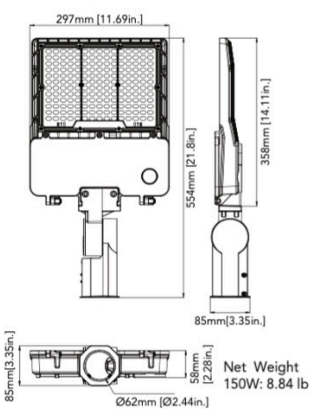

**150W (Wall Mount)**

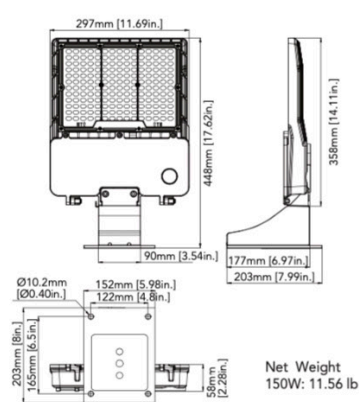

**150W (Pole Mount)**

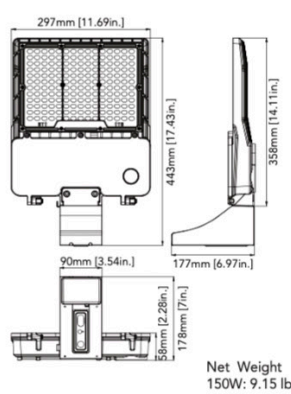

**150W (Yoke Mount)**

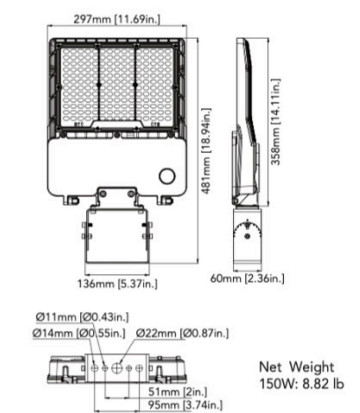

**250W/300W (Slipfitter Mount)**

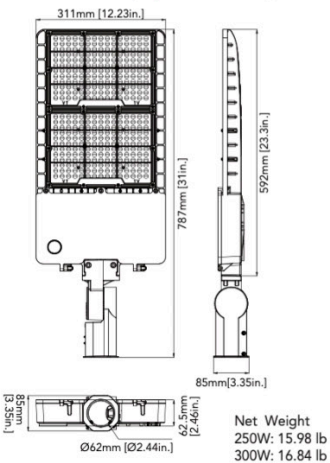

**250W/300W (Wall Mount)**

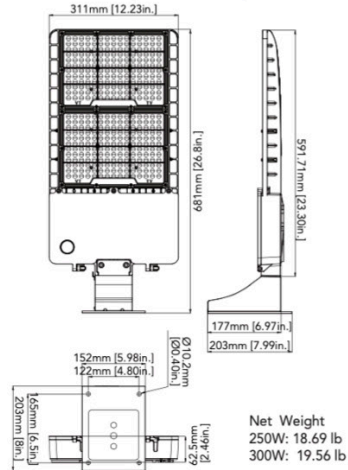



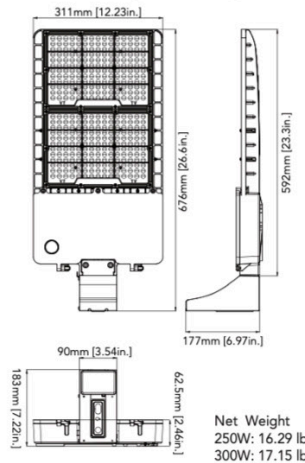

**250W/300W (Pole Mount)**

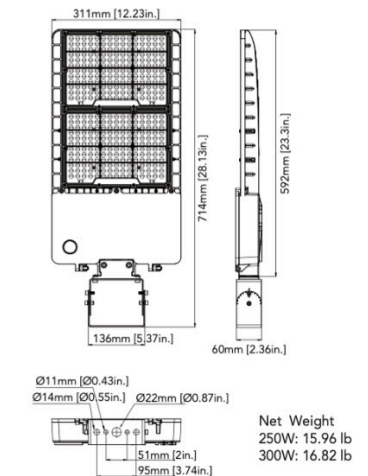





**250W/300W (Yoke Mount)**

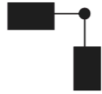

**ACCESSORIES**

SKU	Description	Image
SBM5SLIPFITTER	Slipfitter Mount	
SBM5YOKEMOUNT	Yoke Mount	
SBM5WALLMOUNT	Wall Mount	
SBSG4PHOTOCELL	Photocell	
SBM5POLEMOUNT	Pole Mount	

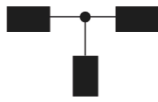
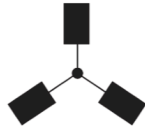
**EPA RATINGS FOR POLE MOUNTING**

Item							
	1	2 @90°	2 @120°	2@180°	3 @90°	3 @120°	4 @90°
100W	0.2751	0.5267	0.7321	0.6164	0.9577	0.9837	0.9577
150W	0.3111	0.6343	0.6464	0.6222	0.9335	0.9696	0.9335
250W/300W	0.4097	0.7227	0.9919	0.8856	1.1986	1.3049	1.1986