

plano **ARCH**

# LPVT | Luxmark

Product Data Sheet

**PRO+**



**COMMERCIAL-GRADE**

**Center-Basket Troffer | PRO+ Premium**

1x4 | 2x2 | 2x4



## Product Overview

The LPVT Luxmark-series is the perfect solution for all your office lighting needs. With its modern architectural grade design, integrated switches, and seamless light distribution, the Luxmark is sure to impress.

Backed by a 7-year warranty and tested to meet the highest standards of quality, the Luxmark is engineered for easy installation and maintenance. It comes with all the necessary hardware and instructions, and it can be installed in minutes.

The Luxmark has been tested by independent laboratories in accordance to IESNA LM79 and LM80. LED color temperature is warranted to shift no more than 180K over the standard warranty period. Furthermore, the range of Correlated Color Temperature follows the guidelines of the American National Standard for Specifications for the Chromaticity of Solid State Lighting (SSL) Products, ANSI C78.377-2017.

## Product Warranty\*



7-Year Warranty



75,000 Hrs

\* Standard warranty. Extended warranty available.

## Applications



Office Spaces



Schools



Commercial Spaces



General Lighting

## Main Features

- **Polycarbonate Frame** For Durability And Safety
- **Steel Housing With Heat-Resistant Frosted Lens** For Long-Lasting Performance In Demanding Environments.
- Choose From **4-Way Selectable Wattages And 0-10V** Dimmability To Create The Perfect Lighting Atmosphere For Any Space.
- Available In **4-Way Selectable CCT** Through Driver-Based Dip-Switches To Match Lighting To The Space.
- **Easy Installation** With Standard Lay-In Or Surface Mount Options.
- **Architectural Design** Is Suitable For Any Office Or Commercial Spaces.
- **Microchip Programmed Light-Engine** For Consistent Color Temperature.
- High-Density LED Chips For **Uniform Light Output**.
- Backed By A **7-Year,75,000 Hour Warranty**.
- **ETL Damp Location** Listed For Use In Damp Locations.
- **DLC Premium** Listed.

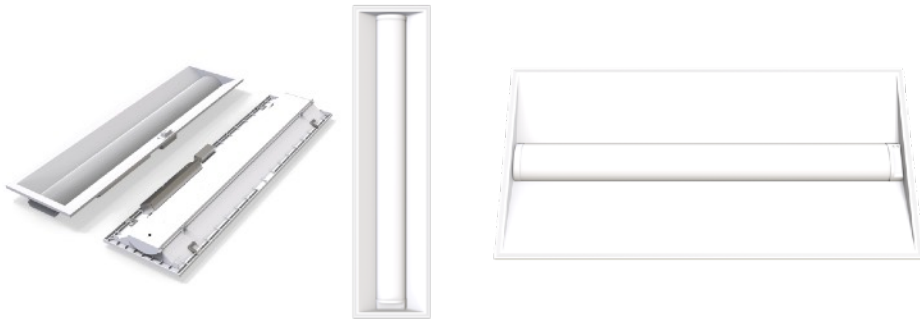

## Project Details

Project Name:

Fixture Schedule:

Project Number:

Notes:

## Highlights

Features	Description
----------	-------------

4-WATTselect	 Wattage selectable: 4-way dip-switch
--------------	--

4-CCTselect	 CCT selectable: 4-way dip-switch
-------------	--

PRO+ Premium Solution	 Everything you would want
-----------------------	---

Limited Warranty	 7-Year Warranty
------------------	---

























## Key Specifications

- **Frame:** Polycarbonate
- **Housing:** Cold-Rolled Steel
- **Dimming Status:** Continuous Dimming <10%
- **Operating Temp:** 32°F – 104°F
- **IP:** IP20 Indoor Damp Location
- **Input Voltage:** 120-277V
- **PF:** > 0.9 Non-Flicker
- **Efficacy:** 125LM/W
- **Dimming:** 0-10V
- **THD:** <15%
- **CRI:** >80

## Certifications



## Model Specifications

Model Series	Dimensions	4-WATTselect	4-CCTselect	Max Lumen	LPW
LPVT22	2x2	20W  25W  30W  35W 	3000K  3500K  4000K  5000K 	4375lm	125lm/W
LPVT14	1x4	35W  40W  45W  50W 	3000K  3500K  4000K  5000K 	6250lm	125lm/W
LPVT24	2x4	35W  40W  45W  50W 	3000K  3500K  4000K  5000K 	6250lm	125lm/W

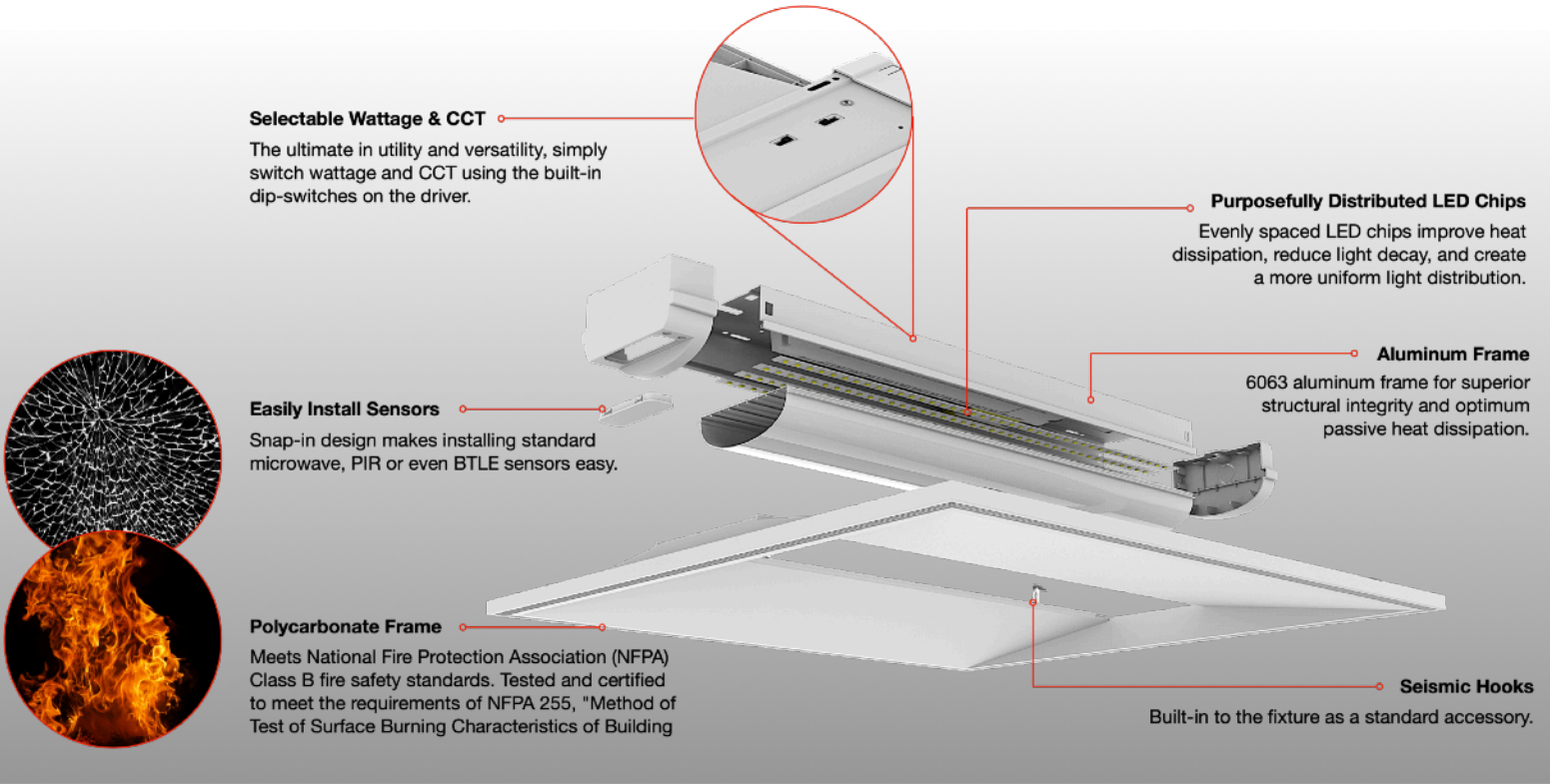

## Ordering Guide

Model Series	Size (FT)	WATTselect (W)	CCTselect (K)
<b>LPVT</b> Center-Basket Troffer	<b>22</b>   2x2	<b>-2035:</b> 20W / 25W / 30W / 35W	<b>CS</b>   CCTselect: 3000K / 3500K / 4000K / 5000K /
	<b>14</b>   1x4	<b>-3550:</b> 35W / 40W / 45W / 50W	
	<b>24</b>   2x4		

Note: Default settings are displayed in GRAY. Spec selections and optional accessories are displayed in RED.

### Optional Accessories

(1) EM Driver	(2) Sensors	(3) Step-Down Transformer	(4) Flange Kit	(5) Surface Mount	(6) Suspension Kit
<b>/EM08</b>   EM08-MT/150	<b>/BLS</b>   Bi-Level Sensor <b>/NLC</b>   NLC Compliant	<b>/325</b>   SDT-HTI/325	<b>/F14</b>   1x4 <b>/F22</b>   2x2 <b>/F24</b>   2x4	<b>/S14</b>   1x4 <b>/S22</b>   2x2 <b>/S24</b>   2x4	<b>/SUSPN14</b>   1x4 <b>/SUSPN22</b>   2x2 <b>/SUSPN24</b>   2x4

Ordering number example:

Choose your model specifications:

LPVT <b>22-2035CS/EM08/NLC</b>	LPVT	<b>22</b>	<b>-2035</b>	CS	<b>/EM08</b>	<b>/NLC</b>
--------------------------------	------	-----------	--------------	----	--------------	-------------

Please place dashes (-) in correct order.

Model Series

Size

WATTselect

CCTselect

(1) EM

(2) Sensor



## Versatile Design



Front view



Exploded view



Backside

blueARCH → enABLED

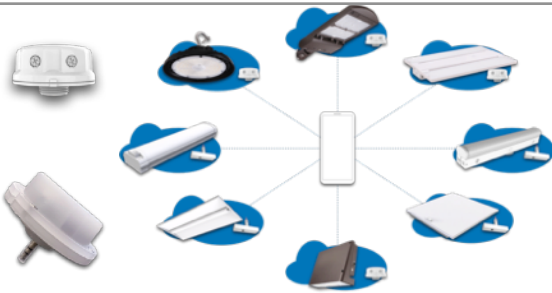

SIG-qualified Bluetooth Mesh lighting control solution. Technology by SILVAIR.

## Photometric

1 x 4 | 25W

Luminous Distribution

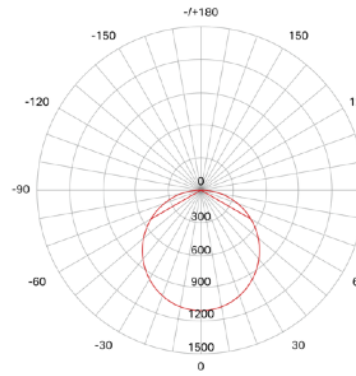

Isocandela Diagram

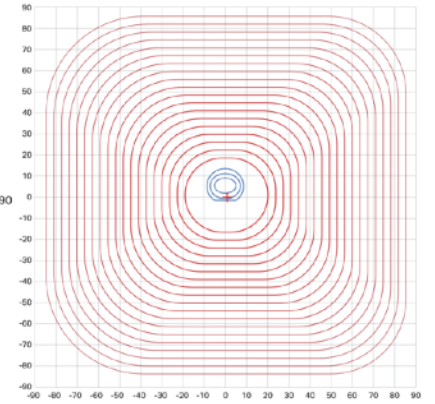

2 x 2 | 25W

Luminous Distribution

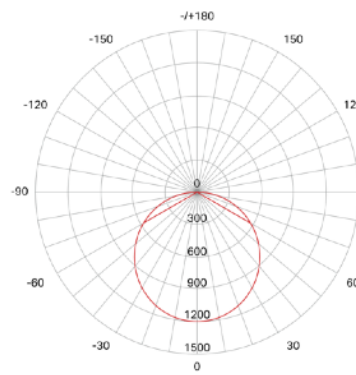

Isocandela Diagram

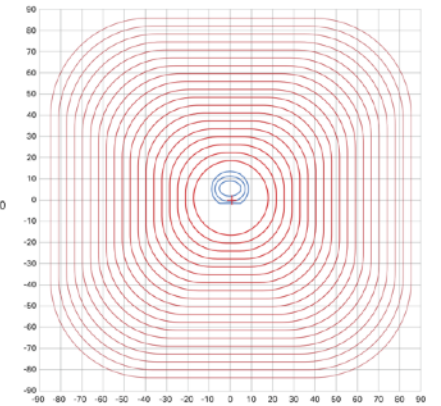

2 x 4 | 40W



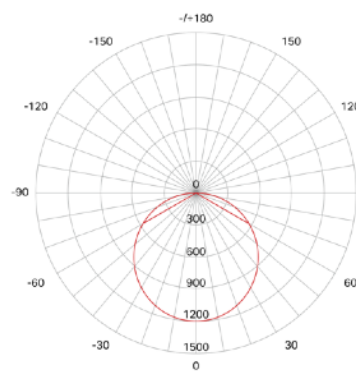



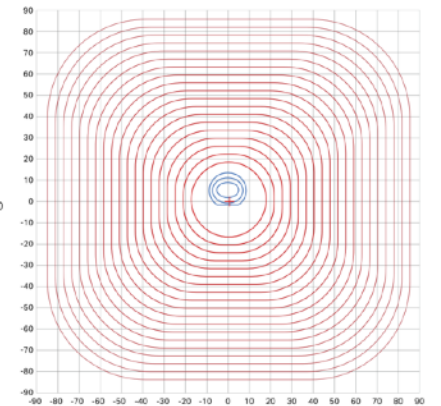

Luminous Distribution



Isocandela Diagram



## Compatible Accessories

Category	Model No.			Sub-Assembly & Compatible Controllers
480V Stepdown Transformer		SDT-HTI/325		
EM Driver		EM08-MT/150		
Mount / Flange Kit		plano-M/F14	plano-M/F22	plano-M/F24
Mount / Surface Kit		plano-M/S14	plano-M/S22	plano-M/S24
Mount / Suspension Kit		SUSPN14	SUSPN22	SUSPN24
Sensor / NLC Compliant		MSM-HTI/08/NLC		blueARCH™ Controls Technology by SILVAIR 
Sensor / Bi-Level Sensor		MSM-HTI/08/BLS		RM-HT/05S Controller 