

# LED Flood Light

## Installation Instructions

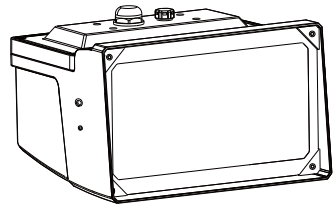

Single Module

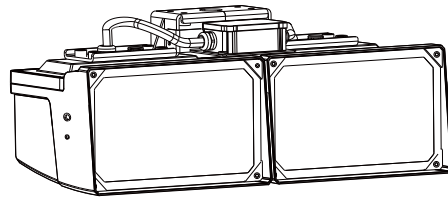

Double Module



## Physical Dimensions(Unit: mm/inch)

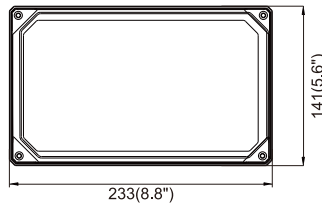
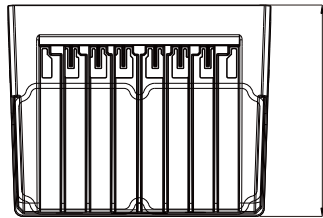

Single module

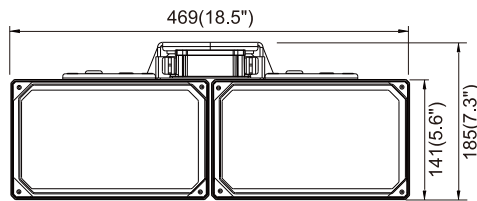
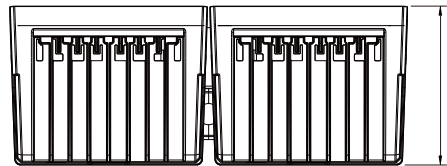

Double module

## CCT + Power Selectable

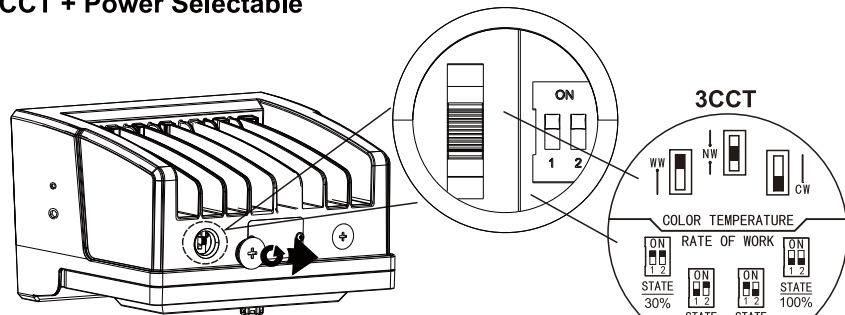

## Slipfitter Mount(Unit: mm/inch)

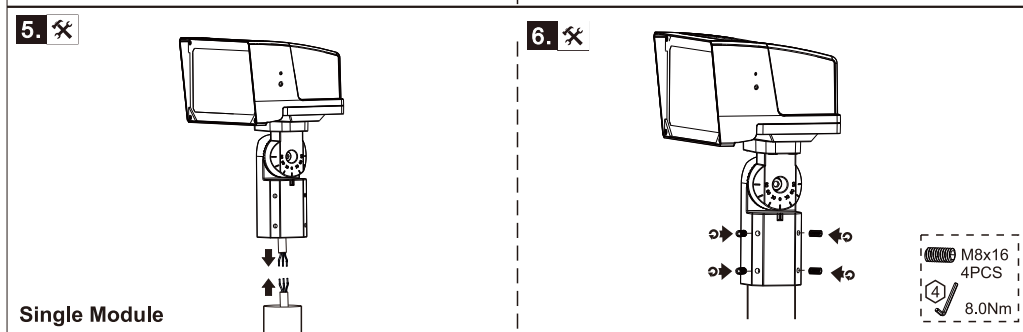
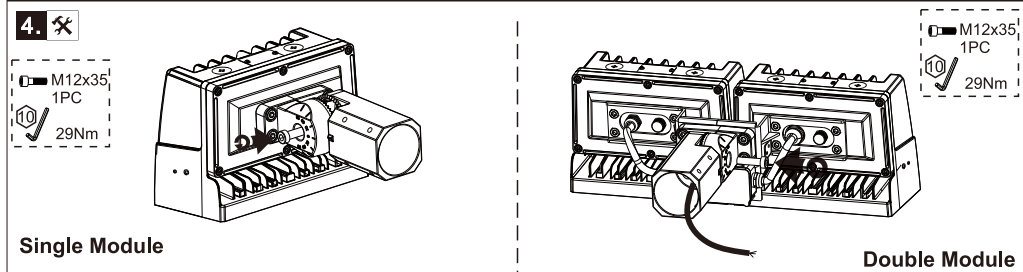
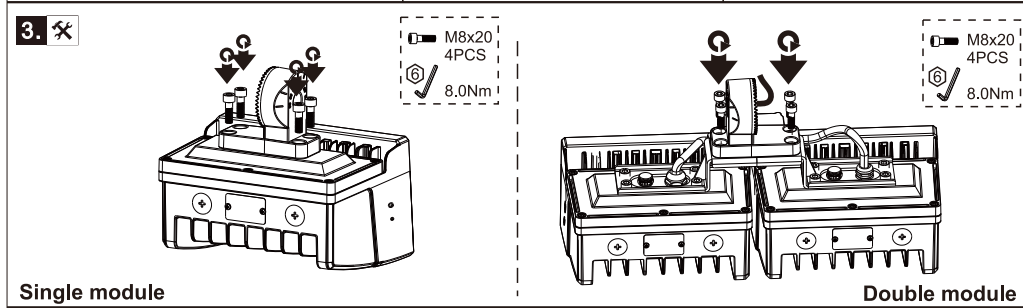
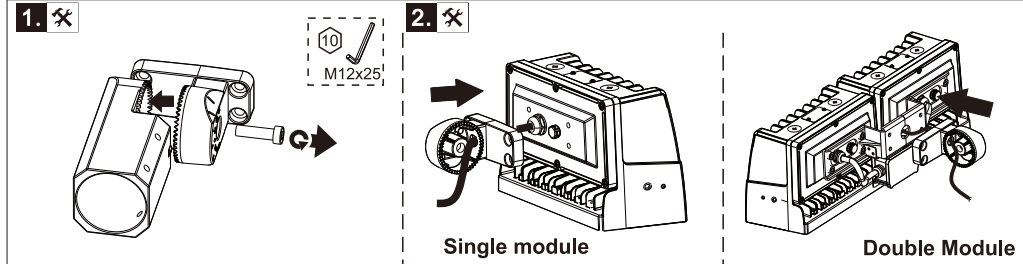
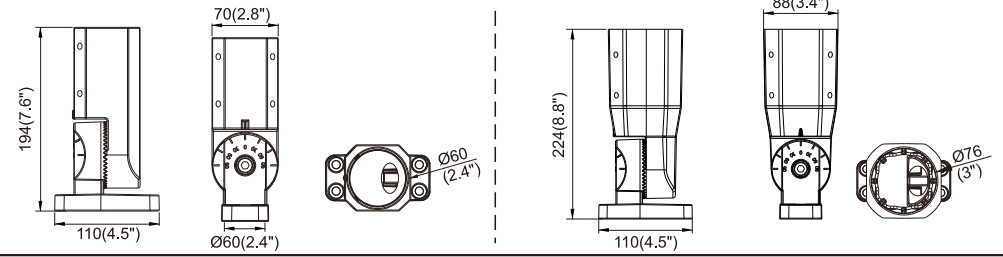

### Double Module

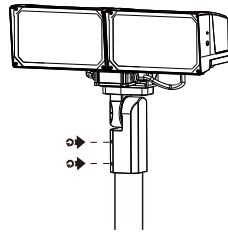
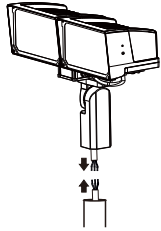

M8x16  
4PCS  
8.0Nm

### Yoke Mount(Unit: mm/inch)

#### Single Module

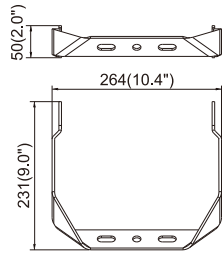

#### Double Module

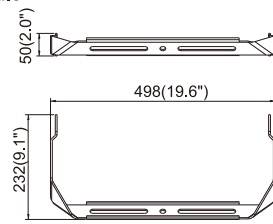

### 1. Single Module

M8x20  
2PCS  
8.0Nm  
M5x12  
2PCS  
2.0Nm

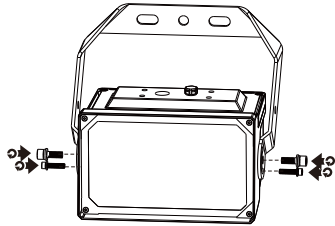

### Double Module

M8x20  
2PCS  
8.0Nm  
M5x12  
2PCS  
2.0Nm

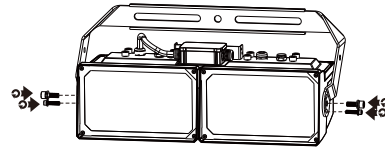

### 2. Single Module

M8x20  
1PC  
8.0Nm

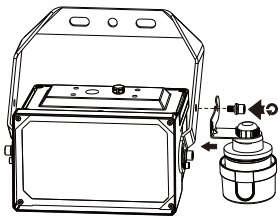

### Double Module

M8x20  
1PC  
8.0Nm

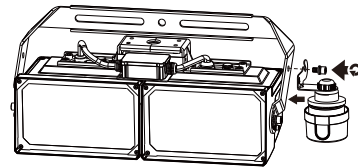

### 2. Single Module

M8x80  
2PCS  
M8  
2PCS  
1.2Nm

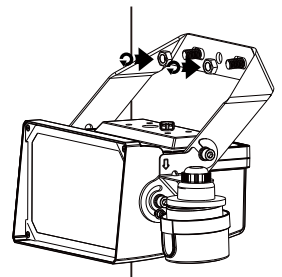

### Double Module

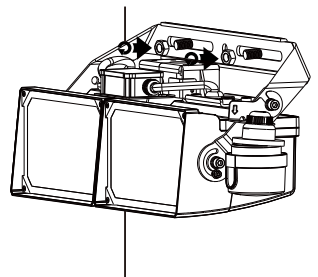

### Wall Mount(Unit: mm/inch)

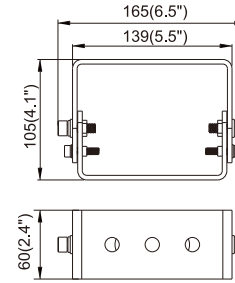

1. ✘

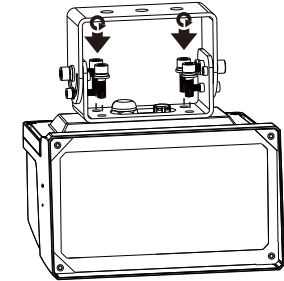

M8x12  
4PCS  
8.0Nm

2. ✘

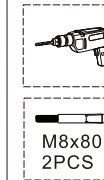

M8x80  
2PCS

3. ✘



M8  
2PCS  
1.2Nm

Product Specifications	75W	100W	120W	150W	200W	240W	300W
Input Voltage	100-277V AC / 120-277 VAC / 100-240 VAC / 220-240 VAC (Subject to the input voltage on nameplate)						
Power Frequency	50 / 60Hz						
Outlook Dimensions	233x187x141mm(9.17"x7.4"x5.6")				469x187x185mm(18.5"x7.4"x7.3")		
Luminaire Net Weight	3.4±0.3kg(7.48±0.66Lbs)				7.9±0.3kg(17.38±0.66Lbs)		
Projected Area	0.03m <sup>2</sup> (0.43ft <sup>2</sup> )				0.07m <sup>2</sup> (0.86ft <sup>2</sup> )		
Working Temperature	-30°C to +50°C(-22°F to +122°F)						
Storing Temperature	-40°C to +70°C(-40°F to +158°F)						

### Dimmable

⊕ DIM+/DA1	purple	or	purple	or	blue	or	brown	or	black	or	red
⊖ DIM-/DA2	gray		pink		white		blue		gray		orange
Aux 12Vdc +	pink		black/white		black/white		black		red		
L	brown		black								
N	blue		white								
⊕ GND	yellow/green		green								



Warning! Do not wire dim cord to high voltage, or dim function will fail.

- The light source contained in this luminaire shall only be replaced by the manufacturer or his service agent or a similar qualified person.
- For type Y attachments: if the external flexible cable or cord of this luminaire is damaged, it shall be exclusively replaced by the manufacturer or his service agent or a similar qualified person in order to avoid a hazard.