

Need Information?

Contact:

sales@ahpwelds.com

925-391-3599

Technical Issues?

Contact:

tech@ahpwelds.com

925-391-3599 (Ext. 102)

# alphaTIG 203Xi

## OPERATOR'S MANUAL

### *SAFETY AND USE INSTRUCTIONS*



*Purchase Date (Attach Receipt to Cover For Proof of Purchase)*

*Serial Number*

Issue Date: 07/13/2021

Publication: AHP203XI-101

© Ahp Welding Systems



380 Swift Ave. #11 South San Francisco, CA 94080

## CONTENTS

Shipping Issues?	3
CA Proposition 65 Warning	4
Safety First Information	5
Safety Warning, Dangers, Cautions and Instructions	6
About the Alpha TIG 203Xi	9
Warranty Statement	9
Specifications	10
Generator Operation Information	11
Duty Cycle Performance	11
Routine Required Maintenance	11
HF Point Gap Maintenance	12
TIG Shielding Gas Information	13
TIG Polarity and Tungsten Type	14
Tungsten Preparation	15
Stick Polarity and Electrode Types	15
Front Panel Features	17
Rear Panel Features	17
Control Panel Features	19
LCD Screen Features	21
Using AC Controls in TIG Welding	23
Using 2T/4T/Pedal Functions	24
Pulse Use and Operation	25
Starting the TIG Arc	26
Welding in Stick Mode	27
Useful TIG Settings	28
26 Series Air-Cooled TIG Torch Information	29
Pinout Connector Information	29
Trouble Shooting	30

# SHIPPING ISSUES?

**IMPORTANT!** This unit has been thoroughly tested and inspected for function at the factory. However, you should be prepared to inspect and test this unit completely within 72 hours after receipt. Please do not delay in doing this. Ahp needs to know if there is any damage caused in shipping as soon as possible. Damage caused by shipping and discovered after 30 days due to lack of inspection will not be covered under the free 30 day shipping policy.

Please contact us immediately should you have any questions or concerns about the welder after delivery. We'll be glad to help.

 **WARNING!**

**California Proposition 65 Warning:**

This product, when used for welding or cutting, produces fumes or gases which contain chemicals known to the State of California to cause birth defects and, in some cases, cancer. (California Health & Safety Code § 25249.5 et seq.)

 **Warning: Cancer and/or Reproductive Harm**

[www.P65warnings.ca.gov](http://www.P65warnings.ca.gov)

**NOTICE:**

Due to our constant effort to improve our products, specifications are subject to change without notice or revision to this manual. In addition, minor changes in product cosmetics, accessory type and quantity may change without notice. These do not constitute a major change in function or operation.

Ahp Welding Systems makes no warranty for merchantability or fitness for a particular purpose or application. Any claims of such are expressly denied by Ahp Welding Systems. Furthermore, Ahp Welding Systems does not accept liability for injury or damages, consequential or incidental, resulting from the use of this product or resulting from the content found in this document or accept claims by a third party of such liability.

# SAFETY FIRST!

Ahp Welding Systems takes safety seriously. You should as well. Please read this entire manual before using. Keep a copy of this manual available for all employees or potential users of this machine to read and thoroughly review before use.

No matter how detailed may be nothing can substitute for careful planning and common sense required to operate and safe work environment.

Welding is an inherently dangerous activity. Failure to follow safety protocols while welding may result in severe burns, blindness, severe shock, or death from electrocution.

**BE AWARE OF YOUR WORK AREA AND THE WHO OR WHAT IS IN IT!**

**AS THE USER OF THIS PRODUCT YOU ARE RESPONSIBLE FOR YOUR OWN PERSONAL SAFETY AND FOR THE SAFETY AND SECURITY OF THE PEOPLE AND ITEMS AROUND YOU!**

If you feel you do not have the resources to provide a safe work environment, or do not have the skills or (for whatever reason) the capability to safely operate this unit, do not use this unit until you seek professional instruction in safe operation and care of this unit.

## NOTICE:



Welding and cutting operations may generate undesirable High Frequency (HF) and EMF energy. This can interfere with surrounding electronic equipment such as computers, routers, CNC equipment, televisions, radios, fluorescent lighting etc. If disturbance in surrounding electrical and electronic equipment is noted, consult a licensed electrician to help properly ground surrounding equipment to limit the interference. This machine may cause GCFI and ground fault outlets to malfunction. This unit is designed to be operated on a dedicated, properly grounded circuit.

# Safety Warnings, Dangers, Cautions and Instructions

	<p>NOTICE. This unit manual is intended for users with basic knowledge and skillset in welding. It is your responsibility to make certain that the use of this welder is restricted to persons who have read, understand and follow the warnings and instructions in this manual. If you or the operator needs further instruction, contact Everlast welding support at 1-877 755-9353 ext. 204 or seek qualified professional advice and training.</p>
	<p>WARNING! High Frequency (HF) energy can interfere with the operation of pacemakers and can damage pacemakers. Consult with your physician and pacemaker manufacturer before entering an area where welding and cutting equipment is in operation and before using this welder. Some pacemakers have limited shielding. Alert any users or customers of this potential problem.</p>
	<p>WARNING! Use approved safety glasses with wrap around shields and sides while welding and working in the weld area or serious eye damage or loss of vision may result. Use a grinding shield in addition to the safety glasses during chipping and grinding operations.</p>
	<p>WARNING! When welding always use an approved welding helmet or shielding device equipped with at least an equivalent of a shade 9 or greater. Increase the shade number rating as amperage increase over 100 amps. Inspect helmet for cracks in lenses and in the helmet. Keep lens covers in good condition and replace as necessary.</p>
	<p>WARNING! Welding/cutting operations carry inherent risks which include but not limited to possible cuts burns, electrical shocks, lung damage, eye damage and even death. Take all appropriate measures to use proper Personal Protective Equipment (PPE). Always use leather welding gloves, closed toe (preferably reinforced or steel toe leather shoes, and long-sleeved flame resistant clothing (i.e. denim). Do not wear Poly/Nylon blend materials.</p>
	<p>DANGER! Welding/cutting poses shock and electrocution risks. Keep this welding equipment dry. Do not weld in the rain or where moisture accumulates. Use dry, rubber soled shoes, gloves and clothing when welding. Do not rest or contact work clamp (ground) when welding. Keep all parts of the body insulated from the part being welded when possible. Do not touch terminals or connections while the unit is on. Consider all parts to be "live" at all times even if no live work is being performed. Do not use frayed welding cables.</p>
	<p>CAUTION! Fires are possible but also preventable while welding. Always remove flammable rags, papers, and other materials from the weld area. Keep rags stored in an approved flame proof canister. Keep a fully charged fire extinguisher at hand. Remove any fuels, oils, paint, pressurized spray cans, and chemicals from the weld area. Make sure any smoke/fire detectors are function properly. Do not weld on tanks, drums or barrels, especially if pressurized or sealed. Do not weld on any container that previously held fuel or chemicals. Make sure the weld area is clear of flammable materials such as grass or wood shavings solvents and fuels. Do not wear frayed or loose clothing. Visual-</p>
	<p>WARNING! Welding gas cylinders are under high pressure. Keep all gas cylinders upright and chained to a cart or held safely in a safety holding pen. Never transport gas cylinders in an enclosed car van or other vehicle. Transport gas cylinders securely. Keep all cylinders capped while not in use or during transport. Replace the cap on the cylinder when it is going to be more than 24 hours before use. Do not use or attempt to repair faulty regulators. Never weld on gas cylinders. Keep gas cylinders away from direct sparks.</p>

# Safety Warnings, Dangers, Cautions and Instructions



**DANGER!** Welding and cutting operations pose serious inhalation hazards. Some of these hazards are immediate while others are cumulative in their effect. Do not weld in enclosed spaces or in areas without adequate ventilation. Fumes and gases released in the welding and cutting operations can be toxic. Use fans or respiration equipment to insure adequate ventilation if you are welding in a shop or garage area. Do not weld on galvanized metal under any circumstance. You may develop metal fume fever. Symptoms are similar to lu-like symptoms. Seek medical advice and treatment if you are exposed to galvanized welding fumes.

If you experience any eye burning, nose or throat irritation while welding, these are signs that you need more ventilation.

If you feel these symptoms:

- Stop work immediately and relocate work area with better ventilation.
- Wash and clean your face and hands.
- Stop work completely and seek medical help if irritation persists



**DANGER!** Never use brake cleaner or any chlorinated solvent to clean or degrease metal scheduled to be welded or other related equipment in the area being welded. The heating of this cleaner and its residue will create highly toxic phosgene gas. Small amounts of this vapor are harmful and can lead to organ failure and death. If degreasing of a part is necessary, use Acetone or an approved pre-weld cleaner. Use the proper personal protective equipment (PPE) when handling any cleaners/solvents.



**DANGER!** People with pacemakers should consult a physician and pacemaker manufacturer before welding. There is a potential for damage or serious malfunction resulting in death. High Frequency energy (HF)/Electromagnetic Fields generated during welding can interfere with pacemaker signals, even permanently damaging it. Some pacemakers offer some shielding, but restrictions regarding amperage and HF starting of TIG arcs may be placed upon the individual. Warn all potential bystanders that they should exit the work area if they have a pacemaker or similar medical equipment before welding. Severe electrical shock leading to injury or death may occur while using the plasma cutter if the user becomes part of the circuit path. While the Amp output of the plasma cutter is limited, the unit may produce an OCV of 300V or greater. Consult with a Physician if a pacemaker is expected to be implanted.



**DANGER!** Never defeat or modify any safety guards or shields. Keep all safety covers and shields in place.

Never place your fingers in or near a fan shroud or insert any object into the fan(s).



**CAUTION!** Trip Hazards exist around welders. Cords, cables, welding leads and hoses pose a trip hazard. Be aware of their location and inform others of their location. Tape and secure them so they will stay out of high traffic areas.

# Safety Warnings, Dangers, Cautions and Instructions



CAUTION! Welded metal can stay hot long after welding is completed. Burns may occur. Always wear gloves or use tongs/pliers when handling welded or cut metal. Remember the heat from the metal may catch other material on fire. Always have a fire-proof area ready to place welded components until they fully cool. Use soap stone or a metal marking marker to label the metal as "HOT" to serve as a reminder to all present in the area.



CAUTION! Welding and cutting operations generate high levels of ultraviolet (UV) radiation which can burn and damage skin and eyes. The intensity is so high that exposed skin and eyes can burn in a few minutes of exposure. Minimize direct skin and eye exposure to this intense form of radiation by using proper PPE and sun screen where appropriate.



CAUTION! Do not allow untrained, unqualified bystanders to observe welding. Do not allow others without proper Personal Protection Equipment (PPE) suitable for welding to stand in the welding area or to observe welding and welding related activities. If protection is not readily available, use a welding screen to separate the welding area from the rest of the area. If no protection or screen is available, physically exclude them from the welding area by a wall or other solid divider. Keep all pets and young children away from the welding area.



CAUTION! Electromagnetic Fields can be generated by this welder and radiate into the work place. The effect of EMF is not fully known. Exercise caution when welding by: NOT draping welding leads (guns/cables) over your shoulders or arms, NOT coiling them around your body, NOT inserting yourself directly between the cables, and by NOT contacting the unit while welding. DO keep the work clamp connected as close as possible to the area of the weld and directly to the object being welded whenever possible.



DANGER! Never touch connectors or fittings while this machine is turned on. Keep all safety covers in place when not in use.



## About the AlphaTIG 203Xi

The AlphaTIG 203Xi is the latest and most advanced edition of the long-running AHP AlphaTIG series. It utilizes the latest in digitally controlled IGBT inverter welding technology, providing an integrated LCD high visibility digital display. This setting allows repeatability and fine adjustment of settings and simple, intuitive setup of the machine. New *Rapid-Set* technology allows the user a “no-guess” setup experience by providing targeted Amp settings based off user inputs of metal type and thickness.

The unit comes standard with the following features:

- Dual Voltage 120/240V operation capability
- 200A AC and DC TIG output for welding all metals
- 180A AC and DC Stick output
- TIG AC Frequency adjustment
- TIG AC Balance adjustment
- 2T/4T Torch switch operation capability
- Foot Pedal operation
- HF or Lift Start Modes for TIG arc starting
- AC and DC Pulse in TIG mode
- 5 Amp DC minimum start
- 20 Amp AC minimum start
- Water Cooler Plug in the rear



The unit comes standard with the following accessories:

- Nova Long Life Foot Pedal (Low Profile)
- 26 Series Gas-Cooled TIG torch, 12.5 ft cable, 35-70 DINSE style adapter
- Basic consumable kit for TIG torch (Tungsten not included)
- Billet Brass Floating Ball type regulator
- Stick Electrode holder, 9 ft cable, 35-70 DINSE style adapter
- 2T/4T torch switch
- 250A Work Clamp, 6 ft cable, 35-70 DINSE style adapter
- 240V to 120V step down power cord pig-tail adapter

## Ahp Warranty Statement

**WARRANTY ONLY APPLIES TO UNITS WITH PROOF OF PURCHASE FROM AN AUTHORIZED DEALER. NO EXCEPTIONS. PLEASE FEEL FREE**

### TO REQUEST A LIST OF AUTHORIZED DEALERS.

All new AHP welders, shall be warrantied to the original owner for a period to extend for 3 years from date of purchase against breakage, malfunction, or other unit failure resulting from manufacturing defect. The faulty unit will either be repaired or an exchange will be made for a new or factory reconditioned unit at AHP Welds discretion. The customer must contact the technical support team to review unit failure so that the warranty claim can be established. Items such as electrodes, contact tips, nozzles, cups, shields, liners etc, considered to be consumable items, are NOT covered under warranty. Torches, foot pedals and spool guns are warrantied for a period of 6 months. Additionally, certain items such as torches, foot pedals and easily serviced parts may be individually exchanged without returning the entire unit assembly should a failure with these items occur, at AHP Welds discretion. AHP Welds will not be responsible for time/contract loss from unit failure, damages occurring from improper or unskilled operation, damages resulting from improper maintenance, improper wiring, poor quality power sources, abuse or neglect. Nor will AHP assume responsibility for the customer's failure to heed/read safety instructions, to read and understand operator's manual, obey occupational laws or to ensure the unit's safe operation complies with state or local laws, personal injury arising from the inherent risks involved with welding, including burns, electric shock or death. Warranty extends only to the machine, its accessories and parts contained inside as stated above. No other warranty is expressed or implied.

In the event of unit failure or malfunction, the customer must contact AHP to obtain a location of a designated return/repair facility. The replacement unit will then be returned to the customer. AHP will cover the shipping charges both ways for domestic customers that have units in need of warranty within the first 30 days from the purchase date. After the 30 days from the purchase date, the customer shall be responsible for all shipping and handling costs both ways of non-functioning units for repair or replacement. Customers located outside of the USA lower 48 states will have to pay shipping and handling charges both ways from the purchase date. It is the customer's responsibility to adequately insure the unit, as AHP is not responsible for lost or damaged returns. Labor coverage only applies if the unit is serviced at our facility or one of our authorized dealers. We will not reimburse the labor if the customer decides to have a third-party or unauthorized repair technicians work on the unit.

**NOTICE: Ahp's TIG products are designed for use by individuals with a professional knowledge base in TIG and Stick welding and is designed with commercial operation in mind. Ahp cannot be held accountable for instruction and training of inexperienced users or damage or malfunctions that may result from use by inexperienced users or improper installation. If you do not have the skill level or knowledge base to properly operate and install this machine, do not use this machine until proper training and instruction has been received.**

View full warranty, terms of sale and shipping details here: <https://ahpwelds.com/>

### AlphaTIG 203Xi Specifications

#### Input/Output Operating Range

Input Voltage	Welding Process	Operating Range	OCV
120V (± 10%)	DC TIG	5-150A, 10.2-16V	75V
120V (± 10%)	AC TIG	20-150A, 10.8-16V	75V
240V (± 10%)	DC TIG	5A-200A, 10.2-18V	75V
240V (± 10%)	AC TIG	20A-200A, 10.8-18V	75V
120V (± 10%)	DC Stick	20-125A, 20.4-25V	75V
120V (± 10%)	AC Stick	20-125A, 20.8-25V	75V
240V (± 10%)	DC Stick	20-180A, 20.4-27.2V	75V
240V (± 10%)	AC Stick	20-180A, 20.8-27.2V	75V

#### Duty Cycle Range

Input Voltage	Welding Process	35%	60%	100%
120V (± 10%)	DC TIG	-	150A @ 16V	110A @ 14.4V
120V (± 10%)	AC TIG	-	150A @ 16V	110A @ 14.4V
240V (± 10%)	DC TIG	-	200A @ 18V	160A @ 16.4V
240V (± 10%)	AC TIG	-	200A @ 18V	160A @ 16.4V
120V (± 10%)	DC Stick	125A @ 25V	100A @ 24V	80A @ 23.2V
120V (± 10%)	AC Stick	125A @ 25V	100A @ 24V	80A @ 23.2V
240V (± 10%)	DC Stick	180A @ 27.2V	160A @ 26.4V	130A @ 25.2V
240V (± 10%)	AC Stick	180A @ 27.2V	160A @ 26.4V	130A @ 25.2V

#### Input Demand Inrush / Rated Effective Current

Consult a local, licensed electrician before wiring your electrical connections. Reference Article 630 of the NEC for correct welder wiring code information.

Voltage	I <sub>1Max</sub> / I <sub>1Eff</sub> (Inrush/Rated)
120V	42A / 25A
240V	34A / 24A

#### Weight / Dimensions / Other

40 lbs. / 18" H X 9.5" W X 17" L / Ingress Rating IP21S  
 Use between 14°F and 104°F  
 Store between 0°F and 120°F

**CAUTION:** Use only with extension cords 50 feet long or less, rated for 240V welder 50A use, or damage may result. For 120 operation, use only with 30A rated cords, less than 25 feet in length.

#### Feature and Range

Feature	Range
Start Type	HF and Lift Start (Lift is initiated with switch or pedal only)
Process	AC/DC TIG and Stick
Amp Control	2T/4T Switch Control Sequencer or Pedal Control
AC Frequency	20-200 Hz
AC Balance	20-80% of Electrode Positive
Start Amps	5(20) to 200 Amps
End Amps	5(20) to 200 Amps
Pre-Flow	0-10 Seconds
Post-Flow	0-25 Seconds
Up Slope	0-10 Seconds (2T/4T Use only. Not for use with Pedal.)
Down Slope	0-25Seconds (2T/4T Use only. Not for use with Pedal.)
Pulse Frequency	DC: .5-250Hz AC: .5-150Hz
Pulse Time On	10-90%
Pulse Amp Ratio	5-95%
TIG Amp Range	DC: 5-200A AC: 20-200A
Stick Amp Range	DC: 20-180A AC: 20-180A
Stick Electrodes	E6013, E6011, E7014, E7018, 309L etc. are permissible <b>NOTICE: Not for use with E6010</b>

**IMPORTANT: Be responsible. Consult a local, licensed electrician before wiring your electrical connections. Reference Article 630 of the NEC for correct welder wiring code information. The code is different for wiring a welder circuit than for household circuits.**

This unit uses a NEMA 6-50P for 240V use. This is the standard welder plug for 240V 1 phase use in North America.

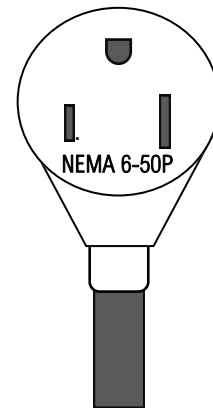

This unit is supplied with a 240V to 120V pigtail adapter. No internal adjustment or change is required to use it on 120V. Simply install the adapter. The unit will adjust automatically.

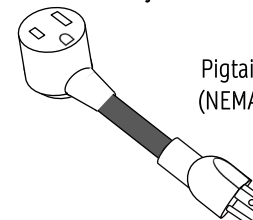

Pigtail Power Adapter (NEMA 6-50R to 5-15P)

## Generator Operation Information

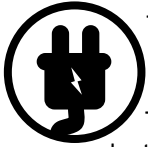

This unit may be used with any clean power rated 240V generator with a 9000 Surge Watt rating. Clean Power is defined as 5% or less Total Harmonic Distortion (THD). This means the generator produces a clean sine wave similar to what is produced by power companies. **Due to the potential high inrush Amp demand (42A) while operating on 120V, operation with 120V only generators is not recommended.**

**NOTICE:** Operation on generators not rated by its manufacturer as a “clean power” source is prohibited and will void the warranty. Many manufacturers produce a version or series of their generators that produce clean power. This is usually stated up front. If not, consult the manufacturer of the generators to confirm THD. Clean power generators are made in both inverter types and conventional types of generators. Do not assume all inverter type generators produce clean power unless the manufacturer states it. Clean power is needed for most electronic equipment to prevent damage.

## Duty Cycle Performance



The Duty Cycle of this machine has been established at 60% @ 200A (40°C) while operating on 240V. While operating on 120V, the duty cycle has been established at 60% @ 150A (40°C).

Duty Cycle is the amount of time, out of a solid 10 minute block of time that the unit may operate at the rated setting. For the example of 60% @ 200A, this means the unit may be operated up to 6 minutes continuously, or intermittently out of 10 minutes of time before overheating. The balance of time remaining in the 10 minutes (4 minutes in this example) should be while the unit is left to rest, while continuing to run. As Amps are lowered, or as the ambient temperature decreases below the 40°C testing benchmark, duty cycle will increase.

It is not necessary to try to keep up with the duty cycle exactly by timing it or recording it. The unit is equipped with a thermal sensor which will trigger an interruption of operation if the temperature has been exceeded. Keep in mind this is not a timed feature. A duty cycle statement is based on time welding at a particular amperage, but because so many variables exist, and ultimately the unit's temperature is the regulating concern, duty cycle is determined by a preset operating temperature threshold, rather than a timed one.

If you have triggered the duty cycle interrupt on this machine, allow the unit to cool for a full 15 minutes. The unit should automatically reset during this time, but allow a few more minutes so the machine can cool sufficiently so as not to overheat quickly. If it does not reset during this time, turn the machine off and back on to reset it.

Even though this unit is equipped with a duty cycle safety feature, intentionally and repeatedly surpassing the duty cycle will shorten

the lifespan of the unit. Routine overheating damage will usually leave signs that can be determined during warranty repair. Damage caused by intentional abuse of the duty cycle will not be covered under warranty.

If you find that you are constantly running into duty cycle issues, it is likely you will need a bigger machine, or need to adjust your welding strategies to comply with the duty cycle limits of this machine.

To assure maximum lifespan of the unit, never block the cooling vents in the rear, sides, or front. Keep the unit 16” away, on all sides, from any obstacle to free air flow such as a wall or partition.

## Required Routine Maintenance



Most places where a welder is in operation floating and flying debris is a factor. Dust, dirt and sparks are often present in the air. The machine will draw these contaminants in during operation and they can be deposited inside the machine onto critical components. These particles can conduct electricity and create new circuit paths, not only causing poor operation, unit lock up, but it can also cause long term damage. **For this reason, the machine should be opened up and cleaned with dry, compressed air on a regular basis, once every month in heavy use, and ever 3 to 6 months under light use. If the unit remains stored most of the time, dust still will accumulate, and this should be done at least every 6 months. When not in use, keep the machine covered. Failure to do so constitutes neglect and may void the warranty.**

To clean and service this welder:

1. Unplug the welder. Wait 10 minutes for the capacitors to discharge. (To prevent electrical shock or electrocution.)
2. Put on a pair of safety glasses to prevent debris from blowing into your eyes during this operation.
3. Remove the rear cover screws. Keep in mind there are 3 screws on the bottom of the unit that hold the cover on as well. Do not remove any other screws on the bottom.
4. Remove the rear cover and top handle.
5. Remove the steel cover screws.
6. Pull the rear cover up and to the rear while carefully watching for wires that may catch on the louvered vents of the cover.
7. Check all wires and connections to make sure they are seated and/or tight.
8. Use dry compressed air (or “canned” air) to blow the air off connections, boards, and fittings. If the unit is particularly dirty, unseat the affected connectors themselves, and blow out the connections as well.
9. Reassemble the unit. Do not forget the handle!

**NOTICE:** *Opening the unit to clean and check connections will not void the warranty. In fact it is required to maintain your in-warranty status during the duration of your warranty. However, under no cir-*

cumstances should you attempt to modify or make unauthorized changes to the welder or its programming. To do so will void the warranty.

## HF Point Gap Maintenance



This unit is equipped with adjustable high frequency points that generate the High Frequency Voltage to create the touchless HF start of the unit. Occasionally, adjustment may be needed, particularly in the first few months of operation, and periodically thereafter. This is a simple adjustment after you've done it once or twice. The point gap should be set between 0.029" to .040" for best operation. The target point gap should be between .030" and .035". A point gap that is too small may cause weak starts. A point gap that is too wide may cause electrical interference with surrounding equipment and electronic items.

The location of the points can be identified by quickly pressing the torch switch/foot pedal while looking up through the front vents of the welder. The points should arc briefly. If they do not, they may only need adjustment or cleaning. (But if after adjustment they do not fire, contact Ahp technical support at the number listed on the front of this manual.) If you do not see the arc location, look up and to the left of the unit. There will be a small board with a brass and black plastic holder along with carbon contacts in them. They will be located on a small square board with a couple rows of small capacitors and a coil/transformer on the same board.

To gain access to the points and adjust them, follow steps 1- 6 on the previous page. You will need a small jeweler's or mechanic's screwdriver, and small ignition wrench and a feeler gauge to set the points. Do not overtighten the jam nut securing the adjustment screw. Hold the screwdriver in place on the screw while tightening the jam nut with an ignition wrench. See the image below.

The board in the image below is shown inverted for demonstration purposes and is removed from the unit. Removal is not necessary. The points will be in the "hanging" position and can be adjusted through the left side of the machine. (Whole board is not pictured.)

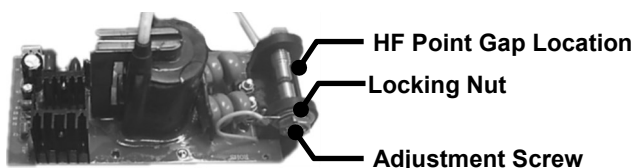

For more detailed written and illustrated directions on how to locate and adjust the point gap, contact Ahp technical support.

**NOTICE:** Point Gap adjustment is a part of regular maintenance and is a normal responsibility of the customer. Point gap adjustment and normal cleaning/maintenance does not fall under the warranty terms

for this welder. If you have any issues or questions concerning point gap adjustment, call or contact Ahp tech support before attempting the adjustment. The HF system used in this unit is only used for starting the arc. They do not stay on while welding in DC or in AC. They have no effect other than arc starting efficiency. Inverters switch so quickly in AC that HF is not needed to maintain a stable arc. **IMPORTANT:** Do not needlessly adjust the point gap in order to try to resolve operational issues not related directly to arc starting. Arc starting is the only purpose of the HF points inside this unit. Before assuming you have an HF starting issue, check the work clamp, the work clamp cable and connections under the rubber boot on the DINSE connector to make sure the connections are tight, and corrosion free. Connect the work clamp directly to a freshly ground spot on the work piece and attempt to weld before assuming you have an HF point gap issue. Also make sure polarity is correct. Most commonly, a poor connection to the work piece, corrosion or wrong polarity is the cause of poor arc starting rather than a point gap issue.

Other items that may also cause poor arc starting:

- Wrong shielding gas, or not enough flow.
- Too much gas flow creating turbulence.
- Welder is too close to the weld area and fans are blowing gas coverage off weld. Move to 6-8 feet away.
- Dirty or contaminated metal PreClean aluminum with Stainless brush or special aluminum grinding wheel. Decontaminate with acetone or aluminum cleaner made specifically for welding Aluminum. Grind steel with hard stone on grinder. Refrain from using flap disks which often polish the mill scale rather than remove it.
- Too long of an arc gap between tungsten and metal.
- Too much stick-out of the Tungsten, not enough shielding gas flowing around Tungsten.
- No Pre-Flow. Set to .3 to .5 Seconds.
- Wrong Tungsten. Use Lanthanated or Ceriated Tungsten for all processes. Do not use pure, or zirconiated types of Tungsten. Use caution when trying new or proprietary "blends". Often these have poor quality control.
- Work Clamp is not connected directly to what is being welded.
- Work clamp, cable, or connector is corroded or bad. Check all connections, including where the cable attaches to the DINSE type connector. (You must pull rubber boot back).
- Dirty Tungsten. This is often indicated by a green flare or spitting while starting the arc or while welding.

## TIG Shielding Gas Information

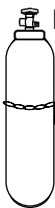
 Pure Argon is recommended for use in your Ahp TIG welder. This is the best, most tried and true shielding gas for TIG. An Argon/Helium mix may be used to increase the range of the unit. The addition of Helium has the effect of making the arc "hotter". However, when using Helium blends, do not exceed 25% for best arc starting and stability. The addition of Helium makes high frequency starting harder as well as the arc more unstable. Additionally, even small amounts of Helium will greatly increase the price of the shielding gas over Argon. There are additional shielding gas blends being offered by various welding supply stores, that include other gases, with Argon being the base. These blends are often proprietary, and are not recommended for every day use.

**NOTICE: Under no circumstance should you ever use MIG gas such as 75/25 Ar/CO<sub>2</sub> (C25) as a shielding gas for TIG welding.** The addition of CO<sub>2</sub> to the TIG weld will rapidly consume the tungsten, leave porosity in the weld, and make the weld brittle. MIG gas has never been used to weld with TIG. When purchasing your shielding gas, be sure to remind the store that you desire TIG shielding gas, or 100% pure argon. One of the most common mistakes is the use of the wrong shielding gas. If your supply store insists on Ar/CO<sub>2</sub> for TIG,

refuse the gas, and insist on pure Argon, or find another store willing to sell 100% pure argon. (Medical grade purity is not necessary).

The regulator is a floating ball type. This means that when gas is flowing the ball in the clear cylinder will float, indicating not only that gas is actively flowing, but also the amount of gas flowing through the regulator. This type is more accurate in general than the gauge type, and is easier to read at a distance. When installing the regulator and making it ready for use, be sure to snug all fittings using two wrenches. One will hold the stationary fitting, the other will be used to turn the rotating fitting. If you do not hold the stationary fitting, either on the regulator, or on the back of the unit, you can crack or damage the fitting. Once installed, and all fittings have been tightened, test all fittings for leaks with a spray of warm soapy water (or leak detector) to check for leaks. If bubbles are present, retighten. Do not use thread sealant, locking compound, anti-seize or tape to seal the threads. If the threads do not seal, remove and check the connections for debris or pieces of metal on the sealing surfaces.

When you open the cylinder valve, do so slowly and stand to the opposite side of the regulator. Do not stand in front or behind it, in case something were to malfunction or the regulator has been damaged. Open the cylinder slowly, but open the cylinder valve completely. Cylinder valves may leak if they are not fully open or fully closed.

Gas flow rates will vary by cup size and type. For standard cup sizes, use at approximately 2.5 to 3 times the gas flow rate than the cup number. For example a 7 cup would be 17.5 CFH to 21 CFH, in a good work environment. This is just a general rule, but more or less gas may be used, depending upon the circumstances.

**NOTICE: Place the unit at least 6 feet away from the weld area. The cooling fan(s) is/are powerful enough to blow the shielding gas off the weld. Do not weld with the welder sitting next to you on the table top or cart. If the welder cannot be removed from the immediate area, then lower the height of the welder by placing the welder near the floor level, or well under the work piece level. Porosity, rapid tungsten consumption, and dirty, smudgy welds may result if the welder is too close to the weld area.**

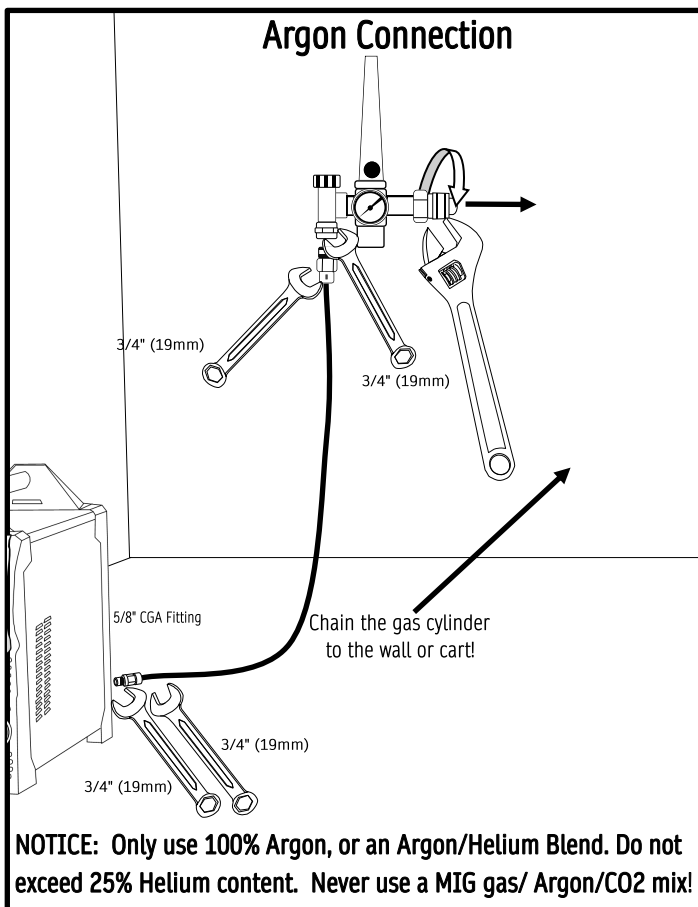

## TIG Polarity and Tungsten Type

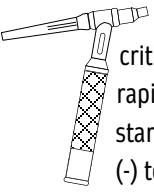

Selecting the correct TIG polarity of the connections is critical for correct operation. Incorrect polarity can lead to rapid Tungsten consumption, bad arc stability, and refusal to start. The TIG torch will always be connected to the negative (-) terminal. This is called Direct Current, Electrode Negative (DCEN -) or as "Straight Polarity". (Polarity always refers to the connection of the torch, not the work clamp.) The work clamp will always be connected to the positive (+) terminal.

**NOTICE:** *The work clamp is often referred to as a "ground" since negative (-) polarity is often viewed being connected directly to earth. However this is technically incorrect and a cause of confusion since the negative polarity only completes the circuit, rather than being grounded directly to Earth. A common issue is that people still refer to this as "ground" and mistakenly connect the work clamp the negative terminal as a result. Don't forget that while TIG welding, the work clamp will always remain in the positive terminal (+) regardless of whether it is being used in DC or AC mode.*

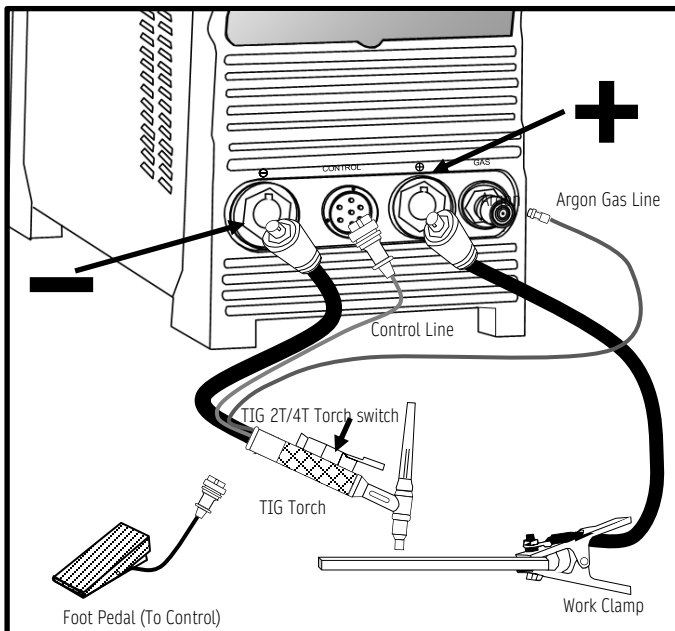

All Power Adapters are DINSE 35 Series Type (1/2" nominal pin diameter). These will be listed as either 35/70mm<sup>2</sup> or 35/50mm<sup>2</sup>.

You must choose between the torch switch operation (2T/4T) or the foot pedal operation. Both cannot be connected to the control connection or used at the same time.

Ahp recommends Lanthanated 2% (blue band) Tungsten for all TIG welding, whether welding in DC or AC modes. 1.5% Lanthanated (gold band) is also a good choice. Alternatively, 2% Ceriated (gray or orange band) also exhibits good performance, but does not have quite the resistance to erosion/consumption at higher amperages

that are found in Lanthanated. Overall, however, Ceriated is a suitable Tungsten type for most inverter welder general applications. **Never use pure tungsten (green band) or Zirconiated (usually brown band).** These are designed and intended for transformer use only. Arc instability and overballing will result. 2% Thoriated Tungsten (red band) may be used with DC, and is excellent for DC and can work for AC, but the tungsten is subject to forming nodules, splitting, and other forms of tip deformation at higher amp ranges in AC. As an alpha particle emitter, Thoriated tungsten is a slightly radioactive emitter. Some areas of the world have banned Thoriated Tungsten for this. But in general, Thoriated is still the standard for DC welding and has excellent arc properties. It's been in use in the industry for many years. The main risk is inhalation while grinding. Research Thoriated Tungsten before you make your mind up one way or the other. Be informed.

There are other types and colors of tungsten rapidly becoming available that are being promoted as 3-in-ones, tri blends, rare earth blends, special treatments, etc. Keep in mind for general welding purposes, these are still considered "novelty" products and most have very little research to support their claims of superiority for or suitability for particular applications. Some include Zirconium, which has little or no value to inverter welders. Additionally, quality control is typically very poor. The amount included of the "special" blend of each rare earth metal oxides is often miniscule and are allowed to vary by as much as 40%. Again, research and make your own decision concerning this. In particular, be sure to read the Safety Data Sheets regarding the Tungsten that should be available on these products to assist you in comparing apples to apples. Standard coloring is being changed arbitrarily by some manufacturer's to confuse the buyer, or to try to promote and differentiate their own "special" product. Reading the SDS can help clear up confusion and give you an indication of formulation and quality control standards.

**NOTICE:** Tungsten electrodes are often identified and referenced by the painted color band on the end of the electrode only. Each color represents a different type (or formulation) of Tungsten. Most Tungsten electrodes are a rare earth or special metal oxide blended with the elemental metal Tungsten. Whether it is to improve arc starting, to improve amp handling characteristics, or to reduce Tungsten tip erosion, etc., each elemental addition is claimed to serve a purpose. Tungsten varies in both metal type and content of each metal oxide. **We recommend use with Lanthanated Tungsten in AC and DC.** The content of the Lanthanum is roughly between 1.5 to 2%. The color band is blue for 2% Lanthanated Tungsten. For 1.5% Lanthanated Tungsten, it is a Gold band. The slight change in percent is said to impart different durability and performance characteristics. Research and test on your own to determine the best one for you.

## Tungsten Preparation

Proper Tungsten electrode preparation is important to arc stability and cone shape. It even has a significant effect on penetration. Different angles should be experimented with. Usually in AC mode, the grind will be shallower, and more not as steep for maximum penetration. In DC, the grind will be steeper, and longer.

The way you grind is as important as the angle that you grind as well. Always grind the tungsten so that the grind marks line up with the length of the Tungsten. Grinding radially will cause arc instability.

**NOTICE:** *On an inverter, you should never ball your Tungsten electrode to weld AC. On older transformer types this was done. But if you ball your Tungsten, arc stability will be reduced and it will affect penetration and cleaning negatively.*

Use the guide below to help you get the best performance out of your Tungsten electrodes.

	Correct length-wise grind. Smooth starts, stable arc.
	Incorrect radial grind. Hard starting, Arc starts up in Cup, Unstable arc.
	Incorrect use. Do not ball Tungsten. Hard starting, Unstable, wandering arc.
<p>DC &lt; 50 A</p> <p>2.5 - 3 X Ø (DIAMETER)</p>	Pointed for low Amp DC use. Approx. 60°.
<p>DC &gt; 50 A</p>	Pointed but tip is slightly truncated for high Amp DC use. Approx. 60°
<p>AC</p>	Pointed but tip grind is shallower for focused arc in AC use. Approx. 30°

Low cost, economical purpose-built Diamond coated Tungsten grinders have revolutionized the industry. These will usually have pre-drilled holes/slots to guide you to quickly and safely grinding the correct angle.

However, if you do not have one, you may use a bench grinder with a fine grit stone that is dedicated to grinding Tungsten only.

**CAUTION:** *Grip your Tungsten firmly so the Tungsten is not snatched from your hands. Use safety glasses, and gloves when grinding.*

See below for proper and improper grinding examples.

YES

Start with a slight upward angle. Turn Tungsten at a slow, steady rate while grinding evenly.

Gradually increase angle and continue to twist until point is created.

NO!

**NOTICE:** Never grind sideways as shown. This will create a radial grind pattern and cause arc instability and hard starting.

## Stick Polarity and Electrode Types

Stick welding is usually performed in DC with the electrode positive (DCEP+), or "Reverse Polarity". However, certain electrodes (also referred to as welding rods) also allow operation in AC or in DC, electrode negative (DCEN-). For example, the E6011 may be operated either in DCEP, DCEN, or in AC. Some people mistake it for an AC only rod, because of its ability to be used with old style transformer "buzz box" welders that only produce AC current, but in reality it will operate just as well, if not better on DCEP. Even if a welding rod allows operation in AC or in DCEN it will typically perform better in DCEP in most applications. Only a few specialty rods, like some hard facing may require AC operation only. Some manufacturers may state that some welding rods such as 7018 may be run on AC. But in general, hard starting and sticking may be experienced. To combat this, some manufacturers simply produce an AC version of 7018 for AC only welders. The use of AC usually is not needed, since DCEP is smoother, quieter, and in general offers better

penetration. However, in certain conditions, if the work piece becomes magnetized, or some part of the welding table does, then the arc may become highly unstable while welding in DCEP. High amounts of spatter and a wild, uncontrollable arc may be experienced. This usually will occur while welding in corners. In this case, this is referred to as “Arc Blow”. When Arc Blow happens, AC will usually straighten up the arc, and force it where it needs to go. Keep in mind that this is a very rare occurrence. And when AC isn’t available, or practical, Arc Blow in DCEP can be combatted by changing the location of the work clamp, or by wrapping the work clamp cable, several times around the welding table leg, or item being welded. The illustration below depicts the standard connection for most welding rods. Always consult your welding rod manufacturer’s recommendation as an ultimate source of information. Usually the box or can will have polarity recommendations along with Amp range recommendations on it if you are in doubt about settings or polarity.

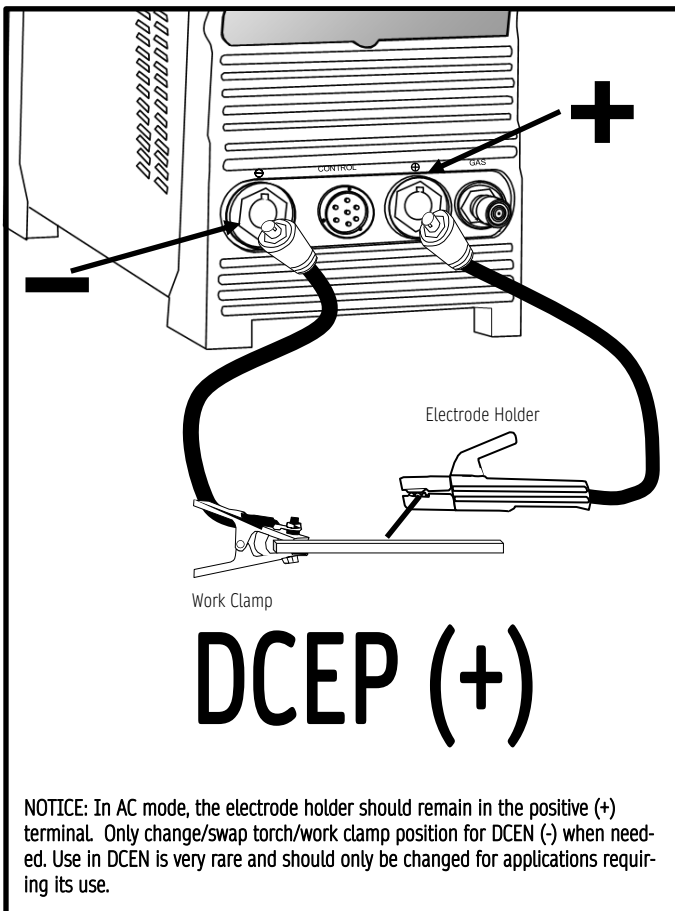

This welder is designed to weld with a variety of welding rods, including E6011, E7014, E6013, E7018, E7024, and even stainless rods like E309L. **However, this unit is not designed to weld with E6010 and should not be attempted.** Performance with E6011 may be brand dependent. You may need to experiment with different brands to find the best one for your use. This is of course true for all welding rods,

but especially for E6011 with this machine. For general purpose fabrication, and practical use, consider using E7014. This is considered a “fabrication rod”. With this rod, high-quality, rapid, self-releasing welds can be made, without having to have a hot box that is required to maintain low-hydrogen type rods such as E7018, which has similar tensile strength. E7014 rods are particularly easy to use, and leave a smooth, high quality appearance, even in the hands of novice users. The E7014 can be easily drug along the work piece while maintaining an arc. The slag is medium heavy and will self release if the amp range and technique is correct. *While in Rapid Set mode, if you decide to use E7014 select E7018. For all others listed that are not listed in the Rapid Set mode, use manual mode only.*

**IMPORTANT:** Whenever welding, this unit performs best when a tight, close arc is held. Long arc lengths will create arc outages.

This welder has a maximum output of 180 Amps while stick welding on 240V. This is sufficient to weld with most 5/32” welding rods. Running larger rods may be difficult and may make the duty cycle interrupt or over current interrupt engage. When operating on 120V, use a 3/32” or smaller welding rod. Operation at higher than 85A while on 120V may trip a 20A circuit breaker.



### Front Panel Features

When setting up your unit (especially for the first time), it is important to pay attention to the polarity and the connections of your machine. Otherwise you may experience issues with operation. Usually setup issues are the leading cause of “emergency panic calls” to technical support. Refer to the illustration below to identify the components and properly set up your unit.

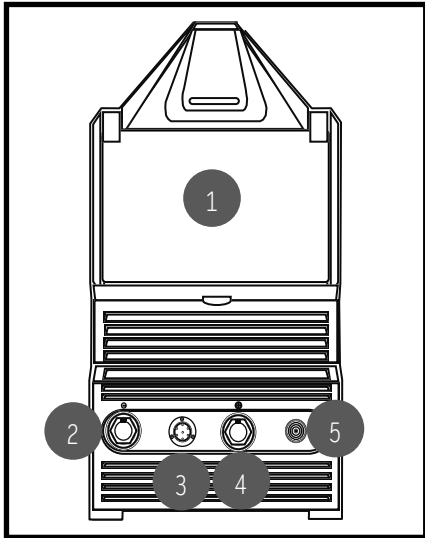

- 1. Protective Cover.** The protective cover offers protection from flying debris, dust, and damage to the front panel screen. The cover should always remain down except when adjusting the unit.
- 2. Negative Terminal.** The negative terminal is a 35/50mm<sup>2</sup> and 35/70mm<sup>2</sup> DINSE type compatible connector. In TIG mode this is the location of the TIG torch. In Stick mode this is the *usual* location for the work clamp. In some instances the stick electrode holder will be connected here in cases where DCEN (Straight Polarity) Polarity is required. Otherwise, in AC and in DCEP (Reverse Polarity) the work clamp will be located here.
- 3. Control.** The control is used for TIG welding only. This is where either the torch switch, or the foot pedal is connected while TIG welding. It allows you to start and stop the arc (torch switch and foot pedal), and/or control the amperage (foot pedal) remotely. A torch switch or foot pedal must be connected to this terminal to energize and maintain the arc. This unit does not have a live lift/scratch start function where the Tungsten remains live. This is a safety feature to prevent accidental arc starting and flashing of the eyes. **Unplug this connection while Stick welding.**
- 4. Positive Terminal.** The positive terminal is a 35/50mm<sup>2</sup> and 35/70mm<sup>2</sup> DINSE Type compatible connector. In Stick mode, this is the usual location (except of applications requiring DCEN) of the

electrode holder. The stick torch should remain in the positive while welding in AC as well. In TIG mode this is always the location of the work clamp.

- 5. Gas Connector.** The gas connector supplies gas to the torch. This is a quick coupler type connector. The unit is supplied with a gas-cooled torch (also referred to as air cooled) 26 series. The line that comes from the DINSE type connector of the torch is connected directly here. **For Water-cooled torches (optional) the gas line will run separately. The DINSE Type connector line with the quick coupling then becomes a water line. Do not confuse the two when installing a water cooled torch on this unit or water will pour from the torch head.**

### Rear Panel Features

The rear panel has a few features that may not be readily deciphered. Pay attention to the illustration and explanation below to ensure your unit is correctly installed.

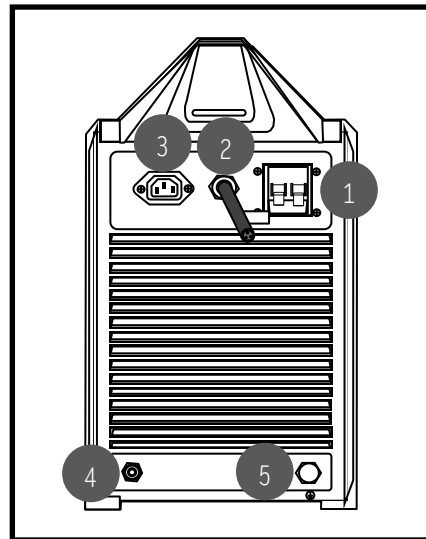

- 1. Switch.** This is the main power switch for the unit. There is no other to turn the unit on or off. The switch also serves as an “air breaker” and will trip if a short or overload occurs. If this switch trips while in use, it will usually indicate a severe problem or fault. If this trips, then the main circuit breaker in the panel box may also trip. Examine the power supply for proper wiring and grounding in the panel box. **If this trips and an error code is displayed, this usually indicates a severe internal fault has occurred.** If this happens discontinue use and contact Ahp Technical support.
- 2. Power Input Cable and NEMA 6-50 plug (Plug not pictured).** The input cable is approximately 6 ft. long. This is sized appropriately for the unit and includes the standard welder plug for North America. The standard plug only uses three wires for 240V opera-

tion. There is no neutral in a welder circuit. **Do not change, lengthen, or otherwise alter the input cable or plug. Doing so may void your warranty.**

3. **Water-Cooler Outlet** This outlet is designed for use with an optional Ahp or similar 240V water cooler only. Although this unit will supply 120V output while on 120V, the outlet should not be used while operating on 120V, unless a dual voltage cooler is being used. For safety, unplug the cooler and discontinue use while operating on 120V. Use an air cooled torch on 120V. **WARNING!** Do not use this outlet for anything other than powering an approved water cooler. This is a low amp outlet and damage and fire could result if this outlet is used for anything other than a low amp (4A or less) water cooler is used with this unit.
4. **5/8" CGA Gas fitting.** This connection is used to connect the TIG shielding gas directly to the unit. This is a standard inert gas fitting used by all major welding manufacturers in North America. Use one wrench to hold the fitting while using another wrench to tighten the fitting from the regulator tubing.
5. **HF Ground Bolt.** The HF ground bolt is used to help dissipate HF energy and possible electrical interference generated by this machine. If an electrical disturbance is noted, connect a 12 gauge wire to this bolt, and connect it directly to a separate ground rod driven into moist ground outside of shop or structure. Also, connect and ground all metal items, including plumbing and the structure itself via wire and ground to a separate ground rod driven in the ground at 10 foot intervals. This is not a recommendation unique to Ahp. It is a standard recommendation across most manufacturers in order to prevent possible electrical interference created by a welder, especially where supplied power does not meet the resistance requirements needed for a proper, commercial ground. **If you experience any electrical interference, and before resorting to using this HF ground bolt, consult with a licensed, local electrician to make sure this connection is wired and grounded appropriately, and complies with local codes.**

**NOTICE:** *This unit uses a reliable high output fan mounted in the rear of the unit (not pictured). It pulls cooler air in from the rear and pushes out spent air through the front vents and side vents of the unit. It is designed to stay on continuously. This provides the unit with exceptional duty cycle at maximum output when compared to most systems that utilize a thermostatically controlled fan. The always-on design helps the unit operate at a much lower average temperature than "as-needed" fan designs, prolonging the life of the unit. Do not attempt to modify this system in any way. Doing so will void the warranty. If the fan does not come on when the unit is switched on, or seems to be compromised in operation, contact Ahp tech support immediately.*

### Control Panel Features

The control panel layout below works in conjunction with the display. Some buttons perform a different function based on the mode they are used in. Read the information on “Control Panel Features” carefully to determine how they are used. The Rapid Set feature of this machine allows the user to set an amperage automatically based off of user inputs of material thickness, tungsten diameter (for TIG), and electrode type and diameter (for Stick). All other settings should be selected and adjusted before entering Rapid Set mode. See “Notes on Rapid Set Operation” in the next section for more information.

**NOTICE:**  
*Because of the limited output of the unit while operating on 120V, while Rapid Set is turned on, some limits are placed on selecting a Stick electrode type and size as well as material thickness in both TIG and Stick modes. These selections will still appear on the screen. However, they will be locked and will not be selectable. This is not a fault or error. It is intentional to promote the best welding practices according to industry recognized standards and limits. Of course, if a larger diameter or different type of electrode, or thicker metal thickness is desired while welding in 120V mode, turn Rapid Set Mode off and adjust manually. However, keep in mind that the results may not be satisfactory due to limited output of the machine while operating on 120V.*



#### Control Panel Features

- 1. Power Indicator and Warning Light.** The LED Power Indicator will remain on while the switch is turned on, if power is being supplied. If the warning light comes on during use, then check the error code provided to help determine whether it is an over current or duty cycle issue. If it is a duty cycle issue, allow the unit to continue to run, without welding for 15 minutes. The unit will automatically reset. If the code is a over current issue, then switch the unit off and check the cause. The unit may not clear the code when it is switched back on, or may instantly display again when welding is attempted. In this case, immediately switch the unit off and contact Ahp tech support as soon as a practically possible. Do not attempt to weld or allow the unit to continue to run if an over current has occurred.
- 2. Mode Selector.** This button is used to select the welding mode. Select from AC TIG, DC TIG, AC Stick, or DC Stick operation.
- 3. Rapid Set Selector.** The Rapid Set function of this machine gives recommended Amperage settings for this machine by allowing the user to input basic operating information such as electrode type, size, and work piece thickness (exact information required to be entered varies between the TIG and Stick Process. Once the required input values are selected on the screen, the machine computes, displays and sets the recommended Amp setting for the user. However, some conditions such as welding position, joint design, work piece temperature, operator preference etc., may affect the accuracy of these settings. If this is the case, the unit allows the Amperage to be fine tuned to suit the welding environment. The recommended amperage will also be indicated on the screen using a dial gauge with the arrow pointing vertically so that the user may return at any time to the recommended setting. Pressing this button turns Rapid Set on and off. Additional information is input via the parameter selector button (#7) and adjustment knob (#9) **NOTICE: The Rapid Set function only sets Amperage. Other features such as AC frequency, AC Balance, Pulse, Pre Flow, Post Flow, Start Amps, End Amps, Up slope, Down Slope, etc. must be set before entering the Rapid Set mode.**
- 4. TIG Pulse Selector/Rapid Set Selector (Left Arrow Button).** This left arrow button serves two functions. First, this button turns the pulse on and off while in manual mode. Pressing the button will turn on the pulse and bring up the pulse adjustment menu. Pressing again will turn off the pulse and make the pulse adjustments disappear from the screen. Second, In Rapid Set mode this button selects Tungsten diameter, or Stick welding rod and type. **NOTICE: When operating on 120V, while selecting stick diameters and types, some selections may be blocked from selection because of poor performance of the rod type and size on the lower output.**
- 5. HF/Lift Start Selector.** This button selects either HF Start (touchless start <1/8" arc gap) or Lift Start (touch down and lift up start) in TIG mode. **NOTICE: Lift Start is not a "Live" lift start where the Tungsten is always live. It must be used in conjunction with either the torch switch or foot pedal to activate the power to the torch. The torch switch or pedal should be activated before touch down of the Tungsten. While in stick mode, this button can be temporarily pressed and held to display Open**



### Control Panel Features

**6. Remote Operation Selector.** This button allows the user to select between using the foot pedal, torch switch, or special torch with separate switch and amp control on the handle. For Foot Pedal use, or slider control mounted on the torch handle, select "Pedal". For torch switch mode, select between 2T and 4T operation. For special torch with separate switch and amp control select both pedal and 2T, or pedal and 4T. Pressing the remote button several times in succession will eventually highlight both Pedal and 2T or Pedal and 4T simultaneously. See information found in the next section under: "Using the Pedal/ 2t/4T Functions".

**7. Parameter Selector (Right Arrow Button).** The parameter selector button is used to toggle between different parameters such as Pre Flow, Post Flow, Start Amps, End Amps, Up-Slope, Down Slope, AC Frequency and AC Balance. Also when the pulse is turned on with selector #4, it is used to toggle through the pulse frequency, base amps and pulse time on settings. In AC stick mode this toggles the AC Frequency and AC balance. However, in DC stick mode, this button serves no function.

**8. LCD Screen.** The screen is a LCD screen with high visibility colors with good contrast so that it can be read and adjusted in bright environments. See next page for more detail on how to adjust and select the parameters on the screen and what each represents.

**9. Adjustment Knob.** The Adjustment knob is used to increase and decrease the value of the selected parameter.

### NOTICE:

Combine the Control Panel Feature information from the above and previous page and the separate LCD Screen Operation information on the next page to understand how the each function works. Some information may be repeated or presented in a slightly different way between the two pieces of information in order to fully explain and establish how the welder operates. Be sure to pay attention to any italics, bold, and repeated information. These are key to understanding how the unit operates and is controlled.

## Component Identification and Explanation of Function

### NOTICE:

The LCD Screen depicted below is shown with all features displaying at the same time, in order to give a full picture of how the screen works. However, all of the segments and features will never be on at the same time (except during the boot cycle). Only the relevant selected information will be displayed. When selecting parameters for adjustment, the parameter (#7, #8, #9) will be underscored by a red box to indicate which is selected. In Rapid Set mode the input parameters (#5 and #6) will flash to indicate the selected value.

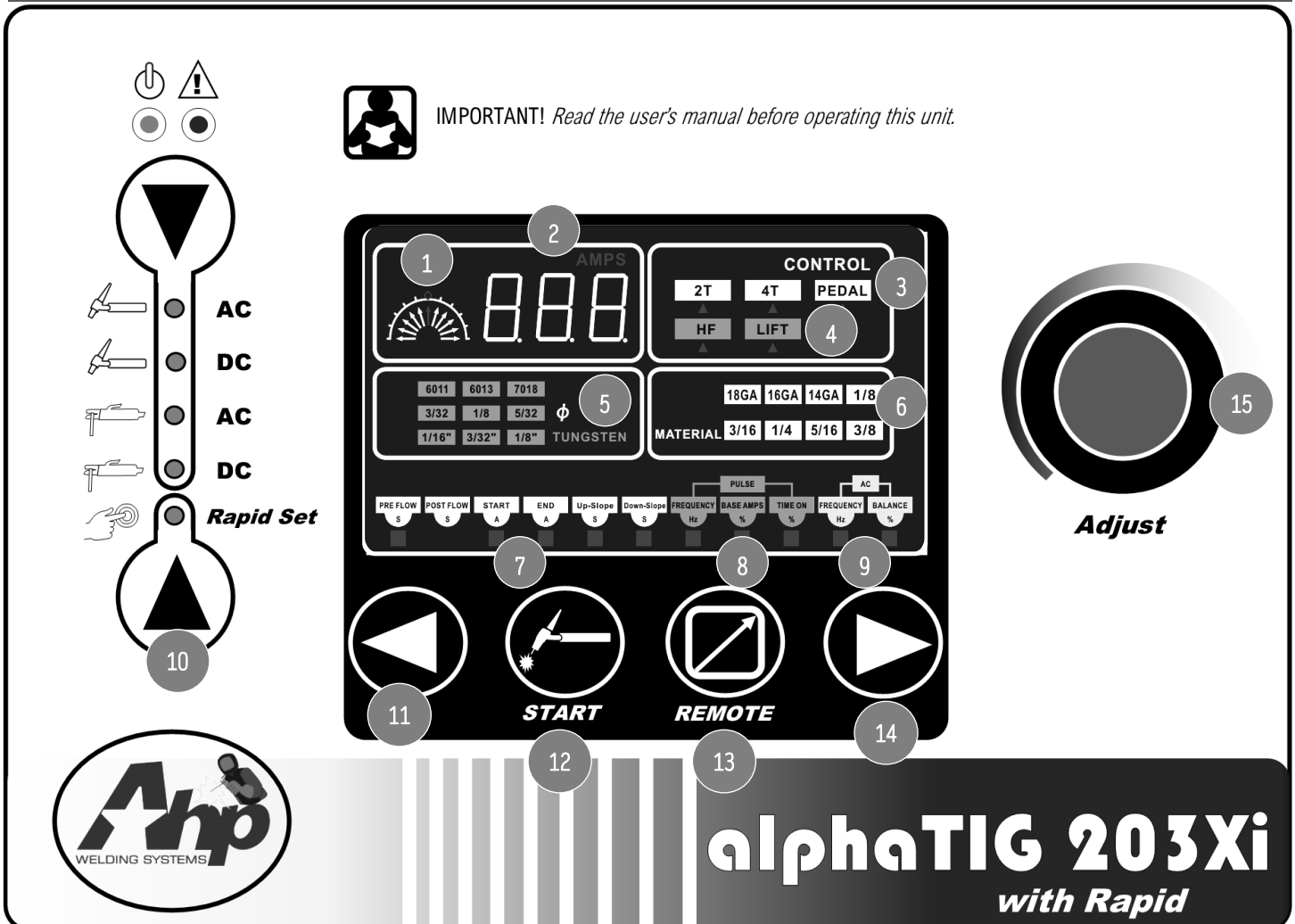

### LCD Screen Features

- 1. Suggested Setting Indicator.** This setting indicator only appears and is used only when the Rapid-Set function has been activated. The default suggested parameter will show the in the digital display to the right and the arrow will be vertical and turn red. As the amperage is fine tuned the arrow will turn right and either rotate left or right depending upon whether the amperage is increased or decreased manually with the adjustment knob.
- 2. Amp/Value Display.** This section displays selected welding Amps as a default. However, when one of the parameters (#7, #8, or #9) is selected, it displays the value of the selected parameter. In default mode the word "AMPS" will appear above the digits to indicate the value it is displaying. When a parameter has been selected for adjustment, the word "AMPS" will disappear (unless Start Amps or End Amps are selected. If either are selected the red "Amps" indicator above the digits will return). Refer to the value shown in the rounded bottom portion of the selected parameter. The values represented by the display include Seconds (S), Amps (A), Frequency (Hz), and Percent (%).
- 3. Remote Control 2T/4T/Pedal Indicator.** This section consists of the choice of operation between operating with the torch switch (2T, or 4T) or the Pedal. The Remote (#13) selector is used to highlight the desired setting. It also allows the user to select a combination of pedal and 2T or 4T settings. Selecting the combination of 2T/Pedal or 4T/Pedal, is reserved for special optional torches with a separate start/stop switch and a amp control knob. This type of torch is usually used in settings where a foot pedal isn't practical, and where some amp modulation may be required between welds. It works similar to the standard torch switch with the 2T/4T sequencer, but the amp control knob on the torch provides limited amp adjustment between different welds.
- 4. HF/Lift Start Indicator.** Using the HF/Lift Start Selector (#12), select either HF start, or Lift Start Function. See the "Starting the TIG Arc" information later in the next section on how to perform lift starts.
- 5. Tungsten Diameter/ Stick Welding Rod Type and Diameter Indicator** When Rapid Set is selected for either TIG or Stick, this area appears and becomes active. The upper row and second row refers to Stick welding rod type and diameter and is only active in Stick mode. The bottom row in this section is active only in TIG mode. Use the left Arrow Selector button (#11) to select the size/type of electrode you are using. Keep in mind, while operating on 120V, some sizes and types of stick electrodes are locked from being selected,

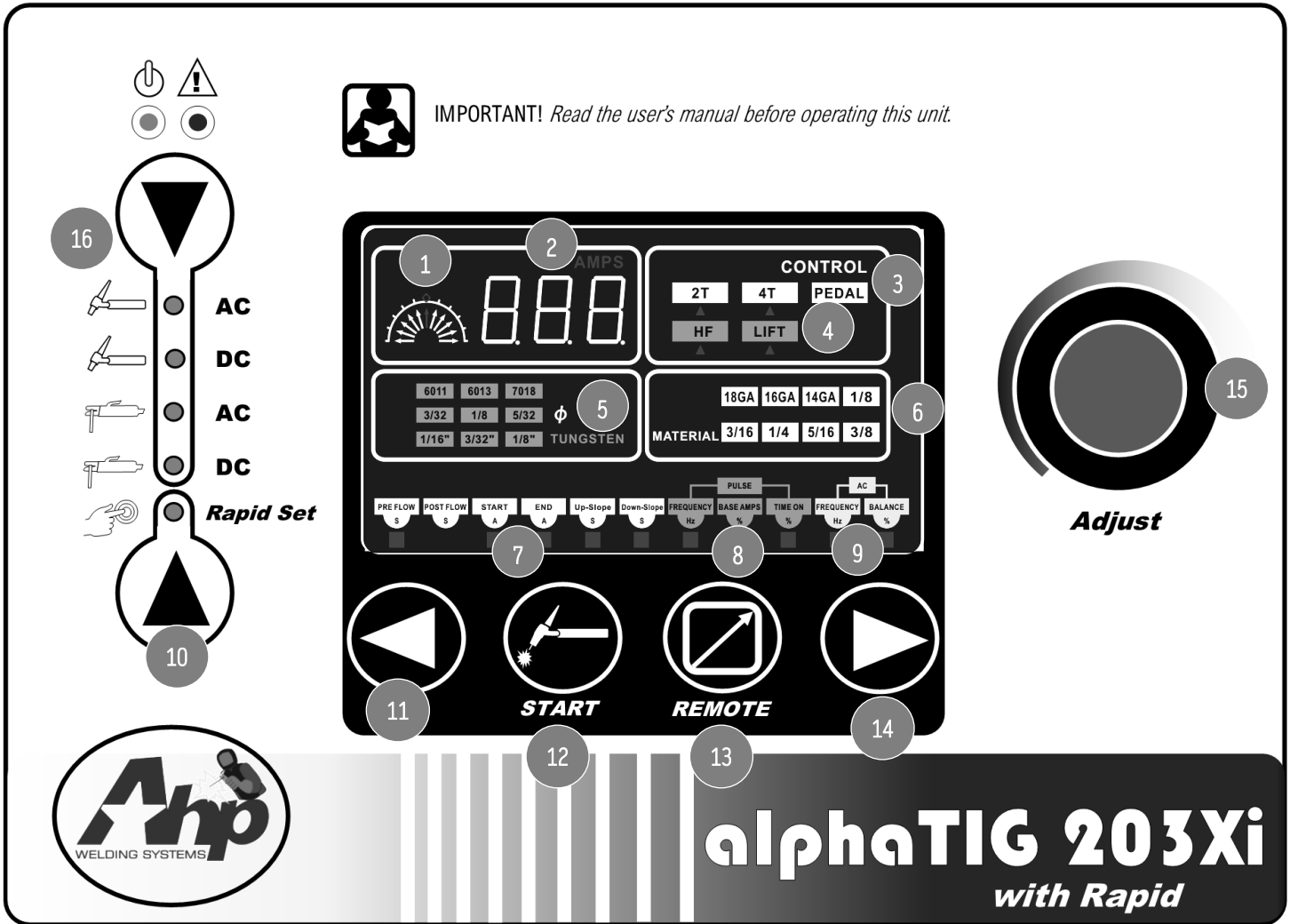

### LCD Screen Features

**6. Material Thickness Indicator.** When Rapid Set is selected for either TIG or Stick, this area will appear and become active. Select the approximate material thickness that is being welded with the right arrow (#14) parameter selector button. Keep in mind while operating on 120V, some material thicknesses are locked and cannot be selected.

**7. Weld Cycle Parameter Sequencer Indicator.** During the weld cycle, depending upon whether 2T, 4T or pedal is being used, there are certain adjustable parameters that follow in a sequence that can be adjusted for better performance. These are (in order on screen): Weld Amps (Main display default) Pre-Flow, Post Flow, Start Amps, End Amps, Up Slope, Down Slope, In order of occurrence, the weld cycle is as follows: Pre-Flow, Start Amps, Up Slope, Weld Amps (main display), Down Slope, End Amps and Post Flow. Use the right arrow key (#14) to select the parameter. **NOTICE: A red box will appear under the selected parameter.** Then use the adjustment knob (#15) to increase or decrease the value of the highlighted parameter. With the 2T/4T torch switch, all the parameters may be set. See next section for further discussion and illustration how these are controlled. **However, in Foot pedal mode, Up Slope and Down Slope will be unavailable for adjustment to prevent pedal malfunction.** For best results with the foot pedal, set Start and End Amps to a lowest setting unless a larger tungsten size is used. Then adjust up only 5 to 10 Amps. Pre and Post flow should be set according to patterns of use. High amp sustained output will require more post post flow. Pre Flow can usually be set to .3 to .7 seconds. If it is windy or a long torch cable is used, more pre flow may be required.

**8. Pulse Parameter Indicator.** When the left arrow button (#11) is selected in manual TIG mode the pulse segment and parameters will appear in blue. *(The left Arrow key serves a different function when Rapid Set is turned on in TIG mode.)* Details on the components of the pulse and how they function can be found in the next section. Use the right arrow key (#14) to advance through the Weld Cycle Sequencer Indicator segments until the desired Pulse parameters are underscored by the red box. Use the adjustment knob (#15) to increase or decrease the value of the selected pulse parameter.

**9. AC Frequency and AC Balance Indicator.** When AC TIG or AC Stick (#16) is selected, this segment will appear in yellow. Use the right arrow button (#14) to advance to the AC adjustment parameters. See the discussion on "AC Controls in TIG Welding" for more information. These controls also work in AC stick mode and their effect while welding stick is similar to what is described for TIG.

**10-16.** These panel functions and their operation are already discussed in the above information. For more detail information on their functions see the previous "Control Panel Features" on pages 19 and 20.

## Using AC Controls in TIG Welding

Alternating Current (AC) is needed only for welding Aluminum, and Magnesium. It is called Alternating Current because the polarity of the electricity is constantly cycling back and forth between electrode negative and electrode positive. In the electrode negative stage, electrons from the Tungsten tip to the work piece. In the electrode positive stage, electrons from the work piece to the Tungsten. In practical terms, you can envision DC current that is changing direction of flow rapidly, back and forth, always changing polarity (direction of current flow) many times a second. This rapid cycling action between electrode positive and electrode negative creates a force that helps to break up and remove the nearly impenetrable oxide layer. This force is referred to as "cleaning" action. The electrode positive portion of the cycle is actually responsible for this cleaning action. The cycling back and forth though is necessary though because electrode positive provides little penetration. That is why the cycle cycles back to electrode negative, to provide penetration to the cleaned area of metal provided by the electrode positive cycle.

The oxide layer on Aluminum (and on Magnesium) resists melting and melts at a much higher temperature than the Aluminum itself. Often, without AC, or with poorly adjusted AC, the Oxide layer will never melt or be removed, and the underlying aluminum will create a large pool of molten metal and "blow out" the bottom of the weld suddenly.

The rapid cycling of polarity in AC breaks up the thin, but tough oxide layer and exposes the fresh Aluminum underneath the oxide so that a puddle can be formed and filler metal added, resulting in a bright, clean puddle. As already mentioned, the portion of the AC cycle responsible for the cleaning action is Electrode positive. However, AC welding requires more amperage to weld in general than a metal welded with DC because some of the heat is removed from the metal and placed back on the Tungsten when polarity is switch to Electrode Positive as electrons reverse their flow. In older transformer models the amount of Electrode Negative and Electrode positive present in one complete AC cycle (1 Hertz) were basically equal in length. This 50/50 split would cause the Tungsten to ball, and would slow forward travel speed. But as it turns out, it does not take a 50/50 split in the balance of Electrode Negative and Electrode Positive to provide enough cleaning for welding Aluminum. In fact, thanks to modern technology that is able to take the basic sine wave input from the power company and "chop" it up into pieces, and reconfigure it, good welding results on Aluminum have been achieved with as little as 5 or 10% electrode positive. The overall effect is improved welding speed, better wet in with lower Amperage, and longer Tungsten life. **With the Ahp inverter technology, the amount of Electrode Positive present in the AC cycle can be adjusted through the use of the AC balance control. Think of the AC**

balance control on this unit as a tool that can be used to divide the AC weld cycle from 20% electrode positive all the way up to 80% electrode positive.

Normally, for most purposes, the cleaning setting on this machine should range between 20% to 40% Electrode Positive. Lower than 20% will require very careful preparation of the metal with extensive pre-cleaning with a stainless brush and special aluminum cleaner (or acetone). However, it can be done. When the AC balance is turned higher than 40%, you may notice that the tungsten begins to ball (remember the old transformer settings of 50/50 split?). The arc may become unstable and begin to wander. While Cleaning action may increase, it may begin to overclean and produce wide cleaning lines, which are unsightly and undesirable. The arc may actually begin to flutter, or act like it is cutting on and off. This is called over-rectification and is common when traveling too slow while welding area creating a wider cleaning zone (often because not enough amps are being used or the unit is being used at its maximum on a piece too thick for the welder) or while using too much cleaning on the knob. Once you exceed 50%, large balling of the Tungsten may occur and the arc becomes increasingly unstable.

Why have a welder then, with cleaning up to 80% if it is going to cause problems when it is adjusted over 40%? Because, if you have exceptionally heavy oxidized or dirty aluminum (such as many cast aluminum materials), it may be necessary to add more than normal cleaning. In this case, a larger Tungsten diameter may be required to prevent it from over heating.

See the following illustrations representing AC Balance and its effects.

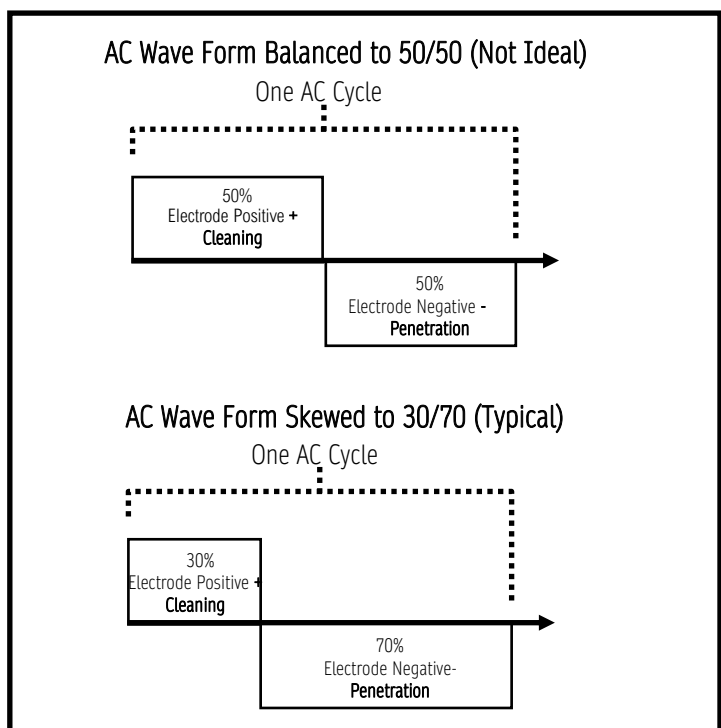

## Component Identification and Explanation of Function

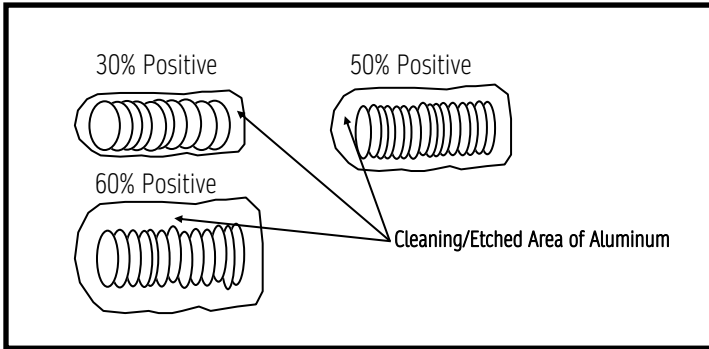

You'll notice from the illustration above that the cleaning area becomes wider as percent of electrode positive increases. In reality, only a narrow band such as represented in the 30% example is desirable. Keep in mind that as the electrode positive increases, you'll also experience more arc instability and a bigger Tungsten ball that may become unmanageable and may melt and drop off into the weld.

Another improvement offered by this Ahp inverter welder is the ability to adjust the frequency of the AC cycle. The base frequency of older transformer welders in the North American Market was only 60 Hz. This is the same frequency supplied by the power company. A transformer welder can only change the amperage that is being put out, but not the frequency. With an inverter, the frequency of the AC cycles can be adjusted as well. On this model it can be adjusted from 20 to 200 Hz.

The advantage of being able to adjust AC frequency is that the arc cone width can be controlled and the ability to direct the arc where it is needed is increased. Since this inverter can operate without a ball, and can use a pointed Tungsten, the ability to adjust the arc cone width is significant. Balled Tungsten creates a wide, and often times a wandering arc. For pinpoint precision welds, this is undesirable. Raising the AC frequency has the effect of narrowing the arc cone width and making it highly directable, while preventing the weld from overheating. It also helps preserve the point on the tungsten. This is perfect for precision welding on thin materials, and corner joints.

The trade-off to raising AC frequency too much is that the puddle may not wet in as well and may reduce travel speed too much on thicker materials. Additionally, arc pitch increases, and can be uncomfortable without hearing protection.

For thicker metals, a lower frequency is typically desired, as it provides a more fluid puddle and a wider arc. The lower frequencies offered by this welder are useful for extending the range and capacity of this welder. While welding at frequencies lower than 60 Hz, you may experience a "flapping" sound to the AC arc, arc wander, and increased rate of tungsten erosion. However, you can boost the capability of the welder by using a lower frequency as long as you are aware of the tradeoffs and willing to manage them.

Normally, frequencies between 90 and 120Hz are desirable and offer a

nice broad range that balances arc cone width, tungsten life, and noise levels without presenting problems associated with either extremely low AC frequency or extremely high AC frequency.

However, when needed, the AC frequency adjustment between 20 and 200Hz of this unit can be extremely useful for almost any application.

See the illustration below too see the effects of AC frequency on the weld.

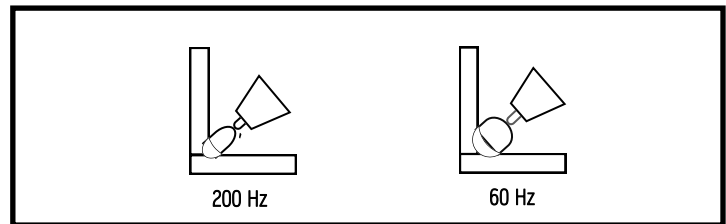

**NOTICE:** It may appear that welding at higher frequencies may increase penetration. While some additional penetration may be achieved in some circumstances, much of what appears to be additional penetration is simply the change in ratio of penetration to arc cone width. Notice in the illustration above, that at 200 Hz, the penetration appears to be greater, but in reality the arc cone is narrower, while penetration isn't greatly affected when compared to the 60 Hz example.

## Using the Pedal/ 2t/4T Functions

The 2T and 4T options on this unit may be confusing at first. To be clear, 2T and 4T operation is only intended for use with a torch switch. This unit does include a removeable torch switch on the torch.

The torch switch is not designed to provide variable Amp control. Rather it is used to control the preset programming on the unit centered around a preset welding Amperage. This often referred to as a "remote" or a "remote sequencer" as it simply signals what the machine is to do based off the function set on the machine. Each press or movement of the torch button signals the machine to change to another stage (or stages) of the welding cycle.

What is controlled with the torch switch? The following weld functions are associated with and are controlled/activated by the torch switch **This series of functions grouped together is also called the weld cycle sequencer.**

- Pre Flow / Post Flow
- Start Amps/ End Amps
- Up Slope / Down Slope
- Start Amps / End Amps

Depending upon whether 2T or 4T is selected, each movement/press of the torch button signals the machine to leave one or more functions and proceed to the next one or group of functions.



2T operation is the simplest way of welding. It is a simple “press and hold” function to operate the weld cycle. When you press and hold the torch switch trigger, the Pre-Flow is activated. Once the Pre-Flow has timed out, based off the number of seconds set on the machine, the machine will instantly start the arc at the Start Amp setting and proceed instantly to ramp up and weld at the welding amps selected on the panel. Once you are nearing the end of the weld, the trigger is released and the unit enters the downslope phase of the weld cycle and it downslopes all the way to the End Amp stage before the Post-Flow cycle begins automatically to provide shielding and cooling. See the illustration below.

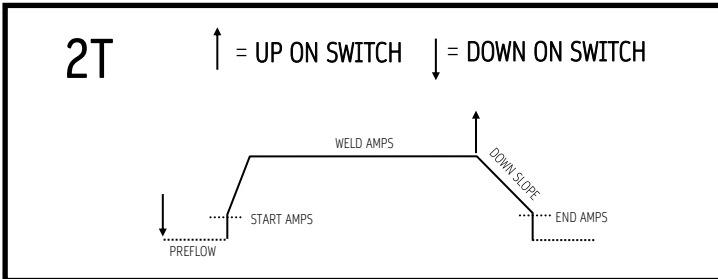

4T offers a bit more control to the weld cycle, though it is a bit more complicated. Pressing and holding the torch switch trigger down initiates Pre-Flow timer and Arc Start at the Start Amp Level set on the machine. Releasing the trigger ramps the Amperage immediately up to the Welding Amps. Welding is continued without the finger on the torch switch. Once the weld is ready to be terminated, the trigger is pressed and held again to initiate the down slope stage of the cycle. Once the End Amp stage is reached, the trigger can be released and the arc will terminate and Post Gas flow will begin. See the illustration below.

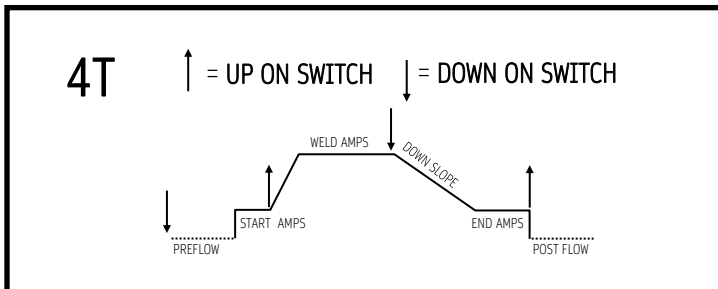

**NOTICE:** *Whether the welder is in 2T, 4T or Pedal mode, the amount of Pre-Flow time selected will delay arc starting by that amount. Don't forget that Pre-Flow does delay Arc Start.*

In Pedal mode, the foot pedal is used to operate and control the weld cycle manually. The amperage can be varied throughout the range, with the welding amps setting on the machine serving as the maximum Amps the pedal can provide. **Only the Pre Flow, Post Flow and Start Amps should be used with the foot pedal. End Amps may be used, but arc tail off will be affected. Use a slightly higher Start Amp value for larger tungsten sizes for cleaner starts. A slight bump up in End Amps may be used for large tungstens to prevent sputtering at the end of the weld. Use this additional End amperage carefully as a crater could be left.** Pre-Flow is automatically initiated once the pedal is stepped on. The arc will start at the designated Start Amp level as the pedal is pressed after the Pre-Flow cycle is completed. The Am-

perage may be varied throughout the range from minimum to the maximum Amperage set on the panel. When the pedal is backed down, and eventually released, the Amperage will respond simultaneously until the End Amp setting has been reached. Once the pedal is fully released, post flow will start.

**NOTICE:** *A special 2T/Pedal or 4T Pedal mode is available on this machine. Operation is similar to 2T or 4T modes, but is designed to allow amperage to be set and fixed at the torch handle on special torches equipped with both an amp control and a separate torch switch to start and stop the arc. This type of setup reduces traveling back and forth to the welder to adjust maximum amperage while maintaining the precise control and timing of the weld cycle via sequencer settings that you have programmed.*

## Pulse Use and Operation

The TIG pulse consists of two amp values, a high and a low value that cycle back and forth between each other while welding. The upper amperage is called the Peak “Welding Amps” (sometimes referred to as “Peak” current.) The lower amperage is called “Pulse Base Amps” (sometimes called “background” or “base” current). Pulse has several uses and can be used to control arc directability, arc cone width, heat spread, penetration and even weld appearance. It is particularly useful on metals that are prone to structural deterioration or burn through. Pulse creates a lower Amp average, and “heat” by varying one or more of several adjustable parameters of the pulse. Below is a more detailed explanation of the basic controls found on this welder that are used to control the pulse and how to get the most out of it.

**Pulse Base Amps.** Base Amps is the low Amperage value of the pulse. When you adjust the base Amps in pulse mode, you are actually setting a ratio of base Amps to peak welding Amps. Base amps are expressed as a percentage of Peak welding Amps. So, when you set base amps, you are only setting it as a percentage, not the actual Amps. As you increase Peak welding Amperage through the use of the foot pedal, or the panel control, the pulse will maintain the same ratio of Base to Peak welding Amps, raising the base Amps automatically. The foot pedal controls both Peak welding Amperage and Base Pulse Amperage simultaneously, using the pre-set ratio. **NOTICE:** *At lower Amps, the pulse may seem to disappear. This is normal since the once the unit drops below the minimum Amp capability of the machine, the pulser has no other option but to zero out the effect of the pulse. For example, if you are operating at a maximum Amperage of 30, and the Pulse amps are set to 10%, that would mean the pulse Amperage would be at 3 Amps, which is below the machine's capability. The value will then be ignored and the pulse effect muted.*

**Pulse Frequency.** Pulse speed or frequency as it is referred to is measured in the standard unit “Hertz.” Simply, it is the number of pulses

Component Identification and Explanation of Function

per second that occur. Pulse frequency controls the arc constriction and also helps with heat management. The slow pulse frequency of 1 hertz gives a "stacked" appearance. At higher frequencies the "stacked" appearance will be lost while heat control is maximized.

**Pulse Time On (Balance).** Pulse Balance is the percentage (%) of time that the pulse stays in the TIG (Peak) pulse Amp stage of the cycle. Increasing the Pulse time-on will increase the duration the Peak Amp stage of the cycle which in turn will increase the heat and will increase penetration. Pulse Balance is also known in the industry as "duty cycle". This machine uses the term "Pulse Time On" to help convey the meaning and use of the function. See the illustration below for a better visual understanding of what is happening during the pulse cycle.

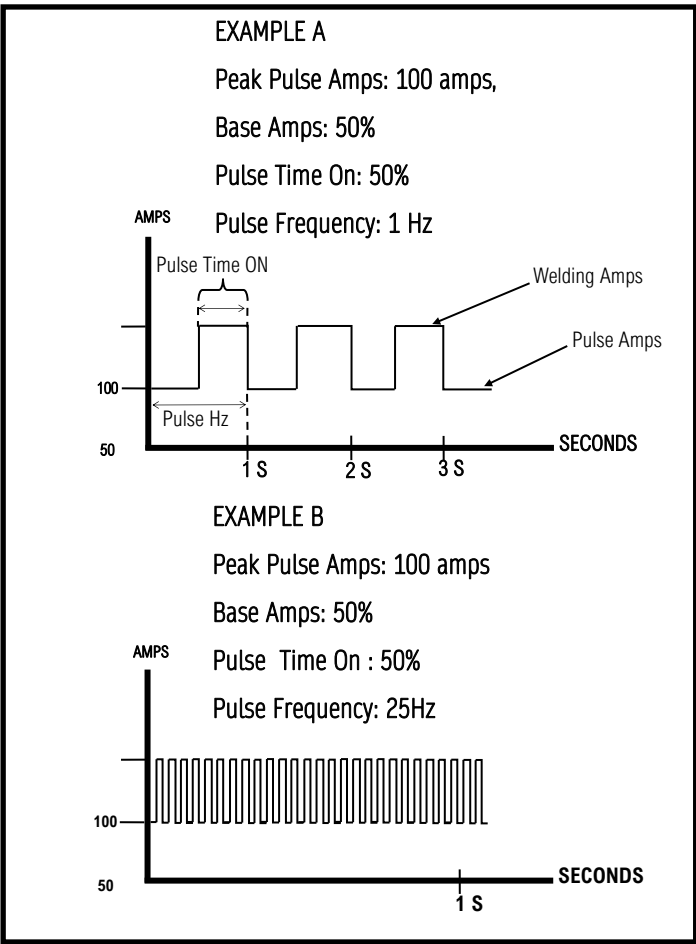

**NOTICE:** *Do not confuse AC frequency with Pulse Frequency. They are not the same thing. This unit allows Pulse to be used in AC mode.*

### Starting The TIG Arc

This unit allows the unit to be started in two ways. The first is High Frequency start. The High Frequency (HF) Start means that the arc can be started without touching the metal. When either the foot pedal or the torch switch is pressed (after the Pre-Flow cycle has fin-

ished) the arc will jump from the Tungsten tip directly to the metal.

The High Frequency start is preferred while welding on Aluminum since it does not tend to wear or contaminate the Tungsten with weld metal, or the weld metal with tiny pieces of Tungsten. It is also preferred for most DC applications that are performed in shop environments. However, HF can interfere with sensitive electronic equipment. See the safety and warnings sections for more information concerning the use of High Frequency.

See the illustration below how to properly start a TIG arc with HF selected on the machine.

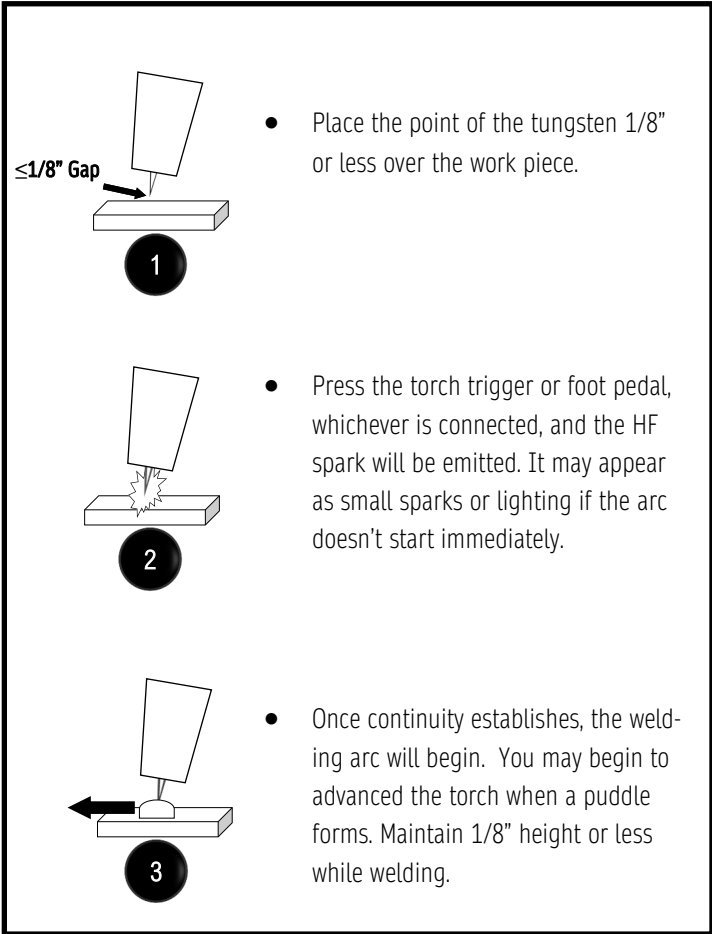

There are times when an HF arc isn't permitted or isn't convenient. Areas around hospitals and computer rooms aren't safe for using HF starts. For DC operation HF is certainly helpful and results in exceptionally clean welds, however it isn't always practical.

For this type of situation, this unit features a switched version of lift start. This means that the Tungsten must come into contact with the metal to start the arc. To activate the lift start, the torch switch or foot pedal is pressed, then Tungsten is touched to the metal and the arc is started as the torch is lifted up.

This type of start if not done properly may result in the tungsten

slightly sticking to the work piece. It is best performed with low DC start Amp values, 20 Amps or less. In AC, Lift start may be also performed, but it is not generally recommended due to increased tungsten contamination at start. A proper lift start must be done quickly, with a snap of the wrist without scratching across the surface. **Do not confuse this with a method known as “scratch start”.** Scratch start involves a live Tungsten and puts full output to the Tungsten during the start. The lift start on this unit is not live and a torch switch must be used. Additionally the gas flow is also controlled through the use of the torch switch or foot pedal. When using the Lift Start on this unit, use a short Pre-flow. Use the following illustration to guide you to performing quick, easy Lift Starts.

- Rest the edge of the cup on the work piece so that the tungsten is slightly off the work. Press the trigger or foot pedal. Quickly rotate the tungsten to the work using the cup edge as a pivot.
- A small spark may be noticed as it touches. Once the Tungsten touches, quickly and seamlessly rotate the cup back to draw an arc.
- Raise the cup to establish the arc to 1/8" or less in height.
- Allow the puddle to form and move the torch forward maintaining 1/8" or less height.

≤1/8" Weld Height

## Welding in Stick Mode

The stick function of this unit is designed for general purpose stick

welding. It is not designed for E6010 and some other types of cellulose based flux rods. Ahp recommends that rods such as E6013, E7014, and E7018 be used. E 6011 may be used as well, but you may have to experiment with brands to determine the best performing rod for you.

There are two basic methods of starting a stick welding arc. The first is a basic tapping method. This works well once with some practice. The rod is lightly, and quickly tapped (often double tapped quickly) to start the arc. This should be a controlled, tight motion. The built in hot start of this unit naturally lends itself to the tapping method. The second method is a scratch start method, which is similar to a striking a match. The tip of the electrode is quickly flicked across the metal. This should not be an exaggerated motion, but a tight controlled one for best results.

Use the illustration below to guide you in performing arc starts in the stick welding mode.

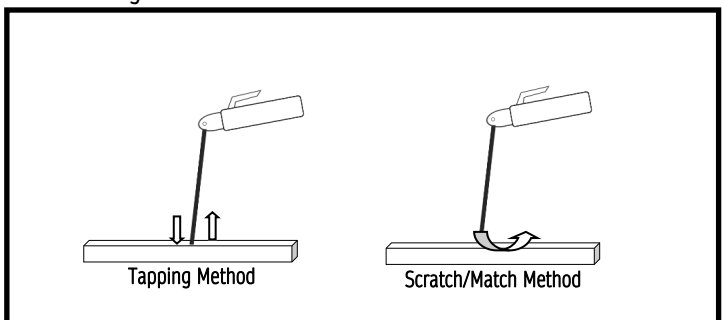

Welding in Stick mode involves simply dragging the rod in a straight line along the metal. Years ago, it was common to manipulate the rod in tight circles, or C-shaped patterns to get the metal to flow across a wide area. It is still common to see many welders use this method. However, after much research into weld strength, porosity and other factors, it has been determined that a simple dragging motion in a straight line yields the best results. This is known as the “stringer” method. The stringer method does not preclude any manipulation of the rod, but any manipulation should be very controlled and tight. The rod manipulation should not exceed the width of the weld pool.

Additionally, the rod should be leaned at no more than a 20° angle in the direction of the weld travel. This means that the electrode holder (also referred to as a stinger) is held slightly in front of the puddle as the electrode tip leads the edge of the weld puddle.

The final weld width should not exceed 2.5 times the width of the welding rod. This does not include the flux. This counts only the metal filler itself.

## Useful TIG Settings

It is very hard to recommend a welding setting that is good for all applications. In reality, there is no such setting. However we have compiled a few basics that you can use to help you in many different settings. Keep in mind these are only general settings and will need to be fine tuned. Welding position, joint design and even ambient temperature will play a part if the exact settings you will need.

### For TIG welding in DC use the following recommendations:

Pre-Flow: .3-.5 Seconds

Post-Flow: 3-5 Seconds, or 1 second for every 25 Amps

Start Amps with Pedal: 5-20A (Use more Start Amps with larger tungsten diameters. For Example: 1/16 Tungsten =5 Amp min. start 1/8 Tungsten= 20A min start)

End Amps with Pedal: 5-15A

Downslope with Pedal: 0 Seconds

Start Amps with torch switch: 10-20A (depending on tungsten size)

End Amps with torch switch: 5-20A (depending upon arc tail-off concerns and tungsten size)

Down Slope with torch switch: 3-5 seconds

Amps: With pedal, 1 amp per thousandth of an Inch with pedal. Subtract 15% to 25% with torch switch. (up to .125", after that consider using multiple passes)

### For TIG welding in DC using Pulse, the above basic recommendations except:

Welding Amps: 1 amp per thousandth of an Inch plus 5-15%

Pulse Amps: 40-65% of Welding Amps

Pulse Frequency: 100-150Hz for heat control, 1 to 2 Hertz for appearance

Pulse Time-On: 50-75%

### For TIG welding in AC use the following recommendations for general use.

Pre-Flow: .1-.5 Seconds

Post-Flow: 5-10 Seconds, or 1-2 seconds for every 25 Amps

Start Amps with Pedal: 20A (30A with 1/8" Tungsten)

End Amps with Pedal: 20A

Downslope with Pedal: 0 Seconds

Start Amps with torch switch (recommend using foot pedal, but if required): 1 amp per thousandth of an inch thickness plus 25 to 50% (may overball tungsten or consume it rapidly if Tungsten is under-sized)

End Amps with torch switch: 20A

Down Slope with torch switch: 4-7 seconds

Amps: With Pedal 1 Amp per thousandth of an inch plus 25%

With torch switch, one Amp per thousandth

AC Frequency: 90-100Hz

AC Balance: 20-40%

### For welding with AC pulse, use the above settings except:

Welding Amps: 1 Amp per thousandth of an Inch plus 25%

Pulse Amps: 50- 75% of Welding Amps

Pulse Frequency: 1.5 to 3 Hz for appearance; 100 to 200 Hz for Heat control.

Pulse Time On: 50-65%

## Notes on Rapid Set Operation

Rapid Set mode is useful for quick setup and adjustment of Amperage without having to refer to complicated charts or computer apps. However, you will need to know and input several pieces of information about what you are welding to accurately use the Rapid Set mode. For TIG you'll need to know and enter the following:

- Material (metal being welded) thickness, or closest approximation. If welding on metric or odd thickness, select the closest fractional equivalent.
- Tungsten Diameter. This helps to determine the maximum amperage that can be used with the given tungsten diameter. For example 1/16" electrodes will not be able to weld at a full 200A. In this case maximum Amperage will be capped unless a larger tungsten is used.

For Stick you'll need to know and enter the following:

- Electrode type (listed on the side of the electrode)
- Electrode diameter. This helps to determine minimum and maximum Amperage range of the electrode.
- Metal thickness. This helps the machine know what amperage to select given the electrode type and electrode diameter.

Keep in mind that the machine assumes that you are welding with either steel or stainless in DC TIG mode, and Aluminum in AC TIG mode. With more exotic metals or alloys, the Rapid Set mode may not be useful or accurate. Also remember that the machine will limit some choices while operating on 120V, and may limit Amp range with smaller diameter Tungsten electrodes and stick electrodes while operating on any voltage (120V or 240V).

You can always fine tune any recommended factory setting in Rapid set mode simply by turning the adjustment knob. You can increase the recommended factory setting up to 10A above the setting. Similarly, you can decrease the recommended factory setting by up to 10A. This allows for a total adjustment range of 20A total. In case you forget the recommended setting, the clock dial gauge indicates the programmed setting when the arrow points vertical and turns red. When increasing above or below the recommended factory setting the arrow will rotate right or left on the gauge and the arrow will turn white once the gauge leaves the factory recommended setting.

*Rapid Set only sets Amperage. It does not set any other setting.*

*You'll still need to set all other parameters before entering the Rapid Set mode such as pre/post flow, start/end amps, pulse, start type etc.*

## 26 Series Air-Cooled Welding Torch (Typical Type) Parts and Assembly.

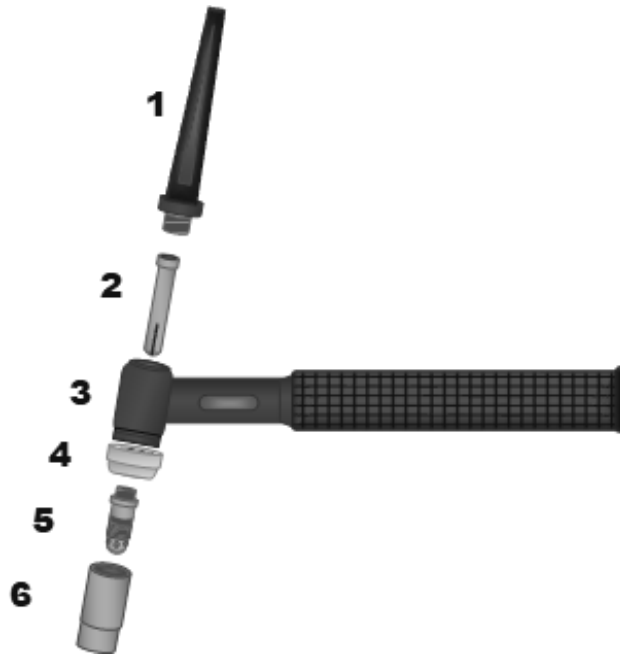

Typical Everlast and NOVA Torch Assembly (17,18, 26 Series)

(Some parts may not appear exactly the same but are equal in assembly order and type.)

Tungsten not included.

#	Description	Size/Type	Part#	Alternate Ref.	Note
1	Back Cap	Long	NVA57Y04-3	57Y02	
1	Back Cap	Medium	NVA41V35-3	41V35	Or 300M
1	Back Cap	Short	NVA57Y04-3	57Y04	
2	Collet	.040"	NVA10N22-3	10N22	1.0mm
2	Collet	1/16"	NVA10N23-3	10N23	1.6mm
2	Collet	3/32"	NVA10N24-3	10N24	2.4mm
2	Collet	1/8"	NVA10N25-3	10N25	3.2mm
3	Torch Body/Handle	17,26, or 18	Call for App.		Varies by Type
4	Heat Shield	17/26/18	NVA-HS172618	Heat Shield	Interchanges with similar aftermarket
5	Collet Body	Universal one size fits 1/16" to 1/8"	Stock	Stock	Universal Collet Body and Collets supplied with original starter kit
5	Collet Body	.040"	NVA-10N30	10N30	1.0mm, match to collet size
5	Collet Body	1/16"	NVA-10N31	10N31	1.6mm, match to collet size
5	Collet Body	3/32"	NVA10N	10N32	2.4mm, match to collet size
5	Collet Body	1/8"	NVA10N28	10N28	3.2mm, match to collet size
6	Cup	4	NVA-10N50-3	10N50	Standard, non gas lens 1/4"
6	Cup	5	NVA-10N49-3	10N49	Standard, non gas lens 5/16"
6	Cup	6	NVA-10N48-3	10N48	Standard, non gas lens 3/8"
6	Cup	7	NVA-10N47	10N47	Standard, non gas lens 7/16"
6	Cup	8	NVA-10N46-3	10N46	Standard, non gas lens 1/2"

# 7 PIN CONNECTOR

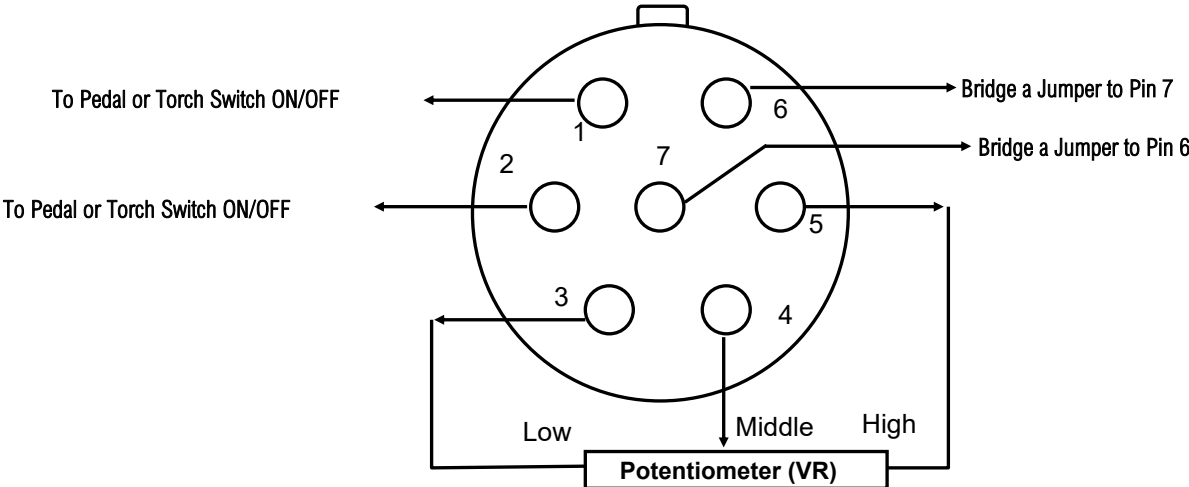

**Troubleshooting**

<b>Trouble/Description</b>	<b>Possible Cause</b>	<b>Solution</b>
Unit will not turn on. No lights on panel.	Unit Not plugged in. Bad Outlet Main Breaker tripped. Faulty welder switch.	Investigate cause and remedy. If switch is suspected contact Ahp. Check simplest issues first.
Unit switches on, no fan noise.	Faulty Fan motor or circuit	Contact Ahp.
Unit switches on, no weld or intermittent output. HF spark is present or weak	Disconnected work clamp or poor connection. TIG gas is turned off. TIG gas flow is too low.	Check and remedy. Put work clamp directly to the work piece. Do not run through table or other accessory. Check DINSE type connector for cable tightness. Test for stick function. If no stick function either, contact Ahp.
HF spark is absent, will not start arc, but can scratch or lift start arc.	Point gap issue. Bad HF board	Check for HF spark through vents in front panel. Check, clean and adjust point gap (contact Ahp if not sure).
Tungsten balls or is rapidly consumed. Porosity in weld.	Wrong Polarity. Wrong AC balance Bad or Wrong Shielding gas. Low gas flow rate. Welder is too close to weld area, gas is blown off weld. Draft.	Put torch in negative. Set Balance to 30%. Check to ensure gas is 100% Argon, and not mixed gas. Increase flow rate until porosity disappears (Usually 15 to 25 CFH, depending upon cup size/type). Move welder 6 to 8 ft away from weld area. Check for draft or breezes/open doors, or fans in area. Use a small tea light candle to test for drafts in weld area.
Unit TIG welds in DC but not in AC.	Wrong polarity, or wrong AC balance setting. Faulty AC inverter. Possibly contaminated gas (sometimes slight contamination will allow DC welding but not AC).	Check polarity. Put torch in negative. Set balance to 35%. Check for contaminated gas from supplier. Contact Ahp for other suspected issues.
Trouble Code	Various	Contact Ahp for diagnosis.

