

FA400-1101 SPEC SHEET

MAC FAUCETS

The Leader in Decorative Automatic Faucets Worldwide

Autoluxe Faucets Are Available In Twenty Finishes



Model: FA400-1101 For Vessel Sinks Only

Featuring:

- **Solid Brass Faucet.**
- **Solid Brass Valving System.**
- **Water Resistant Electronics.**
- **Battery Powered, with Optional AC.**
- **Available in Twenty (20) Finishes.**

The model FA400-1101 is specifically designed for vessel sink (bowl sink) applications. However, don't let the good looks fool you. The model FA400-1101 is a heavy duty faucet that is designed for heavy traffic applications. It features the Faucet Automator model FA400.

Manufactured to last, the FA400 employs the latest in plug and play digital electronics, solid brass solenoid valve with integral filter and water flow adjustment, and it all comes in a package that is a breeze to install

Package Includes

Faucet

FA400 Automator

*Single Water Source
Fitting*

**Please Note: Faucet
Sold Without Drain**

Stainless Steel Hose

Mounting Hardware

Batteries Pre-installed

*All the hardware necessary for
satisfactory installation*

ANSI A112.18.1M

CSA Standard B125, 2.2
U.S. GPM

Complies with NSF
Standard 61, Section 9



SPECIFICATIONS AND DIMENSIONS

MODEL:	FA400-1101
SPOUT:	SOLID BRASS
POWER:	4 (AA) BATTERIES / AC ADAPTER OPTIONAL
BATTERY LIFE EXPECTANCY:	200,000 CYCLES
WATER TEMPERATURE CONTROL:	OPTIONAL
SENSOR TYPE AND LOCATION:	ACTIVE INFRARED, BASE MOUNT
SENSOR MICROPROCESSOR:	DIGITAL, PUG AND PLAY
SENSING RANGE:	2" TO 8" ADJUSTABLE
RESPONSE TIME:	0.3 SECOND
SHUT-OFF DELAY TIME:	3 SECONDS
MAXIMUM RUNNING TIME:	60 SECONDS
AERATOR:	2.2 GPM STANDARD, OPTIONS AVAILABLE

Optional Equipment:

- Lavatory Drain, Grid and Pop-Up Type. • Adjustable Under the Sink
- Mixing Valve. • Matching Above The Sink Water Mixing Valve (**residential applications only**).
- Matching Soap Dispenser. • Matching Off-Body Pop-Up Lift (**residential applications only**).
- AC Adapters.

All Dimensions in Inches

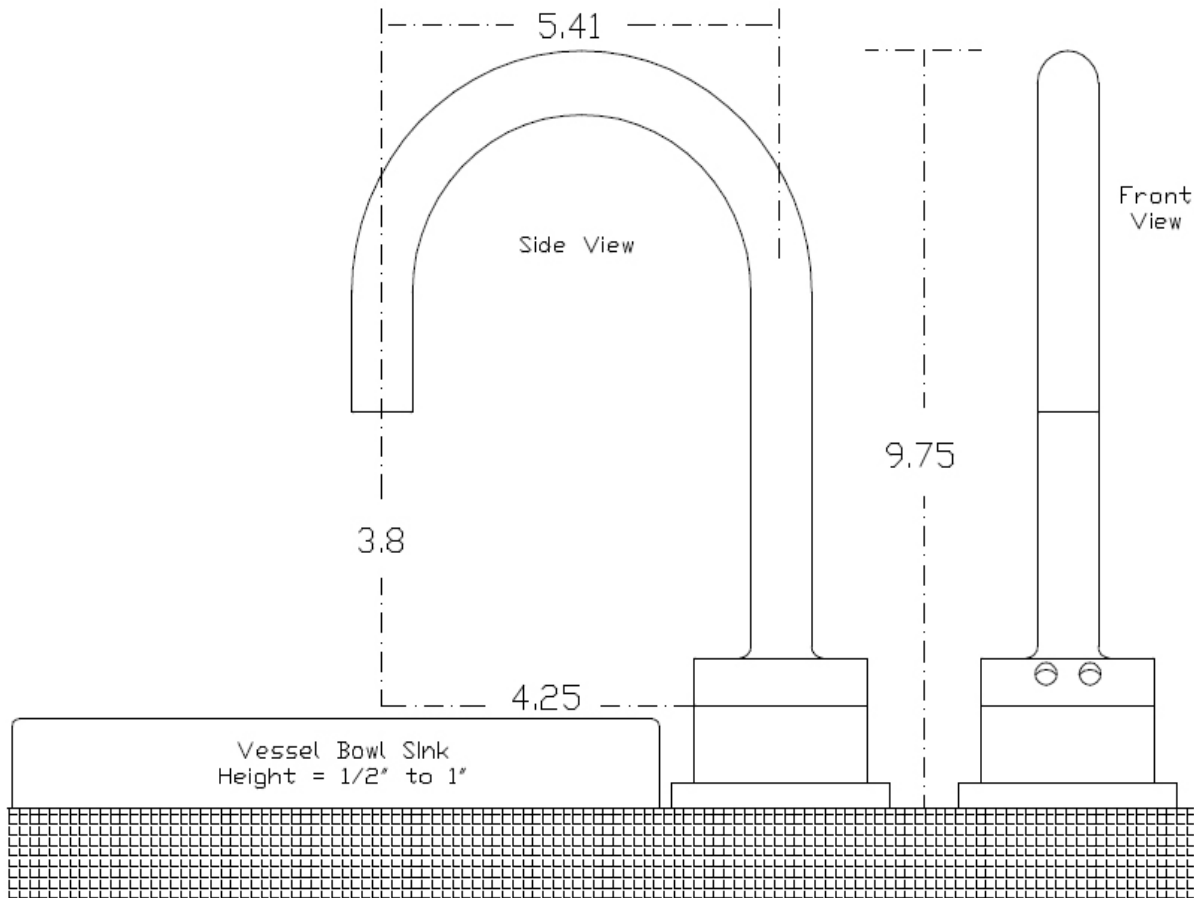

MAC Faucets 1289 North Post Oak Rd. Suite 160 Houston TX 77055

www.macfaucets.com Tel 713 316 9700 or 866 558 3200 Fax 310 919 3073 Email Info@macfaucets.com

MAC FAUCETS

Rough-in for Deck Mounted Faucets,
Water Mixing Valves, and Soap
Dispensers

Top View

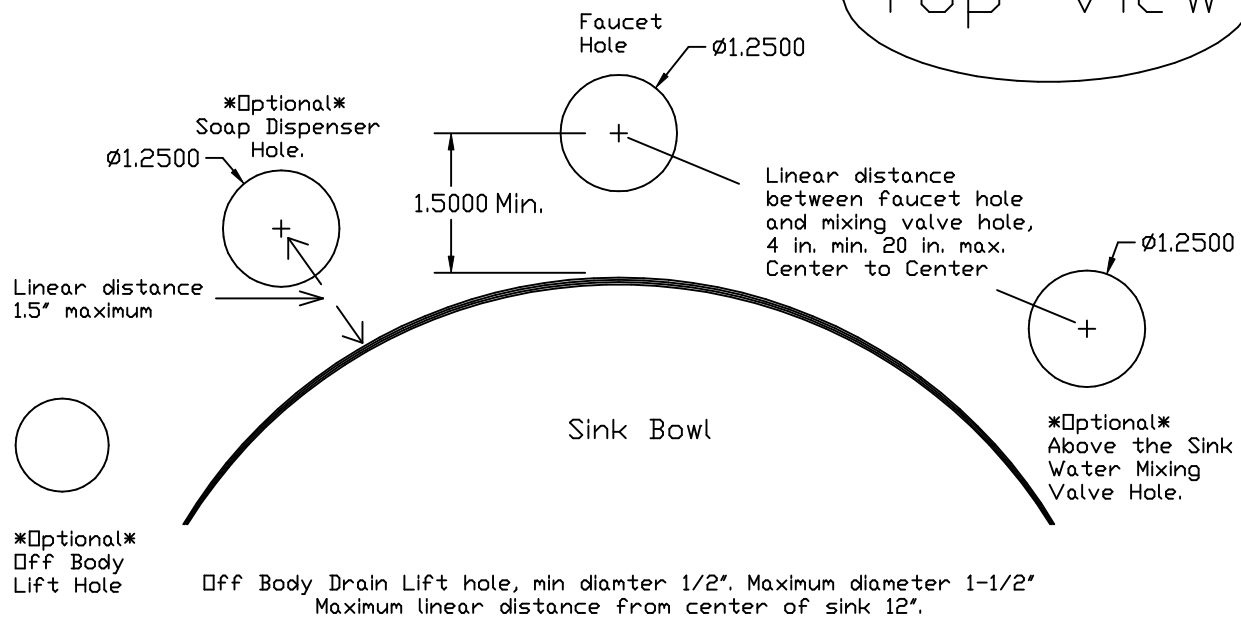

Side View

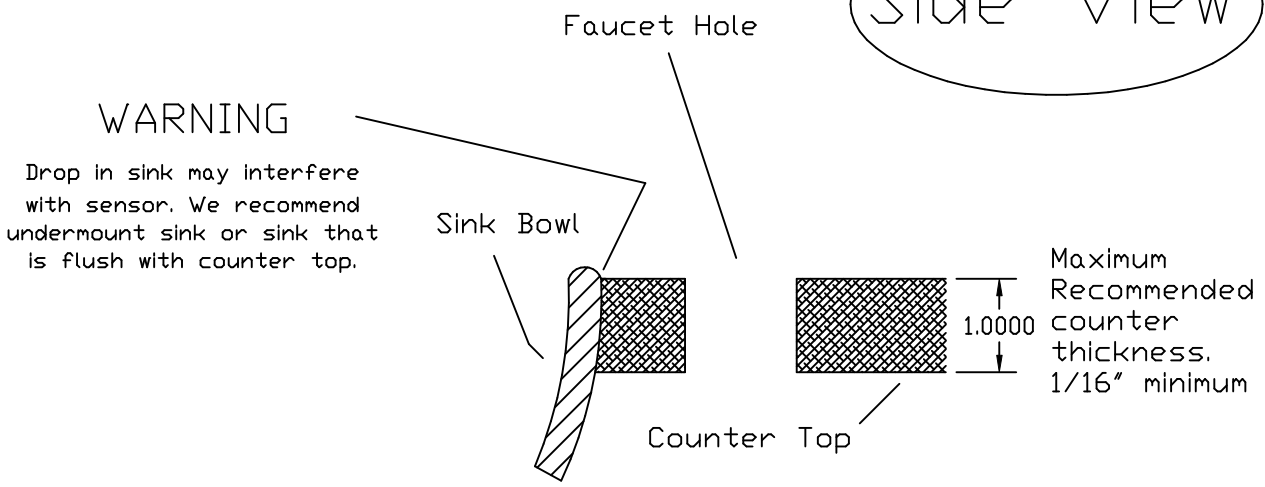

MAC FAUCETS

Rough-in for Deck Mounted Faucets,
Water Mixing Valves, and Soap
Dispensers

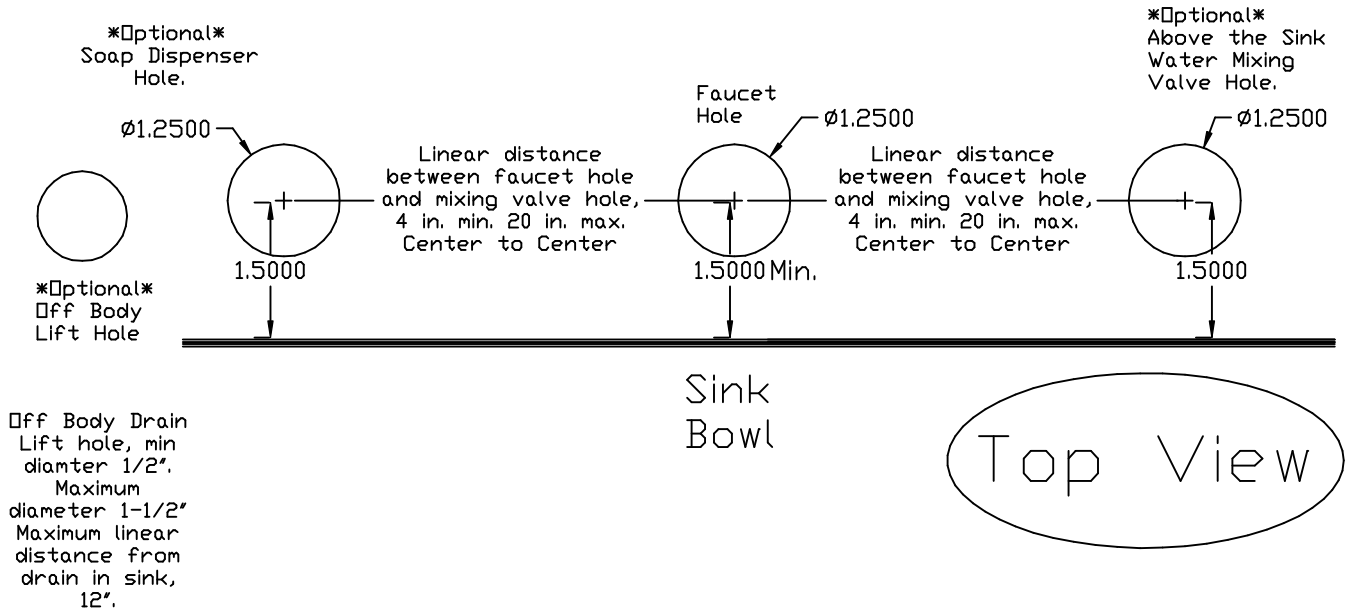

WARNING

Drop in sink may interfere with sensor. We recommend undermount sink or sink that is flush with counter top.

Sink Bowl

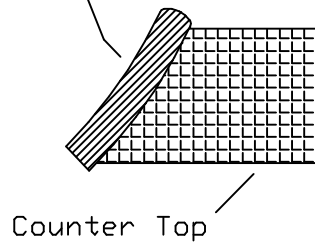

Side View

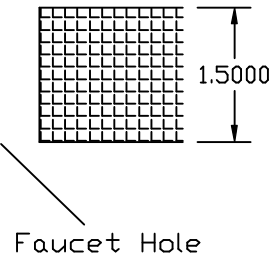

Recommended counter thickness. If thicker, please call MAC Faucets for verification.... 1/16" minimum