

FA400-118 SPEC SHEET



MAC FAUCETS

The Leader in Decorative Automatic Faucets Worldwide

Autoluxe Faucets Are Available In Twenty Finishes



Autoluxe™ Model: FA400-118

Featuring:

- **Solid Brass Faucet.**
- **Solid Brass Valving System.**
- **Resin Encased Control Electronics.**
- **Battery Powered, 4 Standard AA Batteries.**
- **Water Flow Adjustment Capability.**
- **Available in Twenty (20) Finishes.**

Package Includes

Faucet

FA400 Automator

*Single Water Source
Fitting*

*Water Flow Valve With
Built-in Particle Filter*

Stainless Steel Hose

Mounting Hardware

Batteries Pre-installed

*All the hardware necessary for
satisfactory installation*

Drain Sold Separately

ANSI A112.18.1M

CSA Standard B125, 2.2
U.S. GPM

Complies with NSF
Standard 61, Section 9



The model FA400-118 is ideal for bathroom applications where automatic faucets are an intricate component of the rooms overall design element. **The unique faucet is also available with optional matching water mixing valve and matching soap dispenser.** However, don't let the good looks fool you. The model FA400-118 is a heavy duty faucet that is designed for heavy traffic applications. It features the Faucet Automator model FA400. Manufactured to last, the FA400 employs the latest in plug and play digital electronics, solid brass solenoid valve with integral filter and water flow adjustment, and it all comes in a package that is a breeze to install.

MAC Faucets is first to develop and manufacture decorative hands free faucets World Wide.

SPECIFICATIONS AND DIMENSIONS

MODEL:	FA400-118
SPOUT:	SOLID BRASS
POWER:	4 (AA) BATTERIES / AC ADAPTER OPTIONAL
BATTERY LIFE EXPECTANCY:	300,000 CYCLES
SOLENOID VALVE:	6 VOLT MAGNET LATCHING
WORKING WATER PRESSURE:	1 PSI -100 PSI
SUPPLY INLET SIZE:	1/2" NPT MALE
WATER TEMPERATURE CONTROL:	OPTIONAL
POP-UP DRAIN ROD:	OPTIONAL
SENSOR TYPE AND LOCATION:	ACTIVE INFRARED, BASE MOUNT
SENSOR MICROPROCESSOR:	DIGITAL, PUG AND PLAY
SENSING RANGE:	2" TO 8" ADJUSTABLE
RESPONSE TIME:	0.3 SECOND
SHUT-OFF DELAY TIME:	2 SECONDS
MAXIMUM RUNNING TIME:	60 SECONDS
PARTICLE FILTER SIZE:	50 MICRON
AERATOR:	1.5 GPM STANDARD, OPTIONS AVAILABLE

Optional Equipment:

- Lavatory Drain, Grid and Pop-Up Type. • Adjustable Under the Sink
- Mixing Valve. • Matching Above The Sink Water Mixing Valve.
- Matching Soap Dispenser. • Matching Hole Cap Cover. • Matching Off-Body Pop-Up Lift. • AC Adapters.

All Dimensions in Inches

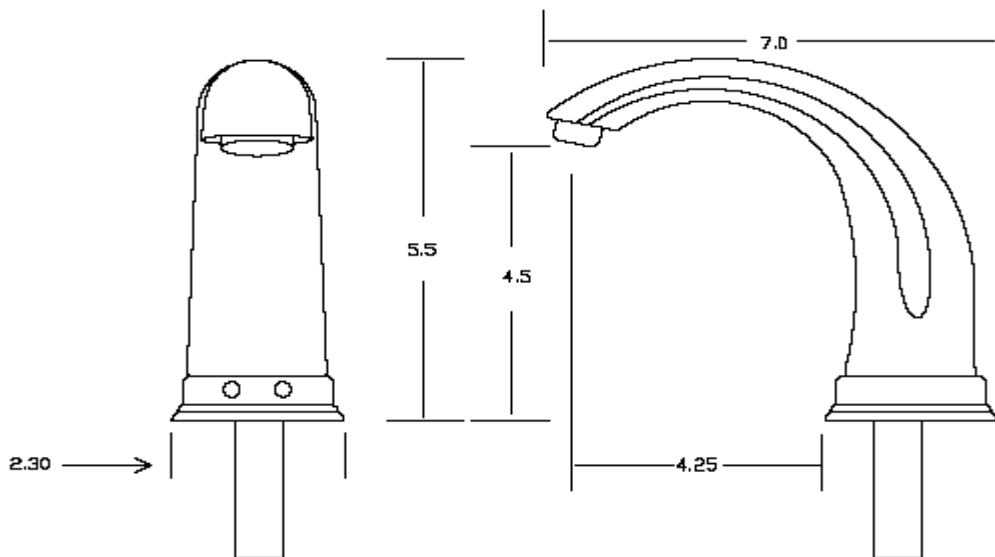

MAC FAUCETS

Rough-in for Deck Mounted Faucets,
Water Mixing Valves, and Soap
Dispensers

Top View

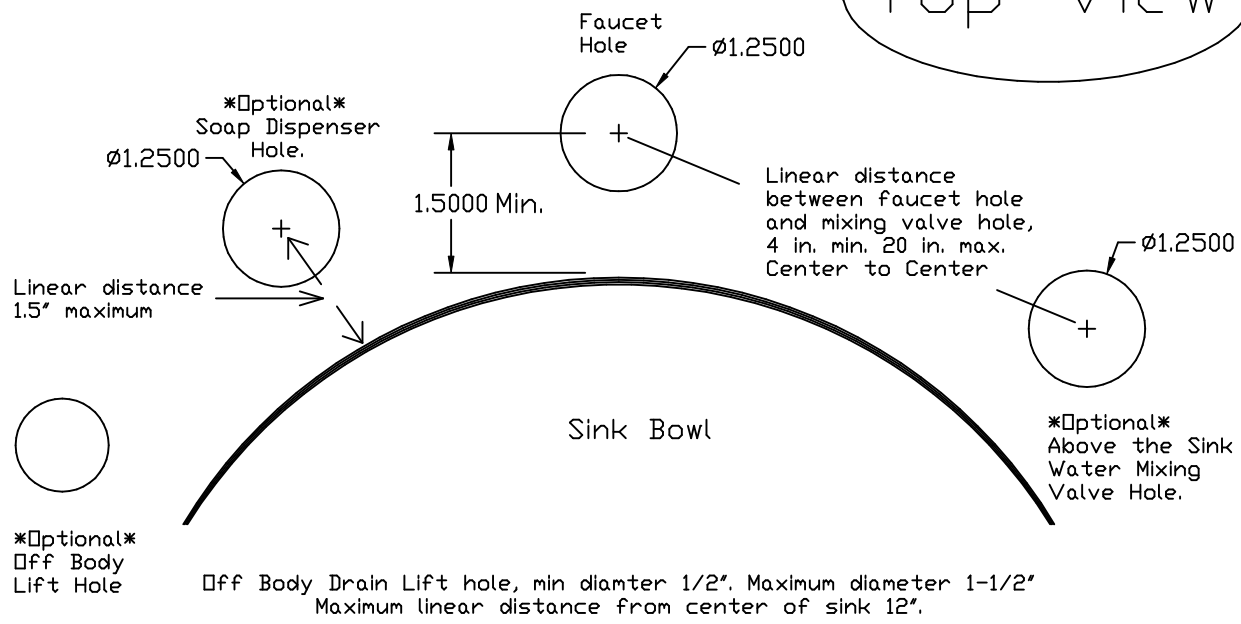

Side View

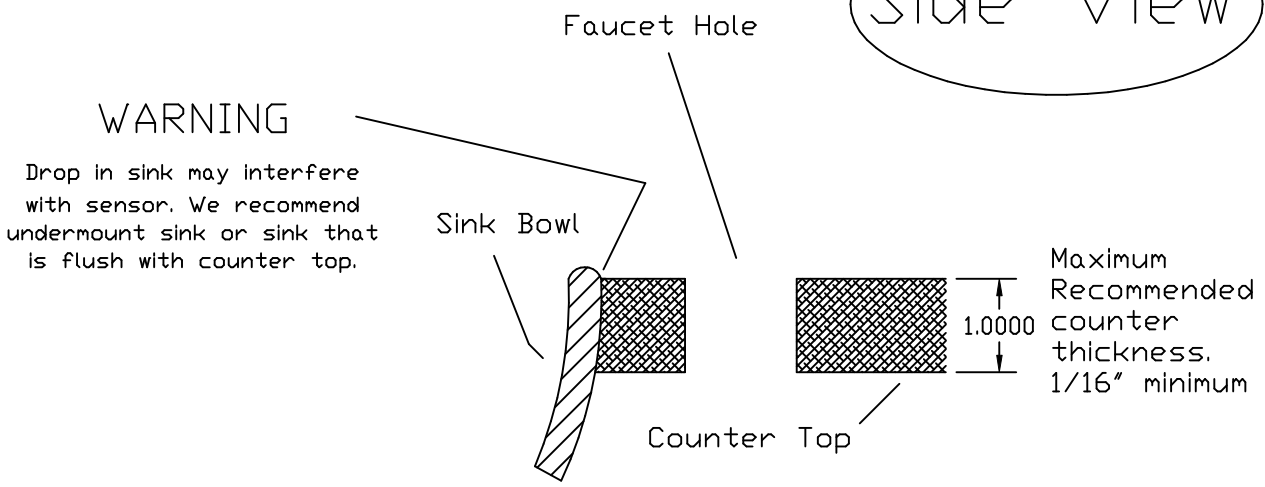

MAC FAUCETS

Rough-in for Deck Mounted Faucets,
Water Mixing Valves, and Soap
Dispensers

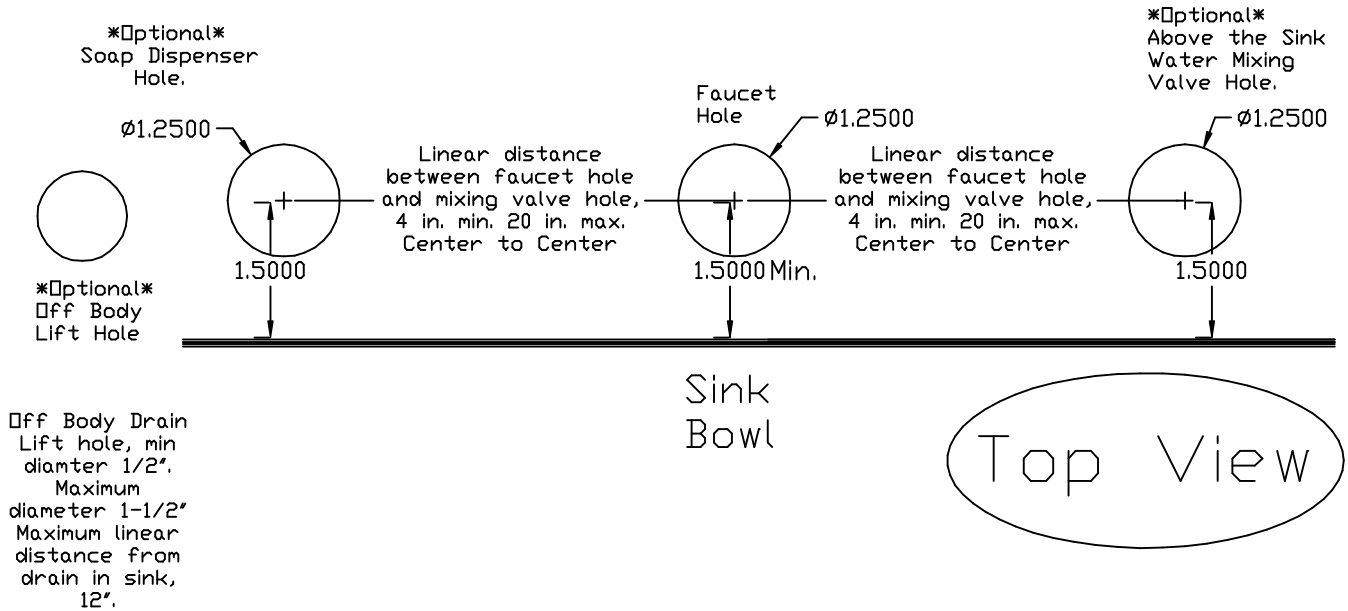

WARNING

Drop in sink may interfere with sensor. We recommend undermount sink or sink that is flush with counter top.

Sink Bowl

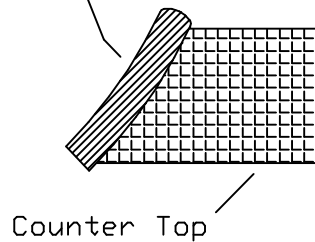

Side View

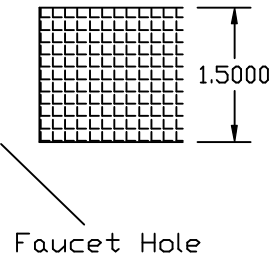

Recommended counter thickness. If thicker, please call MAC Faucets for verification.... 1/16" minimum