



MAC FAUCETS California, USA 866 558 3200 310 919 3073 Info@macfaucets.com www.macfaucets.com



ATD-10

Package Includes

- ✓ Automatic Paper Towel Dispenser
- ✓ Stainless Steel Construction
- ✓ Integral Battery Compartment
- ✓ Vandal Key
- ✓ Mounting Hardware
- ✓ **Batteries** (4 D size batteries)
- ✓ Fits rolls of 8" diameter x 8" long, core diameter 1-1/2" up to 2"
- ✓ All hardware necessary for satisfactory installation



Tools Needed

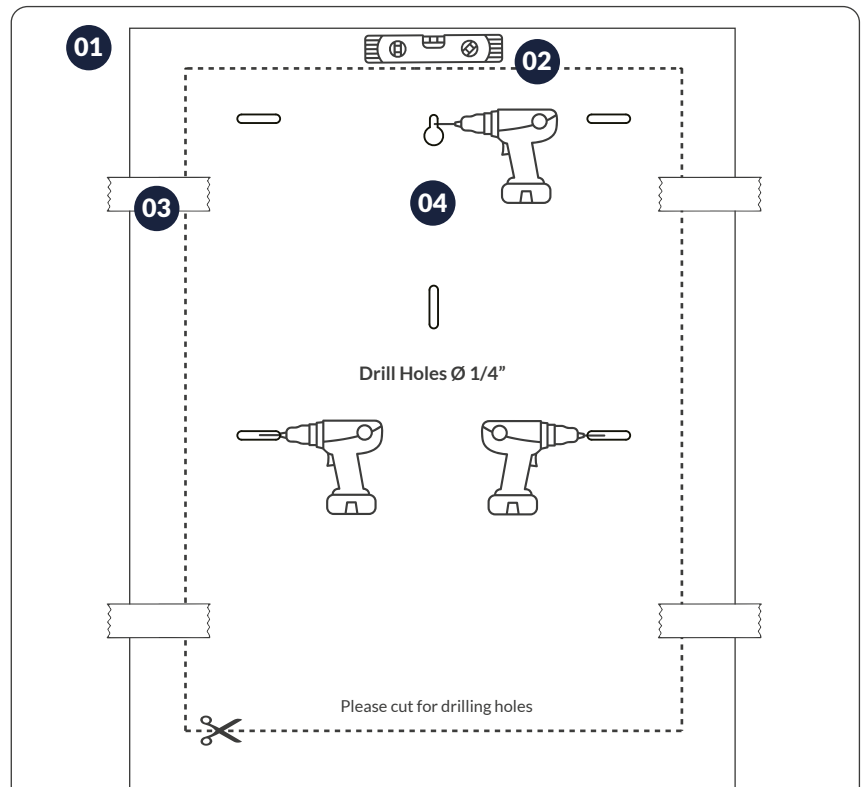
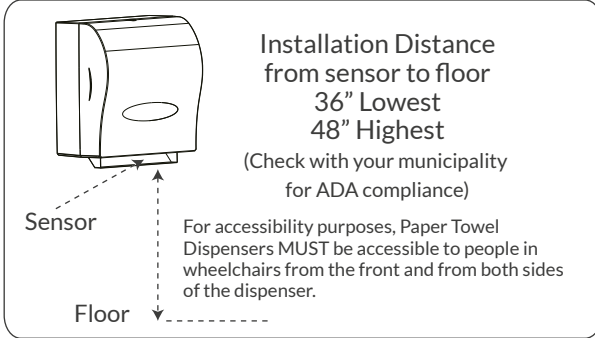
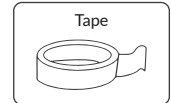
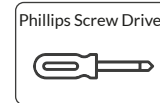
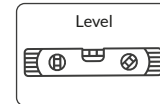
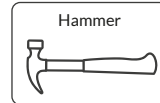

Once the location for the Paper Towel dispenser has been decided proceed with the installation steps below.

1. Use the template provided inside the box.
2. Use a level to insure that the template is straight and level.
3. Use painters tape to hold the template in place.
4. Drill holes for supplied plastic anchors.

Installation

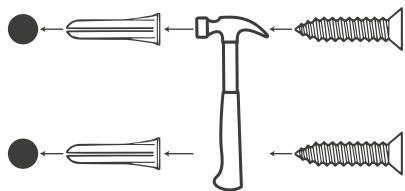

- 06** Place the plastic anchors in the holes and push them with the help of a lite hammer.

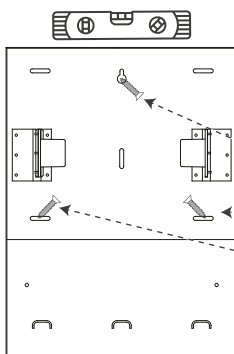

- 07** Affix the towel dispenser to the wall using the 3 supplied screws. Use a level to insure that the final installation will be straight and level. Fasten screws securely.

Installing Batteries

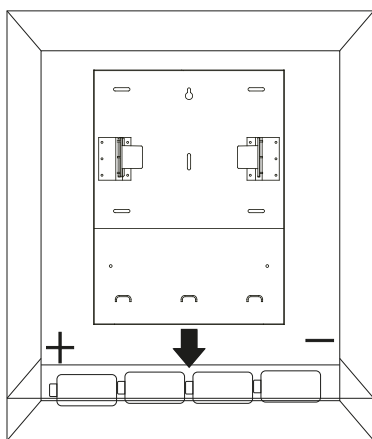

- 08** Insert (4) D cell batteries correctly

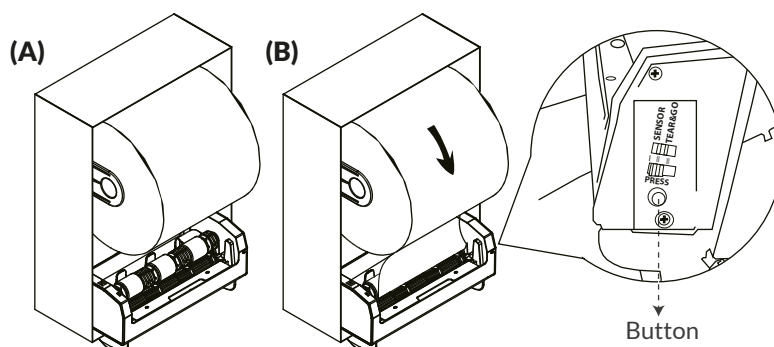

- 09** Load paper roll with the sheet as shown in Figures A and B above. Put the paper into the gap between rollers and press button at the right side of the dispenser for 1 second (BE CAREFUL NOT TO GET YOUR FINGERS CAUGHT BETWEEN THE ROLLERS) paper will start to load, release the button the loading will stop.

Switch & Button operation mode

The cover must be open to set up the switch and button these are located on the right side of the paper towel dispenser

Function: Sensor or Tear & Go settings

Sensor: Set the switch to the "sensor" position, the machine will dispense only when the hands are in the sensor area.

Tear & Go: Set the switch to "tear & go" position, the machine will dispense a piece of paper automatically according to the settings of the length of the paper, see settings below:

Paper Size Settings I: Paper Length 8"

Settings II: Paper Length 12"

Settings III: Paper Length 16"

Button: This button is for feeding paper to rollers see **09** above.

LED flashes indication:

- Cover open red and blue lights flash alternately. Red light flashes when the dispenser is out of paper
- Blue light flashes twice per 1 second indicates the paper is stuck by paper shafts, open the cover and clear the paper roll, so that the dispenser resumes the work.
- Red light flashes twice per 1 second implies paper is stuck by serrated blade from the paper exit, open cover to re-assemble the paper roll and close the cover to resume the work.
- Paper dispenser will work automatically once the cover is closed.

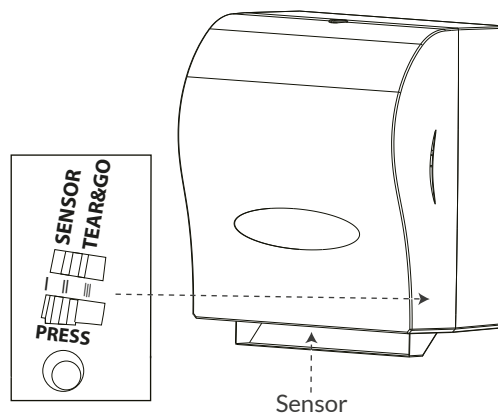

- NOTE:**
- In the "Sensor" mode, the dispenser will dispense one paper towel at a time, but only when hands are present under the sensor. For additional paper, remove hands for 3 seconds and repeat.
 - The default setting of the product is SENSOR, for "TEAR & GO" function, set switch to "TEAR & GO".
 - There should be no objects within 16" under the paper exit, to avoid the dispenser won't work.