

dadada[®]

JOLLY Crib

Assembly Instructions



dadada:

Your baby's first...

We believe every family deserves beautiful spaces, quality construction that spans generations, and the peace of mind that comes with knowing their baby is at the center of everything we do.

dadada is modern nursery furniture designed with baby's first moments in mind. From form to function, base materials to baby-safe finishes, each piece is created to grow alongside little ones and provide parents with a trusted foundation for their family's most precious memories.

what makes us special?



thoughtfully controlled manufacturing

all our cribs are manufactured in Italy in well-established, certified factories that use state-of-the-art modern technologies.



two warranty on our cribs

we guarantee the quality of our products and offer a limited warranty to protect you against product failure or damage.



baby-safe finishes

our paints and stains are ALWAYS lead and phthalate free, and meet strict juvenile and industry safety standards.



affordable luxury

we sell our modern, beautifully designed pieces at attainable prices because we believe that every baby deserves the absolute best in design.



sustainably minded, durable materials

we use hardwoods that are not only aesthetically beautiful, but also strong enough to last generations, reducing the amount of disposable furniture that finds its way to our landfills.



GREENGUARD Gold certified cribs

for indoor-air-emissions testing according to stringent requirements exceeding the State of California indoor air quality for schools and GSA standards.

learn more on our website





Before you start to assemble,
we highly recommend
watching the instructional
video on our website:
dadadababy.com

Your baby's first crib

dadada:
Your baby's first...

Jolly Crib

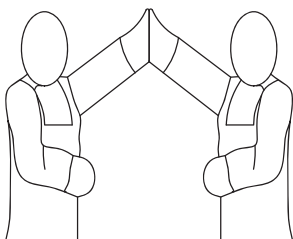



Thank you for purchasing our product. Please follow these assembly instructions carefully - they will save you time and make assembly easier and prevent possible damage to your new dadada furniture.

We strongly recommend assembling this unit on a soft surface, like carpet or a blanket.

When moving dadada furniture, always lift the product off the floor. Dragging or sliding the furniture can both damage the product and scratch your floors.



WARNING

- READ ALL INSTRUCTIONS BEFORE USING THIS PRODUCT.
- KEEP THESE INSTRUCTIONS FOR FUTURE USE.
- FAILURE TO FOLLOW THESE WARNINGS AND INSTRUCTIONS COULD RESULT IN SERIOUS INJURY OR DEATH.
- INFANT CAN SUFFOCATE ON SOFT BEDDING. NEVER ADD A PILLOW OR COMFORTER IN CRIB WITH INFANT OR PLACE ADDITIONAL PADDING UNDER AN INFANT.
- TO REDUCE THE RISK OF SIDS, PEDIATRICIANS RECOMMEND HEALTHY INFANTS BE PLACED ON THEIR BACKS TO SLEEP, UNLESS OTHERWISE ADVISED BY YOUR PHYSICIAN.

ANY MATTRESS USED IN THIS CRIB MUST BE AT LEAST 27 1/4 INCHES (69 CM) BY 51 5/8 INCHES (131 CM) WITH A THICKNESS NOT EXCEEDING 6 INCHES (15 CM). THE DIMENSIONS OF THE MATTRESS SHALL BE TAKEN FROM SEAM TO SEAM OR EDGE TO EDGE WHERE APPROPRIATE.



CAUTION

- **Strangulation Hazard:** Strings can cause strangulation! DO NOT place items with a string around a child's neck, such as hood strings or pacifier cords. DO NOT place cords, straps, or similar items that could become wound around the child's neck in or near this crib. DO NOT suspend strings over a crib or attach strings to toys.
- To help prevent strangulation tighten all fasteners. A child can trap parts of the body or clothing on loose fasteners.
- DO NOT place a crib near a window where cords from blinds or drapes may strangle a child. DO NOT place this crib near a window or a patio door where a child could reach the cord of a blind or curtain and be strangled.
- **Fall Hazard:** When a child is able to pull to a standing position, set the mattress to the lowest position and remove bumper pads, large toys and other objects that could serve as steps for climbing out.
- DO NOT use this crib if the child is able to climb out unaided or is taller than 35 in. (89cm).
- Check this product for damaged hardware, loose joints, loose bolts or other fasteners, missing parts or sharp edges before and after assembly and frequently during use. Securely tighten loose bolts and other fasteners. DO NOT use crib if any parts are missing, damaged or broken. DO NOT substitute parts. Contact **dadada Baby** for replacement parts and instructional literature if needed.
- Store crib in a clean, dry place. Use caution as extreme changes in temperature or humidity can compromise the quality.
- Avoid using vaporizers or humidifiers for prolonged periods of time.
- DO NOT use a water mattress with this crib.
- If refinishing, use a non-toxic finish specified for children's products.
- Never use plastic shipping bags or other plastic films as mattress covers because they can cause suffocation.
- Infants can suffocate in gaps between crib sides when used with a mattress that is too small.
- Follow warnings on all products in a crib.
- Ensure that the sides are properly latched or locked in place when the crib is occupied.
- The mattress used with this crib should not be more than 15cm thick and should be of such length with width that the gap between the mattress and the sides of the crib is no more than 3cm when the mattress is pushed into the corner of the crib.

Website: dadadababy.com

Phone number: (800) 722-5798

Email address: service@dadadababy.com

Parts List

Please check to make sure you have all parts listed here before assembling. For any missing or faulty parts, please contact our Customer Care team. Customer Care contact info can be found on the last page of this manual. Hardware kit included, no additional tools needed for assembly. Do not use an electric screwdriver.

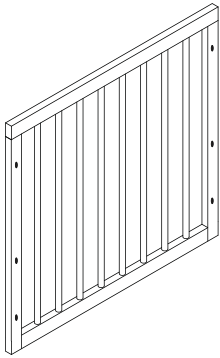

A x2

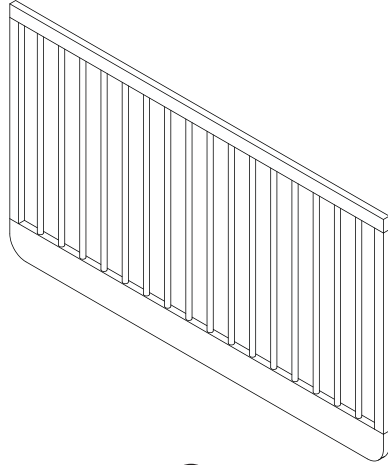

B x2

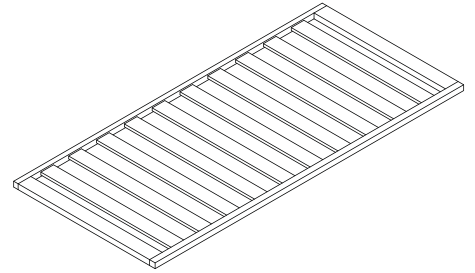

C x1

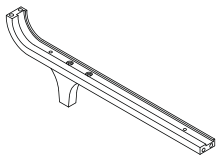

D x2

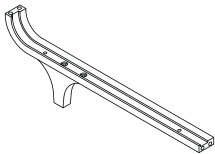

E x2

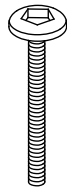

6x45

F x8

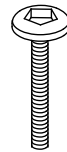

6x35

G x8

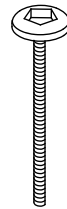

5x50

H x4

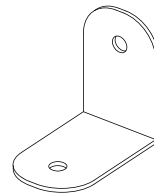

I x4



J x4

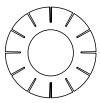

K x24

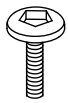

6x15

L x4

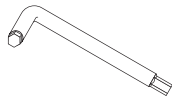

M x1



wood pin
épingle en bois

N x10



Q x2



R x2



S x2



T x1

optional
sold separately
SKU:1023880008125



O x1

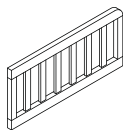

P x1

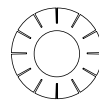

K x2

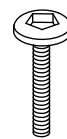

F x2

1

Q x2  **S** x2  **R** x2  **N** x2 

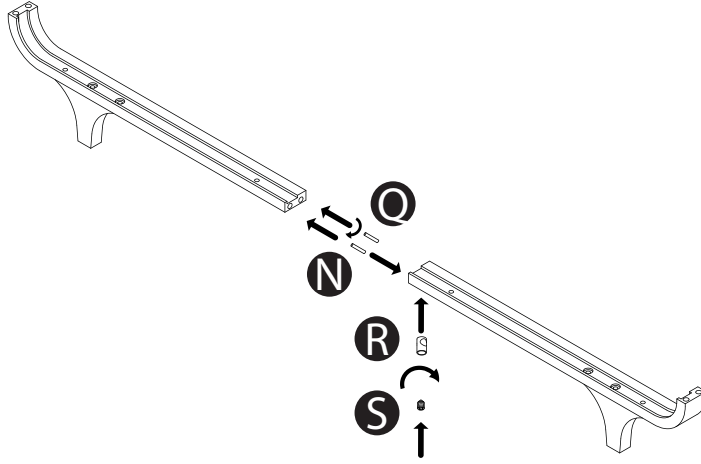

2

G x8  **K** x8 

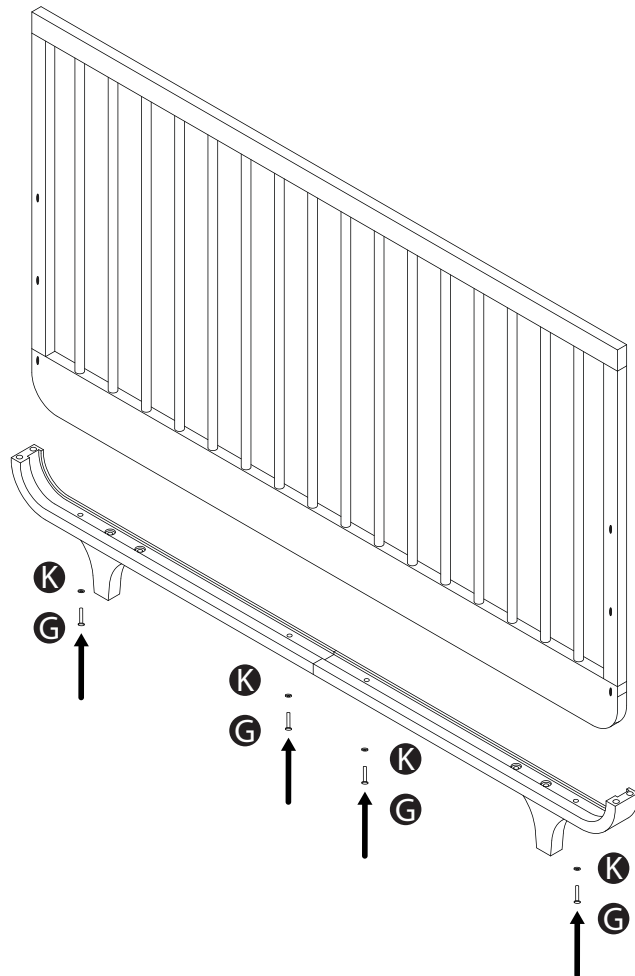

3

L x4

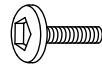

K x4

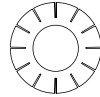

I x4

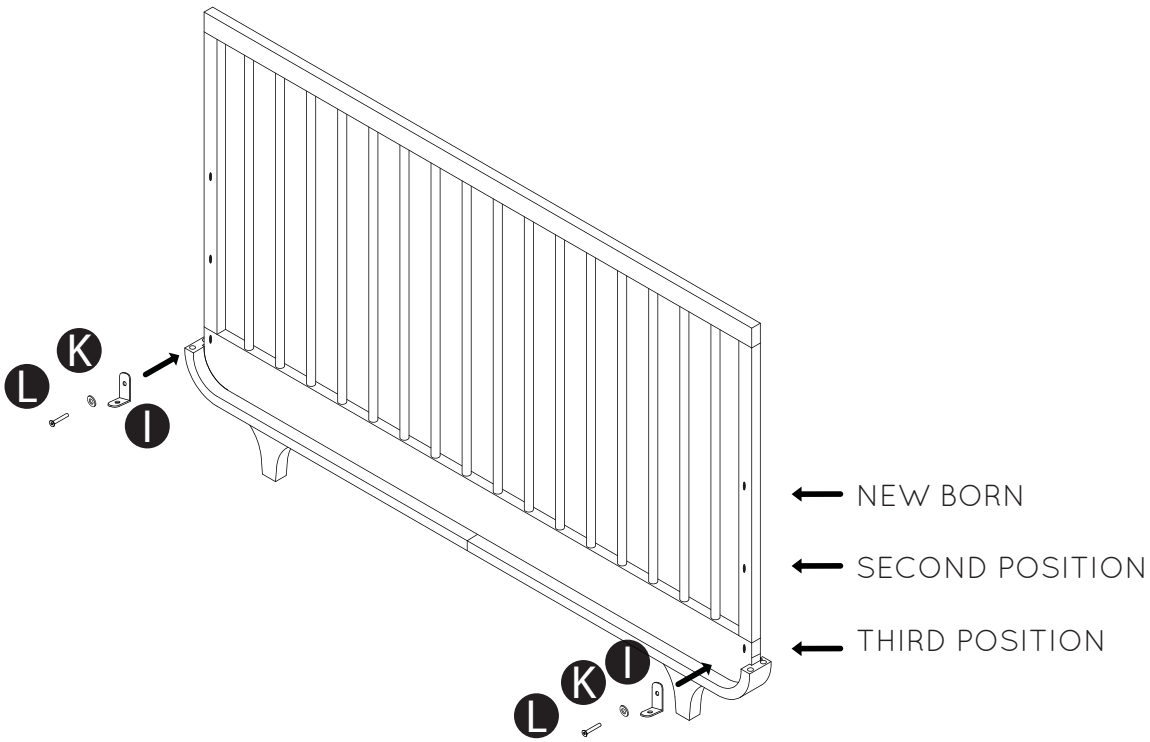
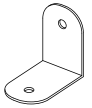

4

N x8

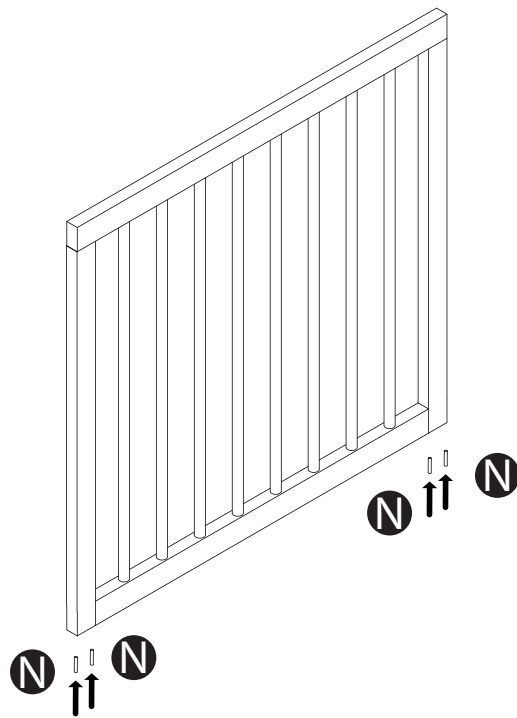

5

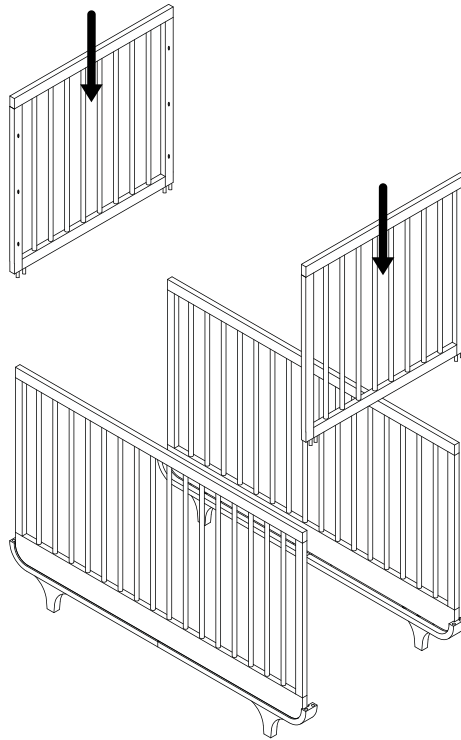

6

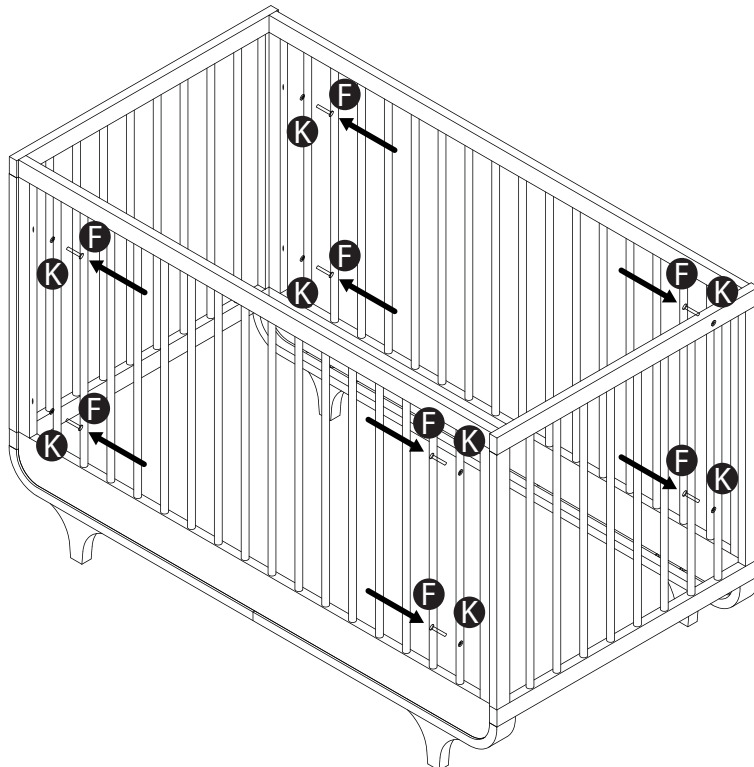

7

H x4



J x4



K x4

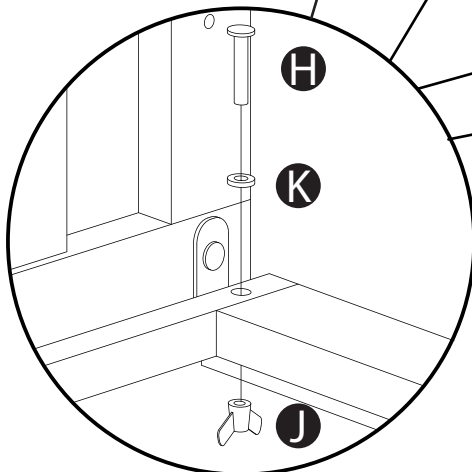
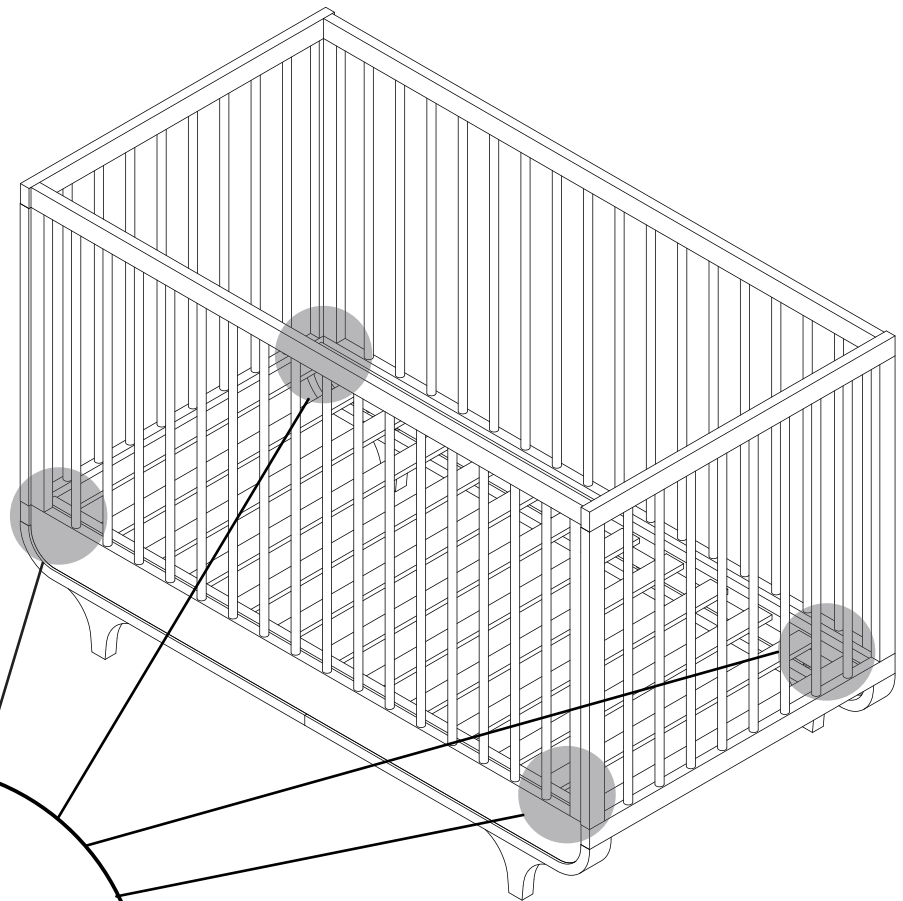
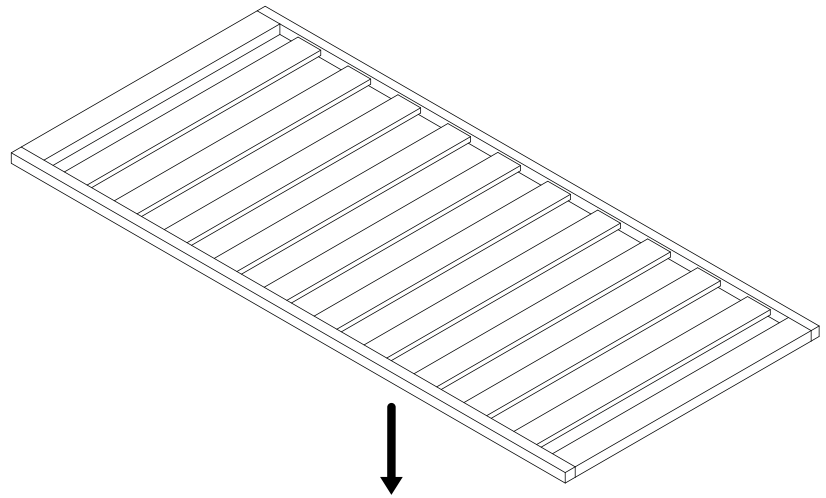
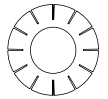

Finish



Thank you

for choosing dadada Baby

We hope you enjoy your new product. We would love to hear about your baby's first moments.

Be sure to tag @dadadababyusa and use #dadadamoments

If there is anything we can improve upon, we would love to know!
You can reach out to our team directly

Website: dadadababy.com

Phone number: (800) 722-5798

Email address: service@dadadababy.com



Before you start to assemble, we highly recommend watching the instructional video on our website: dadadababy.com

Your baby's first toddler bed

crib conversion kit sold separately

dadada;
Your baby's first...

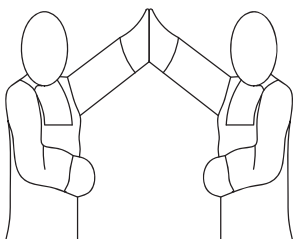

ANY MATTRESS USED IN THIS CRIB MUST BE AT LEAST 27 1/4 INCHES (69 CM) BY 51 5/8 INCHES (131 CM) WITH A THICKNESS NOT EXCEEDING 6 INCHES (15 CM). THE DIMENSIONS OF THE MATTRESS SHALL BE TAKEN FROM SEAM TO SEAM OR EDGE TO EDGE WHERE APPROPRIATE.



WARNING

FOR TODDLER BED USE

- READ ALL INSTRUCTIONS BEFORE ASSEMBLING TODDLER BED.
- KEEP THESE INSTRUCTIONS FOR FUTURE USE.
- FAILURE TO FOLLOW THESE WARNINGS AND INSTRUCTIONS COULD RESULT IN SERIOUS INJURY OR DEATH FROM ENTRAPMENT OR STRANGULATION.
- THE MINIMUM AGE OF USER SHALL NOT BE LESS THAN 15 MONTHS AND THE MAXIMUM WEIGHT SHALL NOT BE GREATER THAN 50 LB (22.7 KG).
- GUARDRAIL (SOLD SEPARATELY) MUST BE USED WHEN CRIB IS BEING USED AS A TODDLER BED TO AVOID THE FORMATION OF A GAP BETWEEN THE MATTRESS AND THE BED THAT COULD CAUSE AN ENTRAPMENT.
- DISPOSE OF ALL PACKAGING AND PLASTIC BAGS
- PREVENT BURNS, KEEP BED AWAY FROM OPEN FIRES AND OTHER HEAT SOURCES.

INFANTS HAVE DIED IN TODDLER BEDS FROM ENTRAPMENT

- OPENINGS IN AND BETWEEN BED PARTS CAN ENTRAP HEAD AND NECK OF SMALL CHILD
- NEVER USE BED WITH CHILDREN YOUNGER THAN 15 MONTHS



CAUTION

- **Strangulation Hazard:** Strings can cause strangulation! DO NOT place items with a string around a child's neck, such as hood strings or pacifier cords. DO NOT place cords, straps, or similar items that could become wound around the child's neck in or near this toddler bed. DO NOT suspend strings over toddler bed or attach strings to toys.
- To help prevent strangulation tighten all fasteners. A child can trap parts of the body or clothing on loose fasteners.
- DO NOT place this toddler bed near a window or a patio door where a child could reach the cord of a blind or curtain and be strangled.
- Check this product for damaged hardware, loose joints, loose bolts or other fasteners, missing parts or sharp edges before and after assembly and frequently during use. Securely tighten loose bolts and other fasteners. DO NOT use toddler bed if any parts are missing, damaged or broken. DO NOT substitute parts. Contact **dadada Baby** for replacement parts and instructional literature if needed.
- Store toddler bed in a clean, dry place. Use caution as extreme changes in temperature or humidity can compromise the quality.
- Avoid using vaporizers or humidifiers for prolonged periods of time.
- DO NOT use a water mattress with this toddler bed.
- If refinishing, use a non-toxic finish specified for children's products.
- Never use plastic shipping bags or other plastic films as mattress covers because they can cause suffocation.
- Infants can suffocate in gaps between crib sides when used with a mattress that is too small.
- Follow warnings on all products in a toddler bed.
- The mattress used with this toddler bed should not be more than 15cm thick and should be of such length with width that the gap between the mattress and the sides of the crib is no more than 3cm when the mattress is pushed into the corner of the toddler bed.

Website: dadadababy.com

Phone number: (800) 722-5798

Email address: service@dadadababy.com

1

Unscrew mattress base and one side

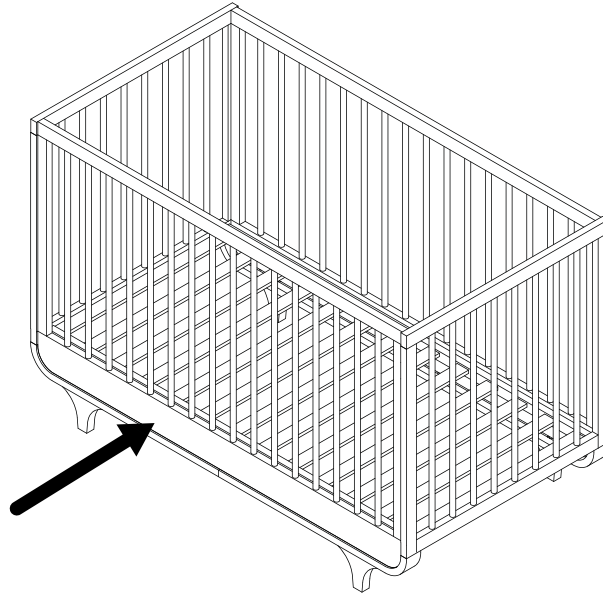

2

L x2 K x2 I x2

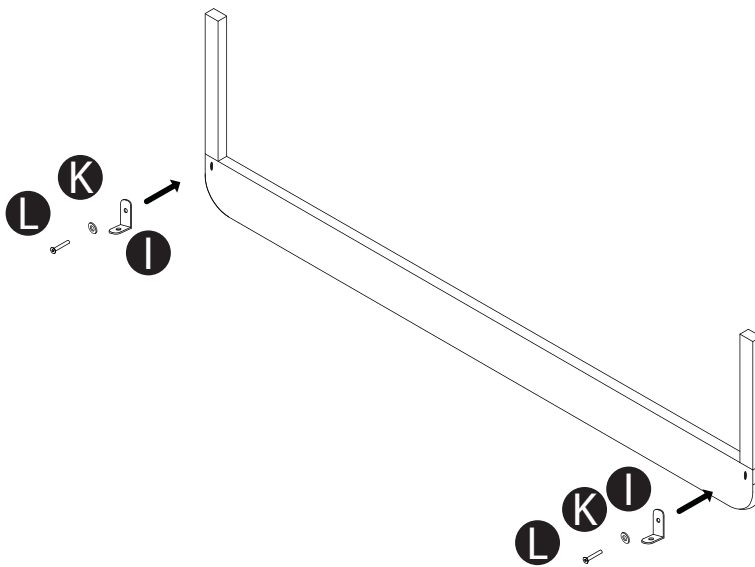

3

F x4

G x4

K x8

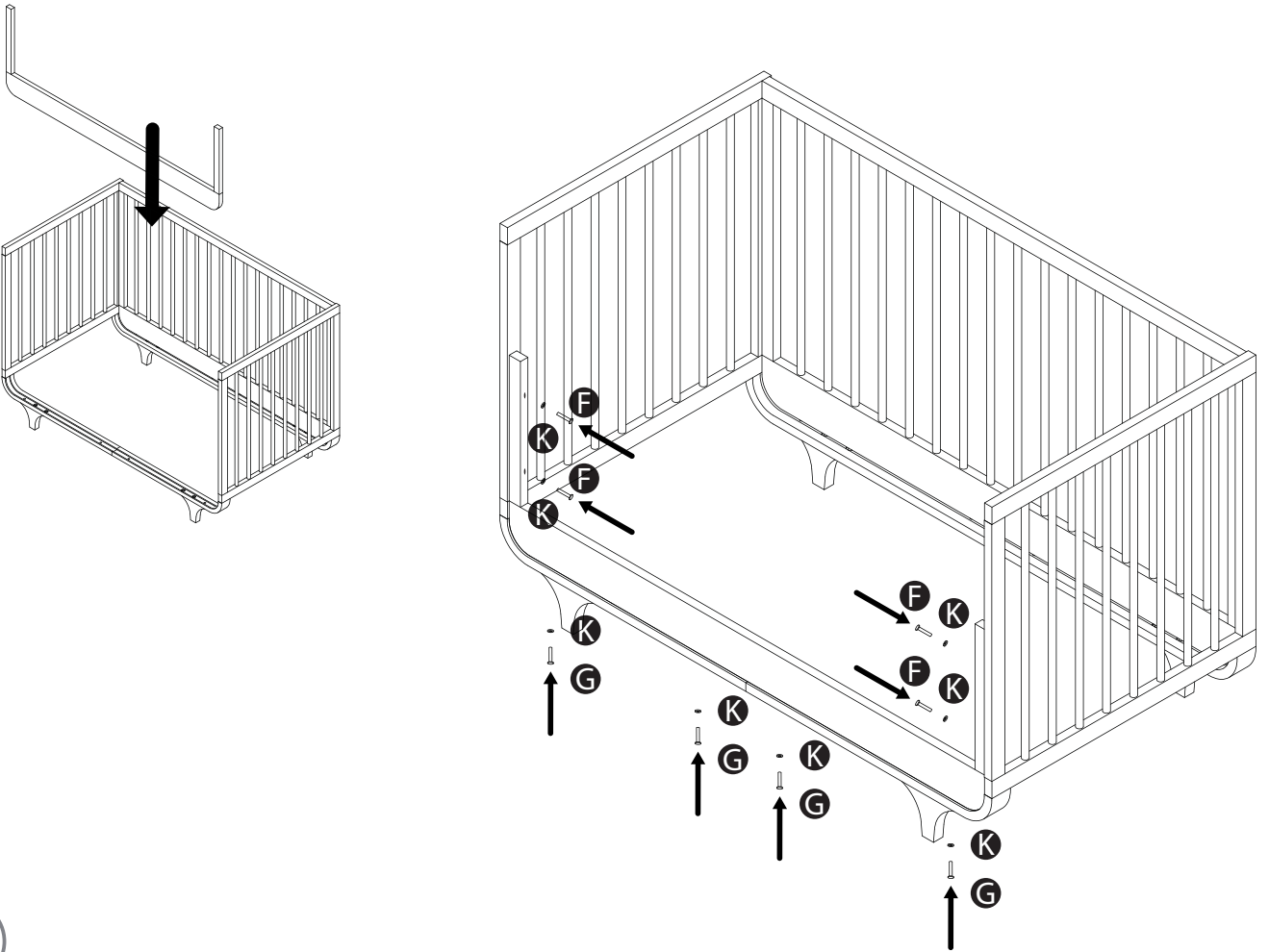
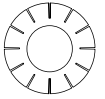

4

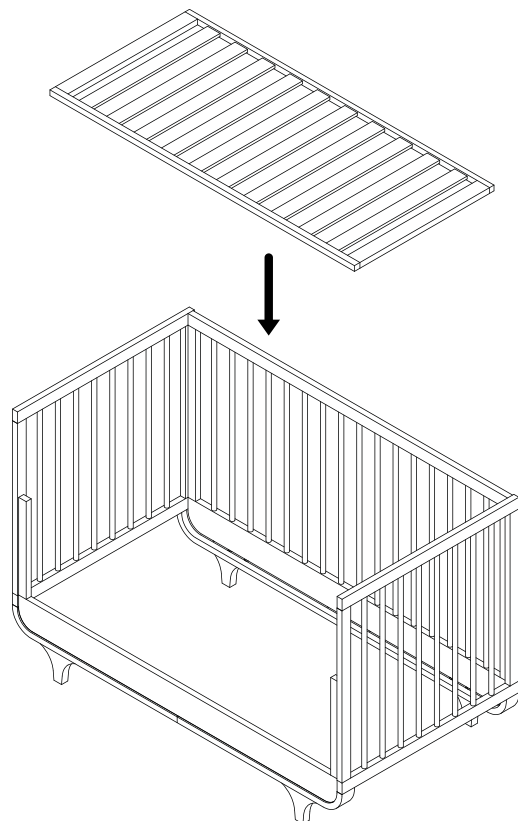

5

H x4



J x4



K x4

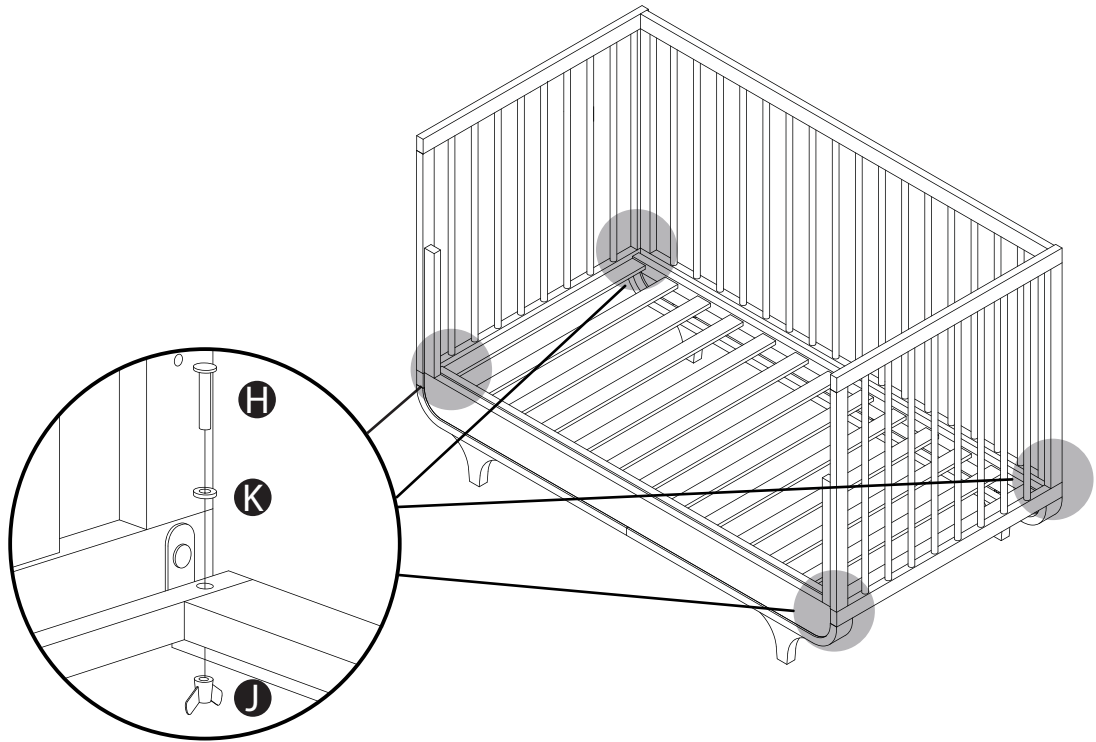
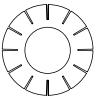

6

F x2

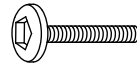

K x2

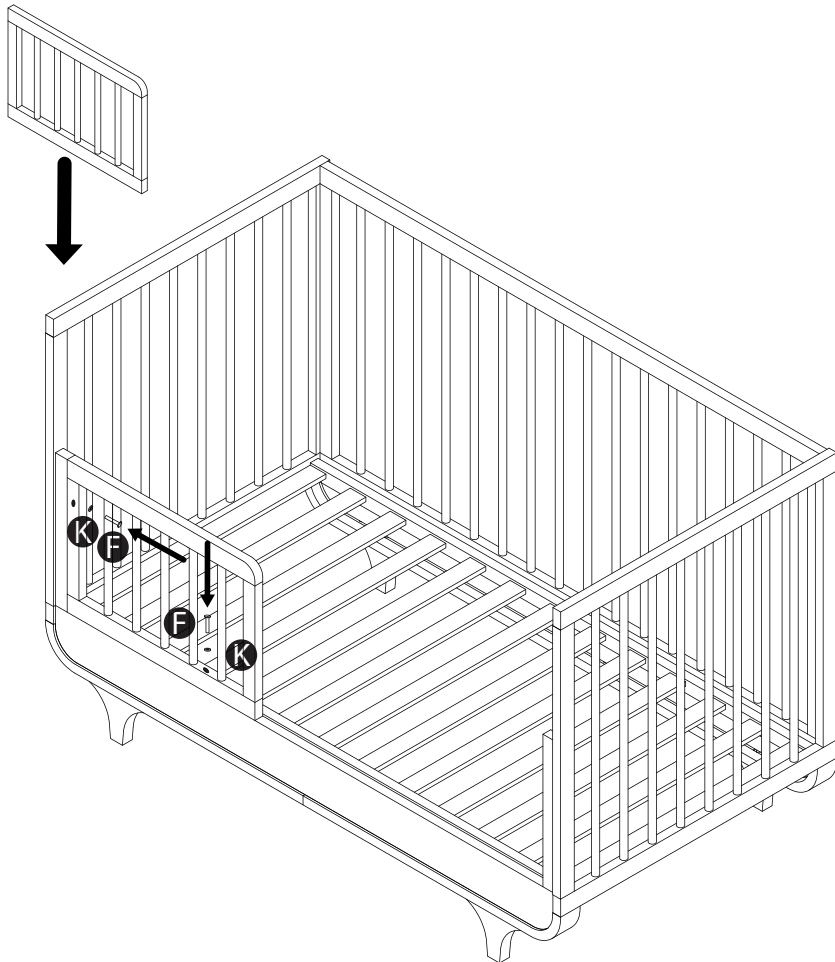
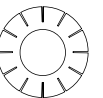

Finish



Thank you

for choosing dadada Baby

We hope you enjoy your new product. We would love to hear about your baby's first moments.

Be sure to tag @dadadababyusa and use #dadadamoments

If there is anything we can improve upon, we would love to know!
You can reach out to our team directly

Website: dadadababy.com
Phone number: (800) 722-5798
Email address: service@dadadababy.com

Care / Cleaning / Maintenance

- Regular care, cleaning, and maintenance will extend the life of your furniture.
- dadada furniture should not be exposed to direct sunlight, extreme temperatures, or moisture, as this can result in irreparable damage. Place crib away from heating or air-conditioning vents.
- In case of water splashes, remove water immediately and wipe.
- If cleaning is needed, use only a soft, clean cloth, lightly dampened with water. Clean the crib with a mild wood polish if required.
- Never use abrasive agents or solvents.
- Do not scrub, scratch, or chip the finish.
- Limits of warranty: The use of cleaning agents such as chemicals, scouring powders, or other aggressive formulas can damage the furniture and will void the warranty.

Limited Warranty

- We guarantee this product for a period of 2 years from date of purchase.
- The warranty covers any product failure which may occur due to manufacturing fault.
- The warranty does NOT include normal wear and tear, or parts that are damaged due to incorrect installation and assembly, misuse, or neglect.
- The specific legal rights of this warranty may vary from state to state.
- Some states do not allow any exclusion or limitation of incidental damages.
- Some states do not allow limitation on how long an implied warranty lasts.



2-year warranty

dadada®

Customer Service

For any missing or faulty parts:

Please re-check your packaging to ensure that parts are missing, then contact our Customer Care team using the contact info below.

Our Care team will need the following information:

- Copy of your receipt
- Model number of the unit purchased
- Description/part number of the missing or faulty part
- Quantity of the parts needed

dadada Customer Care team contact information:

Website: dadadababy.com

Phone number: (800) 722-5798

Email address: service@dadadababy.com

follow us on instagram

@dadadababyusa

